



# ORGANIC CHEMISTRY

VOLUME TWO

STEREOCHEMISTRY  
AND THE CHEMISTRY  
OF NATURAL PRODUCTS

by

I. L. FINAR

B.Sc., Ph.D.(Lond.), A.R.I.C.

*Senior Lecturer in Organic Chemistry,  
Northern Polytechnic, Holloway, London*

WITHDRAWN  
FROM STOCK



LONGMANS

LONGMANS, GREEN AND CO LTD  
48 Grosvenor Street, London W.1  
*Associated companies, branches and representatives  
throughout the world*

*Second and Third Editions © I. L. Finar, 1959 and 1964*

*First Published 1956  
Second Impression 1958  
Second Edition 1959  
Second Impression 1960  
Third Edition 1964*

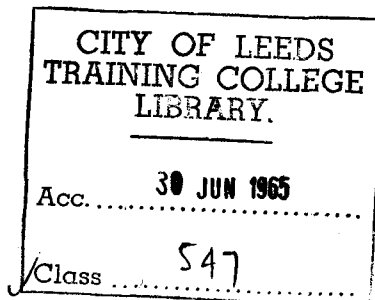

Printed in Great Britain by Butler & Tanner Ltd, Frome and London

## PREFACE TO THIRD EDITION

THIS third edition has been revised to bring it up to date. This has been made possible by the information I have obtained from articles written by experts on important developments in their field of research. Since the volume of research published on topics dealt with (and not dealt with) in this book make it impossible to include all new work, I have therefore had to choose, but any deficiencies in my choice are, I hope, partly compensated by the reading references given at the end of each chapter.

Chapter III has been rewritten (and renamed), but the section on transition state theory of reactions has been omitted; it has now been included in Volume I (4th ed., 1963). Expanded topics include nuclear magnetic resonance, correlation of configurations, conformational analysis, molecular overcrowding, the Beckmann rearrangement, nucleophilic substitution at a saturated carbon atom, elimination and addition reactions, carotenoids, penicillins, amino-acids, biosynthesis, etc. Some additions are rotatory dispersion, electron spin resonance, specification of absolute configurations, Newman projection formulæ, neighbouring group participation, the Wagner-Meerwein rearrangement, sesquiterpenes, etc.

I. L. FINAR

1964

## PREFACE TO SECOND EDITION

THIS volume has now been revised to bring it up to date; this has involved the expansion of some sections and the addition of new material. It may be useful if I indicate briefly the more important changes I have made in this new edition. Two major additions are conformational analysis and biosynthesis: in each case I have given an introduction to the problem, and have also discussed various applications. Some other additions are nuclear magnetic resonance, correlation of configurations, *isoflavones*, and vitamin B<sub>12</sub>. Expanded topics include dipole moments, molecular rotation, optical isomerism, steric effects (including steric factors and the transition state, molecular overcrowding), ascorbic acid, structure and synthesis of cholesterol, vitamin A<sub>1</sub>, polypeptides, mechanism of enzyme action, flavones, streptomycin and patulin.

I wish to thank those reviewers and correspondents who have pointed out errors and have made suggestions for improving the book.

I. L. FINAR

1958

## PREFACE TO FIRST EDITION

IN the Preface of my earlier book, *Organic Chemistry*, Longmans, Green (1954, 2nd ed.), I expressed the opinion that the chemistry of natural products is the application of the principles of Organic Chemistry. The present work is, in this sense, a continuation of my earlier one. It is my belief that a student who has mastered the principles will be well on the road to mastering the applications when he begins to study them. At the same time, a study of the applications will bring home to the student the dictum of Faraday: "Ce n'est pas assez de savoir les principes, il faut savoir *Manipuler*" (quoted by Faraday from the *Dictionnaire de Trevoux*).

In the sections on Stereochemistry, I have assumed no previous knowledge of this subject. This has meant a certain amount of repetition of some of the material in my earlier book, but I thought that this way of dealing with the subject would be preferable, since the alternative would have led to discontinuity. I have omitted an account of the stereochemistry of co-ordinated compounds since this subject is dealt with in textbooks on Inorganic Chemistry.

The section of this book dealing with natural products has presented many difficulties. I have tried to give a general indication of the problems involved, and in doing so I have chosen, to a large extent, the most typical compounds for fairly detailed discussion. At the same time, I believe that the subject matter covered should serve as a good introduction to the organic chemistry required by students reading for Part II of the Special Honours degree in chemistry of the London University. I have given a selected number of reading references at the end of each chapter to enable students to extend their knowledge and also to make up for any omissions I may have made. It is impossible to express my indebtedness to those authors of monographs, articles, etc., from which I have gained so much information, and I can only hope that some measure of my gratitude is expressed by the references I have given to their works.

Since physical measurements are now very much used in elucidating structures of organic compounds, I have included a short chapter on these measurements (Chapter I). I have introduced only a minimum amount of theory in this chapter to enable the student to understand the terms used; the main object is to indicate the *applications* of physical measurements.

In this book, cross-references are indicated by section and chapter. If a cross-reference occurs to another section in that chapter, then only the section number is given. It should also be noted that the numbers assigned to formulæ, etc., are confined to each section, and not carried on to subsequent sections in that chapter. When references have been given to my earlier volume, the latter has been referred to as Volume I. In such cases the pages have not been quoted since the pagination of the various editions changes. The student, however, should have no difficulty in locating the reference from the index of Volume I.

I. L. FINAR

1955

# CONTENTS

LIST OF JOURNAL ABBREVIATIONS . . . . .	PAGE xii
---	-------------

CHAPTER

I. PHYSICAL PROPERTIES AND CHEMICAL CONSTITUTION . . . . .	1
Introduction, 1. Van der Waals forces, 1. The hydrogen bond, 2. Melting point, 3. Boiling point, 4. Solubility, 4. Viscosity, 5. Molecular volumes, 5. Parachor, 6. Refractor, 7. Refractive index, 7. Molecular rotation, 8. Rotatory dispersion, 10. Dipole moments, 11. Magnetic susceptibility, 12. Absorption spectra, 13. X-ray analysis, 16. Electron diffraction, 17. Neutron crystallography, 17. Electron spin resonance, 17. Nuclear magnetic resonance, 17.	
II. OPTICAL ISOMERISM . . . . .	20
Stereoisomerism: definitions, 20. Optical isomerism, 20. The tetrahedral carbon atom, 21. Conformational analysis, 28. Conventions used in stereochemistry, 30. Correlation of configurations, 34. Specification of asymmetric configurations, 35. Elements of symmetry, 37. Number of isomers in optically active compounds, 40. The racemic modification, 45. Properties of the racemic modification, 48. Methods for determining the nature of the racemic modification, 49. Quasi-racemate method, 50. Resolution of racemic modifications, 51. The cause of optical activity, 56.	
III. NUCLEOPHILIC SUBSTITUTION AT A SATURATED CARBON ATOM . . . . .	60
$S_N1$ and $S_N2$ mechanisms, 60. FACTORS AFFECTING MECHANISM: Polar effects, 61. Steric effects, 63. Nature of the halogen atom, 65. Nature of reagent, 66. Nature of solvent, 67. WALDEN INVERSION, 69. Mechanism of Walden inversion, 71. $S_Ni$ mechanism, 73. Participation of neighbouring groups, 74. ASYMMETRIC SYNTHESIS: Partial asymmetric synthesis, 79. Conformational analysis, 82. Absolute asymmetric synthesis, 85.	
IV. GEOMETRICAL ISOMERISM . . . . .	87
Nature of geometrical isomerism, 87. Rotation about a double bond, 88. Modern theory of the nature of double bonds, 88. Nomenclature of geometrical isomers, 89. Determination of configuration of geometrical isomers, 91. Stereochemistry of addition reactions, 98. Stereochemistry of elimination reactions, 100. STEREOCHEMISTRY OF CYCLIC COMPOUNDS: <i>cyclo</i> Propane types, 105. <i>cyclo</i> Butane types, 107. <i>cyclo</i> Pentane types, 108. <i>cyclo</i> Hexane types; conformational analysis, 109. Fused ring systems; conformational analysis, 116.	
V. STEREOCHEMISTRY OF DIPHENYL COMPOUNDS . . . . .	126
Configuration of the diphenyl molecule, 126. Optical activity of the diphenyl compounds, 127. Absolute configurations of diphenyls, 130. Other examples of restricted rotation, 130. Molecular overcrowding, 133. Racemisation of diphenyl compounds, 135. Evidence for the obstacle theory, 138. STEREOCHEMISTRY OF THE ALLENES, 139. STEREOCHEMISTRY OF THE SPIRANS, 140.	

CHAPTER		PAGE
VI.	STEREOCHEMISTRY OF SOME ELEMENTS OTHER THAN CARBON . . . . .	143
	Shapes of molecules, 143. Nitrogen compounds, 143. Phosphorus compounds, 161. Arsenic compounds, 163. Antimony compounds, 169. Sulphur compounds, 169. Silicon compounds, 174. Tin compounds, 174. Germanium compounds, 174. Selenium compounds, 174. Tellurium compounds, 175.	
VII.	CARBOHYDRATES . . . . .	176
	Determination of the configuration of the monosaccharides, 176. Ring structure of the monosaccharides, 181. Methods for determining the size of sugar rings, 187. Conformational analysis, 201. <i>iso</i> Propylidene derivatives of the monosaccharides, 203. Vitamin C, 208. Disaccharides, 214. Trisaccharides, 223. Polysaccharides, 224. Photosynthesis, 232. Glycosides, 234.	
VIII.	TERPENES . . . . .	242
	Isoprene rule, 242. Isolation of terpenes, 244. General methods for determining structure, 244. Monoterpenes: Acyclic monoterpenes, 245. Monocyclic monoterpenes, 255. Bicyclic monoterpenes, 271. Correlation of configuration, 292. Sesquiterpenes: Acyclic sesquiterpenes, 295. Monocyclic sesquiterpenes, 297. Bicyclic sesquiterpenes, 299. DITERPENES, 308. TRITERPENES, 313. Biosynthesis of terpenes, 314. POLYTERPENES: Rubber, 317.	
IX.	CAROTENOIDS . . . . .	321
	Introduction, 321. Carotenes, 321. Vitamin A, 330. Xanthophylls, 335. Carotenoid acids, 336.	
X.	POLYCYCLIC AROMATIC HYDROCARBONS . . . . .	339
	Introduction, 339. General methods of preparation, 339. Benzanthracenes, 347. Phenanthrene derivatives, 351.	
XI.	STEROIDS . . . . .	358
	Introduction, 358. Sterols: Cholesterol, 359. Stereochemistry of the steroids, 376. Conformational analysis, 380. Ergosterol, 382. Vitamin D group, 384. Stigmasterol, 387. Biosynthesis of sterols, 389. BILE ACIDS, 390. SEX HORMONES: Androgens, 395. Oestrogens, 398. Gestagens, 409. ADRENAL CORTICAL HORMONES, 415. AUXINS, 418.	
XII.	HETEROCYCLIC COMPOUNDS CONTAINING TWO OR MORE HETERO-ATOMS . . . . .	421
	Nomenclature, 421. AZOLES: Pyrazoles, 421. Imidazoles, 428. Oxazoles, 430. Thiazoles, 431. Triazoles, 433. Sydnone, 434. Tetrazoles, 436. AZINES: Pyridazines, 437. Pyrimidines, 438. Pyrazines, 444. Benzodiazines, 445. Oxazines, 446. Phenoxazines, 446. Thiazines, 447. Triazines and Tetrazines, 447.	
XIII.	AMINO-ACIDS AND PROTEINS . . . . .	449
	Classification of amino-acids, 449. General methods of preparation, 449. Isolation of amino-acids, 457. General properties of amino-acids, 458. THYROXINE, 462. PROTEINS: General nature of proteins, 465. Structure of proteins, 468. Polypeptides, 471. ENZYMES: Nomenclature, 477. Classification, 477. Conditions for enzyme action, 478. Biosynthesis of amino-acids and proteins, 480.	
XIV.	ALKALOIDS . . . . .	484
	Introduction, 484. Extraction of alkaloids, 484. General methods for determining structure, 485. Classification, 488. Phenylethylamine group, 489. Pyrrolidine group, 495. Pyridine group, 497. Pyrrolidine-Pyridine group, 504. Quinoline group, 520. <i>iso</i> Quinoline group, 533. Phenanthrene group, 537. Biosynthesis of alkaloids, 541.	



CHAPTER	PAGE
<b>XV. ANTHOCYANINS</b> . . . . .	<b>545</b>
Introduction, 545. General nature of anthocyanins, 545. Structure of the anthocyanidins, 546. FLAVONES, 557. <i>iso</i> FLAVONES, 565. Biosynthesis of flavonoids, 566. DEPSIDES, 566.	
<b>XVI. PURINES AND NUCLEIC ACIDS</b> . . . . .	<b>569</b>
Introduction, 569. Uric acid, 569. Purine derivatives, 576. Xanthine bases, 580. Biosynthesis of purines, 586. NUCLEIC ACIDS, 587.	
<b>XVII. VITAMINS</b> . . . . .	<b>598</b>
Introduction, 598. Vitamin B complex, 598. Vitamin E group, 619. Vitamin K group, 623.	
<b>XVIII. CHEMOTHERAPY</b> . . . . .	<b>627</b>
Introduction, 627. Sulphonamides, 627. Antimalarials, 630. Arsenical drugs, 631. ANTIBIOTICS: The Penicillins, 632. Streptomycin, 637. Aureomycin and Terramycin, 638. Patulin, 639. Chloramphenicol, 640.	
<b>XIX. HÆMOGLOBIN, CHLOROPHYLL AND PHTHALOCYANINES</b> . . . . .	<b>643</b>
Introduction, 643. Hæmoglobin, 643. Biosynthesis of porphyrin, 654. Chlorophyll, 656. Phthalocyanines, 662.	
<b>AUTHOR INDEX</b> . . . . .	<b>667</b>
<b>SUBJECT INDEX</b> . . . . .	<b>674</b>

## LIST OF JOURNAL ABBREVIATIONS

ABBREVIATIONS	JOURNALS
<i>Ann. Reports (Chem. Soc.)</i>	Annual Reports of the Progress of Chemistry (The Chemical Society, London).
<i>Ber.</i>	Berichte der deutschen chemischen Gesellschaft (name now changed to <i>Chemische Berichte</i> ).
<i>Bull. Soc. chim.</i>	Bulletin de la Société chimique de France.
<i>Chem. Reviews</i>	Chemical Reviews.
<i>Chem. and Ind.</i>	Chemistry and Industry.
<i>Experientia</i>	Experientia.
<i>Ind. chim. belg.</i>	Industrie chimique belge.
<i>Ind. Eng. Chem.</i>	Industrial and Engineering Chemistry.
<i>J. Amer. Chem. Soc.</i>	Journal of the American Chemical Society.
<i>J. Chem. Educ.</i>	Journal of Chemical Education.
<i>J.C.S.</i>	Journal of the Chemical Society.
<i>J. Pharm. Pharmacol.</i>	Journal of Pharmacy and Pharmacology.
<i>J. Roy. Inst. Chem.</i>	Journal of the Royal Institute of Chemistry.
<i>Nature</i>	Nature.
<i>Proc. Chem. Soc.</i>	Proceedings of the Chemical Society.
<i>Quart. Reviews (Chem. Soc.)</i>	Quarterly Reviews of the Chemical Society (London)
<i>Science</i>	Science.
<i>Tetrahedron</i>	Tetrahedron.

## PHYSICAL PROPERTIES AND CHEMICAL CONSTITUTION

**§1. Introduction.** A tremendous amount of work has been and is being done to elucidate the relationships between physical properties and chemical structure. An ideal state to be achieved is one where the chemist can predict with great accuracy the physical properties of an organic compound whose structure is known, or formulate the correct structure of an organic compound from a detailed knowledge of its physical properties. A great deal of progress has been made in this direction as is readily perceived by examining the methods of elucidating structures of organic compounds over the last few decades. In the early work, the structure of an organic compound was solved by purely chemical means. These are, briefly:

- (i) Qualitative analysis.
- (ii) Quantitative analysis, which leads to the empirical formula.
- (iii) Determination of the molecular weight, which leads to the molecular formula.
- (iv) If the molecule is relatively simple, the various possible structures are written down (based on the valency of carbon being four, that of hydrogen one, oxygen two, etc.). Then the reactions of the compound are studied, and the structure which best fits the facts is chosen. In those cases where the molecules are not relatively simple, the compounds are examined by specific tests to ascertain the nature of the various groups present (see, *e.g.*, alkaloids, §4. XIV). The compounds are also degraded and the smaller fragments examined. By this means it is possible to suggest a tentative structure.
- (v) The final stage for elucidation of structure is synthesis, and in general, the larger the number of syntheses of a compound by *different* routes, the more reliable will be the structure assigned to that compound.

In recent years, chemists are making increasing use of physical properties, in addition to purely chemical methods, to ascertain the structures of new compounds. Furthermore, information on structure has been obtained from physical measurements where such information could not have been obtained by chemical methods. The early chemists identified pure compounds by physical characteristics such as boiling point, melting point, refractive index; nowadays many other physical properties are also used to characterise pure compounds.

The following account describes a number of relationships between physical properties and chemical constitution, and their application to the problem of elucidating chemical structure.

**§2. Van der Waals forces.** Ostwald (1910) classified physical properties as **additive** (these properties depend only on the nature and number of atoms in a molecule), **constitutive** (these properties depend on the nature, number and arrangement of the atoms in the molecule), and **colligative** (these properties depend only on the number of molecules present, and are independent of their chemical constitution). It is extremely doubtful whether any one of these three classes of properties is absolutely independent of either or both of the others, except for the case of molecular weights, which may be regarded as truly additive and independent of the other two.

In constitutive and colligative properties, forces between molecules have a very great effect on these properties. Attractive forces between molecules of a substance must be assumed in order to explain cohesion in liquids and solids. Ideal gases obey the equation  $PV = RT$ , but real gases do not, partly because of the attractive forces between molecules. Van der Waals (1873) was the first to attempt to modify the ideal gas law for the behaviour of real gases by allowing for these attractive forces (he introduced the term  $a/v^2$  to correct for them). These intermolecular forces are now usually referred to as *van der Waals forces*, but they are also known as *residual* or *secondary valencies*. These forces may be forces of attraction or forces of repulsion; the former explain cohesion, and the latter must be assumed to exist at short distances, otherwise molecules would collapse into one another when intermolecular distances become very small. The distances to which atoms held together by van der Waals forces can approach each other, *i.e.*, the distances at which the repulsion becomes very large, are known as *van der Waals radii*. Some values (in Angstroms) are:

H, 1.20; O, 1.40; N, 1.50; Cl, 1.80; S, 1.85.

These values are very useful in connection with molecules that exhibit the steric effect, *e.g.*, substituted diphenyl compounds (§2. V).

Van der Waals forces are electrostatic in nature. They are relatively weak forces (*i.e.*, in comparison with *bond* forces), but they are greater for compounds than for atoms and molecules of elements. In fact, the more asymmetrical the molecule, the greater are the van der Waals forces. These forces originate from three different causes:

(i) Forces due to the interaction between the permanent dipole moments of the molecules (Keesom, 1916, 1921). These forces are known as **Keesom forces** or the **dipole-dipole effect**, and are dependent on temperature.

(ii) Forces which result from the interaction of a *permanent* dipole and *induced* dipoles. Although a molecule may not possess a permanent dipole, nevertheless a dipole may be induced under the influence of neighbouring molecules which do possess a permanent dipole (Debye, 1920, 1921). These forces are known as **Debye forces**, the **dipole-induced dipole effect** or **induction effect**, and are almost independent of temperature.

(iii) London (1930) showed from wave mechanics that a third form of van der Waals forces is also acting. A nucleus and its "electron cloud" are in a state of vibration, and when two atoms are sufficiently close to each other, the two nuclei and the two electron clouds tend to vibrate together, thereby leading to attraction between different molecules. These forces are known as **London forces**, **dispersion forces**, or the **wave-mechanical effect**, and are independent of temperature.

It should be noted that the induced forces are smaller than the other two, and that the dispersion forces are usually the greatest.

It can now be seen that all those physical properties which depend on intermolecular forces, *e.g.*, melting point, boiling point, viscosity, etc., will thus be largely determined by the van der Waals forces. Van der Waals forces may also be responsible for the formation of molecular complexes (see Vol. I).

**§3. The hydrogen bond.** A particularly important case of electrostatic attraction is that which occurs in *hydrogen bonding* (Vol. I, Ch. II); it occurs mainly in compounds containing hydroxyl or imino groups. There are two types of hydrogen bonding, *intermolecular* and *intramolecular*. Intermolecular bonding gives rise to association, thereby raising the boiling point; it also raises the surface tension and the viscosity, but lowers the dielectric constant. Intermolecular hydrogen bonding may exist in compounds in the liquid or solid state, and its formation is very much affected by the shape of

the molecules, *i.e.*, by the *spatial* or *steric* factor; *e.g.*, *n*-pentanol is completely associated, whereas *tert*-pentanol is only partially associated. Intermolecular hydrogen bonding is also responsible for the formation of various molecular compounds, and also affects solubility if the compound can form hydrogen bonds with the solvent.

Intramolecular hydrogen bonding gives rise to *chelation*, *i.e.*, ring formation, and this normally occurs only with the formation of 5-, 6-, or 7-membered rings. Chelation has been used to explain the volatility of *ortho*-compounds such as *o*-halogenophenols and *o*-nitrophenols (as compared with the corresponding *m*- and *p*-derivatives). Chelation has also been used to account for various *ortho*-substituted benzoic acids being stronger acids than the corresponding *m*- and *p*-derivatives (see Vol. I, Ch. XXVIII).

When chelation occurs, the ring formed must be planar or almost planar. Should another group be present which prevents the formation of a *planar* chelate structure, then chelation will be diminished or even completely inhibited (Hunter *et al.*, 1938; *cf.* steric inhibition of resonance, Vol. I, Ch. XXVIII). Compound I is chelated, but II is associated and not chelated. In I the *o*-nitro-group can enter into the formation of a *planar* six-membered

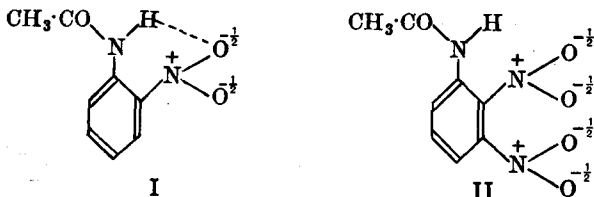

ring. In II, owing to the strong repulsion between the negatively charged oxygen atoms of the two nitro-groups, the plane of each nitro-group will tend to be perpendicular to the plane of the benzene ring, and consequently a chelated *planar* six-membered ring cannot be formed.

The presence of hydrogen bonding may be detected by various means, *e.g.*, infra-red absorption spectra, X-ray analysis, electron diffraction, examination of boiling points, melting points, solubility, etc. The best method appears to be that of infra-red absorption spectra (see §15b).

**§4. Melting point.** In most solids the atoms or molecules are in a state of vibration about their fixed mean positions. These vibrations are due to the thermal energy and their amplitudes are small compared with interatomic distances. As the temperature of the solid is raised, the amplitude of vibration increases and a point is reached when the crystalline structure suddenly becomes unstable; this is the melting point.

In many homologous series the melting points of the *n*-members rise continuously, tending towards a maximum value. On the other hand, some homologous series show an alternation or oscillation of melting points—"the saw-tooth rule", *e.g.*, in the fatty acid series the melting point of an "even" acid is higher than that of the "odd" acid immediately below and above it. It has been shown by X-ray analysis that this alternation of melting points depends on the packing of the crystals. The shape of the molecule is closely related to the melting point; the more symmetrical the molecule, the higher is the melting point. Thus with isomers, branching of the chain (which increases symmetry) usually raises the melting point; also *trans*-isomers usually have a higher melting point than the *cis*-, the former having greater symmetry than the latter (see §5. IV). In the benzene series, of the three disubstituted derivatives, the *p*-compound usually has the highest melting point.

Apart from the usual van der Waals forces which affect melting points

hydrogen bonding may also play a part, *e.g.*, the melting point of an alcohol is higher than that of its corresponding alkane. This may be attributed to hydrogen bonding, which is possible in the former but not in the latter.

Various *empirical* formulæ have been developed from which it is possible to calculate melting points; these formulæ, however, only relate members of an *homologous* series.

The method of mixed melting points has long been used to identify a compound, and is based on the principle that two different compounds mutually lower the melting point of each component in the mixture. This method, however, is unreliable when the two compounds form a solid solution.

**§5. Boiling point.** The boiling point of a liquid is that temperature at which the vapour pressure is equal to that of the external pressure. Thus the boiling point varies with the pressure, being raised as the pressure is increased.

In an homologous series, the boiling point usually increases regularly for the *n*-members, *e.g.*, Kopp (1842) found that with the aliphatic alcohols, acids, esters, etc., the boiling point is raised by 19° for each increase of CH<sub>2</sub> in the composition. In the case of isomers the greater the branching of the carbon chain, the lower is the boiling point. Calculation has shown that the boiling point of the *n*-alkanes should be proportional to the number of carbon atoms in the molecule. This relationship, however, is not observed in practice, and the cause of this deviation still remains to be elucidated. One strongly favoured theory attributes the cause to the fact that the carbon chains of *n*-alkanes in the liquid phase exist largely in a coiled configuration. As the branching increases, the coil becomes denser, and this lowers the boiling point.

In aromatic disubstituted compounds the boiling point of the *ortho*-isomer is greater than that of the *meta*-isomer which, in turn, may have a higher boiling point than the *para*-isomer, but in many cases the boiling points are about the same.

Since the boiling point depends on the van der Waals forces, any structural change which affects these forces will consequently change the boiling point. One such structural change is the branching of the carbon chain (see above). Another type of change is that of substituting hydrogen by a negative group. This introduces a dipole moment (or increases the value of an existing dipole moment), thereby increasing the attractive forces between the molecules and consequently raising the boiling point, *e.g.*, the boiling points of the nitro-alkanes are very much higher than those of the corresponding alkanes. The possibility of intermolecular hydrogen bonding also raises the boiling point, *e.g.*, alcohols boil at higher temperatures than the corresponding alkanes.

**§6. Solubility.** It is believed that solubility depends on the following intermolecular forces: solvent/solute; solute/solute; solvent/solvent. The solubility of a non-electrolyte in water depends, to a very large extent, on whether the compound can form hydrogen bonds with the water, *e.g.*, the alkanes are insoluble, or almost insoluble, in water. Methane, however, is more soluble than any of its homologues. The reason for this is uncertain; hydrogen bonding with water is unlikely, and so other factors must play a part, *e.g.*, molecular size. A useful guide in organic chemistry is that "like dissolves like", *e.g.*, if a compound contains a hydroxyl group, then the best solvents for that compound also usually contain hydroxyl groups (hydrogen bonding between solvent and solute is possible). This "rule" is accepted by many who use the word "like" to mean that the cohesion forces in both solvent and solute arise from the same source, *e.g.*, alkanes

and alkyl halides are miscible; the cohesion forces of both of these groups of compounds are largely due to dispersion forces.

In some cases solubility may be due, at least partly, to the formation of a compound between the solute and the solvent, *e.g.*, ether dissolves in concentrated sulphuric acid with the formation of an oxonium salt,  $(C_2H_5)_2OH^+HSO_4^-$ .

**§7. Viscosity.** Viscosity (the resistance to flow due to the internal friction in a liquid) depends, among other factors, on the van der Waals forces acting between the molecules. Since these forces depend on the shape and size of the molecules, the viscosity will also depend on these properties. At the same time, since the Keesom forces (§2) depend on temperature, viscosity will also depend on temperature; other factors, however, also play a part.

A number of relationships have been found between the viscosity of pure liquids and their chemical structure, *e.g.*,

(i) In an homologous series, viscosity increases with the molecular weight.

(ii) With isomers the viscosity of the *n*-compound is greater than that of isomers with branched carbon chains.

(iii) Abnormal viscosities are shown by *associated* liquids. Viscosity measurements have thus been used to determine the degree of association in liquids.

(iv) The viscosity of a *trans*-compound is greater than that of the corresponding *cis*-isomer.

Equations have been developed relating viscosity to the shape and size of *large* molecules (*macromolecules*) in solution, and so viscosity measurements have offered a means of determining the shape of, *e.g.*, proteins, and the molecular weight of, *e.g.*, polysaccharides.

**§8. Molecular volumes.** The molecular volume of a liquid in millilitres ( $V_m$ ) is given by the equation

$$V_m = \frac{\text{gram molecular weight}}{\text{density}}$$

The relation between molecular volume and chemical composition was studied by Kopp (1839–1855). Since the density of a liquid varies with the temperature, it was necessary to choose a standard temperature for comparison. Kopp chose the boiling point of the liquid as the standard temperature. This choice was accidental, but proved to be a fortunate one since the absolute boiling point of a liquid at atmospheric pressure is approximately two-thirds of the critical temperature, *i.e.*, Kopp unknowingly compared liquids in their corresponding states, the theory of which did not appear until 1879. As a result of his work, Kopp was able to compile a table of atomic volumes based on the assumption that the molecular volume was an additive property, *e.g.*,

C	11.0	Cl	22.8
H	5.5	Br	27.8
O (C=O)	12.2	I	37.5
O(OH)	7.8		

It should be noted that Kopp found that the atomic volume of oxygen (and sulphur) depended on its state of combination. Kopp also showed that the molecular volume of a compound can be calculated from the sum of the atomic volumes, *e.g.*, acetone,  $CH_3 \cdot CO \cdot CH_3$ .

$$\begin{array}{rcl}
 3C & = & 33.0 \\
 6H & = & 33.0 \\
 O(CO) & = & 12.2 \\
 \hline
 & & 78.2 \text{ (calc.)}
 \end{array}
 \quad
 \begin{array}{rcl}
 \text{Molecular weight of acetone} & = & 58 \\
 \text{Density at b.p.} & = & 0.749 \\
 \therefore \text{molecular volume (obs.)} & = & \frac{58}{0.749} = 77.4
 \end{array}$$

Further work has shown that the molecular volume is not strictly additive, but also partly constitutive (as recognised by Kopp who, however, tended to overlook this feature). If purely additive, then isomers with *similar* structures will have the same molecular volume. This has been found to be the case for, *e.g.*, isomeric esters, but when the isomers belong to different homologous series, the agreement may be poor.

Later tables have been compiled for atomic volumes with structural corrections. Even so, the relation breaks down in the case of highly polar liquids where the attractive forces between the molecules are so great that the additive (and structural) properties of the atomic volumes are completely masked.

§9. **Parachor.** Macleod (1923) introduced the following equation:

$$\gamma = C(d_l - d_g)^4$$

where  $\gamma$  is the surface tension,  $d_l$  and  $d_g$  the densities of the liquid and vapour respectively, and C is a constant which is independent of the temperature.

Macleod's equation can be rewritten as:

$$\frac{\gamma^{\frac{1}{4}}}{d_l - d_g} = C^{\frac{1}{4}}$$

Sugden (1924) multiplied both sides of this equation by the molecular weight, M, and pointed out that the expression

$$\frac{M\gamma^{\frac{1}{4}}}{d_l - d_g} = MC^{\frac{1}{4}} = [P]$$

should also be valid. Sugden called the constant P for a given compound the *parachor* of that compound. Provided the temperature is not too high,  $d_g$  will be negligible compared with  $d_l$ , and so we have

$$[P] = \frac{M\gamma^{\frac{1}{4}}}{d_l}$$

Hence the parachor represents the molecular volume of a liquid at the temperature when its surface tension is unity. Thus a comparison of parachors of different liquids gives a comparison of molecular volumes at temperatures at which liquids have the same surface tension. By this means allowance is made for the van der Waals forces, and consequently the comparison of molecular volumes is carried out under comparable conditions.

The parachor is largely an additive property, but it is also partly constitutive. The following table of atomic and structural parachors is that given by Mumford and Phillips (1929).

C	9.2	Single bond	0
H	15.4	Co-ordinate bond	0
O	20	Double bond	19
N	17.5	Triple bond	38
Cl	55	3-Membered ring	12.5
Br	69	4- " "	6
I	90	5- " "	3
S	50	6- " "	0.8
		7- " "	- 4

The parachor has been used to enable a choice to be made between alternative structures, *e.g.*, structures I and II had been suggested for *p*-benzoquinone. Most of the chemical evidence favoured I, but Graebe



(1867) proposed II to explain some of the properties of this compound (see Vol. I). The parachor has been used to decide between these two:

[P] calculated for I is 233·6;

$$[6 \times 9.2 + 4 \times 15.4 + 2 \times 20 + 4 \times 19 + 0.8]$$

[P] calculated for II is 215·4;

$$[6 \times 9.2 + 4 \times 15.4 + 2 \times 20 + 3 \times 19 + 2 \times 0.8]$$

[P] observed is 236·8. This indicates structure I.

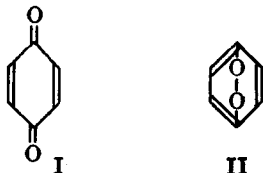

According to Sutton (1952), the parachor is not a satisfactory property for the analysis of molecular structure. It is, however, still useful as a physical characteristic of the liquid-vapour system.

**§10. Refractor.** Joshi and Tuli (1951) have introduced a new physical constant which they have named the *refractor*, [F]. This has been obtained by associating the parachor, [P], with the refractive index, ( $n_D^{20}$ ), according to the following equation:

$$[F] = -[P] \log (n_D^{20} - 1)$$

The authors have found that the observed refractor of any compound is composed of two constants, one dependent on the nature of the atoms, and the other on structural factors, *e.g.*, type of bond, size of ring, etc., *i.e.*, the refractor is partly additive and partly constitutive. Joshi and Tuli have used the refractor to determine the percentage of tautomers in equilibrium mixtures, *e.g.*, they found that ethyl acetoacetate contains 7·7 per cent. enol, and penta-2 : 4-dione 72·4 per cent. enol.

**§11. Refractive index.** Lorentz and Lorenz (1880) simultaneously showed that

$$R = \frac{n^2 - 1}{n^2 - 2} \frac{M}{d}$$

where R is the *molecular refractivity*,  $n$  the refractive index, M the molecular weight, and  $d$  the density. The value of  $n$  depends on the wavelength and on temperature;  $d$  depends on temperature.

Molecular refractivity has been shown to have both additive and constitutive properties. The following table of atomic and structural refractivities has been calculated for the  $H_\alpha$  line.

C	2·413	Cl	5·933
H	1·092	Br	8·803
O(OH)	1·522	I	13·757
O(CO)	2·189	Double bond (C=C)	1·686
O(ethers)	1·639	Triple bond (C≡C)	2·328

Molecular refractivities have been used to determine the structure of compounds, *e.g.*, terpenes (see §25. VIII). They have also been used to detect the presence of tautomers and to calculate the amount of each form present. Let us consider ethyl acetoacetate as an example; this behaves as the keto form  $\text{CH}_3 \cdot \text{CO} \cdot \text{CH}_2 \cdot \text{CO}_2 \text{C}_2\text{H}_5$ , and as the enol form  $\text{CH}_3 \cdot \text{C}(\text{OH})=\text{CH} \cdot \text{CO}_2 \text{C}_2\text{H}_5$ .

The calculated molecular refractivities of these forms are:

$\text{CH}_3 \cdot \text{CO} \cdot \text{CH}_2 \cdot \text{CO}_2 \text{C}_2\text{H}_5$	$\text{CH}_3 \cdot \text{C}(\text{OH}) = \text{CH} \cdot \text{CO}_2 \text{C}_2\text{H}_5$
6 C = 14.478	6 C = 14.478
10 H = 10.92	10 H = 10.92
2 O (CO) = 4.378	O (OH) = 1.522
O (ether) = 1.639	O (CO) = 2.189
<u>31.415</u>	O (ether) = 1.639
	Double bond = 1.686
	<u>32.434</u>

The observed molecular refractivity of ethyl acetoacetate is 31.89; hence both forms are present.

When a compound contains two or more double bonds, the value of the molecular refractivity depends not only on their number but also on their relative positions. When the double bonds are *conjugated*, then anomalous results are obtained, the observed molecular refractivity being higher than that calculated, e.g., the observed value for hexa-1 : 3 : 5-triene is 2.06 units greater than the value calculated. This anomaly is known as *optical exaltation*, and it usually increases with increase in length of conjugation (in unsubstituted chains). Although optical exaltation is characteristic of acyclic compounds, it is also exhibited by cyclic compounds. In single-ring systems, e.g., benzene, pyridine, pyrrole, etc., the optical exaltation is negligible; this has been attributed to resonance. In polycyclic aromatic compounds, however, the exaltation may have a large value. In general, large exaltations are shown by those compounds which exhibit large *electronic* effects.

Another application of the refractive index is its relation to hydrogen bonding. Arshid *et al.* (1955, 1956) have used the square of the refractive index to detect hydrogen-bond complexes.

**§12. Molecular rotation.** When a substance possesses the property of rotating the plane of polarisation of a beam of plane-polarised light passing through it, that substance is said to be **optically active**. The measurement of the **rotatory power** of a substance is carried out by means of a polarimeter. If the substance rotates the plane of polarisation to the right, *i.e.*, the analyser has to be turned to the right (clockwise) to restore the original field, the substance is said to be *dextrorotatory*; if to the left (anti-clockwise), *levorotatory*.

It has been found that the amount of the rotation depends, for a given substance, on a number of factors:

(i) *The thickness of the layer traversed.* The amount of the rotation is directly proportional to the length of the active substance traversed (Biot, 1835).

(ii) *The wavelength of the light.* The rotatory power is approximately inversely proportional to the square of the wavelength (Biot, 1835). There are some exceptions, and in certain cases it has been found that the rotation changes sign. This change in rotatory power with change in wavelength is known as *rotatory dispersion*. Hence it is necessary (for comparison of rotatory power) to use monochromatic light; the sodium D line (yellow: 5893 Å) is one wavelength that is commonly used (see also §12a).

(iii) *The temperature.* The rotatory power usually increases with rise in temperature, but many cases are known where the rotatory power decreases. Hence, for comparison, it is necessary to state the temperature; in practice, measurements are usually carried out at 20 or 25°.

(iv) *The solvent.* The nature of the solvent affects the rotation, and so it is necessary to state the solvent used in the measurement of the rotatory

power. There appears to be some relation between the effect of a solvent on rotatory power and its dipole moment.

(v) *The concentration.* The rotation appears to be independent of the concentration provided that the solution is dilute. In concentrated solutions, however, the rotation varies with the concentration; the causes for this have been attributed to association, dissociation, or solvation (see also vi).

(vi) The amount of rotation exhibited by a given substance when all the preceding factors (i-v) have been fixed may be varied by the presence of other compounds which are not, in themselves, optically active, *e.g.*, inorganic salts. It is important to note in this connection that optically active acids or bases, in the form of their salts, give rotations which are independent of the nature of the non-optically active ion *provided that the solutions are very dilute*. In very dilute solutions, salts are completely dissociated, and it is only the optically active ion which then contributes to the rotation. The rotation of a salt formed from an optically active acid and an optically active base reaches a constant value in dilute solutions, and the rotation is the sum of the rotations of the anion and cation. This property has been used to detect optical activity (see §5a. VI).

When recording the rotations of substances, the value commonly given is the **specific rotation**,  $[\alpha]_{\lambda}^t$ . This is obtained from the equation:

$$[\alpha]_{\lambda}^t = \frac{\alpha_{\lambda}^t}{l \times d} \quad \text{or} \quad [\alpha]_{\lambda}^t = \frac{\alpha_{\lambda}}{l \times c}$$

where  $l$  is the thickness of the layer in decimetres,  $d$  the density of the liquid (if it is a pure compound),  $c$  the number of grams of substance per millilitre of solution (if a solution is being examined),  $\alpha$  the *observed* rotation,  $t$  the temperature and  $\lambda$  the wavelength of the light used. The solvent should also be stated (see iv).

The **molecular rotation**,  $[M]_{\lambda}^t$ , is obtained by multiplying the specific rotation by the molecular weight,  $M$ . Since large numbers are usually obtained, a common practice is to divide the result by one hundred; thus:

$$[M]_{\lambda}^t = \frac{[\alpha]_{\lambda}^t \times M}{100}$$

The relation between structure and optical activity is discussed later (see §§2, 3. II). The property of optical activity has been used in the study of the configuration of molecules and mechanisms of various reactions, and also to decide between alternative structures for a given compound. The use of optical rotations in the determination of structure depends largely on the application of two rules.

(i) **Rule of Optical Superposition** (van't Hoff, 1894): When a compound contains two or more asymmetric centres, the total rotatory power of the molecules is the algebraic sum of the contributions of each asymmetric centre. This rule is based on the assumption that the contribution of each asymmetric centre is independent of the other asymmetric centres present. It has been found, however, that the contribution of a given asymmetric centre is affected by neighbouring centres and also by the presence of chain-branching and unsaturation. Hence the rule, although useful, must be treated with reserve (see also §6. VII).

A more satisfactory rule is the **Rule of Shift** (Freudenberg, 1933): If two asymmetric molecules A and B are changed in the same way to give A' and B', then the differences in molecular rotation (A' - A) and (B' - B) are of the same sign (see, *e.g.*, §4b. XI).

(ii) **Distance Rule** (Tschugaev, 1898): The effect of a given structural change on the contribution of an asymmetric centre decreases the further the centre of change is from the asymmetric centre.

Only asymmetric molecules have the power, under normal conditions, to rotate the plane of polarisation (of plane-polarised light). Faraday (1845), however, found that any transparent substance can rotate the plane of polarisation when placed in a strong magnetic field. This property of **magnetic optical rotation** (**Faraday effect**) is mainly an additive one, but is also partly constitutive.

**§12a. Rotatory dispersion.** In §12 we have discussed the method of optical rotations using *monochromatic rotations*. There is also, however, the method of *rotatory dispersion*. Optical rotatory dispersion is the change in rotatory power with change in wavelength, and rotatory dispersion measurements are valuable only for asymmetric compounds. In order to study the essential parts of dispersion curves, it is necessary to measure the optical rotation of a substance right through an absorption band of that substance. This is experimentally possible only if this absorption band is in an accessible part of the spectrum. Up to the present, the carbonyl group ( $\lambda_{\max}$  at 280–300  $m\mu$ ) is the only convenient absorbing group that fulfils the necessary requirements. Thus, at the moment, measurements are taken in the range 700 to 270  $m\mu$ .

There are three types of rotatory dispersion curves: (a) Plain curves; (b) single Cotton Effect curves; (c) multiple Cotton Effect curves. We shall describe (a) and (b); (c) shows two or more peaks and a corresponding number of troughs.

*Plain curves.* These show no maximum or minimum, *i.e.*, they are *smooth curves*, and may be positive or negative according as the rotation becomes more positive or negative as the wavelength changes from longer to shorter values (Fig. 1a).

*Single Cotton Effect curves.* These are also known as *anomalous curves* and show a maximum and a minimum, both of these occurring in the region

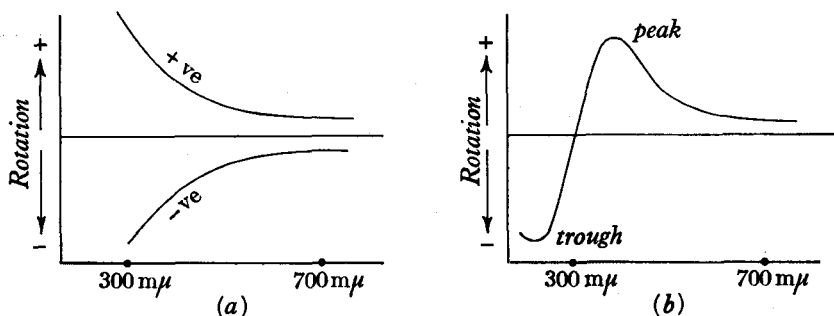

FIG. 1.1.

of maximum absorption (Fig. 1 b). The curves are said to be positive or negative according as the peak or trough occurs in the longer wavelength. Thus the curve shown in Fig. 1 (b) is positive.

As pointed out above, to obtain single Cotton Effect curves (see also §8. III) the molecule must contain a carbonyl group. The wavelength of maximum ultraviolet absorption is referred to as "the optically active absorption band", and since rotatory dispersion measurements are of value only for asymmetric compounds, to obtain suitable curves compounds containing a carbonyl group in an asymmetric environment must be used. Enantiomorphs have curves which are mirror images of each other; compounds

which are enantiomorphic in the neighbourhood of the carbonyl group have dispersion curves which are approximately mirror images of each other; and compounds which have the same relative configurations in the neighbourhood of the carbonyl group have dispersion curves of the same sign.

There are many applications of rotatory dispersion: (i) quantitative analytical uses; (ii) identification of the carbonyl group; (iii) location of carbonyl groups; (iv) the determination of relative configurations; (v) the determination of absolute configurations; (vi) the determination of conformation. Some examples of these applications are described in the text (see Index).

**§13. Dipole moments.** When the centres of gravity of the electrons and nuclei in a molecule do not coincide, the molecule will possess a *permanent* dipole moment,  $\mu$ , the value of which is given by  $\mu = e \times d$ , where  $e$  is the electronic charge, and  $d$  the distance between the charges (positive and negative centres). Since  $e$  is of the order of  $10^{-10}$  e.s.u., and  $d$   $10^{-8}$  cm.,  $\mu$  is therefore of the order  $10^{-18}$  e.s.u. This unit is known as the Debye (D), in honour of Debye, who did a great deal of work on dipole moments.

The dipole moment is a vector quantity, and its direction in a molecule is often indicated by an arrow parallel to the line joining the points of

charge, and pointing towards the negative end, e.g.,  $\overset{+}{\text{H}}-\overset{-}{\text{Cl}}$  (Sidgwick, 1930). The greater the value of the dipole moment, the greater is the *polarity* of the bond. It should be noted that the terms *polar* and *non-polar* are used to describe bonds, molecules and groups. Bond dipoles are produced because of the different electron-attracting powers of atoms (or groups) joined by that bond. This unequal electronegativity producing a dipole moment seems to be a satisfactory explanation for many simple molecules, but is unsatisfactory in other cases. Thus a number of factors must operate in determining the value of the dipole moment. It is now believed that *four* factors contribute to the bond moment:

(i) The unequal sharing of the bonding electrons arising from the different electronegativities of the two atoms produces a dipole moment.

(ii) In covalent bonds a dipole is produced because of the difference in size of the two atoms. The centres of gravity (of the charges) are at the nucleus of each contributing atom. Thus, if the atoms are different in size, the resultant centre of gravity is not at the mid-point of the bond, and so a bond moment results.

(iii) Hybridisation of orbitals produces asymmetric atomic orbitals; consequently the centres of gravity of the hybridised orbitals are no longer at the parent nuclei. Only if the orbitals are pure *s*, *p* or *d*, are the centres of gravity at the parent nuclei. Thus hybridised orbitals produce a bond moment.

(iv) Lone-pair electrons (e.g., on the oxygen atom in water) are not "pure" *s* electrons; they are "impure" because of hybridisation with *p* electrons. If lone-pair electrons were not hybridised, their centre of gravity would be at the nucleus; hybridisation, however, displaces the centre of gravity from the nucleus and so the asymmetric orbital produced gives rise to a bond moment which may be so large as to outweigh the contributions of the other factors to the dipole moment.

The following points are useful in organic chemistry:

(i) In the bond  $\text{H}-\text{Z}$ , where Z is any atom other than hydrogen or carbon, the hydrogen atom is the positive end of the dipole, i.e.,  $\overset{+}{\text{H}}-\overset{-}{\text{Z}}$ .

(ii) In the bond  $\text{C}-\text{Z}$ , where Z is any atom other than carbon, the carbon atom is the positive end of the dipole, i.e.,  $\overset{+}{\text{C}}-\overset{-}{\text{Z}}$  (Coulson, 1942).

(iii) When a molecule contains two or more polar bonds, the resultant dipole moment of the molecule is obtained by the vectorial addition of the constituent bond dipole moments. A symmetrical molecule will thus be non-polar, although it may contain polar bonds, *e.g.*,  $\text{CCl}_4$  has a zero dipole moment although each C—Cl bond is strongly polar.

Since dipole moments are vector quantities, the sum of two equal and opposite group moments will be zero only if the two vectors are collinear or parallel. When the group moment is directed along the axis of the bond formed by the "key" atom of the group and the carbon atom to which it is joined, then that group is said to have a *linear* moment. Such groups are H, halogen, Me, CN,  $\text{NO}_2$ , etc. On the other hand, groups which have *non-linear* moments are OH, OR,  $\text{CO}_2\text{H}$ ,  $\text{NH}_2$ , etc. This problem of linear or non-linear group moments has a very important bearing on the use of dipole data in, *e.g.*, elucidating configurations of geometrical isomers (see §5. IV), orientation in benzene derivatives (see Vol. I).

When any molecule (polar or non-polar) is placed in an electric field, the electrons are displaced from their normal positions (towards the positive pole of the external field). The positive nuclei are also displaced (towards the negative pole of the external field), but their displacement is much less than that of the electrons because of their relatively large masses. These displacements give rise to an *induced* dipole, and this exists only while the external electric field is present. The value of the induced dipole depends on the strength of the external field and on the *polarisability* of the molecule, *i.e.*, the ease with which the charged centres are displaced by the external field. If P is the total dipole moment,  $P_\mu$  the permanent dipole moment, and  $P_\alpha$  the induced dipole moment, then

$$P = P_\mu + P_\alpha$$

$P_\mu$  decreases as the temperature rises, but  $P_\alpha$  is independent of the temperature. The value of P *in solution* depends on the nature of the solvent and on the concentration.

By means of dipole moment measurements, it has been possible to get a great deal of information about molecules, *e.g.*,

(i) Configurations of molecules have been ascertained, *e.g.*, water has a dipole moment and hence the molecule cannot be linear. In a similar way it has been shown that ammonia and phosphorus trichloride are not flat molecules.

(ii) Orientations in benzene derivatives have been examined by dipole moments (see Vol. I). At the same time, this method has shown that the benzene molecule is flat.

(iii) Dipole moment measurements have been used to distinguish between geometrical isomers (see §5. IV).

(iv) Dipole moments have been used to demonstrate the existence of resonance and to elucidate electronic structures.

(v) Energy differences between different conformations (see §4a. II) have been calculated from dipole moment data.

(vi) The existence of dipole moments gives rise to association, the formation of molecular complexes, etc.

**§14. Magnetic susceptibility.** When a substance is placed in a magnetic field, the substance may or may not become magnetised. If I is the *intensity of magnetisation* induced, and H the strength of the magnetic field inducing it, then the **magnetic susceptibility**,  $\kappa$ , is given by

$$\kappa = \frac{I}{H}$$

The *magnetic induction*,  $B$ , is given by

$$B = H + 4\pi I$$

$$\text{Since } I = \kappa H, \quad B = H(1 + 4\pi\kappa)$$

The quantity  $1 + 4\pi\kappa$  is called the *magnetic permeability*,  $\mu$ .

Elements other than iron, nickel and cobalt (which are *ferromagnetic*) may be divided into two groups:

(i) **Paramagnetic**: in this group  $\mu$  is greater than unity and  $\kappa$  is therefore positive.

(ii) **Diamagnetic**: in this group  $\mu$  is less than unity and  $\kappa$  is therefore negative.

All compounds are either paramagnetic or diamagnetic. Paramagnetic substances possess a permanent magnetic moment and consequently orient themselves along the external magnetic field. Diamagnetic substances do not possess a permanent magnetic moment, and tend to orient themselves at right angles to the external magnetic field.

Electrons, because of their spin, possess magnetic dipoles. When electrons are paired (*i.e.*, their spins are anti-parallel), then the magnetic field is cancelled out. Most organic compounds are diamagnetic, since their electrons are paired. "Odd electron molecules", however, are paramagnetic (see also §19).

Magnetic susceptibility has been used to obtain information on the nature of bonds and the configuration of co-ordination compounds. Organic compounds which are paramagnetic are generally free radicals (odd electron molecules), and the degree of dissociation of, *e.g.*, hexaphenylethane into triphenylmethyl has been measured by means of its magnetic susceptibility.

**§15. Absorption spectra.** When light (this term will be used for electromagnetic waves of any wavelength) is absorbed by a molecule, the molecule undergoes transition from a state of lower to a state of higher energy. If the molecule is monatomic, the energy absorbed can only be used to raise the energy levels of electrons. If, however, the molecule consists of more than one atom, the light absorbed may bring about changes in electronic, rotational or vibrational energy. Electronic transitions give absorption (or emission) in the visible and ultraviolet parts of the spectrum, whereas rotational and vibrational changes give absorption (or emission) respectively in the far and near infra-red. Electronic transitions may be accompanied by the other two. A study of these energy changes gives information on the structure of molecules.

Spectrum	Wavelength ( $\text{\AA}$ )
Ultraviolet . . . . .	2000-4000
Visible . . . . .	4000-7500
Near infra-red . . . . .	7500- $15 \times 10^4$
Far infra-red . . . . .	$15 \times 10^4$ - $100 \times 10^4$

The position of the absorption band can be given as the wavelength  $\lambda$  (cm.,  $\mu$ ,  $\text{A}$ ,  $m\mu$ ) or as the wave number,  $\bar{\nu}$  ( $\text{cm.}^{-1}$ ).

$$1 \mu (\text{micron}) = 10^{-3} \text{ mm.} \quad 1 m\mu (\text{millimicron}) = 10^{-6} \text{ mm.}$$

$$1 \text{ \AA} (\text{Angstrom}) = 10^{-8} \text{ cm.} = 10^{-7} \text{ mm.} \quad 1 m\mu = 10 \text{ \AA.}$$

$$\lambda (\mu) = \frac{10^4}{\bar{\nu} (\text{cm.}^{-1})}$$

$$\bar{\nu} (\text{cm.}^{-1}) = \frac{1}{\lambda (\text{cm.})} = \frac{10^4}{\lambda (\mu)} = \frac{10^8}{\lambda (\text{\AA})}$$

If  $I_0$  is the intensity of an incident beam of monochromatic light, and  $I$  that of the emergent beam which has passed through an absorbing medium of thickness  $l$ , then

$$I = I_0 10^{-\epsilon l} \quad \text{or} \quad \log_{10} \frac{I_0}{I} = \epsilon l$$

where  $s$  is the *extinction coefficient* of the medium. The ratio  $I_0/I$  is called the *transmittance* of the medium, and the reciprocal the *opacity*; the function  $\log_{10} I_0/I$  is called the *density* ( $d$ ).

If the absorbing substance is in solution (the solvent being *colourless*), and if  $c$  is the concentration (number of grams per litre), then

$$I = I_0 10^{-sc}$$

This equation is **Beer's law** (1852), and is obeyed by most solutions provided they are *dilute*. In more concentrated solutions there may be divergencies from Beer's law, and these may be caused by association, changes in solvation, etc.

If the extinction coefficient is plotted against the wavelength of the light used, the *absorption curve* of the compound is obtained, and this is characteristic for a *pure* compound (under identical conditions).

**§15a. Ultraviolet and visible absorption spectra.** When a molecule absorbs light, it will be raised from the ground state to an excited state. The position of the absorption band depends on the difference between the energy levels of the ground and excited states. Any change in the structure of the molecule which alters the energy difference between the ground and excited states will thus affect the position of the absorption band. This shifting of bands (in the ultraviolet and visible regions) is concerned with the problem of colour (see Vol. I, Ch. XXXI).

With few exceptions, only molecules containing multiple bonds give rise to absorption in the near ultraviolet. In compounds containing only one multiple-bond group, the intensity of the absorption maxima may be very low, but when several of these groups are present in conjugation, the absorption is strong, *e.g.*, an isolated oxo (carbonyl) group has an absorption at  $\lambda_{\max}$ . 2750 Å; an isolated ethylene bond has an absorption at  $\lambda_{\max}$ . 1950 Å. When a compound contains an oxo group conjugated with an ethylenic bond, *i.e.*, the compound is an  $\alpha\beta$ -unsaturated oxo compound, the two bands no longer occur in their original positions, but are shifted to 3100–3300 Å and 2200–2600 Å, respectively. Thus, in a compound in which the presence of an ethylenic bond and an oxo group has been demonstrated (by chemical methods), it is also possible to tell, by examination of the ultraviolet absorption spectrum, whether the two groups are conjugated or not. (see, *e.g.*, cholestenone, §3 (ii). XI).

Ultraviolet and visible absorption spectra have also been used to differentiate between geometrical isomers and to detect the presence or absence of restricted rotation in diphenyl compounds (§2. V).

**§15b. Infra-red spectra.** In a molecule which has some definite configuration, the constituent atoms vibrate with frequencies which depend on the masses of the atoms and on the restoring forces brought into play when the molecule is distorted from its equilibrium configuration. The energy for these vibrations is absorbed from the incident light, and thereby gives rise to a vibrational spectrum. A given bond has a characteristic absorption band, but the frequency depends, to some extent, on the nature of the other atoms joined to the two atoms under consideration. It is thus possible to ascertain the nature of bonds (and therefore groups) in unknown compounds by comparing their infra-red spectra with tables of infra-red absorption spectra. At the same time it is also possible to verify tentative structures (obtained from chemical evidence) by comparison with spectra of *similar* compounds of known structure.

The study of infra-red spectra leads to information on many types of problems, *e.g.*,

(i) Infra-red spectroscopy has been used to distinguish between geo-



metrical isomers, and recently Kuhn (1950) has shown that the spectra of the stereoisomers methyl  $\alpha$ - and  $\beta$ -glycosides are different. It also appears that enantiomorphs in the *solid* phase often exhibit different absorption spectra. Infra-red spectroscopy has also been a very valuable method in conformational studies (see §11. IV).

(ii) The three isomeric disubstituted benzenes have characteristic absorption bands, and this offers a means of determining their orientation.

(iii) Infra-red spectroscopy has given a great deal of information about the problem of free rotation about a single bond; *e.g.*, since the intensity of absorption is proportional to the concentration, it has been possible to ascertain the presence and amounts of different conformations in a mixture (the intensities vary with the temperature when two or more conformations are present).

(iv) Tautomeric mixtures have been examined and the amounts of the tautomers obtained. In many cases the *existence* of tautomerism can be ascertained by infra-red spectroscopy (*cf.* iii).

(v) Infra-red spectroscopy appears to be the best means of ascertaining the presence of hydrogen bonding (both in association and chelation). In "ordinary" experiments it is not possible to distinguish between intra- and intermolecular hydrogen bonding. These two modes of bonding can, however, be differentiated by obtaining a series of spectra at different dilutions. As the dilution increases, the absorption due to intermolecular hydrogen bonding decreases, whereas the intramolecular hydrogen-bonding absorption is unaffected.

(vi) It is possible to evaluate dipole moments from infra-red spectra.

(vii) When a bond between two atoms is stretched, a restoring force immediately operates. If the distortion is *small*, the restoring force may be assumed to be directly proportional to the distortion, *i.e.*,

$$f \propto d \quad \text{or} \quad f = kd$$

where  $k$  is the *stretching force constant* of the bond. It is possible to calculate the values of these force constants from infra-red (vibrational) spectra.

(viii) The far infra-red or micro-wave region contains the *pure rotational* spectrum. Micro-wave spectroscopy (a recent development) offers a very good method for measuring bond lengths. It is possible to calculate atomic radii from bond lengths, but the value depends on whether the bond is single, double or triple, and also on the charges (if any) on the atoms concerned. Thus the character of a bond can be ascertained from its length, *e.g.*, if a bond length (determined experimentally) differs significantly from the sum of the atomic radii, then the bond is not "normal". Resonance may be the cause of this.

Some atomic covalent radii (in Angstroms) are:

H	0.30	N (single)	0.70	Cl	0.99
C (single)	0.77	N (double)	0.61	Br	1.14
C (double)	0.67	N (triple)	0.55	I	1.33
C (triple)	0.60	O (single)	0.66	S	1.04
		O (double)	0.57		

Micro-wave spectroscopy is particularly useful for information on the molecular structure of polar gases, and is also used for showing the presence of free radicals.

**§15c. Raman spectra.** When a beam of monochromatic light passes through a transparent medium, most of the light is transmitted or scattered without change in wavelength. Some of the light, however, is converted into *longer* wavelengths, *i.e.*, *lower* frequency (a smaller amount of the light may be changed into shorter wavelengths, *i.e.*, higher frequency). The

change from *higher to lower* frequency is known as the **Raman effect (Raman shift)**. It is independent of the frequency of the light used, but is characteristic for a given bond.

Raman spectra have been used to obtain information on structure, *e.g.*, the Raman spectrum of formaldehyde in aqueous solution shows the absence of the oxo group, and so it is inferred that formaldehyde is hydrated:  $\text{CH}_2(\text{OH})_2$ . Raman spectra have also been used to ascertain the existence of keto-enol tautomerism and different conformations, to provide evidence for resonance, to differentiate between geometrical isomers, to show the presence of association, and to give information on force constants of bonds.

**§16. X-ray analysis.** X-rays may be used with gases, liquids or solids, but in organic chemistry they are usually confined to solids, which may be single crystals, or substances consisting of a mass of minute crystals (*powder method*), or fibres. When X-rays (wavelength 0.7–1.5 Å) fall on solids, they are diffracted to produce patterns (formed on a photographic film). Since X-rays are diffracted mainly by the orbital electrons of the atoms, the diffraction will be a function of the atomic number. Because of this, it is difficult to differentiate between atoms whose atomic numbers are very close together, *e.g.*, carbon and nitrogen. Furthermore, since the scattering power of hydrogen atoms (for X-rays) is very low, it is normally impossible to locate these atoms except in very favourable conditions, and then only with fairly simple compounds.

Two problems are involved in the interpretation of X-ray diffraction patterns, *viz.*, the dimensions of the unit cell and the positions of the individual atoms in the molecule. The positions of the diffracted beams depend on the dimensions of the unit cell. A knowledge of these dimensions leads to the following applications:

(i) Identification of substances; this is done by looking up tables of unit cells.

(ii) Determination of molecular weights. If  $V$  is the volume of the unit cell,  $d$  the density of the compound, and  $n$  the number of molecules in a unit cell, then the molecular weight,  $M$ , is given by

$$M = \frac{Vd}{n}$$

(iii) Determination of the shapes of molecules. Many long-chain polymers exist as fibres, *e.g.*, cellulose, keratin. These fibres are composed of bundles of tiny crystals with one axis parallel, or nearly parallel, to the fibre axis. When X-rays fall on the fibre in a direction perpendicular to its length, then the pattern obtained is similar to that from a single crystal rotated about a principal axis. It is thus possible to obtain the unit cell dimensions of such fibres (see, *e.g.*, rubber, §33. VIII).

The intensities of the diffracted beams depend on the positions of the atoms in the unit cell. A knowledge of these relative intensities leads to the following applications:

(i) Determination of bond lengths, valency angles, and the general electron distribution in molecules.

(ii) Determination of molecular symmetry. This offers a means of distinguishing between geometrical isomers, and also of ascertaining the shape of a molecule, *e.g.*, the diphenyl molecule has a centre of symmetry, and therefore the two benzene rings must be coplanar (see §2. V).

(iii) Determination of structure. This application was originally used for compounds of *known* structure. Trial models based on the structure of the molecule were compared with the X-ray patterns, and if they "fitted", *confirmed* the structure already accepted. If the patterns did not fit, then it was necessary to look for another structural formula. More recently,

however, X-ray analysis has been applied to compounds of unknown or partially known structures, *e.g.*, penicillin (§6a. XVIII).

(iv) X-ray analysis has been used to elucidate the conformations of rotational isomers (§4a. II), and also to determine the *absolute* configurations of enantiomorphs (§5. II).

**§17. Electron diffraction.** Electron diffraction is another direct method for determining the spatial arrangement of atoms in a molecule, and is usually confined to gases or compounds in the vapour state, but may be used for solids and liquids. Electrons exhibit a dual behaviour, particle or wave, according to the nature of the experiment. The wavelength of electrons is inversely proportional to their momentum: the wavelength is about 0.06 Å for the voltages generally used. Because of their small diffracting power, hydrogen atoms are difficult, if not impossible, to locate.

By means of electron diffraction it is possible to obtain values of bond lengths and the size and shape of molecules, particularly macromolecules. Electron diffraction studies have been particularly useful in the investigation of conformations in *cyclohexane* compounds (see §11. IV).

**§18. Neutron crystallography.** A beam of *slow* neutrons is diffracted by crystalline substances. The equivalent wavelength of a slow beam of neutrons is 1 Å, and since this is of the order of interatomic distances in crystals, the neutrons will be diffracted. This method of analysis is particularly useful for determining the positions of *light* atoms, a problem which is very difficult, and often impossible, with X-ray analysis. Thus neutron diffraction is extremely useful for locating hydrogen atoms.

In addition to studying solids, neutron diffraction has also been applied to gases, pure liquids and solutions.

**§19. Electron spin resonance.** Electrons possess spin (and consequently a magnetic moment) and are therefore capable of interacting with an external magnetic field. The spin of *one* electron of a *covalent* pair and its resulting interaction with a magnetic field is cancelled by the equal and opposite spin of its partner (see also §14). An *unpaired* electron, however, will have an interaction that is not cancelled out and the energy of its interaction may change if its spin changes to the opposite direction (an electron has a spin quantum number  $s$ ; this can have values of  $+\frac{1}{2}$  and  $-\frac{1}{2}$ ). For an unpaired electron to change the sign of its spin in a magnetic field in the direction of greater energy, it must *absorb* energy, and it will do this if electromagnetic energy of the *appropriate* wavelength is supplied. By choosing a suitable strength for the magnetic field, the unpaired electron can be made to absorb in the micro-wave region; a field of about 3000 gauss is usually used in conjunction with radiation of a frequency in the region of 9 kMc./sec. This method of producing a spectrum is known as *electron spin resonance* (ESR) or *electron paramagnetic resonance* (EPR). ESR is used as a method for the study of free radicals; it affords a means of detecting and measuring the concentration of free radicals, and also supplies specific information about their structure. The application of ESR has shown that free radicals take part in photosynthesis.

**§19a. Nuclear magnetic resonance.** Just as electrons have spin, so have the protons and neutrons in atomic nuclei. In most nuclei the spins are not cancelled out and hence such nuclei possess a resultant nuclear magnetic moment. When the nucleus possesses a magnetic moment, the ground state consists of two or more energy levels which are indistinguishable from each other. Transition from one level to another, however, can be induced by absorption or emission of a quantum of radiation of the proper frequency which is determined by the energy difference between the

two nuclear levels. This frequency occurs in the radiofrequency region, and can be varied by changing the strength of the applied field. In this way is obtained the spectrum by the method of *nuclear magnetic resonance* (NMR). The resonance frequencies of most magnetic nuclei lie between 0.1 and 40 Mc. for fields varying from 1000 to 10,000 gauss.

Of particular importance are the nuclear properties of the proton; here we have the special case of NMR, *proton magnetic resonance*. A large proportion of the work in this field has been done with protons; protons give the strongest signals. Analysis of structure by NMR depends mainly on the fact that although the *same nucleus* is being examined, the NMR spectrum depends on the environment of that nucleus. This difference in resonance frequency has been called *chemical shift*; chemical shifts are small. Thus it is possible to identify C—H in saturated hydrocarbons and in olefins; a methyl group attached to a saturated carbon atom can be differentiated from one attached to an unsaturated one; etc.

NMR has been used to provide information on molecular structure, to identify molecules, and to examine the crystal structure of solids. It has also been used to measure keto-enol equilibria and for the detection of association, etc. NMR is also useful in conformational analysis (§4a. II) and for distinguishing between various *cis*- and *trans*-isomers (§5. IV).

#### READING REFERENCES

- Partington, *An Advanced Treatise on Physical Chemistry*, Longmans, Green. Vol. I-V (1949-1954).
- Ferguson, *Electronic Structures of Organic Molecules*, Prentice-Hall (1952).
- Ketelaar, *Chemical Constitution*, Elsevier (1953).
- Gilman, *Advanced Organic Chemistry*, Wiley (1943, 2nd ed.). (i) Vol. II. Ch. 23. Constitution and Physical Properties of Organic Compounds. (ii) Vol. III (1953). Ch. 2. Applications of Infra-red and Ultra-violet Spectra to Organic Chemistry.
- Wells, *Structural Inorganic Chemistry*, Oxford Press (1950, 2nd ed.).
- Syrkin and Dyatkina, *Structure of Molecules and the Chemical Bond*, Butterworth (1950; translated and revised by Partridge and Jordan).
- Weissberger (Ed.), *Technique of Organic Chemistry*, Interscience Publishers. Vol. I (1949, 2nd ed.). Physical Methods of Organic Chemistry.
- Berl (Ed.), *Physical Methods in Chemical Analysis*, Academic Press. Vol. I (1950); Vol. II (1951).
- Waters, *Physical Aspects of Organic Chemistry*, Routledge and Kegan Paul (1950, 4th ed.).
- Reilly and Rae, *Physico-Chemical Methods*, Methuen (Vol. I and II; 1954, 5th ed.).
- Stuart, *Die Struktur des Freien Moleküls*, Springer-Verlag (1952).
- Mizushima, *Structure of Molecules and Internal Rotation*, Academic Press (1954).
- Ingold, *Structure and Mechanism in Organic Chemistry*, Bell and Sons (1953). Ch. III. Physical Properties of Molecules.
- Braude and Nachod (Ed.), *Determination of Organic Structures by Physical Methods*, Academic Press (1955). Nachod and Phillips, Vol. 2 (1962).
- Pimental and McClellan, *The Hydrogen Bond*, Freeman and Co. (1960).
- Quayle, The Parachors of Organic Compounds, *Chem. Reviews*, 1953, 53, 439.
- Djerassi, *Optical Rotatory Dispersion*, McGraw-Hill (1960).
- Advances in Organic Chemistry*, Interscience (1960). Klyne, Optical Rotatory Dispersion and the Study of Organic Structures, Vol. I, p. 239.
- Smith, *Electric Dipole Moments*, Butterworth (1955).
- Herzberg, *Infrared and Raman Spectra*, Van Nostrand (1945).
- Whiffen, Rotation Spectra, *Quart. Reviews (Chem. Soc.)*, 1950, 4, 131.
- Bellamy, *The Infrared Spectra of Complex Molecules*, Methuen (1958, 2nd ed.).
- Cross, *Introduction to Practical Infrared Spectroscopy*, Butterworth (1959).
- Mason, Molecular Electronic Absorption Spectra, *Quart. Reviews (Chem. Soc.)*, 1961, 15, 287.
- Rose, Raman Spectra, *J. Roy. Inst. Chem.*, 1961, 83.
- Walker and Straw, *Spectroscopy*, Vol. I (1961), Chapman and Hall.
- Robertson, *Organic Crystals and Molecules*, Cornell (1953).
- Jeffrey and Cruikshank, Molecular Structure Determination by X-Ray Crystal Analysis: Modern Methods and their Accuracy, *Quart. Reviews (Chem. Soc.)*, 1953, 7, 335.
- Richards, The Location of Hydrogen Atoms in Crystals, *Quart. Reviews (Chem. Soc.)*, 1956, 10, 480.

- Ann. Review of Phys. Chem.* (Vol. I, 1950; —).
- Newman (Ed.), *Steric Effects in Organic Chemistry*, Wiley (1956). Ch. 11. Steric Effects on Certain Physical Properties.
- McMillan, Electron Paramagnetic Resonance of Free Radicals, *J. Chem. Educ.*, 1961, **38**, 438.
- Advances in Organic Chemistry*, Interscience (1960). Conroy, Nuclear Magnetic Resonance in Organic Structural Elucidation, Vol. 2, p. 265.
- Corio, The Analysis of Nuclear Magnetic Resonance Spectra, *Chem. Reviews*, 1960, **60**, 363.
- Roberts, Nuclear Magnetic Resonance Spectroscopy, *J. Chem. Educ.*, 1961, **37**, 581.
- Durrant and Durrant, *Introduction to Advanced Inorganic Chemistry*, Longmans, Green (1962). Ch. 1-12 (Quantum Theory, Valency, Spectra, etc.).

CHAPTER II  
OPTICAL ISOMERISM

§1. **Stereoisomerism.** Stereochemistry is the "chemistry of space", *i.e.*, stereochemistry deals with the *spatial* arrangements of atoms and groups in a molecule. **Stereoisomerism** is exhibited by isomers having the *same* structure but differing in their spatial arrangement, *i.e.*, having different *configurations*. Different configurations are possible because carbon forms mainly covalent bonds and these have direction in space. The covalent bond is formed by the overlapping of atomic orbitals, the bond energy being greater the greater the overlap of the component orbitals. To get the maximum overlap of orbitals, the orbitals should be in the same plane. Thus *non-spherical* orbitals tend to form bonds in the direction of the greatest concentration of the orbital, and this consequently produces a *directional* bond (see also Vol. I, Ch. II).

There are two types of stereoisomerism, **optical isomerism** and **geometrical isomerism** (*cis-trans* isomerism). It is not easy to define them, but their meanings will become clear as the study of stereochemistry progresses. Even so, it is highly desirable to have some idea about their meanings at this stage, and so the following summaries are given.

**Optical isomerism** is characterised by compounds having the same structure but different configurations, and because of their *molecular asymmetry* these compounds rotate the plane of polarisation of plane-polarised light. Optical isomers have similar physical and chemical properties; the most marked difference between them is their action on plane-polarised light (see §12. I). Optical isomers may rotate the plane of polarisation by *equal* and *opposite* amounts; these optical isomers are **enantiomorphs** (see §4). On the other hand, some optical isomers may rotate the plane of polarisation by *different* amounts; these are **diastereoisomers** (see §7b). Finally, some optical isomers may possess no rotation at all; these are diastereoisomers of the *meso*-type (see §7d).

**Geometrical isomerism** is characterised by compounds having the same structure but different configurations, and because of their *molecular symmetry* these compounds do *not* rotate the plane of polarisation of plane-polarised light. Geometrical isomers differ in all their physical and in many of their chemical properties. They can also exhibit optical isomerism if the structure of the molecule, apart from giving rise to geometrical isomerism, is also asymmetric. In general, geometrical isomerism involves molecules which can assume different stable configurations, the ability to do so being due, *e.g.*, to the presence of a double bond, a ring structure, or the steric effect (see Ch. IV and V).

§2. **Optical isomerism.** It has been found that only those structures, crystalline or molecular, which are *not* superimposable on their mirror images, are optically active. Such structures may be *dissymmetric*, or *asymmetric*. Asymmetric structures have no elements of symmetry at all, but dissymmetric structures, although possessing some elements of symmetry, are nevertheless still capable of existing in two forms (one the mirror image of the other) which are not superimposable. To avoid unnecessary complications, we shall use the term asymmetric to cover both cases (of asymmetry and dissymmetry).

A given molecule which has at least one element of symmetry (§6) when its "classical" configuration (*i.e.*, the Fischer projection formula; §5) is

inspected may, however, have a conformation (§4a) which is devoid of any element of symmetry. At first sight, such a molecule might be supposed to be optically active. In practice, however, it is not; individual molecules are optically active, but statistically, the whole collection of molecules is not. It therefore follows that when a molecule can exist in one or more conformations, then provided that at least one of the conformations (whether preferred or not) is superimposable on its mirror image, the compound will not be optically active (see §11 for a discussion of this problem).

**Optical activity due to crystalline structure.** There are many substances which are optically active in the solid state only, *e.g.*, quartz, sodium chlorate, benzil, etc. Let us consider quartz, the first substance shown to be optically active (Arago, 1811). Quartz exists in two crystalline forms, one of which is dextrorotatory and the other lævorotatory. These two forms are mirror images and are not superimposable. Such pairs of crystals are said to be *enantiomorphous* (quartz crystals are actually hemihedral and are mirror images). X-ray analysis has shown that the quartz crystal lattice is built up of silicon and oxygen atoms arranged in left- and right-handed spirals. One is the mirror image of the other, and the two are not superimposable. When quartz crystals are fused, the optical activity is lost. Therefore the optical activity is entirely due to the *asymmetry of the crystalline structure*, since fusion brings about only a physical change. Thus we have a group of substances which are optically active only so long as they remain solid; fusion, vaporisation or solution in a solvent causes loss of optical activity.

**Optical activity due to molecular structure.** There are many compounds which are optically active in the solid, fused, gaseous or dissolved state, *e.g.*, glucose, tartaric acid, etc. In this case the optical activity is entirely due to the *asymmetry of the molecular structure* (see, however, §11). The original molecule and its non-superimposable mirror image are known as *enantiomorphs* (this name is taken from crystallography) or *optical antipodes*. They are also often referred to as *optical isomers*, but there is a tendency to reserve this term to denote *all* isomers which have the same structural formula but different configurations (see §1).

**Properties of enantiomorphs.** It appears that enantiomorphs are identical physically except in two respects:

(i) their manner of rotating polarised light; the rotations are equal but opposite.

(ii) the absorption coefficients for dextro- and lævocircularly polarised light are different; this difference is known as *circular dichroism* or the *Cotton effect* (see also §8. III).

The crystal forms of enantiomorphs may be mirror images of each other, *i.e.*, the crystals themselves may be enantiomorphous, but this is unusual [see also §10(i)]. Enantiomorphs are similar chemically, but their rates of reaction with other optically active compounds are usually different [see §10(vii)]. They may also be different physiologically, *e.g.*, (+)-histidine is sweet, (-)-tasteless; (-)-nicotine is more poisonous than (+)-.

**§3. The tetrahedral carbon atom.** In 1874, van't Hoff and Le Bel, independently, gave the solution to the problem of optical isomerism in organic compounds. van't Hoff proposed the theory that if the four valencies of the carbon atom are arranged tetrahedrally (not necessarily regular) with the carbon atom at the centre, then all the cases of isomerism known are accounted for. Le Bel's theory is substantially the same as van't Hoff's, but differs in that whereas van't Hoff believed that the valency distribution was definitely tetrahedral and fixed as such, Le Bel believed that the valency directions were not rigidly fixed, and did not specify the tetrahedral arrangement,

but thought that *whatever* the spatial arrangement, the molecule *Cabde* would be *asymmetric*. Later work has shown that van't Hoff's theory is more in keeping with the facts (see below). Both van't Hoff's and Le Bel's theories were based on the assumption that the four hydrogen atoms in methane are equivalent; this assumption has been shown to be correct by means of chemical and physico-chemical methods. Before the tetrahedral was proposed, it was believed that the four carbon valencies were planar, with the carbon atom at the centre of a square (Kekulé, 1858).

Pasteur (1848) stated that all substances fell into two groups, those which were superimposable on their mirror images, and those which were not. In substances such as quartz, optical activity is due to the dissymmetry of the *crystal* structure, but in compounds like sucrose the optical activity is due to *molecular* dissymmetry. Since it is impossible to have molecular dissymmetry if the molecule is flat, Pasteur's work is based on the idea that molecules are three-dimensional and arranged dissymmetrically. A further interesting point in this connection is that Pasteur quoted an irregular tetrahedron as one example of a dissymmetric structure. Also, Paterno (1869) had proposed *tetrahedral models* for the structure of the isomeric compounds  $C_2H_4Cl_2$  (at that time it was thought that there were three isomers with this formula; one ethylidene chloride and two ethylene chlorides).

**§3a. Evidence for the tetrahedral carbon atom.** The molecule  $CX_4$  constitutes a five-point system, and since the four valencies of carbon are equivalent, their disposition in space may be assumed to be symmetrical. Thus there are three symmetrical arrangements possible for the molecule  $CX_4$ , one planar and two solid—pyramidal and tetrahedral. By comparing the number of isomers that have been prepared for a given compound with the number predicted by the above three spatial arrangements, it is possible to decide which one is correct.

*Compounds of the types  $Ca_2b_2$  and  $Ca_2bd$ .* Both of these are similar, and so we shall only discuss molecule  $Ca_2b_2$ .

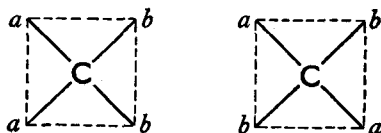

FIG. 2.1.

(i) If the molecule is planar, then *two* forms are possible (Fig. 1). This planar configuration can be either square or rectangular; in each case there are two forms only.

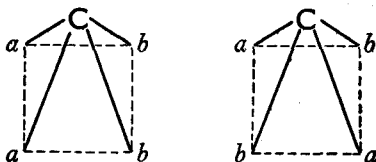

FIG. 2.2.

(ii) If the molecule is pyramidal, then *two* forms are possible (Fig. 2). There are only two forms, whether the base is square or rectangular.

(iii) If the molecule is tetrahedral, then only *one* form is possible (Fig. 3; the carbon atom is at the centre of the tetrahedron).



In practice, only one form is known for each of the compounds of the types  $Ca_2b_2$  and  $Ca_2bd$ ; this agrees with the tetrahedral configuration.

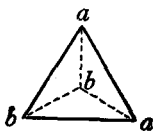

FIG. 2.3.

Compounds of the type  $Cabde$ . (i) If the molecule is planar, then three forms are possible (Fig. 4).

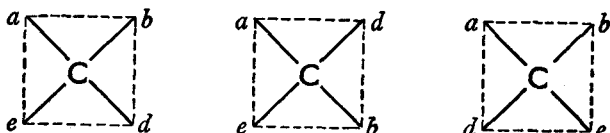

FIG. 2.4.

(ii) If the molecule is pyramidal, then six forms are possible; there are three pairs of enantiomorphs. Each of the forms in Fig. 4, drawn as a pyramid, is not superimposable on its mirror image, e.g., Fig. 5 shows one pair of enantiomorphs.

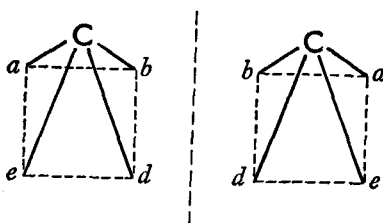

FIG. 2.5.

(iii) If the molecule is tetrahedral, there are two forms possible, one related to the other as object and mirror image, which are not superimposable, i.e., the tetrahedral configuration gives rise to one pair of enantiomorphs (Fig. 6).

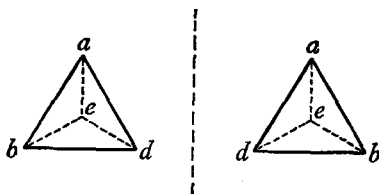

FIG. 2.6.

In practice, compounds of the type  $Cabde$  give rise to only one pair of enantiomorphs; this agrees with the tetrahedral configuration.

When a compound contains four different groups attached to a carbon atom, that carbon atom is said to be asymmetric (actually, of course, it is the group which is asymmetric; a carbon atom cannot be asymmetric). The majority of optically active compounds (organic) contain one or more asymmetric carbon atoms. It should be remembered, however, that the essential requirement for optical activity is the asymmetry of the molecule.

A molecule may contain two or more asymmetric carbon atoms and still not be optically active (see, *e.g.*, §7d).

A most interesting case of an optically active compound containing one asymmetric carbon atom is the resolution of *s*-butylmercuric bromide,  $\text{EtMeCH}\cdot\text{HgBr}$  (Hughes, Ingold *et al.*, 1958). This appears to be the first example of the resolution of a simple organometallic compound where the asymmetry depends only on the carbon atom attached to the metal.

**Isotopic asymmetry.** In the optically active compound *Cabde*, the groups *a*, *b*, *d* and *e* (which may or may not contain carbon) are all different, but two or more may be *structural* isomers, *e.g.*, propylisopropylmethanol is optically active. The substitution of hydrogen by deuterium has also been investigated in recent years to ascertain whether these two atoms are sufficiently different to give rise to optical isomerism. The earlier work gave conflicting results, *e.g.*, Clemo *et al.* (1936) claimed to have obtained a small rotation for  $\alpha$ -pentadeuterophenylbenzylamine,  $\text{C}_6\text{D}_5\cdot\text{CH}(\text{C}_6\text{H}_5)\cdot\text{NH}_2$ , but this was disproved by Adams *et al.* (1938). Erlenmeyer *et al.* (1936) failed to resolve  $\text{C}_6\text{H}_5\cdot\text{CH}(\text{C}_6\text{D}_5)\cdot\text{CO}_2\text{H}$ , and Ives *et al.* (1948) also failed to resolve a number of deuterio-compounds, one of which was



More recent work, however, is definitely conclusive in favour of optical activity, *e.g.*, Eliel (1949) prepared optically active phenylmethyldeuterio-methane,  $\text{CH}_3\cdot\text{CHD}\cdot\text{C}_6\text{H}_5$ , by reducing optically active phenylmethylmethyl chloride,  $\text{CH}_3\cdot\text{CHCl}\cdot\text{C}_6\text{H}_5$ , with lithium aluminium deuteride; Ross *et al.* (1956) have prepared (–)-2-deuterobutane by reduction of (–)-2-chlorobutane with lithium aluminium deuteride; and Alexander *et al.* (1949) reduced *trans*-2-*p*-menthene with deuterium (Raney nickel catalyst) and obtained a 2:3-dideutero-*trans*-*p*-menthane (I) that was slightly laevo-rotatory. Alexander (1950) also reduced (–)-menthyl toluene-*p*-sulphonate and obtained an optically active 3-deutero-*trans*-*p*-menthane (II).

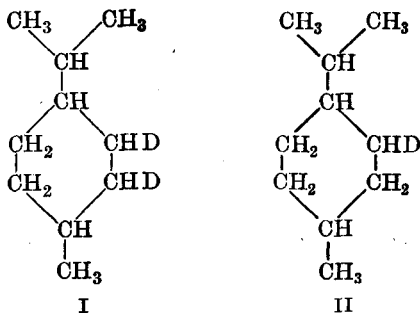

Some other optically active compounds with deuterium asymmetry are, *e.g.*, (III; Streitwieser, 1955) and (IV; Levy *et al.*, 1957):

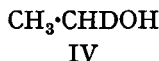
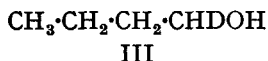

A point of interest here is that almost all optically active deuterium compounds have been prepared from optically active precursors. Exceptions are (V) and (VI), which have been resolved by Pocker (1961).



#### Further evidence for the tetrahedral carbon atom

(i) Conversion of the *two* forms (enantiomorphs) of the molecule *Cabde*

into  $Ca_b d$  results in the formation of *one* compound only (and disappearance of optical activity), *e.g.*, both dextro- and lævrotatory lactic acid may be reduced to the *same* propionic acid, which is not optically active. These results are possible only with a tetrahedral arrangement (Fig. 7; see §5 for the convention for drawing tetrahedra).

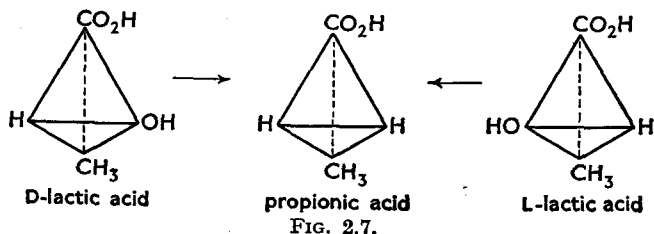

(ii) If the configuration is tetrahedral, then interchanging any two groups in the molecule  $Cabde$  will produce the enantiomorph, *e.g.*,  $b$  and  $e$  (see Fig. 8). Fischer and Brauns (1914), starting with (+)-*isopropylmalonamic*

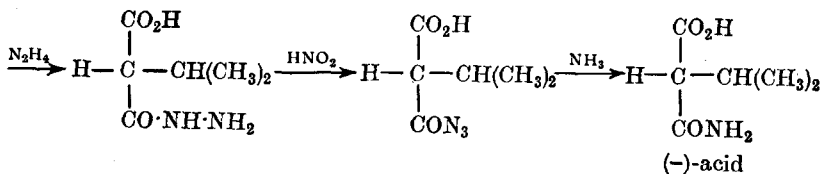
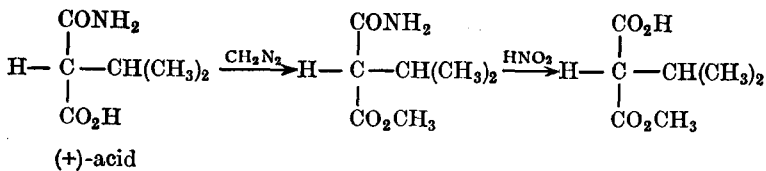
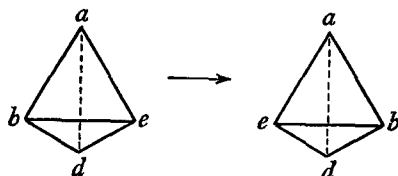

acid, carried out a series of reactions whereby the carboxyl and the carbonamide groups were interchanged; the product was (–)-*isopropylmalonamic* acid. It is most important to note that in this series of reactions no bond connected to the asymmetric carbon atom was ever broken (for an explanation, see Walden Inversion, Ch. III).

This change from one enantiomorph into the other is in agreement with the tetrahedral theory. At the same time, this series of reactions shows that optical isomers have identical structures, and so the difference must be due to the spatial arrangement.

(iii) X-ray crystallography, dipole moment measurements, absorption spectra and electron diffraction studies show that the four valencies of carbon are arranged tetrahedrally with the carbon atom inside the tetrahedron.

It should be noted in passing that the tetrahedra are not regular unless four identical groups are attached to the central carbon atom; only in this

case are the four bond lengths equal. In all other cases the bond lengths will be different, the actual values depending on the nature of the atoms joined to the carbon atom (see §15b. I).

§4. Two postulates underlie the tetrahedral theory.

(i) **The principle of constancy of the valency angle.** Mathematical calculation of the angle subtended by each side of a regular tetrahedron at the central carbon atom (Fig. 9) gives a value of  $109^{\circ} 28'$ . Originally, it was postulated (van't Hoff) that the valency angle was fixed at this value. It is now known, however, that the valency angle may deviate from this value. The four valencies of carbon are formed by hybridisation of the

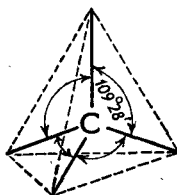

FIG. 2.9.

$2s^2$  and  $2p^2$  orbitals, *i.e.*, there are four  $sp^3$  bonds (see Vol. I, Ch. II). Quantum mechanical calculations show that the four carbon valencies in the molecule  $Ca_4$  are equivalent and directed towards the four corners of a regular tetrahedron. Furthermore, quantum-mechanical calculations require the carbon bond angles to be close to the tetrahedral value, since change from this value is associated with loss in bond strength and consequently decrease in stability. According to Coulson *et al.* (1949), calculation has shown that the *smallest* valency angle that one can reasonably expect to find is  $104^{\circ}$ . It is this value which is found in the *cyclopropane* and *cyclobutane* rings, these molecules being relatively unstable because of the "bent" bonds (Coulson; see Baeyer Strain Theory, Vol. I, Ch. XIX).

(ii) **The principle of free rotation about a single bond.** Originally, it was believed that internal rotation about a single bond was completely free. When the thermodynamic properties were first calculated for ethane on the assumption that there was complete free rotation about the carbon-carbon single bond, the results obtained were in poor agreement with those obtained experimentally. This led Pitzer *et al.* (1936) to suggest that there

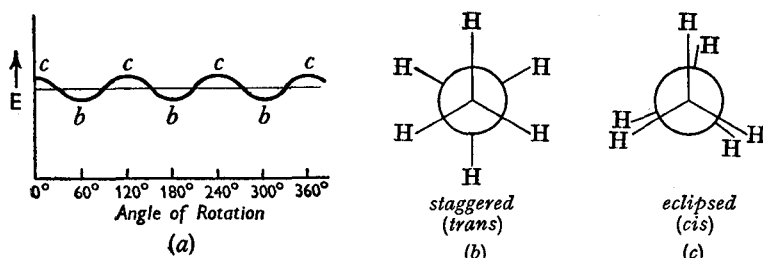

FIG. 2.10.

was restricted rotation about the single bond, and calculations on this basis gave thermodynamic properties in good agreement with the experimental ones. The potential energy curve obtained for ethane, in which one methyl group is imagined to rotate about the C—C bond as axis with the other group at rest, is shown in Fig. 10 (a). Had there been complete free rotation, the graph would have been a horizontal straight line. Fig. 10 (b) is the Newman (1952) projection formula, the carbon atom nearer to the eye

being designated by equally spaced radii and the carbon atom further from the eye by a circle with three equally spaced radial extensions. Fig. 10 (b) represents the *trans-* or **staggered** form in which the hydrogen atoms (on the two carbon atoms) are as far apart as possible. Fig. 10 (c) represents the *cis-* or **eclipsed** form in which the hydrogen atoms are as close together as possible. It can be seen from the graph that the eclipsed form has a higher potential energy than the staggered, and the actual difference has been found to be (by calculation) about 2.85 kg.cal./mole. The value of

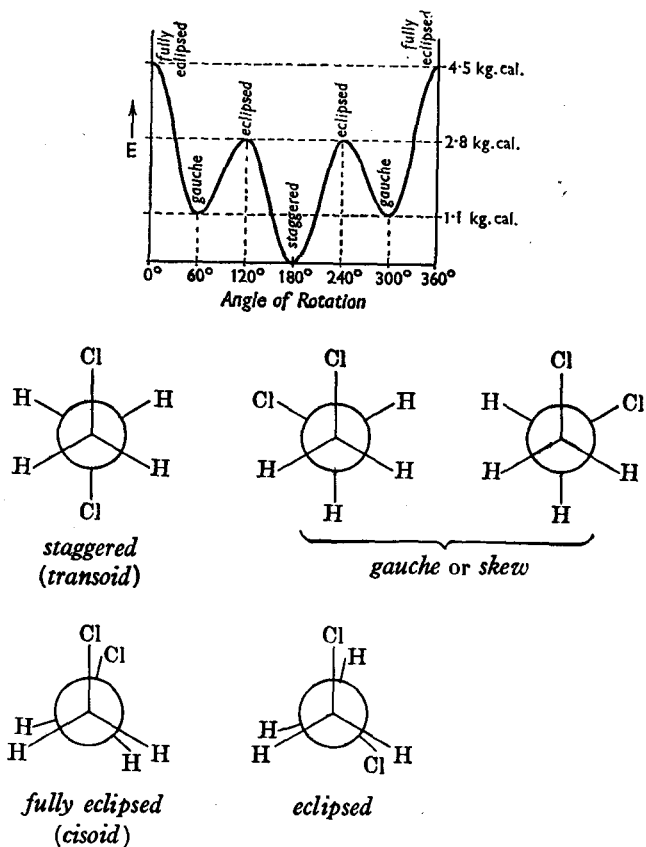

FIG. 2.11 (i).

this potential energy barrier is too low to permit the isolation of each form by chemical methods.

Now let us consider the case of ethylene chloride. According to Bernstein (1949), the potential energy of ethylene chloride undergoes the changes shown in Fig. 2.11 (i) when one  $\text{CH}_2\text{Cl}$  group is rotated about the C—C bond with the other  $\text{CH}_2\text{Cl}$  at rest. There are two positions of minimum energy, one corresponding to the staggered (transoid) form and the other to the gauche (skew) form, the latter possessing approximately 1.1 kg.cal. more than the former. The fully eclipsed (cisoid) form possesses about 4.5 kg.cal. more energy than the staggered form and thus the latter is the preferred form, *i.e.*, the molecule is largely in this form. Dipole moment studies show that this is so in practice, and also show (as do Raman spectra studies) that the ratio of the two forms varies with the temperature. Furthermore,

infra-red, Raman spectra and electron diffraction studies have shown that the gauche form is also present. According to Mizushima *et al.* (1938), only the staggered form is present at low temperatures.

The problem of internal rotation about the central C—C bond in *n*-butane is interesting, since the values of the potential energies of the various forms have been used in the study of cyclic compounds (see *cyclohexane*, §11. IV). The various forms are shown in Fig. 2.11 (ii), and if the energy content of the staggered form is taken as zero, then the other forms have the energy contents shown (Pitzer, 1951).

From the foregoing account it can be seen that, in theory, there is no free

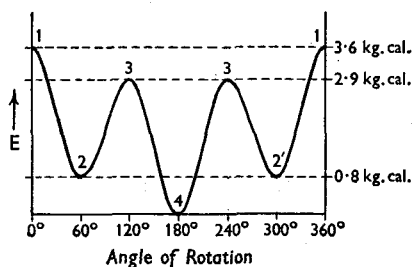
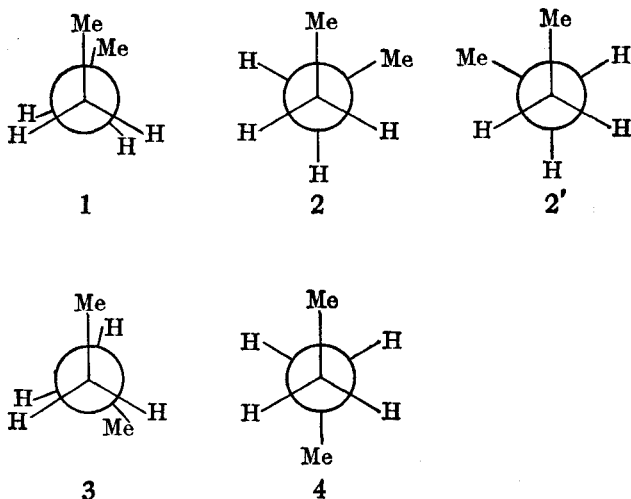

FIG. 2.11 (ii).



rotation about a single bond. In practice, however, it may occur if the potential barriers of the various forms do not differ by more than about 10 kg.cal./mole. Free rotation about a single bond is generally accepted in *simple* molecules. Restricted rotation, however, may occur when the molecule contains groups large enough to impede free rotation, *e.g.*, in *ortho*-substituted diphenyls (see Ch. V). In some cases resonance can give rise to restricted rotation about a "single" bond.

**§4a. Conformational analysis.** Molecules which can form isomers by rotation about single bonds are called **flexible molecules**, and the different forms taken up are known as different **conformations**. The terms *rotational isomers* and *constellations* have also been used in the same sense as conformations.

Various definitions have been given to the term *conformation* (which was

originally introduced by W. N. Haworth, 1929). In its widest sense, conformation has been used to describe different spatial arrangements of a molecule which are not superimposable. This means, in effect, that the terms *conformation* and *configuration* are equivalent. There is, however, an important difference in meaning between these terms. The definition of configuration, in the classical sense (§1), does not include the problem of the internal forces acting on the molecule. The term conformation, however, is the spatial arrangement of the molecule when all the internal forces acting on the molecule are taken into account. In this more restricted sense, the term conformation is used to designate different spatial arrangements arising by twisting or rotation of bonds of a *given* configuration (used in the classical sense).

The existence of potential energy barriers between the various conformations shows that there are internal forces acting on the molecule. The nature of these interactions that prevent free rotation about single bonds, however, is not completely clear. According to one theory, the hindering of internal rotation is due to dipole-dipole forces. Calculation of the dipole moment of ethylene chloride on the assumption of free rotation gave a value not in agreement with the experimental value. Thus free rotation cannot be assumed, but on the assumption that there is interaction between the two groups through dipole-dipole attractive or repulsive forces, there will be preferred conformations, *i.e.*, the internal rotation is not completely free. This restricted rotation is shown by the fact that the dipole moment of ethylene chloride increases with temperature; in the staggered form the dipole moment is zero, but as energy is absorbed by the molecule, rotation occurs to produce finally the eclipsed form in which the dipole moment is a maximum. Further work, however, has shown that factors other than dipole-dipole interactions must also be operating in opposing the rotation. One of these factors is **steric repulsion**, *i.e.*, repulsion between the non-bonded atoms (of the rotating groups) when they are brought into close proximity (*cf.* the van der Waals forces, §2. I). The existence of steric repulsion may be illustrated by the fact that although the bond moment of C—Cl is greater than that of C—Br, the energy difference between the eclipsed and staggered conformations of ethylene chloride is less than that of ethylene bromide. Furthermore, if steric repulsion does affect internal rotation, then in the ethylene halides, steric repulsion between the hydrogen and halogen atoms, if sufficiently large, will give rise to two other potential energy minima (these correspond to the two *gauche* forms, and these have been shown to be present; see Fig. 2.11 (i), §4).

Other factors also affect stability of the various conformations. Staggered and *gauche* forms always exist in molecules of the type  $\text{CH}_2\text{Y}\cdot\text{CH}_2\text{Z}$  (where Y and Z are Cl, Br, I,  $\text{CH}_3$ , etc.), and usually the staggered form is more stable than the *gauche*. In a molecule such as ethylene chlorohydrin, however, it is the *gauche* form which is more stable than the staggered, and this is due to the fact that intramolecular hydrogen bonding is possible in the former but not in the latter.

In addition to the factors already mentioned, there appear to be other factors that cause the absence of complete free rotation about a single bond, *e.g.*, the energy barrier in ethane is too great to be accounted for by steric repulsion only. Several explanations have been offered; *e.g.*, Pauling (1958) has proposed that the energy barrier in ethane (and in similar molecules) results from repulsions between adjacent bonding pairs of electrons, *i.e.*, the bonding pairs of the C—H bonds on one carbon atom repel those on the other carbon atom. Thus the preferred conformation will be the staggered one (*cf.* §1. VI). It is still possible, however, that steric repulsion is also present, and this raises the barrier height.

When the stability of a molecule is decreased by internal forces produced by interaction between constituent parts, that molecule is said to be under **steric strain**. There are three sources of steric strain, *i.e.*, the internal forces may arise from three different causes, *viz.*, (i) repulsion between non-bonded atoms, (ii) dipole interactions and (iii) distortion of bond-angles. Which of these plays the predominant part depends on the nature of the molecule in question. This study of the existence of preferred conformations in molecules, and the relating of physical and chemical properties of a molecule to its preferred conformation, is known as **conformational analysis**. The energy differences between the various conformations determine which one is the most stable, and the ease of transformation depends on the potential energy barriers that exist between these conformations. It should be noted that the molecule, in its *unexcited* state, will exist largely in the conformation of lowest energy content. If, however, the energy differences between the various conformations are small, then when *excited*, the molecule can take up a less favoured conformation, *e.g.*, during the course of reaction with other molecules (see §11. IV).

Because of the different environments a reactive centre may have in different conformations, conformation will therefore affect the course and rate of reactions involving this centre (see §11. IV).

Many methods are now used to investigate the conformation of molecules, *e.g.*, thermodynamic calculations, dipole moments, electron and X-ray diffraction, infra-red and Raman spectra, rotatory dispersion, NMR and chemical methods.

**§5. Conventions used in stereochemistry.** The original method of indicating enantiomorphs was to prefix each one by *d* or *l* according as it was dextrorotatory or lævorotatory. van't Hoff (1874) introduced a + and - notation for designating the configuration of an asymmetric carbon atom. He used mechanical models (built of tetrahedra), and the + and - signs were given by observing the tetrahedra of the mechanical model from the centre of the model. Thus a molecule of the type *Cabd·Cabd* may be designated ++, --, and +-. E. Fischer (1891) pointed out that this + and - notation can lead to wrong interpretations when applied to molecules containing more than two asymmetric carbon atoms (the signs given to each asymmetric carbon atom depend on the point of observation in the molecule). Fischer therefore proposed the use of plane projection diagrams of the mechanical models instead of the + and - system.

Fischer, working on the configurations of the sugars (see §1. VII), obtained the plane formulæ I and II for the enantiomorphs of saccharic acid, and

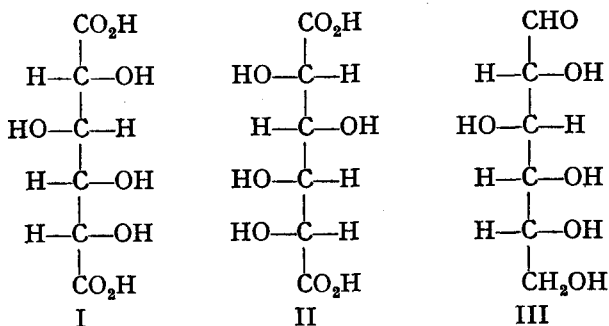

**arbitrarily** chose I for dextrorotatory saccharic acid, and called it *d*-saccharic acid. He then, from this, deduced formula III for *d*-glucose. Furthermore, Fischer thought it was more important to indicate stereo-



chemical relationships than merely to indicate the actual direction of rotation. He therefore proposed that the **prefixes *d* and *l* should refer to stereochemical relationships and not to the direction of rotation of the compound.** For this scheme to be self-consistent (among the sugars) it is necessary to choose *one* sugar as standard and then refer all the others to it. Fischer apparently intended to use the scheme whereby the compounds derived from a given aldehyde sugar should be designated according to the *direction of rotation of the parent aldose.*

Natural mannose is dextrorotatory. Hence natural mannose will be *d*-mannose, and all derivatives of *d*-mannose, *e.g.*, mannonic acid, mannitol, mannose phenylhydrazone, etc., will thus belong to the *d*-series. Natural glucose is dextrorotatory. Hence natural glucose will be *d*-glucose, and all its derivatives will belong to the *d*-series. Furthermore, Fischer (1890) converted natural mannose into natural glucose as follows:

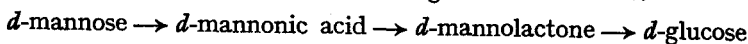

Since natural glucose is *d*-glucose (according to Fischer's scheme), the prefix *d* for natural glucose *happens* to agree with its dextrorotation (with *d*-mannose as standard). Natural fructose can also be prepared from natural mannose (or natural glucose), and so will be *d*-fructose. Natural fructose, however, is lævorotatory, and so is written as *d*(-)-fructose, the symbol *d* indicating its *stereochemical* relationship to the parent aldose glucose, and the symbol - placed in parentheses before the name indicating the *actual direction of rotation.*

More recently the symbols *d* and *l* have been replaced by D and L for configurational relationships, *e.g.*, L(+)-lactic acid. Also, when dealing with compounds that cannot be referred to an arbitrarily chosen standard, (+)- and (-)- are used to indicate the sign of the rotation. The prefixes *dextro* and *lævo* (without hyphens) are also used.

Fischer's proposal to use *each aldose* as the arbitrary standard for its derivatives leads to some difficulties, *e.g.*, natural arabinose is dextrorotatory, and so is to be designated D-arabinose. Now natural arabinose (D-arabinose) can be converted into mannonic acid which, if D-arabinose is taken as the parent aldose, will therefore be D-mannonic acid. This same acid, however, can also be obtained from L-mannose, and so should be designated as L-mannonic acid. Thus in cases such as this the use of the symbol D or L will depend on the *historical order* in which the stereochemical relationships were established. This, obviously, is an unsatisfactory position, which was realised by Rosanoff (1906), who showed that if the enantiomorphs of glyceraldehyde (a molecule which contains only *one* asymmetric carbon atom) are chosen as the (arbitrary) standard, then a satisfactory system for correlating stereochemical relationships can be developed. He also proposed that the formula of dextrorotatory glyceraldehyde should be written as in Fig. 12 (c), in order that the arrangement of its asymmetric carbon atom should agree with the arrangement of C<sub>5</sub> in Fischer's projection formula for natural glucose (see formula III above).

It is of great interest to note in this connection that in 1906 the active forms of glyceraldehyde had not been isolated, but in 1914 Wohl and Mumber separated DL-glyceraldehyde into its enantiomorphs, and in 1917 they showed that dextrorotatory glyceraldehyde was stereochemically related to natural glucose, *i.e.*, with D(+)-glyceraldehyde as arbitrary standard, natural glucose is D(+)-glucose (see §1. VII).

The accepted convention for drawing D(+)-glyceraldehyde—the agreed (*arbitrary*) standard—is shown in Fig. 12 (a). The tetrahedron is drawn so that three corners are imagined to be *above* the plane of the paper, and the fourth *below* the plane of the paper. Furthermore, the spatial arrangement

of the four groups joined to the central carbon atom *must be placed as shown in Fig. 12 (a)*, i.e., the accepted convention for drawing D(+)-glyceraldehyde places the hydrogen atom at the left and the hydroxyl group at the right, with the aldehyde group at the top corner. Now imagine the tetrahedron to rotate about the horizontal line joining H and OH until it takes up the position shown in Fig. 12 (b). This is the conventional position for a tetrahedron, groups joined to full horizontal lines

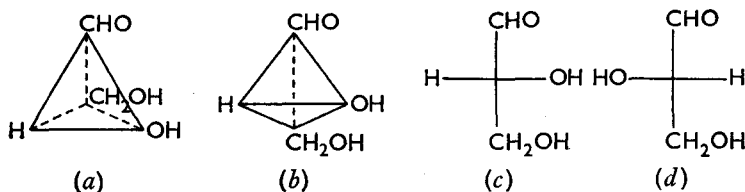
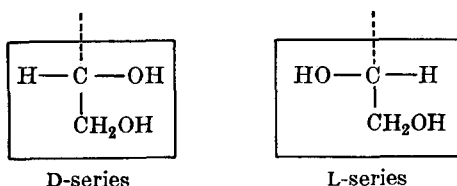

FIG. 2.12.

being above the plane of the paper, and those joined to broken vertical lines being below the plane of the paper. The conventional plane-diagram is obtained by drawing the full horizontal and broken vertical lines of Fig. 12 (b) as full lines, placing the groups as they appear in Fig. 12 (b), and taking the asymmetric carbon atom to be at the point where the lines cross. Although Fig. 12 (c) is a plane-diagram, it is most important to remember that horizontal lines represent groups above the plane, and vertical lines groups below the plane of the paper. Many authors prefer to draw Fig. 12 (c) [and Fig. 12 (d)] with a broken vertical line. Fig. 12 (d) represents the plane-diagram formula of L(-)-glyceraldehyde; here the hydrogen atom is to the right and the hydroxyl group to the left. Thus any compound that can be prepared from, or converted into, D(+)-glyceraldehyde will belong to the D-series. Similarly, any compound that can be prepared from, or converted into, L(-)-glyceraldehyde will belong to the L-series. When representing relative configurational relationship of molecules containing more than one asymmetric carbon atom, the asymmetric carbon atom of glyceraldehyde is always drawn at the bottom, the rest of the molecule being built up from this unit.



Thus we have a scheme of classification of relative configurations based on D(+)-glyceraldehyde as arbitrary standard. Even on this basis confusion is still possible in relating configurations to the standard (see later).

Until recently there was no way of determining, with certainty, the absolute configuration of molecules. Arbitrary choice makes the configuration of D(+)-glyceraldehyde have the hydrogen to the left and the hydroxyl to the right. Bijvoet *et al.* (1951), however, have shown by X-ray analysis of sodium rubidium tartrate that it is possible to differentiate between the two optically active forms, i.e., it is possible to determine the absolute configuration of these two enantiomorphs. These authors showed that natural dextrorotatory tartaric acid has the configuration assigned to it by Fischer (who correlated its configuration with that of the saccharic acids). The configurations of the tartaric acids are a troublesome problem. Fischer

wrote the configuration of natural dextrorotatory tartaric acid as IV. If we use the convention of writing the glyceraldehyde unit at the bottom,

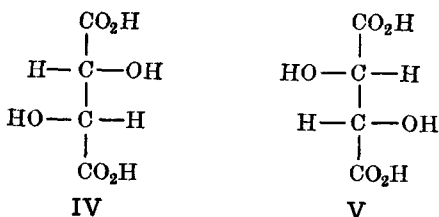

then IV is L(+)-tartaric acid and V D(-)-tartaric acid. This relationship (to glyceraldehyde) is confirmed by the conversion of D(+)-glyceraldehyde

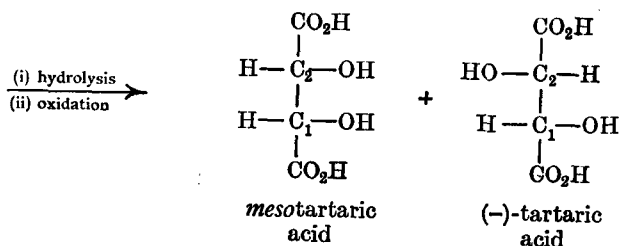
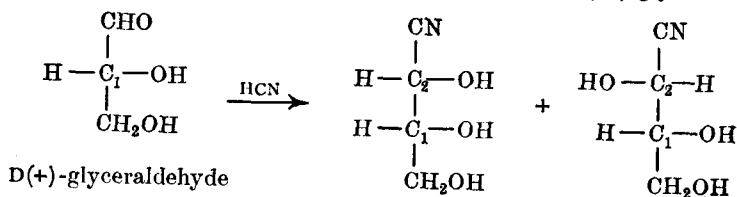

into levorotatory tartaric acid *via* the Kiliani reaction (see Vol. I). Thus (-)-tartaric acid is D(-)-tartaric acid (V). On the other hand, (+)-tartaric acid can be converted into D(-)-glyceric acid, and so (+)-tartaric acid is D(+)-tartaric acid (IV). In this reduction of (+)-tartaric acid to (+)-malic

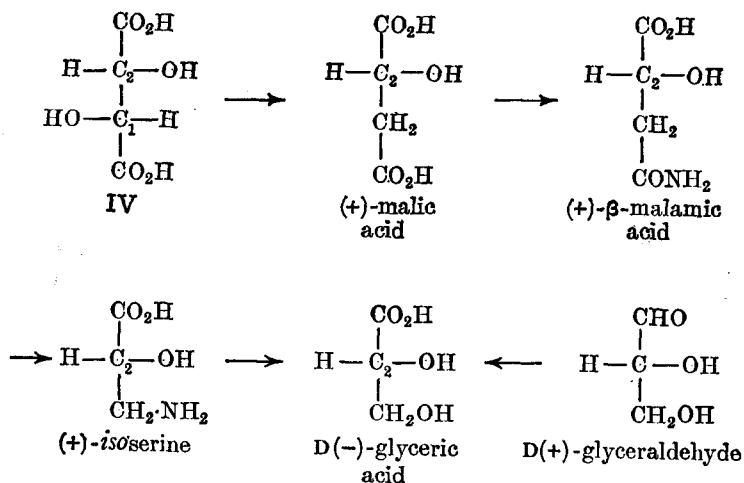

acid (by hydriodic acid), it has been *assumed* that it is  $C_1$  which has been reduced, *i.e.*, in *this* case the configuration of  $C_2$  has been correlated with glyceraldehyde and not that of  $C_1$  as in the previous set of reactions. Had, however,  $C_2$  been reduced, then the final result would have been (+)-tartaric acid *still through the intermediate*, (+)-malic acid (two exchanges of groups give the same malic acid as before). Since (+)-malic acid has been correlated

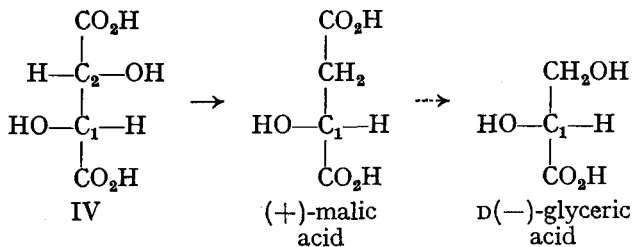

with (+)-glyceraldehyde (see §9a), (+)-tartaric acid should be designated D(+)-tartaric acid. The designation L(+)-tartaric acid is used by those chemists who regard this acid as a carbohydrate derivative (see also §5a).

**§5a. Correlation of configurations.** As we have seen (§5), since the relative configurations of (+)-tartaric acid and (+)-glyceraldehyde have been established, it is now possible to assign *absolute* configurations to many compounds whose relative configurations to (+)-glyceraldehyde are known, since the configurations assigned to them are actually the absolute configurations. The methods used for correlating configurations are:

(i) Chemical reactions without displacement at the asymmetric centre concerned (see §5b).

(ii) Chemical reactions with displacement at the asymmetric centre concerned (see the Walden inversion, §§3, 4. III).

(iii) X-ray analysis (see §5).

(iv) Asymmetric inductive correlation (see asymmetric synthesis, §7. III).

(v) Optical rotations: (a) Monochromatic rotations (see, *e.g.*, carbohydrates, §6. VII; steroids, §4b. XI). (b) Rotatory dispersion (see steroids, §4b. XI).

(vi) The study of quasi-racemic compounds (see §9a).

(vii) Enzyme studies.

**§5b. Correlation of configurations without displacement at the asymmetric centre concerned.** Since no bond joined to the asymmetric centre is ever broken, this method is an extremely valuable method of correlation. Before discussing examples, the following point is worth noting. For amino-acids, natural (–)-serine,  $\text{CH}_2\text{OH}\cdot\text{CH}(\text{NH}_2)\cdot\text{CO}_2\text{H}$ , was chosen as the arbitrary standard. Thus correlation with glyceraldehyde was indicated by  $D_g$  or  $L_g$ , and with serine by  $D_s$  or  $L_s$ . These two standards have now been correlated, and it has been shown that  $L_g \equiv L_s$ , *i.e.*, natural (–)-serine belongs to the L-series (with glyceraldehyde as absolute standard; see also §4. XIII).

The following examples illustrate this method of correlation.

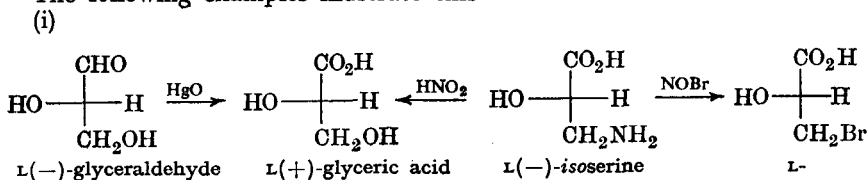

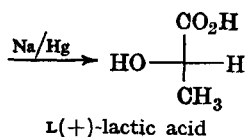

It can be seen from this example that change in the sign of rotation does not necessarily indicate a change in configuration.

(ii)

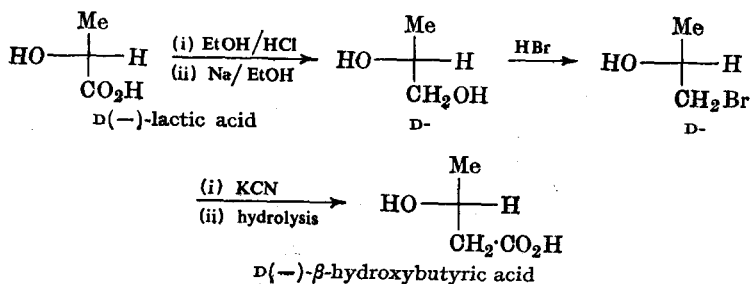

(iii)

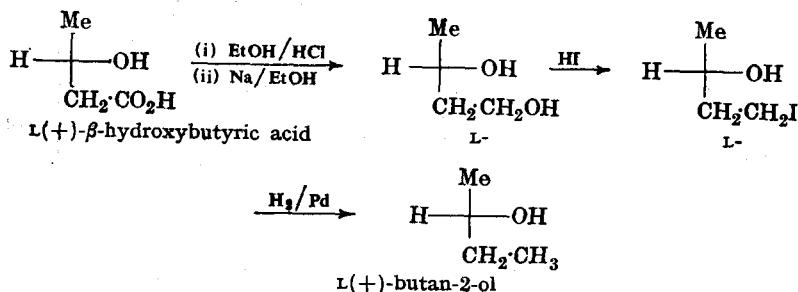

(iv) Another example is that in the terpene series (see §23e. VIII).

**§5c. Specification of asymmetric configurations.** Cahn, Ingold and Prelog (1956) have produced a scheme for the specification of absolute configurations. Let us consider the procedure for a molecule containing one asymmetric carbon atom.

(i) The four groups are first ordered according to the **sequence rule**. According to this rule, the groups are arranged in *decreasing atomic number* of the atoms by which they are bound to the asymmetric carbon atom. If two or more of these atoms have the same atomic number, then the relative priority of the groups is determined by a similar comparison of the atomic numbers of the *next* atoms in the groups (*i.e.*, the atoms joined to the atom joined to the asymmetric carbon atom). If this fails, then the next atoms of the groups are considered. Thus one works *outwards* from the asymmetric carbon atom until a selection can be made for the sequence of the groups.

(ii) Next is determined whether the sequence describes a right- or left-handed pattern on the molecular model as viewed according to the **conversion rule**. When the four groups in the molecule  $abcd$  have been ordered in the priority  $a, b, c, d$ , the conversion rule states that their spatial pattern shall be described as right- or left-handed according as the sequence  $a \rightarrow b \rightarrow c$  is clockwise or anticlockwise when viewed from an external point on the side *remote* from  $d$  (the group with the lowest priority), *e.g.*, (I) in Fig. 13 shows a right-handed (*i.e.*, clockwise) arrangement.

(iii) Absolute configuration labels are then assigned. The asymmetry leading under the sequence and conversion rules to a right- and left-handed

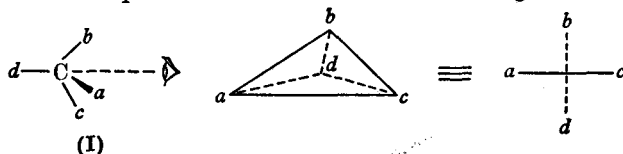
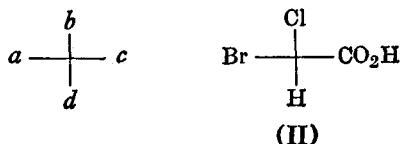

FIG. 2.13.

pattern is indicated by *R* and *S* respectively (*R*; *rectus*, right; *S*; *sinister*, left).

Let us first consider bromochloroacetic acid (II). The priority of the groups according to the sequence rule is Br (*a*), Cl (*b*), CO<sub>2</sub>H (*c*) and H (*d*).



Hence by the conversion rule, (II) is the (*R*)-form ( $a \rightarrow b \rightarrow c$  is clockwise).

Now let us consider D(+)-glyceraldehyde. By *convention* it is drawn as III (this is also the *absolute* configuration). Oxygen has the highest priority

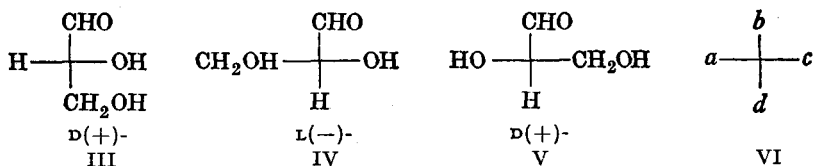

and H the lowest. Thus OH is *a* and H is *d*. Since both the CHO and CH<sub>2</sub>OH groups are attached to the asymmetric carbon by carbon, it is necessary to determine the priorities of these two groups by working outwards. The C of the CHO is bound to (H, O=) and that of the CH<sub>2</sub>OH to (H, H, OH). When a double or triple bond is present in the group, the atom at the remote end of the multiple bond is regarded as duplicated or triplicated, respectively. Thus the double-bonded oxygen atom gives higher priority to the CHO group ( $\equiv$ H, O, O). Hence CHO is *b* and CH<sub>2</sub>OH is *c*. Since the interchanging of two groups inverts the configuration, the sequence (III)  $\rightarrow$  (IV)  $\rightarrow$  (V) gives the *original* configuration. Since (V) corresponds to (VI), it thus follows that D(+)-glyceraldehyde is (*R*)-glyceraldehyde.

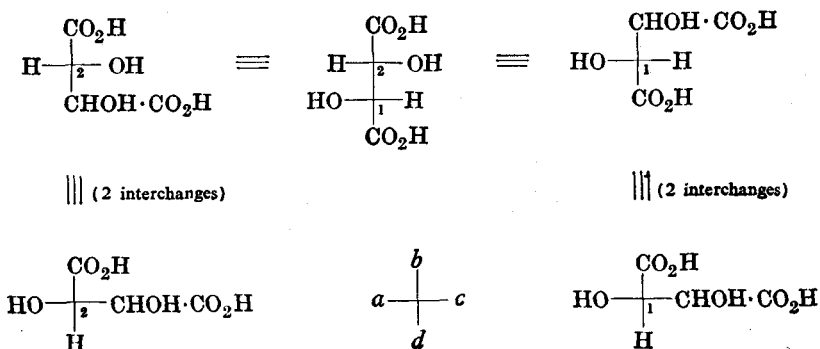

When a molecule contains two or more asymmetric carbon atoms, each asymmetric carbon atom is assigned a configuration according to the sequence and conversion rules and is then specified with *R* or *S*, e.g., (+)-tartaric acid. Thus the absolute configuration of (+)-tartaric acid is (*RR*)-tartaric acid [this clearly indicates the relationship between (+)-tartaric acid and D(+)-glyceraldehyde].

In a similar way it can be demonstrated that D(+)-glucose has the absolute configuration shown.

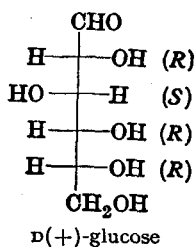

The system has also been extended to include asymmetric molecules which have no asymmetric carbon atoms, e.g., spirans, diphenyls, etc.

**§6. Elements of symmetry.** The test of superimposing a formula (tetrahedral) on its mirror image definitely indicates whether the molecule is symmetrical or not; it is asymmetric if the two forms are not superimposable. The most satisfactory way in which superimposability may be ascertained is to build up models of the molecule and its mirror image. Usually this is not convenient, and so, in practice, one determines whether the molecule possesses (i) a plane of symmetry, (ii) a centre of symmetry or (iii) an alternating axis of symmetry. If the molecule contains at least one of these elements of symmetry, the molecule is symmetrical; if none of these elements of symmetry is present, the molecule is asymmetric.

It should be remembered that it is the Fischer projection formula that is normally used for inspection. As pointed out in §2, it is necessary, when dealing with conformations, to ascertain whether at least one of them has one or more elements of symmetry. If such a conformation can be drawn, then the compound is *not* optically active.

(i) A **plane of symmetry** divides a molecule in such a way that points (atoms or groups of atoms) on the one side of the plane form mirror images of those on the other side. This test may be applied to both solid (tetrahedral) and plane-diagram formulæ, e.g., the plane-formula of the *meso*-form of *Cabd·Cabd* possesses a plane of symmetry; the other two, (+) and (-), do not

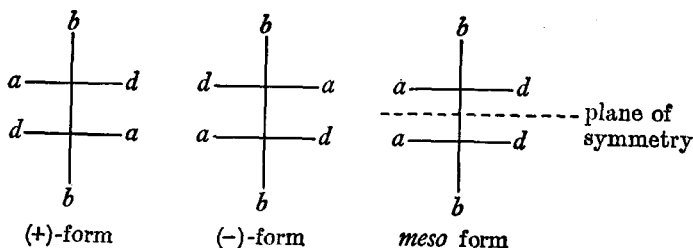

(ii) A **centre of symmetry** is a point from which lines, when drawn on one side and produced an equal distance on the other side, will meet exactly similar points in the molecule. This test can be satisfactorily applied only

to three-dimensional formulæ, particularly those of ring systems, *e.g.*, 2 : 4-dimethylcyclobutane-1 : 3-dicarboxylic acid (Fig. 14). The form shown possesses a centre of symmetry which is the centre of the ring. This form is therefore optically inactive.

Another example we shall consider here is that of dimethyldiketopiperazine; this molecule can exist in two geometrical isomeric forms, *cis* and

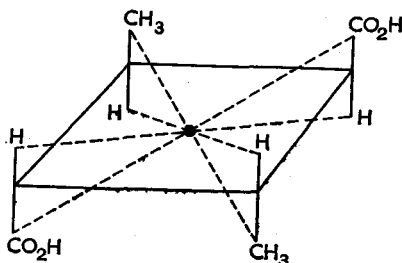
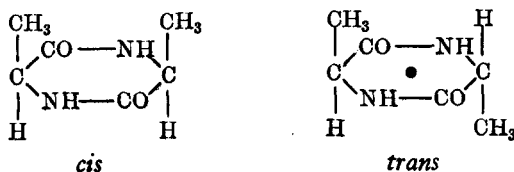

FIG. 2.14.

*trans* (see also §11. IV). The *cis*-isomer has no elements of symmetry and can therefore exist in two enantiomorphous forms; both are known. The *trans*-isomer has a centre of symmetry and is therefore optically inactive.



It is important to note that only *even-membered* rings can possibly possess a centre of symmetry.

(iii) **Alternating axis of symmetry.** A molecule possesses an  $n$ -fold alternating axis of symmetry if, when rotated through an angle of  $360^\circ/n$  about this axis and then followed by reflection in a plane perpendicular to the axis, the molecule is the same as it was in the starting position. Let us consider the molecule shown in Fig. 15 (a) [1 : 2 : 3 : 4-tetramethylcyclobutane]. This contains a four-fold alternating axis of symmetry. Rota-

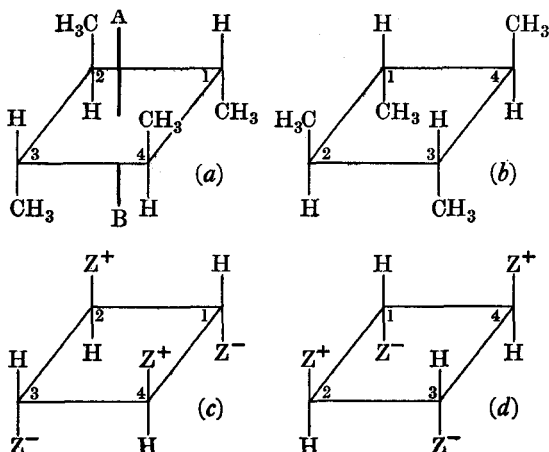
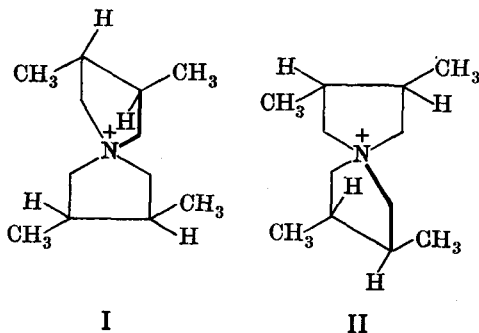

FIG. 2.15.



tion of (a) through  $90^\circ$  about axis AB which passes through the centre of the ring perpendicular to its plane gives (b), and reflection of (b) in the plane of the ring gives (a). It also happens that this molecule possesses two vertical planes of symmetry (through each diagonal of the ring), but if the methyl groups are replaced alternately by the asymmetric groups  $(+)\text{—CH}(\text{CH}_3)\cdot\text{C}_2\text{H}_5$  and  $(\text{—})\text{—CH}(\text{CH}_3)\cdot\text{C}_2\text{H}_5$ , represented by  $Z^+$  and  $Z^-$  respectively, the resulting molecule (Fig. 15c) now has no planes of symmetry. Nevertheless, this molecule is *not* optically active since it does possess a four-fold alternating axis of symmetry [reflection of (d) (which is produced by rotation of (c) through  $90^\circ$  about the vertical axis) in the plane of the ring gives (c); it should be remembered that the reflection of a (+)-form is the (—)-form].

The cyclobutane derivative (c) given above to illustrate the meaning of an alternating axis of symmetry is an imaginary molecule. No compound was known in which the optical inactivity was due to the existence of *only*



an alternating axis until McCasland and Proskow (1956) prepared such a molecule for the first time. This is a spiro-type of molecule (§7. V), *viz.*, 3 : 4 : 3' : 4'-tetramethylspiro-(1 : 1')-dipyrrolidinium *p*-toluenesulphonate, I (the *p*-toluenesulphonate ion has been omitted). This molecule is discussed in some detail in §2a. VI, but here we shall examine it for its alternating axis of symmetry. Molecule I is superimposable on its mirror image and hence is not optically active. It does not contain a plane or centre of symmetry, but it does contain a four-fold alternating axis of symmetry. To show the presence of this axis, if I rotated through  $90^\circ$  about the co-axis of both rings, II is obtained. Reflection of II through the central plane (*i.e.*, through the N atom) perpendicular to this axis gives a molecule identical and coincident with I.

McCasland *et al.* (1959) have now prepared a second compound, a pentaerythritol ester, whose optical inactivity can be attributed *only* to the presence of a four-fold alternating axis of symmetry (R = menthyl radical; see §16. VIII):

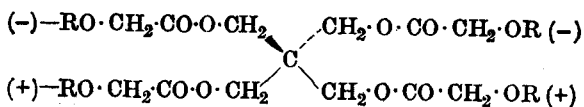

In practice one decides whether a molecule is symmetrical or not by looking only for a plane or centre of symmetry, since no *natural* compound has yet been found to have an alternating axis of symmetry. The presence of two or more asymmetric carbon atoms will definitely give rise to optical isomerism, but nevertheless *some* isomers may not be optically active because these *molecules as a whole* are not asymmetric (see §7d).

§7. **The number of isomers in optically active compounds.** The number of optical isomers that can theoretically be derived from a molecule containing one or more asymmetric carbon atoms is of fundamental importance in stereochemistry.

§7a. **Compounds containing one asymmetric carbon atom.** With the molecule *Cabde* only two optical isomers are possible, and these are related as object and mirror image, *i.e.*, there is one pair of enantiomorphs, *e.g.*, D- and L-lactic acid. If we examine an *equimolecular* mixture of dextro-rotatory and laevorotatory lactic acids, we shall find that the mixture is optically inactive. This is to be expected, since enantiomorphs have equal but opposite rotatory power. Such a mixture (of equimolecular amounts) is said to be **optically inactive by external compensation**, and is known as a **racemic modification** (see also §9). A compound which is optically inactive by external compensation is known as the **racemic compound** and is designated as *r*-, ( $\pm$ )- or DL-, *e.g.*, *r*-tartaric acid, ( $\pm$ )-limonene, DL-lactic acid.

Thus a compound containing *one* asymmetric carbon atom can exist in *three* forms: (+)-, (-) and ( $\pm$ ).

*Conversion of molecule  $Ca_b d$  into  $Cabde$ .* Let us consider as an example the bromination of propionic acid to give  $\alpha$ -bromopropionic acid.

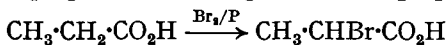

II and III (Fig. 16) are enantiomorphs, and since molecule I is symmetrical about its vertical axis, it can be anticipated from the theory of probability

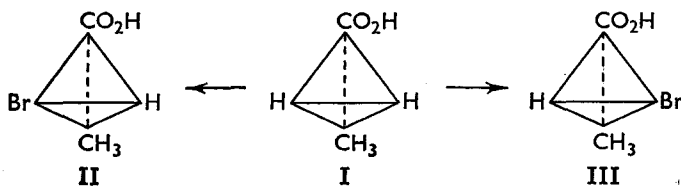

FIG. 2.16.

that either hydrogen atom should be replaced equally well to give ( $\pm$ )- $\alpha$ -bromopropionic acid. This actually does occur in practice.

§7b. **Compounds containing two different asymmetric carbon atoms.** When we examine the molecule *Cabd·Cabe*, *e.g.*,  $\alpha$ : $\beta$ -dibromobutyric acid,  $\text{CH}_3 \cdot \text{CHBr} \cdot \text{CHBr} \cdot \text{CO}_2\text{H}$ , we find that there are *four* possible spatial arrangements for this type of molecule (Fig. 17). I and II are enantiomorphs (the configurations of *both* asymmetric carbon are reversed),

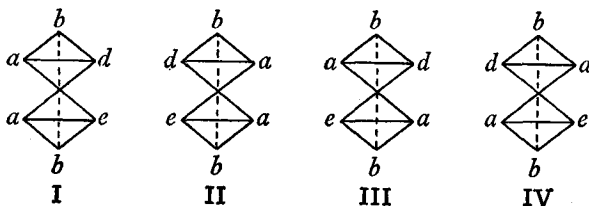

FIG. 2.17.

and an equimolecular mixture of them forms a racemic modification; similarly for III and IV. Thus there are six forms in all for a compound of the type *Cabd·Cabe*: two pairs of enantiomorphs and two racemic modifications.

I and III are not identical in configuration and are not mirror images

(the configuration of *one* of the two asymmetric carbon atoms is reversed); they are known as **diastereoisomers**, *i.e.*, they are optical isomers but not enantiomorphs (mirror images). Diastereoisomers differ in physical properties such as melting point, density, solubility, dielectric constant and specific rotation. Chemically they are similar, but their rates of reaction with other optically active compounds are different (*cf.* the properties of enantiomorphs, §2).

The plane-diagrams of molecules I-IV (Fig. 17) will be V-VIII, respectively, as shown. It should be remembered that groups joined to horizontal lines lie above the plane of the paper, and those joined to vertical lines lie below the plane of the paper (§5).

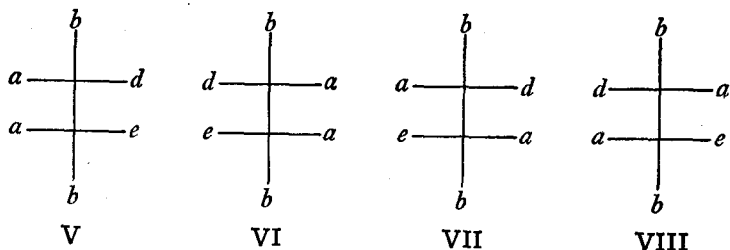

Instead of writing down all the possible configurations, the number of optical isomers for a compound of the type  $Cabd\cdot Cabc$  may be obtained by indicating the *configuration* of each asymmetric carbon atom by the symbol + or -, or by D or L; thus:

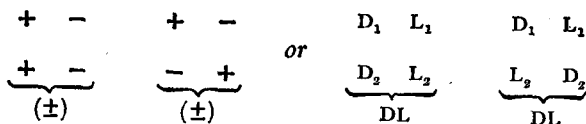

*Conversion of molecule  $Ca_2b\cdot Cabc$  into  $Cabd\cdot Cabc$ .* Let us consider the bromination of  $\beta$ -methylvaleric acid to give  $\alpha$ -bromo- $\beta$ -methylvaleric acid.

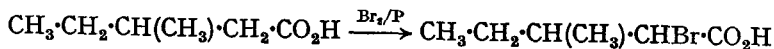

$\beta$ -Methylvaleric acid contains *one* asymmetric carbon atom, but the bromine derivative contains *two*. Let us first consider the case where the configuration of the asymmetric carbon atom in the starting material is  $D_1$  (IX). Bromination of this will produce molecules X and XI; these are diastereoisomers and are produced in *unequal* amounts. This is to be anticipated; the two  $\alpha$ -hydrogen atoms are not symmetrically placed with respect to the lower half of the molecule, and consequently different rates of substitution can be expected. In the same way, bromination of the starting material in which the configuration of the asymmetric carbon atom is  $L_1$  (XII) leads to the formation of a mixture of diastereoisomers (XIII and XIV) in unequal amounts. One can expect, however, that the amount of XIII produced from XII would be the same as that of X from IX since,

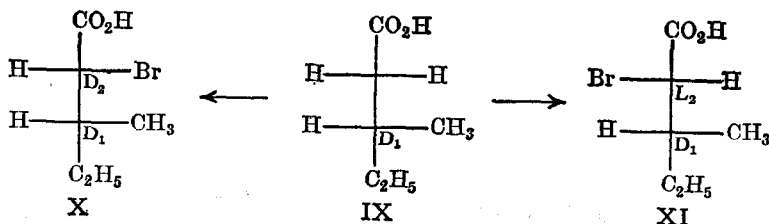

in both cases, the positions of the bromine atoms with respect to the methyl group are the same. Similarly, the amount of XIV from XII will be the same as that of XI from IX. Thus bromination of ( $\pm$ )- $\beta$ -methylvaleric

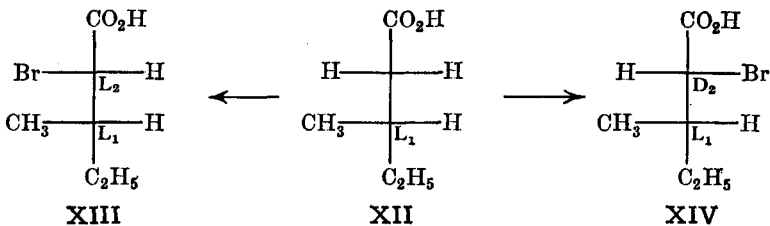

acid will result in a mixture of four bromo derivatives which will consist of two racemic modifications in unequal amounts, and the mixture will be optically inactive.

**§7c. Compounds containing three different asymmetric carbon atoms.** A molecule of this type is  $\text{Cab}d\cdot\text{Cab}\cdot\text{Cabe}$ , e.g., the pentoses, and the number of optical isomers possible is *eight* (four pairs of enantiomorphs):

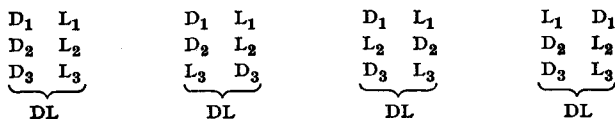

All the cases discussed so far are examples of a series of compounds which contain  $n$  *structurally distinct* carbon atoms, i.e., they belong to the series  $\text{Cab}d\cdot(\text{Cab})_{n-2}\cdot\text{Cabe}$ . In general, if there are  $n$  asymmetric carbon atoms in the molecule (of this series), then there will be  $2^n$  optically active forms and  $2^{n-1}$  resolvable forms (i.e.,  $2^{n-1}$  pairs of enantiomorphs). These formulæ also apply to *monocyclic* compounds containing  $n$  different asymmetric carbon atoms; they may or may not apply to *fused ring systems* since spatial factors may play a part in the possible existence of various configurations (see, e.g., camphor, §23a. VIII).

**§7d. Compounds of the type  $\text{Cab}d\cdot(\text{Cab})_x\cdot\text{Cab}d$ .** In compounds of this type the two *terminal* asymmetric carbon atoms are *similar*, and the number of optically active forms possible depends on whether  $x$  is *odd* or *even*.

#### (1) EVEN SERIES

(a)  $\text{Cab}d\cdot\text{Cab}d$ , e.g., tartaric acid. In a compound of this type the rotatory power of each asymmetric carbon atom is the same. Now let us consider the number of optical isomers possible.



In molecules I and II, the upper and lower halves reinforce each other; hence I, as a whole, has the dextro- and II, the lævo-configuration, i.e., I and II are optically active, and enantiomorphous. On the other hand, in III the two halves are in opposition, and so the molecule, *as a whole*, will not show optical activity. It is also obvious that III and IV are identical, i.e., there is only *one* optically inactive form of  $\text{Cab}d\cdot\text{Cab}d$ . Molecule III is said to be **optically inactive by internal compensation**. Molecule III

is known as the *meso*-form, and is a diastereoisomer of the pair of enantiomorphs I and II. The *meso*-form is also known as the *inactive* form and is represented as the *i*-form; **the *meso*-form cannot be resolved** (see also §10). Thus there are four forms possible for the molecule *Cabd·Cabd*: one pair of enantiomorphs, one racemic modification and one *meso*-(*i*-) form. These forms for tartaric acid are:

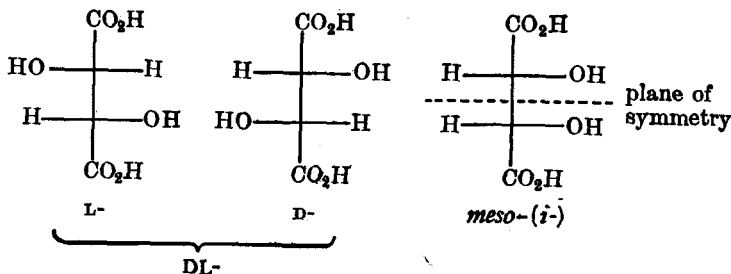

Inspection of these formulæ shows that the D- and L- forms do not possess any elements of symmetry; the *meso*-form, however, possesses a plane of symmetry.

(b) *Cabd·Cab·Cab·Cabd*, e.g., saccharic acid,

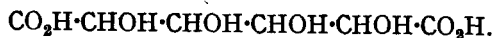

The rotatory powers of the two terminal asymmetric carbon atoms are the same, and so are those of the middle two (the rotatory powers of the latter are almost certainly different from those of the former; equality would be fortuitous). The possible optical isomers are as follows (V–XIV):

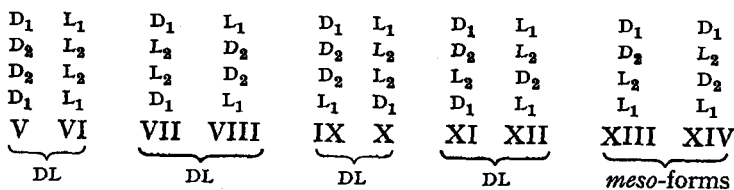

Molecules V and VI are optically active (enantiomorphous) and are not "internally compensated"; VII and VIII are optically active (enantiomorphous) and are not "internally compensated"; IX and X are optically active (enantiomorphous) but are "internally compensated at the ends"; XI and XII are optically active (enantiomorphous) but are "internally compensated in the middle"; XIII and XIV are *meso*-forms and are optically inactive by (complete) internal compensation. Thus there are eight optically active forms (four pairs of enantiomorphs), and two *meso*-forms.

In general, in the series of the type *Cabd·(Cab)<sub>n-2</sub>·Cabd*, if *n* is the number of asymmetric carbon atoms and *n* is *even*, then there will be  $2^{n-1}$  optically active forms, and  $2^{\frac{n-2}{2}}$  *meso*-forms.

### (II) ODD SERIES

(a) *Cabd·Cab·Cabd*, e.g., trihydroxyglutaric acid. If the two terminal asymmetric carbon atoms have the same configuration, then the central carbon atom has two identical groups joined to it and hence cannot be asymmetric. If the two terminal configurations are opposite, then the central carbon atom has apparently four different groups attached to it

(the two ends are mirror images and not superimposable). Thus the central carbon atom becomes asymmetric, but at the same time the two terminal atoms "compensate internally" to make the *molecule as a whole* symmetrical (there is now a plane of symmetry), and consequently the compound is not optically active. In this molecule the central carbon atom

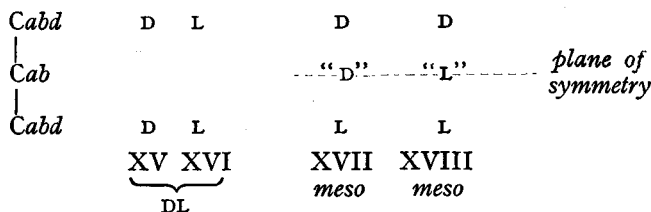

is said to be *pseudo-asymmetric*, and is designated "D" and "L" (or  $\oplus$  and  $\ominus$  if the + and - convention is used; §7b). There will, however, be *two meso-forms* since the pseudo-asymmetric carbon atom can have two different configurations (see XV-XVIII). Thus there are five forms in all: two optically active forms (enantiomorphs), one racemic modification, and two *meso-forms*. The following are the corresponding trihydroxyglutaric acids, all of which are known.

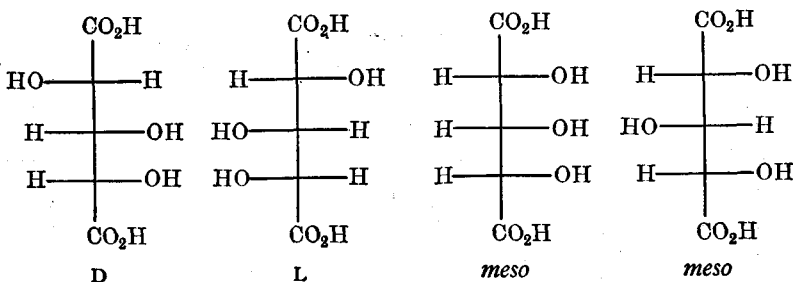

(b) *Cabd·Cab·Cab·Cab·Cabd*. In this molecule the central carbon atom is pseudo-asymmetric when the left-hand side of the molecule has the opposite configuration to that of the right-hand side; the central carbon atom is symmetrical when both sides have the same configuration. In all other cases the central carbon atom is asymmetric, the molecule now containing five asymmetric carbon atoms. The following table shows that there are *sixteen* optical isomers possible, of which twelve are optically active (six pairs of enantiomorphs), and four are *meso-forms*.

*Ends with opposite configurations*

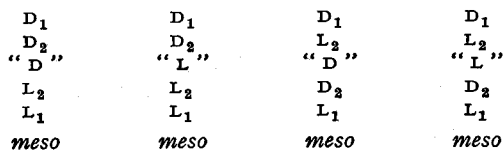

*Ends with the same configurations*

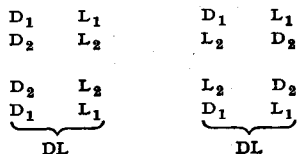

Molecule with five asymmetric carbon atoms

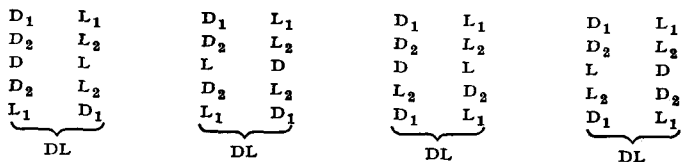

In general, in the series of the type  $Cabd \cdot (Cab)_{n-2} \cdot Cabd$ , if  $n$  is the number of "asymmetric" carbon atoms and  $n$  is *odd*, then there will be  $2^{n-1}$  optical isomers, of which  $2^{\frac{n-1}{2}}$  are *meso*-forms and the remainder optically active forms.

**§8. The racemic modification.** The racemic modification is an equimolecular mixture of a pair of enantiomorphs, and it may be prepared in several ways.

(i) Mixing of equimolecular proportions of enantiomorphs produces the racemic modification.

(ii) Synthesis of asymmetric compounds from symmetrical compounds always results in the formation of the racemic modification. This statement is true only if the reaction is carried out in the absence of other optically active compounds or circularly polarised light (see asymmetric synthesis, §7. III).

(iii) **Racemisation.** The process of converting an optically active compound into the racemic modification is known as racemisation. The (+)- and (-)-forms of most compounds are capable of racemisation under the influence of heat, light, or chemical reagents. Which agent is used depends on the nature of the compound, and at the same time the ease of racemisation also depends on the nature of the compound, *e.g.*,

(a) Some compounds racemise so easily that they cannot be isolated in the optically active forms.

(b) A number of compounds racemise spontaneously when isolated in optically active forms.

(c) The majority of compounds racemise with various degrees of ease under the influence of different reagents.

(d) A relatively small number of compounds cannot be racemised at all.

When a molecule contains two or more asymmetric carbon atoms and the configuration of only *one* of these is inverted by some reaction, the process is then called *epimerisation*.

Many theories have been proposed to explain racemisation, but owing to the diverse nature of the structures of the various optically active compounds, one cannot expect to find *one* theory which would explain the racemisation of *all types* of optically active compounds. Thus we find that a number of mechanisms have been suggested, each one explaining the racemisation of a particular type of compound.

A number of compounds which are easily racemisable are those in which the asymmetric carbon atom is joined to a hydrogen atom and a negative group. Since this type of compound can undergo tautomeric change, the mechanism proposed for this racemisation is one *via* enolisation. When the intermediate enol-form, which is symmetrical, reverts to the keto-form, it can do so equally well to produce the (+)- or (-)-forms, *i.e.*, the compound will racemise. Let us consider the case of keto-enol tautomerism: In the keto-form, I, the carbon joined to the hydrogen atom and the oxo group is asymmetric; in the enol-form, II, this carbon atom has lost its asymmetry. When the enol-form reverts to the keto-form, it can do so to produce the original keto molecule I, but owing to its symmetry, the

enol-form can produce equally well the keto-form III in which the configuration of the asymmetric carbon atom is opposite to that in I. Thus racemisation, according to this scheme, occurs *via* the enol-form, *e.g.*, (-)-lactic acid

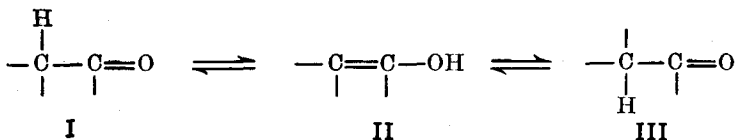

is racemised in aqueous sodium hydroxide, and this change may be formulated:

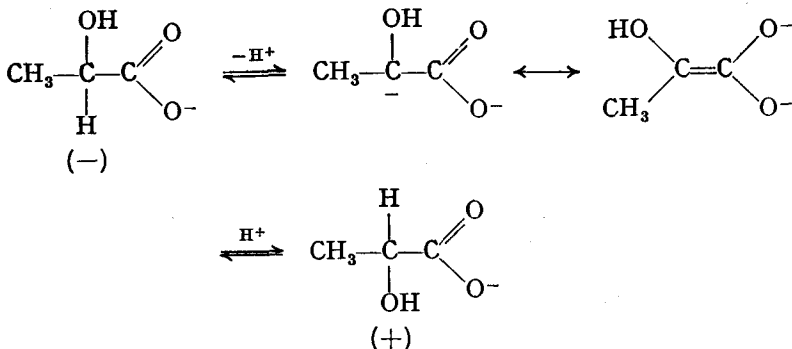

There is a great deal of evidence to support this tautomeric mechanism. When the hydrogen atom joined to the asymmetric carbon atom is replaced by some group that prevents tautomerism (enolisation) then racemisation is also prevented (at least under the same conditions as the original compound), *e.g.*, mandelic acid,  $\text{C}_6\text{H}_5\cdot\text{CHOH}\cdot\text{CO}_2\text{H}$ , is readily racemised by warming with aqueous sodium hydroxide. On the other hand, atrolactic acid,  $\text{C}_6\text{H}_5\cdot\text{C}(\text{CH}_3)(\text{OH})\cdot\text{CO}_2\text{H}$ , is not racemised under the same conditions; in this case keto-enol tautomerism is no longer possible.

Racemisation of compounds capable of exhibiting keto-enol tautomerism is catalysed by acids and bases. Since keto-enol tautomerism is also catalysed by acids and bases, then if racemisation proceeds *via* enolisation, the rates of racemisation and enolisation should be the same. This relationship has been established by means of kinetic studies, *e.g.*, Bartlett *et al.* (1935) found that the rate of acid-catalysed iodination of 2-butyl phenyl ketone was the same as that of racemisation in acid solution. This is in keeping with both reactions involving the rate-controlling formation of the enol (see Vol. I, Ch. X):

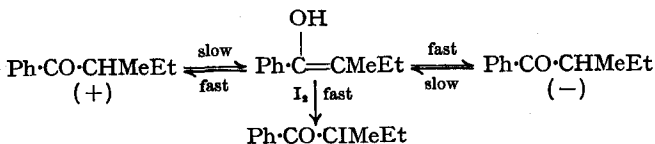

On the other hand, on the basis that the rate-determining step in base-catalysed enolisation and racemisation is the formation of the enolate ion, then the two processes will also occur at the same rate.

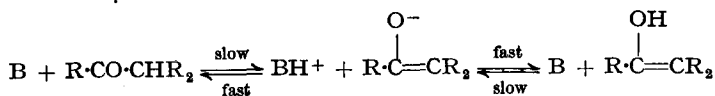





*et al.* (1936), however, found that pure  $\alpha$ -chloroethylbenzene in pure liquid sulphur dioxide does not conduct, but when there is conduction, then styrene and hydrogen chloride are present. These authors showed that under the conditions of purity, the addition of bromine leads to a quantitative yield of styrene dibromide.

Polanyi showed that the rate of racemisation of  $\alpha$ -chloroethylbenzene in liquid sulphur dioxide is unaffected by added chloride ions. Hughes and Ingold suggest that the rate of racemisation is accounted for by the rate of formation of hydrogen chloride; thus:

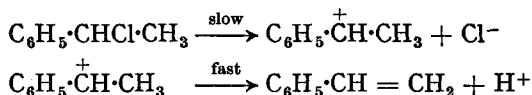

It is the recombination of the styrene with the hydrogen chloride that produces the racemised product; this may be written as follows

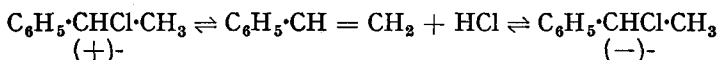

The racemisation of optically active hydrocarbons containing a tertiary hydrogen atom is very interesting. It has been shown that such hydrocarbons undergo hydrogen exchange when dissolved in concentrated sulphuric acid (Ingold *et al.*, 1936), and the mechanism is believed to occur *via* a carbonium ion (Burwell *et al.*, 1948).

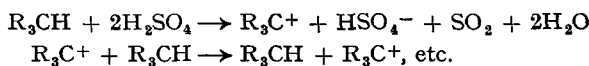

This reaction is very useful for racemising optically active hydrocarbons, *e.g.*, Burwell *et al.* (1948) racemised optically active 3-methylheptane in concentrated sulphuric acid (the carbonium ion is flat):

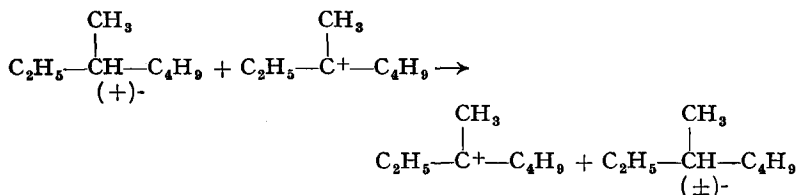

The racemisation of other types of optically active compounds is described later (see diphenyl compounds, §4. V; nitrogen compounds, §2a. VI; phosphorus compounds, §3b. VI; arsenic compounds, §4a. VI).

**§9. Properties of the racemic modification.** The racemic modification may exist in three different forms in the solid state.

(i) **Racemic mixture.** This is also known as a  $(\pm)$ -conglomerate, and is a mechanical mixture of two types of crystals, the (+)- and (-)-forms; there are two phases present. The physical properties of the racemic mixture are mainly the same as those of its constituent enantiomorphs. The most important difference is the m.p. (see §9a).

(ii) **Racemic compound.** This consists of a pair of enantiomorphs in combination as a molecular compound; only one solid phase is present. The physical properties of a racemic compound are different from those of the constituent enantiomorphs, but in solution racemic compounds dissociate into the (+)- and (-)-forms.

(iii) **Racemic solid solution.** This is also known as a *pseudo-racemic compound*, and is a solid solution (one phase system) formed by a pair of enantiomorphs crystallising together due to their being isomorphous. The

properties of the racemic solid solution are mainly the same as those of its constituent enantiomorphs; the m.p.s may differ (see §9a).

**§9a. Methods for determining the nature of a racemic modification.** One simple method of examination is to estimate the amounts of water of crystallisation in the enantiomorphs (only one need be examined) and in the racemic modification; if these are different, then the racemic modification is a racemic compound. Another simple method is to measure the densities of the enantiomorphs and the racemic modification; again, if these are different, the racemic modification is a racemic compound; e.g., tartaric acids.

	D-Tartaric acid	L-Tartaric acid	Racemic Tartaric acid
Melting point . . . . .	170°	170°	206°
Water of crystallisation .	None	None	1H <sub>2</sub> O
Density . . . . .	1.7598	1.7598	1.697
Solubility in H <sub>2</sub> O (at 20°)	139 g./100 ml.	139 g./100 ml.	20.6 g./100 ml.

There are, however, two main methods for determining the nature of a racemic modification: a study of the freezing-point curves and a study of the solubility curves (Roozeboom, 1899; Andriani, 1900).

**Freezing-point curves.** These are obtained by measuring the melting points of mixtures containing different amounts of the racemic modification and its corresponding enantiomorphs. Various types of curves are possible according to the nature of the racemic modification. In Fig. 18 (a) the

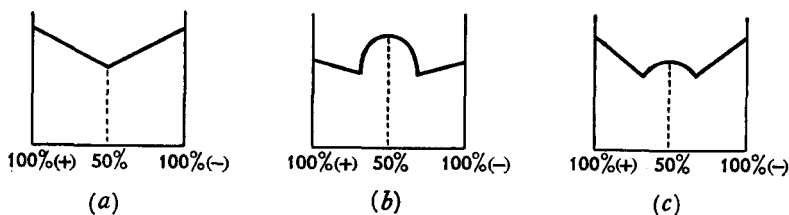

FIG. 2.18.

melting points of all mixtures are higher than that of the racemic modification alone. In this case the racemic modification is a racemic mixture (a eutectic mixture is formed at the point of 50 per cent. composition of each enantiomorph), and so addition of either enantiomorph to a racemic mixture *raises* the melting point of the latter; ( $\pm$ )-pinene is an example of this type. In Fig. 18 (b) and (c) the melting points of the mixtures are lower than the melting point of the racemic modification which, therefore, is a racemic compound. The melting point of the racemic compound may be above that of each enantiomorph (Fig. 18 b) or below (Fig. 18 c); in either case the melting point is *lowered* when the racemic compound is mixed with an enantiomorph; an example of Fig. 18 (b) is methyl tartrate, and one of Fig. 18 (c) is mandelic acid.

When the racemic modification is a racemic solid solution, three types of curves are possible (Fig. 19). In Fig. 19 (a) the freezing-point curve is a horizontal straight line, all possible compositions having the same melting point, e.g., (+)- and (-)-camphor. In Fig. 19 (b) the freezing-point curve shows a maximum, e.g., (+)- and (-)-carvoxime; and in Fig. 19 (c) the freezing-point curve shows a minimum, e.g., (+)- and (-)-isopentyl (iso-amyl) carbamate.

In a number of cases there is a transition temperature at which one form of the racemic modification changes into another form, e.g., ( $\pm$ )-camphor-oxime crystallises as the racemic solid solution above  $103^\circ$ , whereas below this temperature it is the racemic compound that is obtained [see also §10(i)].

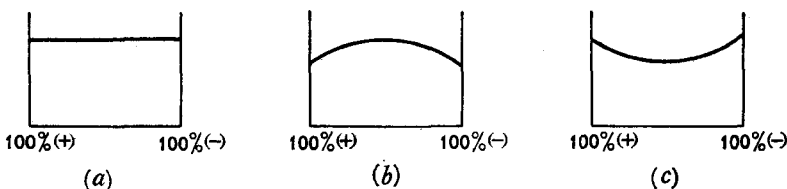
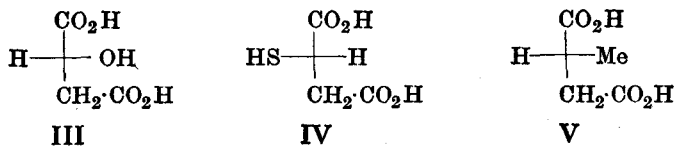

FIG. 2.19.

Fredga (1944) has introduced the study of quasi-racemic compounds as a means of correlating configurations (§5). Quasi-racemic compounds are equimolecular compounds that are formed from two optically active compounds which have *closely similar structures but opposite configurations*, e.g.,



I and II. The formation of a quasi-racemic compound is detected by studying the melting-point curves of the two components. The curves obtained are similar to those of the racemic modification shown in Fig. 18 (a), 18 (b) and 19 (a), but with the quasi-racemic compounds these curves are unsymmetrical (since the m.p.s of the components will be different). An unsymmetrical curve 18 (a) indicates a eutectic mixture, an unsymmetrical 19 (a) a solid solution and an unsymmetrical 18 (b) a quasi-racemic compound. Curves for quasi-racemic compounds are given only by compounds (containing one asymmetric carbon atom) which have closely similar structures but opposite configurations. On the other hand, curves of the other two types are given by compounds of *like* configuration (but some cases are known where the configurations have been opposite). Various examples of this method of correlating configurations have now been described, e.g., Fredga (1941) showed (partly by chemical methods and partly by using the quasi-racemate method) that (+)-malic acid (III) and (-)-mercaptosuccinic



acid (IV) had opposite configurations. He then showed (1942) that (-)-mercaptosuccinic acid formed a quasi-racemic compound with (+)-methylsuccinic acid (V). Therefore (IV) and (V) have *opposite* configurations and consequently (+)-malic acid and (+)-methylsuccinic acid have the *same* configuration (see also §§10(vi) and 23e. VIII).

Mislow *et al.* (1956) have applied the m.p. curves in a somewhat different manner. They worked with 3-mercapto-octanedioic acid (VI) and 3-methyl-octanedioic acid (VII). These authors found that compounds (-)-VI and (+)-VII gave solid solutions for all mixtures (unsymmetrical 19 a), whereas (+)-VI and (+)-VII gave a diagram with a single eutectic (unsymmetrical

18 a). These results indicate that (-)-VI and (+)-VII are of the same

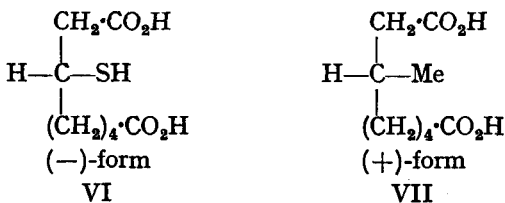

absolute configuration, whereas (+)-VI and (+)-VII are of opposite configurations.

**Solubility curves.** The interpretation of solubility curves is difficult, but in practice the following simple scheme based on solubility may be used. A small amount of one of the enantiomorphs is added to a *saturated* solution of the racemic modification, and the resulting solution is then examined in a polarimeter. If the solution exhibits a rotation, then the racemic modification is a compound, but if the solution has a zero rotation, then the racemic modification is a mixture or a solid solution. The reasons for this behaviour are as follows. If the racemic modification is a mixture or a solid solution, then the solution (in some solvent) is saturated with respect to each enantiomorph and consequently cannot dissolve any of the added enantiomorph. If, however, the racemic modification is a compound, then the solution (in a solvent) is saturated with respect to the compound form but not with respect to either enantiomorph; hence the latter will dissolve when added and thereby produce a rotation. It should be noted that this simple method does not permit a differentiation to be made between a racemic mixture and a racemic solid solution.

Infra-red spectroscopy is also being used to distinguish a racemic compound from a racemic mixture or a racemic solid solution. In the latter the spectra are identical, but are different in the former. These observations are also true for X-ray powder diagrams, and so X-ray analysis in the solid state may also be used.

**§10. Resolution of racemic modifications.** Resolution is the process whereby a racemic modification is separated into its two enantiomorphs. In practice the separation may be far from quantitative, and in some cases only one form may be obtained. A large variety of methods for resolution have now been developed, and the method used in a particular case depends largely on the chemical nature of the compound under consideration.

(i) **Mechanical separation.** This method is also known as **spontaneous resolution**, and was introduced by Pasteur (1848). It depends on the crystallisation of the two forms separately, which are then separated by hand. The method is applicable only to a few cases, and then only for racemic *mixtures* where the *crystal* forms of the enantiomorphs are themselves enantiomorphous (§2). Pasteur separated sodium ammonium racemate in this way. The transition temperature of sodium ammonium racemate is 28°; above this temperature the racemic compound crystallises out, and below this temperature the racemic mixture. Now Pasteur crystallised his sodium ammonium racemate from a concentrated solution at room temperature, which must have been below 28° since had the temperature been above this he would have obtained the racemic compound, which cannot be separated mechanically. Actually, Staedel (1878) failed to repeat Pasteur's separation since he worked at a temperature above 28°.

(ii) **Preferential crystallisation by inoculation.** A super-saturated solution of the racemic modification is treated with a crystal of one enantiomorph (or an isomorphous substance), whereupon this form is precipitated.

The resolution of glutamic acid by inoculation has been perfected for industrial use (Ogawa *et al.*, 1957; Oeda, 1961). Harada *et al.* (1962) have also resolved the copper complex of DL-aspartic acid by inoculation.

(iii) **Biochemical separation** (Pasteur, 1858). Certain bacteria and moulds, when they grow in a dilute solution of a racemic modification, destroy one enantiomorph more rapidly than the other, *e.g.*, *Penicillium glaucum* (a mould), when grown in a solution of ammonium racemate, attacks the D-form and leaves the L-.

This biochemical method of separation has some disadvantages:

(a) Dilute solutions must be used, and so the amounts obtained will be small.

(b) One form is always destroyed and the other form is not always obtained in 50 per cent. yield since some of this may also be destroyed.

(c) It is necessary to find a micro-organism which will attack only one of the enantiomorphs.

(iv) **Conversion into diastereoisomers** (Pasteur, 1858). This method, which is the best of all the methods of resolution, consists in converting the enantiomorphs of a racemic modification into diastereoisomers (§7b); the racemic modification is treated with an optically active substance and the diastereoisomers thereby produced are separated by fractional crystallisation. Thus racemic acids may be separated by optically active bases, and *vice versa*, *e.g.*,

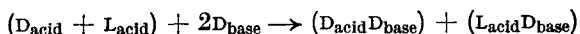

These two diastereoisomers may then be separated by fractional crystallisation and the acids (enantiomorphs) regenerated by hydrolysis with inorganic acids or with alkalis. In practice it is usually easy to obtain the less-soluble isomer in a pure state, but it may be very difficult to obtain the more-soluble isomer. In a number of cases this second (more-soluble) isomer may be obtained by preparing it in the form of *another* diastereoisomer which is less soluble than that of its enantiomorph.

Resolution by means of diastereoisomer formation may be used for a variety of compounds, *e.g.*,

(a) **Acids.** The optically active bases used are mainly alkaloids: brucine, quinine, strychnine, cinchonine, cinchonidine and morphine. Recently, optically active benzimidazoles (§3a. XII) have been used (Hudson *et al.*, 1939).

(b) **Bases.** Many optically active acids have been used, *e.g.*, tartaric acid, camphor- $\beta$ -sulphonic acid and particularly  $\alpha$ -bromocamphor- $\pi$ -sulphonic acid (see §23a. VIII).

(c) **Alcohols.** These are converted into the acid ester derivative using either succinic or phthalic anhydride (Pickard and Kenyon, 1912). The acid ester, consisting of equimolecular amounts of the (+)- and (-)-forms,

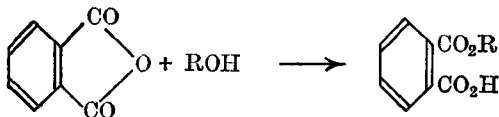

may now be resolved as for acids. Racemic alcohols may also be resolved by diastereoisomer formation with optically active acyl chlorides (to form esters) or with optically active *isocyanates* (to form urethans):

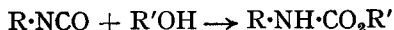
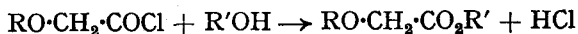

In these equations R is the (-)-menthyl radical (§16. VIII); recently

*N*-(−)-menthyl-*p*-sulphamylbenzoyl chloride, I, has been used (Mills *et al.*, 1950).

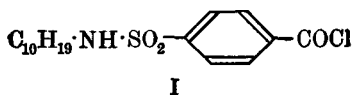

(*d*) *Aldehydes and Ketones*. These have been resolved by means of optically active hydrazines, *e.g.*, (−)-menthylhydrazine. Sugars have been resolved with (+)-isopentane-thiol (*cf.* §1. VII). Nerdel *et al.* (1952) have resolved oxo compounds with *D*-tartramide acid hydrazide,



this forms diastereoisomeric tartramazones.

(*e*) *Amino-compounds*. These may be resolved by conversion into diastereoisomeric anils by means of optically active aldehydes.  $\alpha$ -Amino-acids have been resolved by preparing the acyl derivative with an optically active acyl chloride, *e.g.*, (−)-menthoxyacetyl chloride (*cf. alcohols*). Another method of resolving *DL*-amino-acids is asymmetric enzymic synthesis (§7. III). The racemic amino-acid is converted into the acyl derivative which is then allowed to react with aniline in the presence of the enzyme papain at the proper *pH* (Albertson, 1951). Under these conditions only the *L*-amino-acid derivative reacts to form an insoluble anilide; the *D*-acid does not react but remains in the solution.

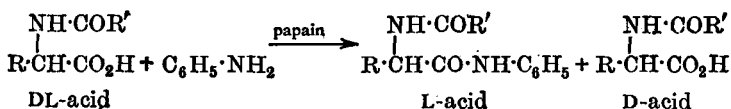

Amino-acids have also been resolved by other means (see §4. XIII).

**Asymmetric transformation.** Resolution of racemic modifications by means of salt formation (the diastereoisomers are salts; *cf. acids and bases*) may be complicated by the phenomenon of *asymmetric transformation*. This phenomenon is exhibited by compounds that are optically unstable, *i.e.*, the enantiomorphs are readily interconvertible

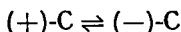

There are two types of asymmetric transformation, first order and second order. These were originally defined by Kuhn (1932), but were later re-defined by Jamison and Turner (1942).

Suppose we have an optically stable (+)-base (one equivalent) dissolved in some solvent, and this is then treated with one equivalent of an optically unstable ( $\pm$ )-acid. At the moment of mixing, the solution will contain equal amounts of [(+)-Base·(+)-Acid] and [(+)-Base·(−)-Acid]; but since the acid is optically unstable, the two diastereoisomers will be present in unequal amounts when equilibrium is attained.

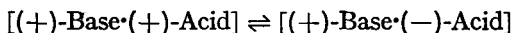

According to Jamison and Turner, first-order asymmetric transformation is the establishment of equilibrium *in solution* between the two diastereoisomers which must have a *real* existence. In second-order asymmetric transformation it is necessary that one salt should crystallise from solution; the two diastereoisomers need not have a real existence in solution. In second-order asymmetric transformation it is possible to get a complete conversion of the acid into the form that crystallises; the form may be the (+)- or (−)-, and which one it is depends on the nature of the base and the solvent.

Many examples of first- and second-order asymmetric transformation are known, and a large number of these compounds are those which owe their asymmetry to restricted rotation about a single bond (see Ch. V), *e.g.*, Mills and Elliott (1928) tried to resolve *N*-benzenesulphonyl-8-nitro-1-naphthylglycine, II, by means of the brucine salt. These authors found that either

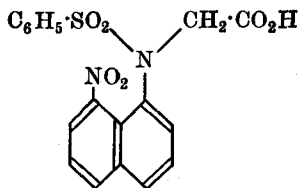

II

diastereoisomer could be obtained in approximately 100 per cent. yield by crystallisation from methanol and acetone, respectively. Another example of second-order asymmetric transformation is hydrocarbostyryl-3-carboxylic acid. This compound contains an asymmetric carbon atom, and Leuchs

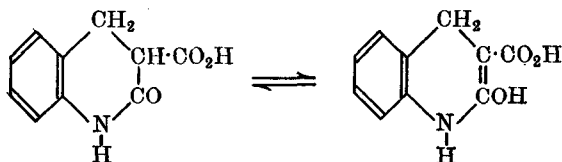

(1921), attempting to resolve it with quinidine, isolated approximately 90 per cent. of the (+)-form. Optical instability in this case is due to keto-enol tautomerism (*cf.* §8).

A very interesting example of second-order asymmetric transformation is 2-acetomethylamido-4':5-dimethylphenylsulphone, III. When this com-

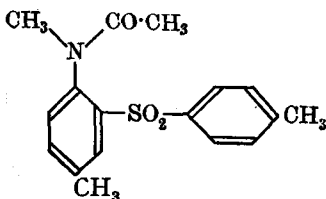

III

pound was crystallised from a supersaturated solution in ethyl (+)-tartrate, the crystals obtained had a rotation of  $+0.2^\circ$ ; evaporation of the mother liquor gave crystals with a rotation of  $-0.15^\circ$  (Buchanan *et al.*, 1950).

(v) Another method of resolution that has been tried is the conversion of the enantiomorphs into *volatile* diastereoisomers, which are then separated by fractional distillation. So far, the method does not appear to be very successful, only a partial resolution being the result, *e.g.*, Bailey and Hass (1941) converted ( $\pm$ )-pentan-2-ol into its diastereoisomers with L(+)-lactic acid, and then partially separated them by fractional distillation.

(vi) **Selective adsorption.** Optically active substances may be selectively adsorbed by some optically active adsorbent, *e.g.*, Henderson and Rule (1939) partially resolved *p*-phenylenebisiminocamphor on lactose as adsorbent; Bradley and Easty (1951) have found that wool and casein selectively adsorb (+)-mandelic acid from an aqueous solution of ( $\pm$ )-man-



delic acid. A particularly important case of resolution by chromatography is that of Tröger's base (see §2c. VI).

Jamison and Turner (1942) have carried out a chromatographic separation without using an optically active adsorbent; they partially resolved the diastereoisomers of (–)-menthyl (±)-mandelate by preferential adsorption on alumina. It is also interesting to note that the resolution of a racemic acid by salt formation with an optically active base is made more effective by the application of chromatography.

Resolution has also been carried out by vapour-phase chromatography, *e.g.*, *s*-butanol and *s*-butyl bromide have been separated into two overlapping fractions using a column of starch or ethyl tartrate as the stationary phase (Karagounis *et al.*, 1959). Casanova *et al.* (1961) have resolved (±)-camphor by gas chromatography.

Beckett *et al.* (1957) have introduced a novel method for correlating and determining configurations (*cf.* §9). These authors have prepared "stereo-selective adsorbents". These are adsorbents prepared in the presence of a suitable reference compound of known configuration, *e.g.*, silica gel in the presence of quinine. Such an adsorbent exhibits higher adsorptive power for isomers related to the reference compound than for their stereoisomers, provided that their structures are not too dissimilar from that of the reference compound. Thus silica gel prepared in the presence of quinine adsorbs quinine more readily than its stereoisomer quinidine; cinchonidine (configurationally related to quinine) is adsorbed more readily than its stereoisomer cinchonine (configurationally related to quinidine).

(vii) **Kinetic method of resolution.** Marckwald and McKenzie (1899) found that (–)-menthol reacts more slowly with (–)-mandelic acid than with the (+)-acid. Hence, if insufficient (–)-menthol is used to completely esterify (±)-mandelic acid, the resulting mixture of diastereoisomers will contain more (–)-menthyl (+)-mandelate than (–)-menthyl (–)-mandelate. Consequently there will be more (–)-mandelic acid than (+)-mandelic acid in the *unchanged* acid, *i.e.*, a partial resolution of (±)-mandelic acid has been effected (see also §5b. VI).

(viii) Ferreira (1953) has partially resolved (±)-narcotine and (±)-laudanone (1–2.5 per cent. resolution) *without* the use of optically active reagents. He dissolved the racemic alkaloid in hydrochloric acid and then *slowly* added pyridine; the alkaloid was precipitated, and it was found to be optically active. The explanation offered for this partial resolution is as follows (Ferreira). When a crystalline racemic substance is precipitated from solution, a crystallisation nucleus is first developed. Since this nucleus contains a relatively small number of molecules, there is more than an even chance that it will contain an excess of one enantiomorph or other. If it be assumed that the forces acting on the growth of crystals are the same kind as those responsible for adsorption [*cf.* (vi)], the nucleus will grow preferentially, collecting one enantiomorph rather than the other. Crystallisation, when carried out in the usual manner, results in the formation of crystals containing more or less equivalent numbers of both enantiomorphs.

Channel complex formation has also been used to resolve racemic modifications (see Vol. I). This also offers a means of carrying out a resolution without asymmetric reagents, *e.g.*, Schlenk (1952) added (±)-2-chloro-octane to a solution of urea and obtained, on fractional crystallisation, the two urea inclusion complexes urea/(+)-2-chloro-octane and urea/(–)-2-chloro-octane.

Baker *et al.* (1952) have prepared tri-*o*-thymotide, and found that it formed clathrates with ethanol, *n*-hexane, etc. Powell *et al.* (1952) have shown that tri-*o*-thymotide crystallises as a racemate, but that resolution takes place when it forms clathrates with *n*-hexane, benzene or chloroform. By means of seeding and slow growth of a single crystal, it is possible to obtain the

(+)- or (-)-form depending on the nature of the seed. Furthermore, crystallisation of tri-*o*-thymotide (*dl*) from a solvent which is itself a racemic modification (*d'l'*) and which forms a clathrate, produces crystals of the

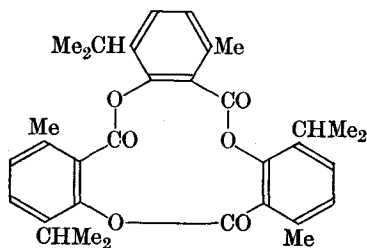

tri-*o*-thymotide

types *dd'* and *ll'*. Thus such (solvent) racemic modifications can be resolved, e.g., *sec.*-butyl bromide has been resolved in this way.

§11. The cause of optical activity. Two important points that arise from the property of optical activity are: What types of structure give rise to optical activity, and why? Fresnel (1822) suggested the following explanation for optical activity in *crystalline* substances such as quartz, basing it on the principle that any simple harmonic motion along a straight line may be considered as the resultant of two opposite circular motions. Fresnel assumed that plane-polarised light, on entering a substance in a direction parallel to its optic axis, is resolved into two beams of circularly polarised light, one right-handed (dextro-) and the other left-handed (lævo-), and both having the same frequency. If these two component beams travel through the medium with the same velocity, then the issuing resultant beam suffers no rotation of its plane of polarisation (Fig. 20 *a*). If the velocity of the lævocircularly polarised component is, for some reason, retarded, then the resultant beam is rotated through some angle to the right (in the direction of the faster circular component; Fig. 20 *b*). Similarly, the resultant beam is rotated to the left if the dextrocircularly polarised component is retarded (Fig. 20 *c*). Fresnel tested this theory by passing

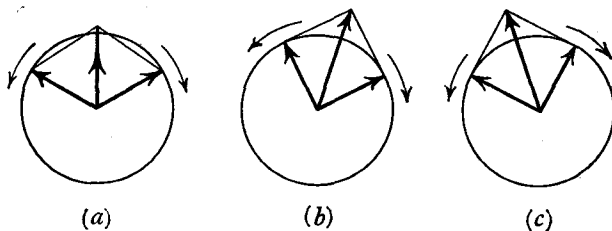

FIG. 2.20.

a beam of plane-polarised light through a series of prisms composed alternately of dextro- and lævorotatory quartz (Fig. 21). Two separate beams emerged, each circularly polarised in opposite senses; this is an agreement with Fresnel's explanation. Fresnel suggested that when plane-polarised light passed through an optically active crystalline substance, the plane of polarisation was rotated because of the retardation of one of the circular components. Stated in another way, Fresnel's theory requires that the refractive indices for dextro- and lævocircularly polarised light should be different for optically active substances. It has been shown mathematically that only a very small difference between these refractive indices gives rise

to fairly large rotations, and that if the refractive index for the lævocircularly polarised light is greater than that for the dextro component, the substance will be dextrorotatory. The difficulty of Fresnel's theory is that it does not explain *why* the two circular components should travel with different velocities. It is interesting to note, however, that Fresnel (1824) suggested that the optical activity of quartz is due to the structure being built up in right- and left-handed spirals (*cf.* §2).

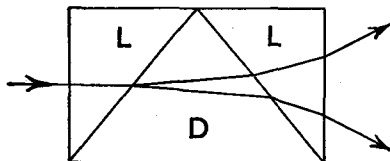

FIG. 2.21.

Now let us consider the problem of optical activity of substances *in solution*. In this case the optical activity is due to the *molecules* themselves, and not to crystalline structure (see also §2). Any *crystal* which has a plane of symmetry *but not a centre of symmetry* (§6) rotates the plane of polarisation, the rotation varying with the direction in which the light travels through the crystal. No rotation occurs if the direction of the light is perpendicular or parallel to the plane of symmetry. If we assume that molecules in a solution (or in a pure liquid) behave as individual crystals, then any molecule having a plane but not a centre of symmetry will also rotate the plane of polarisation, provided that the light travels through the molecule in any direction other than perpendicular (or parallel) to the plane of symmetry. Let us consider the molecule  $Ca_2bd$  (Fig. 22). This has a plane of symmetry, and so molecule I and its mirror image II are superimposable. Now let us suppose that the direction of plane-polarised

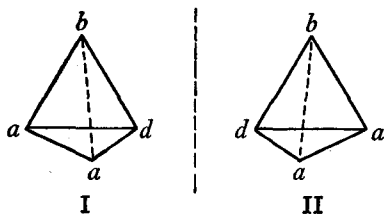

FIG. 2.22.

light passing through molecule I makes an angle  $\theta^\circ$  with the plane of symmetry, and that the resultant rotation is  $+\alpha^\circ$ . Then if the direction of the light through molecule II also makes an angle  $\theta^\circ$  with the plane of symmetry, the resultant rotation will be  $-\alpha^\circ$ . Thus the *total* rotation produced by molecules I and II is *zero*. In a solution of compound  $Ca_2bd$ , there will be an *infinite number of molecules in random orientation*. Statistically one can expect to find that whatever the angle  $\theta$  is for molecule I, there will always be molecule II also being traversed by light entering at angle  $\theta$ . **Thus, although each individual molecule rotates the plane of polarisation by an amount depending on the value of  $\theta$ , the statistical sum of the contributions of the individual molecules will be zero.**

When a molecule is not superimposable on its mirror image, then if only one enantiomorph is present in the solution, the rotation produced by each individual molecule will (presumably) depend on the angle of incidence (with respect to any face), but there will be no compensating molecules (*i.e.*, mirror image molecules) present. Hence, in this case, there will be a net

rotation that is *not* zero, the actual value being the statistical sum of the individual contributions (which are all in the *same* direction). Thus, if we consider the behaviour of a compound in a solution (or as a pure liquid) *as a whole*, then the observed experimental results are always in accord with the statement that **if the molecular structure of the compound is asymmetric, that compound will be optically active** (§2). Any compound composed of molecules possessing a plane but not a centre of symmetry is, considered *as a whole*, optically inactive, the net zero rotation being the result of "external compensation" (*cf.* §7a). This point is of great interest in connection with flexible molecules (§4). Let us consider *mesotartaric acid*, a compound that is optically inactive by internal compensation (§7b). X-ray studies (Stern *et al.*, 1950) have shown that the staggered form of the molecule is the favoured one (Fig. 23 a). This has a centre of symmetry, and so molecules in this configuration are *individually*

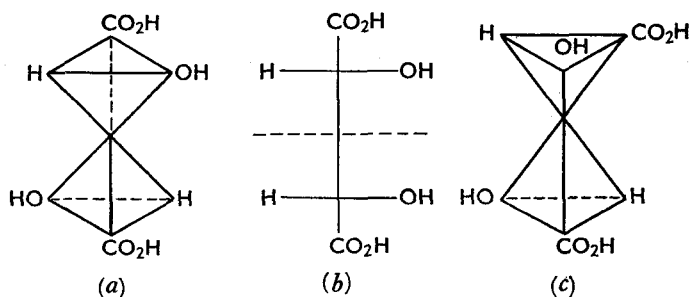

FIG. 2.23.

optically inactive. On the other hand, *mesotartaric acid* is usually represented by the plane-diagram formula in Fig. 23 (b). This corresponds to the eclipsed form, and has a plane of symmetry. In this conformation the *individual* molecules are optically active except when the direction of the light is perpendicular (or parallel) to the plane of symmetry; the net rotation is zero by "external compensation". It is possible, however, for the molecule to assume, at least theoretically, many conformations which have no elements of symmetry, *e.g.*, Fig. 23 (c). All molecules in this conformation will contribute *in the same direction* to the net rotation. If the *total number* of molecules present were in this conformation, then *mesotartaric acid* would have some definite rotation. On the theory of probability, however, for every molecule taking up the conformation in Fig. 23 (c), there will also be present its mirror image molecule, thereby giving a net *zero* rotation due to "external compensation". As we have seen, *mesotartaric acid* is optically inactive (as shown experimentally), and by common usage the inactivity is said to be due to *internal compensation* (§7b).

## READING REFERENCES

- Gilman, *Advanced Organic Chemistry*, Wiley (1943, 2nd ed.). Vol. I. Ch. 4. Stereoisomerism.  
 Wheland, *Advanced Organic Chemistry*, Wiley (1960, 3rd ed.).  
 Partington, *An Advanced Treatise on Physical Chemistry*, Longmans, Green. Vol. IV (1953), p. 290 *et seq.* Optical Activity.  
 Eliel, *Stereochemistry of Carbon Compounds*, McGraw-Hill (1962).  
 Frankland, Pasteur Memorial Lecture, *J.C.S.*, 1897, 71, 683.  
 Walker, van't Hoff Memorial Lecture, *J.C.S.*, 1913, 103, 1127.  
 Pope, Obituary Notice of Le Bel, *J.C.S.*, 1930, 2789.  
 Pasteur, *Researches on the Molecular Asymmetry of Natural Organic Products*, Alembic Club Reprints—No. 14.

- Mann and Pope, Dissymmetry and Asymmetry of Molecular Configuration, *Chem. and Ind.*, **1925**, 833.
- Barker and Marsh, Optical Activity and Enantiomorphism of Molecular and Crystal Structure, *J.C.S.*, **1913**, **103**, 837.
- van't Hoff, *Chemistry in Space*, Oxford Press (1891; translated by Marsh).
- Bijvoet, Structure of Optically Active Compounds in the Solid State, *Nature*, **1954**, **173**, 888.
- Rosanoff, On Fischer's Classification of Stereoisomers, *J. Amer. Chem. Soc.*, **1906**, **28**, 114.
- Cahn, Ingold and Prelog, The Specification of Asymmetric Configuration in Organic Chemistry, *Experientia*, **1956**, **12**, 81.
- Turner and Harris, Asymmetric Transformation and Asymmetric Induction, *Quart. Reviews (Chem. Soc.)*, **1948**, **1**, 299.
- Fredga, Steric Correlations by Quasi-Racemate Method, *Tetrahedron*, **1960**, **8**, 126.
- Bent, Aspects of Isomerism and Mesomerism, *J. Chem. Educ.*, **1953**, **30**, 220, 284, 328.
- Kauzmann, Walter and Eyring, Theories of Optical Rotatory Power, *Chem. Reviews*, **1940**, **26**, 339.
- Jones and Eyring, A Model for Optical Rotation, *J. Chem. Educ.*, **1961**, **38**, 601.
- Hargreaves, Optical Rotatory Dispersion: Its Nature and Origin, *Nature*, **1962**, **195**, 560.
- Hudson, Emil Fischer's Stereo-Formulas, *Advances in Carbohydrate Chemistry*, Academic Press. Vol. 3 (1948). Ch. 1.
- Barton and Cookson, The Principles of Conformational Analysis, *Quart. Reviews (Chem. Soc.)*, **1956**, **10**, 44.
- Newman (Ed.), *Steric Effects in Organic Chemistry*, Wiley (1956). Ch. I. Conformational Analysis.
- Newman, A Notation for the Study of Certain Stereochemical Problems, *J. Chem. Educ.*, **1955**, **32**, 344.
- Eliel, Conformational Analysis in Mobile Systems, *J. Chem. Educ.*, **1960**, **37**, 126.
- Mizushima, *Structure of Molecules and Internal Rotation*, Academic Press (1954).
- Klyne (Ed.), *Progress in Stereochemistry*, Butterworth. Vol. I (1954); Vol. II (1958).
- Cram, Recent Advances in Stereochemistry, *J. Chem. Educ.*, **1960**, **37**, 317.
- Brewster, A Useful Model of Optical Activity, *J. Amer. Chem. Soc.*, **1959**, **81**, 5475.



carbonium ions are stable in dilute solutions of sulphuric acid. They have also found that the spectroscopic examination of solutions of *t*-butanol and *isobutene* in sulphuric acid shows a single measurable ultraviolet band in both solutions. This band appears slowly according to the first-order rate law for *t*-butanol, but very rapidly for the olefin; the solutions are stable (and reproducible). The authors conclude that there are trimethylcarbonium ions,  $\text{CMe}_3^+$ , in solution, and that it is probable that this ion is planar. Symons *et al.* (1961) have also obtained evidence, from ultraviolet studies, for the existence of the allyl carbonium ion in sulphuric acid; they examined solutions of allyl alcohol, chloride, bromide, etc., in sulphuric acid.

On the other hand, triarylcation ions have been obtained as salts, *e.g.*, triphenylmethyl perchlorate,  $\text{Ph}_3\text{C}^+\text{ClO}_4^-$ , and fluoroborate,  $\text{Ph}_3\text{C}^+\text{BF}_4^-$  (Dauben jun. *et al.*, 1960).

§2. Any factor that affects the energy of activation ( $E$ ) of a given type of reaction will affect the rate and/or the mechanism. Attempts have been made to calculate  $E$  in terms of bond strengths, the steric factor, heats of solutions of ions, etc., but apparently the results are conflicting. The following discussion is therefore largely qualitative, and because of this, one cannot be sure which are the predominant factors in deciding the energy of activation. We shall discuss, for the hydrolysis of alkyl halides, the influence of the following factors: The nature of R (polar and steric effects); the nature of X and Y; and the nature of the solvent.

§2a. The nature of R. (a) *Polar effects.* Let us consider the series EtX, *i*-PrX, and *t*-BuX. Since the methyl group has a +I effect, the larger the number of methyl groups on the carbon atom of the C—X group, the greater will be the electron density on this carbon atom. This may be represented qualitatively as follows:

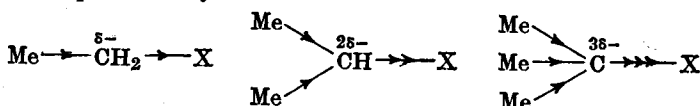

This increasing negative charge on the central carbon atom increasingly opposes attack at this carbon by a negatively charged nucleophilic reagent; it also opposes, to a lesser extent, attack by a neutral nucleophilic reagent since this still donates an electron pair. Thus the formation of the transition state for the  $\text{S}_{\text{N}}2$  mechanism is opposed more and more as the charge on the central carbon atom increases. (There is also an increasing steric effect operating; this is dealt with in §2b.) The anticipated result, therefore, is that as the number of methyl groups increases on the central carbon atom, the  $\text{S}_{\text{N}}2$  mechanism is made more difficult in passing from EtX to *t*-BuX. On the other hand, since the  $\text{S}_{\text{N}}1$  mechanism involves ionisation of RX (in the rate-determining step), any factor that makes easier the ionisation of the molecule will therefore facilitate the  $\text{S}_{\text{N}}1$  mechanism. The anticipated result, therefore, is that the greater the negative charge on the central carbon atom, the easier will be the ionisation of RX since X is displaced with its covalent electron pair; thus the tendency for the  $\text{S}_{\text{N}}1$  mechanism should increase from EtX to *t*-BuX.

These predicted results have been verified experimentally. Hughes, Ingold *et al.* (1935–1940) examined the rates of hydrolysis of alkyl bromides in alkaline aqueous ethanol at 55°:

	MeBr	EtBr	<i>i</i> -PrBr	<i>t</i> -BuBr
2nd-order rate const. $\times 10^5$	2140	170	4.7	
1st-order rate const. $\times 10^5$			0.24	1010

It can be seen from these results that MeBr and EtBr undergo hydrolysis by the  $S_N2$  mechanism, *i*-PrBr by both  $S_N2$  and  $S_N1$ , and *t*-BuBr by  $S_N1$  only. Thus, as the polar effects in the alkyl group produce an increasing electron density on the central carbon atom, the rate of the  $S_N2$  mechanism decreases and a point is reached where the mechanism changes over to  $S_N1$ . With *i*-PrBr both  $S_N2$  and  $S_N1$  mechanisms operate, and the rate of the  $S_N2$  mechanism is much less than that of the  $S_N1$  mechanism for EtBr. With *t*-BuBr the electron density on the central carbon atom is so great that the  $S_N2$  mechanism is completely inhibited; a very rapid hydrolysis occurs by the  $S_N1$  mechanism only. Since the mechanism is  $S_N1$ , it therefore means that the hydroxide ion does not enter into the rate-determining step of the hydrolysis (§1). This has been proved as follows. The hydrolysis of *t*-BuBr was carried out in an alkaline solution containing less than the equivalent amount of hydroxide ion (compared with the alkyl bromide). Thus, although the solution was originally alkaline, as the hydrolysis proceeds, the solution becomes neutral and finally acid; nevertheless, the rate constant of the hydrolysis remained unchanged.

As pointed out above, there are reactions which occur under intermediate conditions, *i.e.*, at the border-line between the extreme  $S_N1$  and  $S_N2$  mechanisms. Some authors believe that in this border-line region there is only *one* mechanism operating, *e.g.*, Prevost (1958) has postulated, on theoretical grounds, the existence of a more universal "mesomechanism". There is, however, much experimental work in favour of concurrent  $S_N1$  and  $S_N2$  mechanisms operating. Gold (1956) has described evidence for this view, and more recently Swart *et al.* (1961) have shown that the exchange reaction between diphenylmethyl chloride and radiochlorine (as  $LiCl^*$ ) in dimethylformamide occurs by a simultaneous  $S_N1$ - $S_N2$  mechanism.

The actual position where the mechanism changes over from  $S_N2$  to  $S_N1$  in a graded series, *e.g.*, in the one already described, is not fixed but depends on other factors such as the concentration and nature of the nucleophilic reagent, and on the nature of the solvent (see below).

Experimental work has shown that higher *n*-alkyl groups behave similarly to ethyl. For a given set of conditions, the kinetic order is the same, but the rates tend to decrease as the number of carbon atoms increases, *e.g.*, Hughes, Ingold *et al.* (1946, 1948) showed that the reactions between primary alkyl bromides and ethoxide ion in dry ethanol are all  $S_N2$ , and their relative rates (at 55°) are Me, 17.6; Et, 1.00; *n*-Pr, 0.31; *n*-Bu, 0.23; *n*-pentyl, 0.21. Similar results were obtained for secondary alkyl groups. In these cases the mechanisms were both  $S_N2$  and  $S_N1$ , but the rates for one or other order were reasonably close, *e.g.*, for the second-order reactions of secondary bromides with ethoxide ion in dry ethanol at 25°, Hughes, Ingold *et al.* (1936- ) found that the relative rates were: *i*-Pr, 1.00; 2-*n*-Bu, 1.29; 2-*n*-pentyl, 1.16; 3-*n*-pentyl, 0.93. These authors also showed that higher tertiary alkyl groups behaved similarly to *t*-Bu, all showing a strong tendency to react by the  $S_N1$  mechanism.

When hydrogen atoms in methyl chloride are replaced by phenyl groups, the mechanism of the hydrolysis may be changed (from  $S_N2$ ). The presence of a phenyl group produces a carbonium ion which can be stabilised by resonance; this acts as the driving force to produce ionisation; *e.g.*,

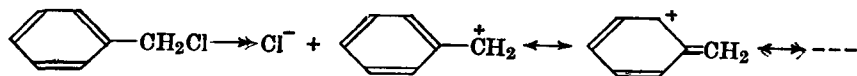

Thus one can anticipate that as the number of phenyl groups increases, the stability of the carbonium ion produced will increase, *i.e.*, the carbonium ion will be formed more readily and consequently the  $S_N1$  mechanism will



be increasingly favoured. Thus in the series  $\text{MeCl}$ ,  $\text{PhCH}_2\text{Cl}$ ,  $\text{Ph}_2\text{CHCl}$ ,  $\text{Ph}_3\text{CCl}$ , it has been found that in alkaline solution the hydrolysis of methyl chloride proceeds by the  $\text{S}_{\text{N}}2$  mechanism, that of phenylmethyl chloride by both  $\text{S}_{\text{N}}2$  and  $\text{S}_{\text{N}}1$ , and that of diphenylmethyl chloride by  $\text{S}_{\text{N}}1$ ; the hydrolysis of triphenylmethyl chloride is too fast to be measured, but this high rate is very strong evidence for an  $\text{S}_{\text{N}}1$  mechanism.

Various groups in the *para*-position of the phenyl nucleus either assist or oppose ionisation. It has been found that alkyl groups enhance ionisation in the order  $\text{Me} > \text{Et} > i\text{-Pr} > t\text{-Bu}$ . Since this order is the reverse of that expected from the general inductive effects of these groups, it has been explained by the hyperconjugative effects of these groups (which are in this order; see Vol. I). On the other hand, a nitro-group retards the ionisation, and this attributed to the electron-withdrawing effect of this group.

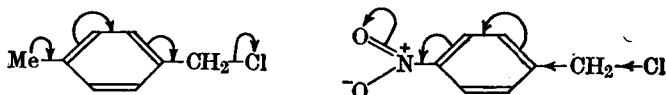

Another group of interest is the carbonyl group; this is electron-attracting (through resonance):

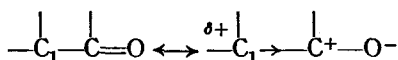

Thus the covalent electron-pair of a halogen atom attached to  $\text{C}_1$  is drawn closer to  $\text{C}_1$  and consequently it is more difficult for this halogen atom to ionise. Thus the  $\text{S}_{\text{N}}1$  mechanism is opposed, and at the same time, the small positive charge on  $\text{C}_1$  encourages the  $\text{S}_{\text{N}}2$  mechanism. It can therefore be anticipated that any electron-attracting (or withdrawing) group will tend to inhibit the  $\text{S}_{\text{N}}1$  mechanism for a compound with an  $\alpha$ -halogen atom. Such groups are  $\text{CO}_2\text{R}$ ,  $\text{NO}_2$ ,  $\text{CN}$ , etc.; e.g., both ethyl  $\alpha$ -bromopropionate and diethyl bromomalonate undergo hydrolysis by the  $\text{S}_{\text{N}}2$  mechanism.

On the other hand, the carboxylate ion has a +I effect due to its negative charge and hence its presence should enhance the ionisation of an  $\alpha$ -halogen atom. At the same time, the  $\alpha$ -carbon atom tends to acquire a small negative charge, and this will tend to oppose the approach of a hydroxide ion. Thus there are two influences acting, one increasing the tendency for the  $\text{S}_{\text{N}}1$  mechanism and the other decreasing the tendency for the  $\text{S}_{\text{N}}2$ ; both therefore oppose the  $\text{S}_{\text{N}}2$  mechanism. Some experimental results that illustrate these arguments are the alkaline hydrolyses of the following compounds:

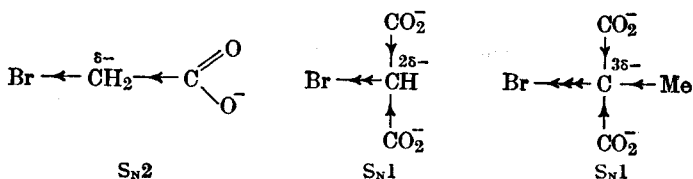

**§2b. The nature of R.** (b) *Steric effects.* In the transition state for the  $\text{S}_{\text{N}}2$  mechanism, there are five atoms or groups bonded or partly bonded to the reaction carbon atom (see §4). Thus the larger the bulk of these groups, the greater will be the compression energy (*i.e.*, greater steric strain) in the transition state and consequently the reaction will be *sterically hindered*. The problem is different for the  $\text{S}_{\text{N}}1$  mechanism. Here, the transition state does not contain more than four groups attached to the reaction carbon atom and hence one would expect that steric hindrance should be less important. On the other hand, if the molecule undergoing

the  $S_N1$  mechanism contains particularly large groups, then the first step of ionisation may relieve the steric strain (§4a. II) and so assist the formation of the carbonium ion, *i.e.*, the reaction may be *sterically accelerated*.

Let us now examine some examples involving steric effects.

(i) The following series of alkyl halides,  $\text{MeX}$ ,  $\text{EtX}$ ,  $i\text{-PrX}$  and  $t\text{-BuX}$ , may be made to undergo the  $S_N2$  mechanism under suitable conditions (*cf.* §2a); the transition state contains three  $\sigma$ -bonds ( $sp^2$  hybridisation) in one plane and two partial bonds which are collinear and perpendicular to this plane. Thus we have:

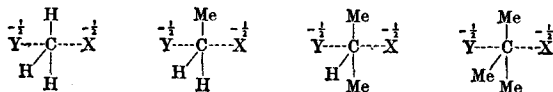

Inspection of these transition states shows that steric hindrance increases as the hydrogen atoms are progressively replaced by methyl groups. This increasing steric effect has been demonstrated by Hughes *et al.* (1946), who showed that the relative reactivities of the alkyl bromides towards iodide ions in acetone (by the  $S_N2$  mechanism) are: Me, 10,000; Et, 65;  $i\text{-Pr}$ , 0.50;  $t\text{-Bu}$ , 0.039.

Now let us consider  $n$ -propyl, isobutyl and neopentyl halides; their transition states will be (for the  $S_N2$  mechanism):

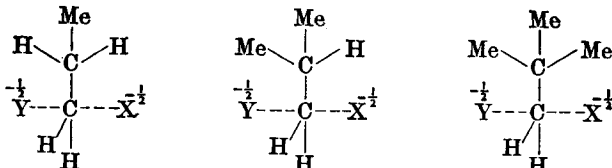

At first sight one would not expect  $n\text{-PrX}$  to show an added steric effect when compared with  $\text{EtX}$  since the added methyl group can occupy a position close to the plane of the transition state (*i.e.*, the plane containing the three  $\sigma$ -bonds), and so would not offer any appreciable steric hindrance. In practice, however,  $n$ -propyl halides are less reactive than the corresponding ethyl halides (*cf.* §2a). The reason for this relatively large decreased reactivity is not certain. Magat *et al.* (1950) have offered the following explanation. The smaller the number of conformations available in the activated as compared with the initial state produces a decrease in the frequency factor ( $A$  in the Arrhenius equation  $k = Ae^{-E/RT}$ ). In  $n$ -propyl halides (2 H and 1 Me) there is only one conformation for the transition state whereas for ethyl halides (3 H) there are three equivalent conformations. Thus the frequency factor for  $n$ -propyl halides is  $1/3$  that for the ethyl halides, and so the reaction rate ( $k$ ) of the former will be  $1/3$  that of the latter (on the assumption that  $E$  of both reactions is the same).

In isobutyl halides the methyl groups will produce a large steric effect since at least one methyl group will be fairly close to X or Y. It has been shown experimentally that isobutyl halides are less reactive than  $n$ -propyl halides. Finally, in neopentyl halides, the presence of three methyl groups produces a very large steric effect. In the "normal" transition state, the entering and displaced groups are collinear. This is readily possible with all the halides except possibly isobutyl halides; but it is not possible with neopentyl halides because of the presence of the three methyl groups (in the  $t$ -butyl group). Thus in the transition state involving the neopentyl radical, the  $\text{Y---C---X}$  bonds are believed not to be collinear but "bent away" from the  $t$ -butyl group. Such a "bent" transition state has a large compression energy and so is far more difficult to form than a "normal"

transition state. Experimental data are in agreement with these ideas, *e.g.*, Hughes *et al.* (1946) showed the following relative ( $S_N2$ ) reaction rates towards the ethoxide ion at  $95^\circ$ :



These very slow  $S_N2$  reactions of *neopentyl* halides occur with the *neopentyl* radical remaining intact. By changing the solvent conditions so that the mechanism becomes  $S_N1$ , the products are no longer *neopentyl* derivatives but rearranged products formed by a 1,2-shift (see §23d. VIII).

(ii) A very interesting example of steric hindrance is the case of 1-chloroapocamphane (I). Bartlett *et al.* (1938) found that this compound does not react with reagents that normally react with alkyl halides, *e.g.*, it is unaffected when refluxed with aqueous ethanolic potassium hydroxide or

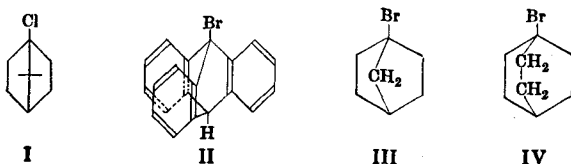

with ethanolic silver nitrate. As we have seen, the hydrolysis of *t*-butyl chloride takes place by the  $S_N1$  mechanism. 1-Chloroapocamphane is a tertiary chloride, but since it does not ionise, the  $S_N1$  mechanism is not possible. This failure to ionise is believed to be due to the fact that the carbonium ion is flat ( $sp^2$  hybridisation). Removal of the chloride ion from (I) would produce a positive carbon atom which *cannot* become planar because of the steric requirements of the bridged-ring structure. Furthermore, since the rear of the carbon atom of the C—Cl group is “protected” by the bridge, the  $S_N2$  mechanism is not possible (since the nucleophilic reagent must attack from the rear; see §4). The failure to replace bromine in 1-bromotriptycene (II) is explained similarly (Bartlett *et al.*, 1939). On the other hand, Doering *et al.* (1953) showed that (III) gave the corresponding alcohol when heated with aqueous silver nitrate at  $150^\circ$  for two days, and (IV) gave the corresponding alcohol after four hours at room temperature. The reason for this behaviour (as compared with the other bridged compounds) is not certain, but it has been suggested that the extra bonds in the larger bridge in (IV) help to relieve the strain in the formation of the carbonium ion which tries to assume a planar configuration.

(iii) Brown *et al.* (1949) showed that the solvolysis of tertiary halides is subject to steric acceleration. (*Solvolysis* is the nucleophilic reaction in which the *solvent* is the nucleophilic reagent.)

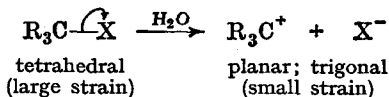

It was shown that as R increases in size, the rate of solvolysis increases. However, the larger R is, the more slowly will the carbonium ion be expected to react with the solvent molecules, and so a factor is introduced which opposes steric acceleration. Carbonium ions can undergo elimination reactions to form olefins (see also Vol. I), and Brown *et al.* (1950) have shown that this elimination reaction increases as the R groups become larger.

**§2c. The nature of the halogen atom.** Experimental work has shown that the nature of the halogen atom has very little effect, if any, on *mechanism*, but it does affect the *rate* of reaction for a given mechanism; *e.g.*, it has been found that in  $S_N1$  reactions, the rate follows the order

$RI > RBr > RCl$ . It has been suggested that a contributing factor to this order is steric strain, since the volume order of these halogen atoms is  $I > Br > Cl$ . Another contributing factor is the increase in energy of activation in the order  $RCl > RBr > RI$ , since the bond to be broken increases in strength in this order; the bond energies are: C—Cl, 77 kg.cal.; C—Br, 65 kg.cal.; C—I, 57 kg.cal. These energy differences also explain the order of reactivity  $RI > RBr > RCl$  in  $S_N2$  reactions.

**§2d. The nature of the nucleophilic reagent.** The more pronounced the nucleophilic activity of the reagent, *i.e.*, the greater its electron availability, the more the  $S_N2$  mechanism will be favoured as compared with the  $S_N1$  mechanism, since in the latter the nucleophilic reagent does not enter into the rate-determining step.

It can be anticipated that as nucleophilic activity decreases, the rate of an  $S_N2$  reaction will decrease for a given series of substitutions (under similar conditions), and when the nucleophilic activity is sufficiently low, the mechanism may change from  $S_N2$  to  $S_N1$ . Hughes, Ingold *et al.* (1935) examined the rates of decomposition of various trimethylsulphonium salts in ethanol ( $Me_3S^+X^- \rightarrow Me_3S + MeX$ ) and obtained the following results (see also §4):

Anion	OH <sup>-</sup>	OPh <sup>-</sup>	HCO <sub>2</sub> <sup>-</sup>	Br <sup>-</sup>	Cl <sup>-</sup>
2nd-order rate const. $\times 10^5$	74,300	1340	—	—	—
1st-order rate const. $\times 10^5$	—	—	7.38	7.85	7.32

It can be seen from these results that the strong nucleophiles OH<sup>-</sup> and OPh<sup>-</sup> react rapidly by the  $S_N2$  mechanism and the other, and weaker, nucleophiles react at about the same slow speed by the  $S_N1$  mechanism.

Although many kinetic investigations of displacement reactions with alkyl halides have been carried out, relatively little information is available for determining nucleophilicity. One set of data that may be cited is that obtained from the reaction between methyl iodide and various bases in benzene at 25° (Hinshelwood *et al.*, 1935):

	Pyridine	Me <sub>3</sub> N	Et <sub>3</sub> N	Quinoline
Relative rate	1	1730	144	0.26

A point of interest in connection with the nature of the nucleophile is that when it affects the rate of substitution, the reaction is usually proceeding by the  $S_N2$  mechanism. When the nature of the nucleophile has very little effect on the rate, then the reaction is probably  $S_N1$ . Another point to note is that steric effects in the nucleophile will also affect the rate of reaction, and this is probably a contributing factor to the different rates observed with reagents with similar nucleophilicity.

In general, it has been found that within a given periodic group, the nucleophilic activity increases with the atomic number of the atom, *e.g.*,

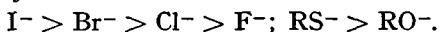

This order is opposite to that anticipated on the basis of basicities (and steric effects) of the different nucleophiles. This lack of some sort of parallelism between nucleophilic reactivity and basicity is unexpected, since both of these properties depend on the donating power of the donor atom. However, as a result of experimental work, it is now well established that

nucleophilic reactivity does not follow the order of increasing basicity towards protons, but varies with the nature of the reaction and with the reaction conditions.

**§2e. The effect of the solvent on mechanisms and reaction rates.** Experimentally, it has been found that the ionising power of a solvent depends on at least two factors, dielectric constant and solvation.

*Dielectric constant.* A very rough generalisation is that ionisation of the solute increases both in amount and speed the higher the dielectric constant of the solvent.

*Solvation.* This factor appears to be more important than the dielectric constant. Solvation is the interaction between solvent molecules and solute molecules, and is partly accounted for by the attraction of a charge for a dipole. If the solute has polarity, then solvent molecules will be attracted to the solute molecules. The greater the polarity of the solvent, the greater the attraction and consequently the more closely the solvent molecules will be drawn to the solute molecules. Thus more electrostatic work is done and so more energy is lost by the system, which therefore becomes more stable. Thus increasing the dielectric constant of the solvent increases the ionising potentiality of the solute molecules, and the higher the polarity of the solvent the more stable becomes the system due to increased solvation. Solvation, however, may also be partly due to certain chemical properties, e.g., sulphur dioxide has an electrophilic centre (the sulphur atom carries a positive charge); hydroxylic solvents can form hydrogen bonds.

There is also another problem that may arise. This is that although the solute molecules have ionised, the oppositely charged pair are enclosed in a "cage" of surrounding solvent molecules and may therefore recombine before they can escape from the cage. Such a complex is known as an *ion-pair*, and their recombination is known as *internal return*. It has now been shown that many organic reactions proceed *via* ion-pairs rather than dissociated ions. According to some authors there are two types of ion-pairs:

(i) *Intimate* or *internal* ion-pairs. These are enclosed in a solvent cage and the ions of the pair are *not* separated by solvent molecules.

(ii) *Loose* or *external* ion-pairs. The ions of these pairs are separated by solvent molecules but still behave as a pair. External ion-pairs may also give rise to ion-pair return (*external return*), but they are more susceptible to attack by other reagents than are intimate ion-pairs. Many workers believe it unnecessary to postulate the existence of this type of ion-pair.

Thus, when ionisation takes place, the following steps are possible:

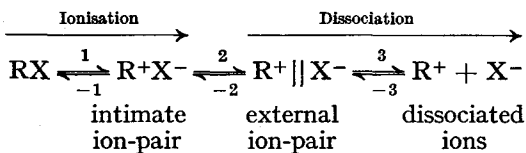

*N.B.* (i)  $-1$  is internal return, and it appears uncertain whether this type of ion-pair is a transition state or an intermediate; (ii)  $-2$  is external return; (iii) only equilibrium 3 is sensitive to a common ion effect; this is because an ion-pair behaves as a single particle, as has been shown by the effect on the depression of the freezing point ( $i = 1$ ).

A number of equations have been proposed correlating rates and the nature of the solvent, but none is completely general. Hughes and Ingold (1935, 1948) proposed the following qualitative theory of solvent effects: (i) Ions and polar molecules, when dissolved in polar solvents, tend to become solvated. (ii) For a given solvent, solvation tends to increase with

increasing magnitude of charge on the solute molecules or ions. (iii) For a given solute, solvation tends to increase with the increasing dipole moment of the solvent. (iv) For a given magnitude of charge, solvation decreases as the charge is spread over a larger volume. (v) The decrease in solvation due to the dispersal of charge will be less than that due to its destruction.

Since the rate-determining step in the  $S_N1$  mechanism is ionisation, any factor assisting this ionisation will therefore facilitate  $S_N1$  reactions. Solvents with high dipole moments are usually good ionising media and, in general, it has been found that the more polar the solvent the greater is the rate of  $S_N1$  reactions. We have, however, also to consider the problem of solvation.

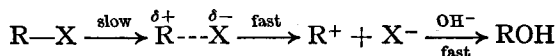

Increasing the polarity of the solvent will greatly increase the reaction rate, and since the transition state has a larger charge than the initial reactant molecule, the former is more solvated than the latter (rule ii). Thus the transition state is more stabilised than the reactant molecule. Thus solvation lowers the energy of activation and so the reaction is assisted.

The rates of  $S_N2$  reactions are also affected by the polarity of the solvent.

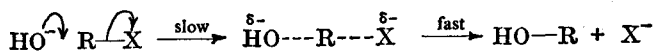

A solvent with high dipole moment will solvate both the reactant ion and the transition state, but more so the former than the latter, since in the latter the charge, although unchanged in magnitude ( $\delta^- = -1/2$ ), is more dispersed than in the former (rule iv). Thus solvation tends to stabilise the reactants more than the transition state, *i.e.*, the activation energy is increased and so the reaction is retarded.

Now let us consider the Menshutkin reaction:

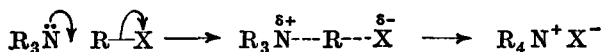

The charge on the transition state is greater than that on the reactant molecules; hence the former is more solvated than the latter. Thus the energy of activation is lowered and the rate of reaction thereby increased. Also, the greater the polarity of the solvent, the greater should be the solvation. The foregoing predictions have been observed experimentally.

In the following  $S_N2$  reaction, charges decrease in the transition state,

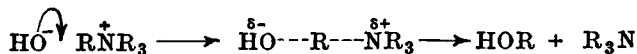

and hence increasing the polarity of the solvent will retard the reaction; and retardation will be greater than that in the  $S_N2$  hydrolysis of alkyl halides (see above; only the hydroxide ion is charged in this case).

The polarity of the solvent not only affects rates of reactions, but may also change the mechanism of a reaction, *e.g.*, Olivier (1934) showed that the alkaline hydrolysis of benzyl chloride in 50 per cent. aqueous acetone proceeds by both the  $S_N2$  and  $S_N1$  mechanisms. In water as solvent, the mechanism was changed to mainly  $S_N1$ . The dipole moment of water is greater than that of aqueous acetone, and consequently the ionisation of benzyl chloride is facilitated.

Another example we shall consider is the hydrolysis of the alkyl bromides, MeBr, EtBr, *i*-PrBr and *t*-BuBr. As we have seen (§2a), Hughes, Ingold *et al.* showed that in aqueous alkaline ethanol the mechanism changed from  $S_N2$  for MeBr and EtBr to both  $S_N2$  and  $S_N1$  for *i*-PrBr, and to  $S_N1$

for *t*-BuBr. These results were explained by the +I effects of the R groups, but it also follows that the greater the ionising power of the solvent, the less will be the +I effect of an R group necessary to change the mechanism from S<sub>N</sub>2 to S<sub>N</sub>1. Formic acid has been found to be an extremely powerful ionising solvent for alkyl halides, and the relative rates of hydrolysis, at 100°, for the above series of bromides with the very weak nucleophilic reagent water, dissolved in formic acid, was found to be (Hughes *et al.*, 1937, 1940): MeBr, 1.00; EtBr, 1.71; *i*-PrBr, 44.7; *t*-BuBr, *ca.* 10<sup>8</sup>. This continuous increase in reaction rate shows that the mechanism is mainly S<sub>N</sub>1 (the rate increasing with the increasing +I effect of the R group). Thus both MeBr and EtBr are also hydrolysed by the S<sub>N</sub>1 mechanism under these favourable conditions of high solvent-ionising power.

Solvents may also affect the proportions of the products in competitive reactions, *i.e.*, the attack on the same substrate by two substituting reagents in the same solution:



In the S<sub>N</sub>2 mechanism there is only one reaction step, and so the overall rate and product ratio will be determined by that stage. In the S<sub>N</sub>1 mechanism, however, the rate is determined by the rate of ionisation of RX, and the product ratio is thus determined by the competition of the fast second steps. It therefore follows that for solvent changes, in the S<sub>N</sub>2 mechanism the rate and product ratio will proceed in a parallel fashion, whereas in the S<sub>N</sub>1 mechanism the rate and product ratio will be independent of each other. A simple example that illustrates this problem is the solvolysis of benzhydryl chloride (diphenylmethyl chloride). Hammett *et al.* (1937, 1938) showed that the solvolysis of benzhydryl chloride in initially neutral aqueous ethanol gave benzhydryl ethyl ether and benzhydrol. Hughes, Ingold *et al.* (1938) showed that if ethanol is first used as solvent and then water is progressively added, the overall rate increases, but there is very little increase in benzhydrol formation; the main effect is an increased rate of formation of benzhydryl ethyl ether. Thus the rate of the reaction and the ratio of the products are determined independently; this is consistent with the S<sub>N</sub>1 mechanism but not with the S<sub>N</sub>2.

It can be seen from this example that kinetic solvent effects may be used to differentiate between S<sub>N</sub>2 and S<sub>N</sub>1 mechanisms.

**§3. The Walden inversion (Optical inversion).** By a series of replacement reactions, Walden (1893, 1895) transformed an optically active compound into its enantiomorph. In some cases the product is 100 per cent. optically pure, *i.e.*, the inversion is quantitative; in other cases the product is a mixture of the (+)- and (-)-forms in unequal amounts, *i.e.*, inversion and retention (racemisation) have taken place.

The phenomenon was first discovered by Walden with the following reactions:

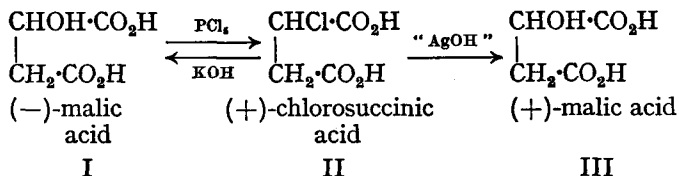

This conversion of the (-)-form into the (+)-form constitutes a Walden inversion. The Walden inversion was "defined" by Fischer (1906) as the conversion of the (+)-form into the (-)-form, or *vice versa*, without recourse to resolution. In one, and only one, of the two reactions, must there be an

interchange of position between the two groups, *e.g.*, if the configuration of (I) corresponds with that of (II), the inversion of configuration must have taken place between (II) and (III). Now that the mechanism of substitution at a saturated carbon has been well worked out, the term *Walden inversion* is applied to any *single* reaction in which inversion of configuration occurs.

As the above experiment stands, there is no way of telling which stage is accompanied by inversion. As we have seen (§5b. II), change in sign of rotation does not necessarily mean that inversion configuration has occurred. Various methods of correlating configuration have already been described (§5a. II), but here we shall describe the method where bonds attached to the asymmetric carbon atom are broken during the course of the reactions. This method was established by Kenyon *et al.* (1925), who carried out a series of reactions on optically active hydroxy compounds. Now it has been established that in the esterification of a monocarboxylic acid by an alcohol under ordinary conditions, the reaction proceeds by the acyl-oxygen fission mechanism (see also Vol. I); thus:

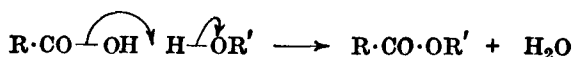

Kenyon assumed that in all reactions of this type the R'-O bond remained intact and consequently no inversion of the alcohol is possible. The following chart shows a series of reactions carried out on ethyl (+)-lactate; Ts = tosyl group = *p*-toluenesulphonyl group, *p*-Me·C<sub>6</sub>H<sub>4</sub>·SO<sub>2</sub>-; the symbol  $\xrightarrow{\ominus}$  is used to represent inversion of configuration in that step. (IV) and

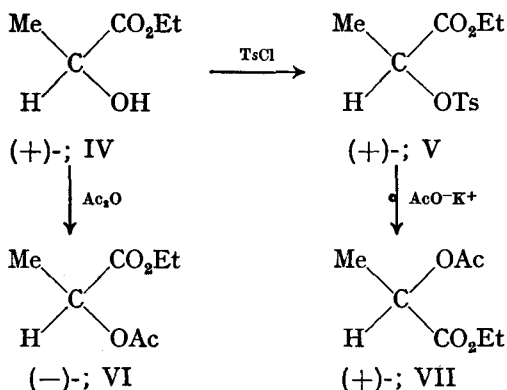

(VI) have the same relative configurations even though the sign of rotation has changed. Similarly, (IV) and (V) have the same relative configurations. Reaction of (V) with potassium acetate, however, produces (VII), the enantiomorph of (VI). Therefore inversion must have occurred in the formation of (VII); (V) and (VI) are produced without inversion since in these cases the C—O bond in (IV) is never broken. It should be noted here that if inversion is going to take place at all, the *complete group* attached to the asymmetric carbon atom must be removed (in a displacement reaction) (*cf.* Fischer's work on (+)-isopropylmalonic acid, §3a. II). The converse, however, is not true, *i.e.*, removal of a complete group does not invariably result in inversion (see later, particularly §4).

The above series of reactions has been used as a standard, and all closely analogous reactions are assumed to behave in a similar way, *e.g.*, the action of lithium chloride on the tosylate (V) is assumed to be analogous to that



of potassium acetate, and the chloride produced thus has an inverted configuration:

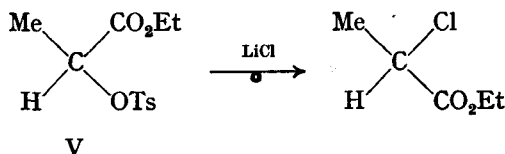

By similar procedures, Kenyon *et al.* (1929, 1930) showed that (+)-octan-2-ol and (+)-2-chloro-, 2-bromo- and 2-iodo-octane have the same relative configurations; and also that (+)- $\alpha$ -hydroxyethylbenzene (Ph·CHOH·Me), (+)- $\alpha$ -chloro- and (+)- $\alpha$ -bromoethylbenzene have the same relative configurations (see also the S<sub>N</sub>2 mechanism, §4).

**§4. Mechanism of the Walden inversion.** As the result of a large amount of work on the Walden inversion, it has been found that at least three factors play a part in deciding whether inversion or retention (racemisation) will occur: (i) the nature of the reagent; (ii) the nature of the substrate; (iii) the nature of the solvent. Hence it is necessary to explain these factors when dealing with the mechanism of the Walden inversion.

Many theories have been proposed, but we shall discuss only the Hughes–Ingold theory, since this is the one now accepted. According to this theory, aliphatic nucleophilic substitution reactions may take place by either the S<sub>N</sub>2 or S<sub>N</sub>1 mechanism (see also §5).

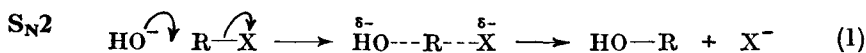

Hughes *et al.* (1935) studied (a) the interchange reaction of (+)-2-iodo-octane with radioactive iodine (as NaI\*) in acetone solution, and (b) the racemisation of (+)-2-iodo-octane by ordinary sodium iodide under the same conditions. These reactions were shown to take place by the S<sub>N</sub>2 mechanism, and the rate of racemisation was shown to be twice the rate of radioactive exchange, *i.e.*, every iodide–iodide\* displacement is always accompanied by inversion. (Suppose there are  $n$  molecules of optically active iodo-octane. When  $n/2$  molecules have exchange with I\* and in doing so have been inverted, racemisation is now complete although the exchange has taken place with only *half* of the total number of molecules.) Thus this experiment leads to the *assumption* that inversion always occurs in the S<sub>N</sub>2 mechanism. This is fully supported by other experimental work, *e.g.*, Hughes *et al.* (1936, 1938) studied the reaction of optically active  $\alpha$ -bromoethylbenzene and  $\alpha$ -bromopropionic acid with radioactive bromide ions, and again found that the rates of exchange (of bromide ions) and inversion were the same.

Thus the Walden inversion affords a means of studying the mechanism of substitution reactions. If complete inversion occurs, the mechanism is S<sub>N</sub>2, or conversely, if the mechanism is known to be S<sub>N</sub>2 (by, *e.g.*, kinetic data), complete inversion will result. This is the stereokinetic rule for S<sub>N</sub>2 reactions, and its use thus offers a means of correlating configurations.

The essential problem that now arises is the consideration of the forces that determine the direction of attack, since the S<sub>N</sub>2 mechanism might conceivably have taken place with retention as follows:

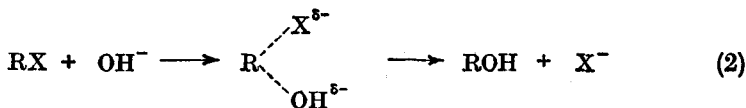

Polanyi *et al.* (1932) suggested that the polarity of the C—X bond causes the negative ion (such as OH<sup>-</sup>) to approach the molecule RX from the side *remote* from X; this is *end-on* attack:

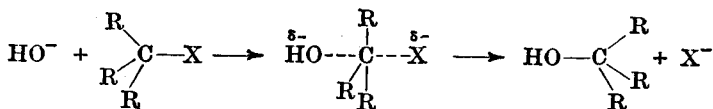

Hughes and Ingold (1937), however, suggested from quantum-mechanical arguments that, independently of the above electrostatic repulsions, the minimum energy of activation results when the attacking ion approaches from a direction that would lead to inversion. Furthermore, these authors believe that the quantum-mechanical forces are more powerful than the electrostatic forces. There is much evidence to support this, *e.g.*, if electrostatic forces were the only or the predominating factor, then attack by a negatively charged nucleophilic reagent on a compound in which the displaced group has a positive charge would be expected to occur with retention (equation 2). In practice, however, inversion is still obtained, *e.g.*, the acetoxyl ion attacks the (+)-trimethyl- $\alpha$ -phenylethylammonium ion to give inversion (Snyder *et al.*, 1949):

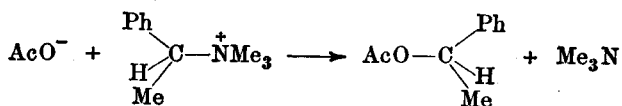

A point of interest about the S<sub>N</sub>2 reaction is that there are *four* electrostatically distinct types:

		<i>Reagent</i>	<i>Substrate</i>
1.	$\text{Y}^- + \text{RX} \longrightarrow \text{YR} + \text{X}^-$	negative	neutral
2.	$\text{Y}^- + \text{RX}^+ \longrightarrow \text{YR} + \text{X}$	negative	positive
3.	$\text{Y} + \text{RX} \longrightarrow \text{YR}^+ + \text{X}^-$	neutral	neutral
4.	$\text{Y} + \text{RX}^+ \longrightarrow \text{YR}^+ + \text{X}$	neutral	positive

The stereokinetic rule for S<sub>N</sub>2 reactions is well established for only reactions of type 1. Hughes, Ingold *et al.* (1960) have also shown that the rule applies to type 2, *e.g.*, the reaction between a sulphonium iodide and sodium azide (*cf.* Snyder's work):

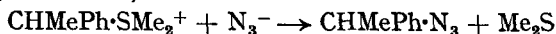

These authors have also demonstrated that type 4 proceeds by the S<sub>N</sub>2 mechanism, *e.g.*, with a sulphonium nitrate:

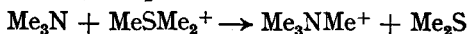

Now let us consider the S<sub>N</sub>1 mechanism.

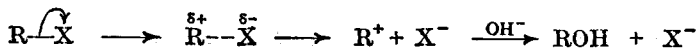

When the reaction proceeds by this mechanism, then inversion and retention (racemisation) will occur, the amount of each depending on various factors. The carbonium ion is flat (trigonal hybridisation), and hence attack by the nucleophilic reagent can take place equally well on either side, *i.e.*, equal amounts of the (+)- and (-)-forms will be produced; this is racemisation. One can expect complete racemisation only if the carbonium ion has a sufficiently long life; this is favoured by low reactivity of the carbonium ion and low concentration of the nucleophilic reagent. However, during the actual ionisation step, the retiring group will "protect" the carbonium ion from attack on that side, *i.e.*, there is a shielding effect, and this encourages an end-on attack on the other side, thereby leading to

inversion. An example of this type is the following. Bunton *et al.* (1955) studied the reaction of  $^{18}\text{O}$ -enriched water on optically active *s*-butanol in aqueous perchloric acid, and found that the overall rate of racemisation is twice that of the oxygen exchange. Thus every oxygen exchange causes complete inversion of configuration (*cf.* the iodide-iodide\* exchange described above). Bunton proposed the following mechanism to explain these results:

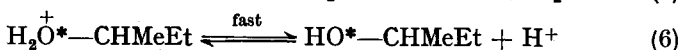
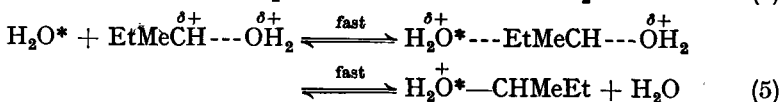
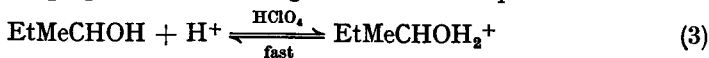

(5) occurs before the  $\text{OH}_2^+$  has completely separated in (4), and so this side is shielded and the  $\text{H}_2\text{O}^*$  is forced to attack on the other side as shown; the result is thus inversion. The above reaction proceeds by the  $\text{S}_{\text{N}}1$  mechanism since (4) is the rate-determining step (only *one* molecule is undergoing covalency change in this step). Had the reaction been  $\text{S}_{\text{N}}2$ , complete inversion would still have been obtained. It was shown, however, that the reaction rate was independent of the concentration of  $\text{H}_2\text{O}^*$ . The mechanism is therefore  $\text{S}_{\text{N}}1$ , since had it been  $\text{S}_{\text{N}}2$ , the kinetic expression would require the concentration of the  $\text{H}_2\text{O}^*$ :

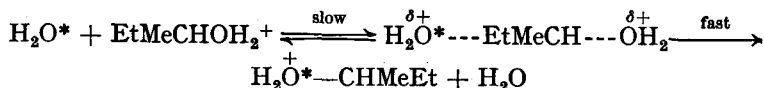

The stereochemical course of  $\text{S}_{\text{N}}1$  reactions may also be affected by neighbouring group participation (see, *e.g.*, §6a).

§5. The  $\text{S}_{\text{N}}i$  mechanism. Another important  $\text{S}_{\text{N}}$  reaction is the  $\text{S}_{\text{N}}i$  type (substitution, nucleophilic, internal). The reaction between thionyl chloride and alcohols has been studied extensively. A well-examined example is the alcohol  $\alpha$ -phenylethanol,  $\text{PhCHOHMe}$ ; this is an *arylmethanol*, and according to Hughes, Ingold *et al.* (1937), the first step is the formation of a chlorosulphinate. No inversion occurs at this stage (which is a four-centre reaction); in the following equations,  $\text{R} = \text{PhMeCH}-$ :

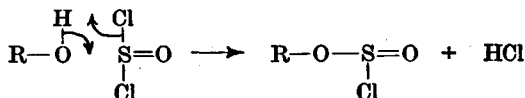

This chlorosulphinate could then form  $\alpha$ -chloroethylbenzene by one or more of the following mechanisms:

(i)  $\text{S}_{\text{N}}2$ . This occurs with inversion.

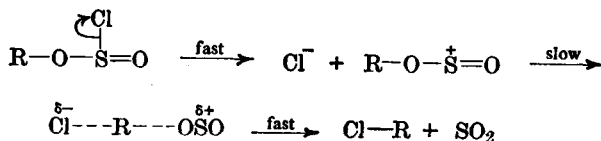

(ii)  $\text{S}_{\text{N}}1$ . This occurs with inversion and retention (racemisation).

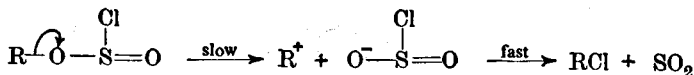

The second stage may possibly be:

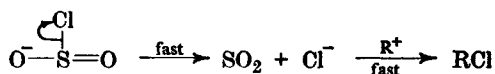

(iii)  $\text{S}_{\text{N}}\text{i}$ . This occurs with retention (the reaction is effectively a four-centre type).

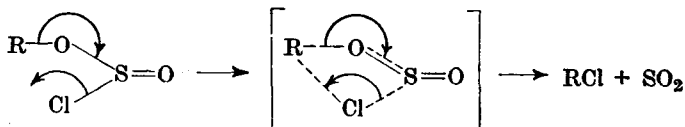

In practice, the  $\alpha$ -chloroethylbenzene obtained has almost complete retention of configuration, and consequently the mechanism must be  $\text{S}_{\text{N}}\text{i}$ . A point of interest here is that it is apparently difficult to postulate the nature of the transition state in this mechanism.

When  $\alpha$ -phenylethanol and thionyl chloride react in the presence of pyridine, the  $\alpha$ -chloroethylbenzene obtained now has the inverted configuration (Hughes, Ingold *et al.*, 1937). The explanation offered is that the  $\text{S}_{\text{N}}2$  mechanism is operating, the substrate now being a pyridine complex:

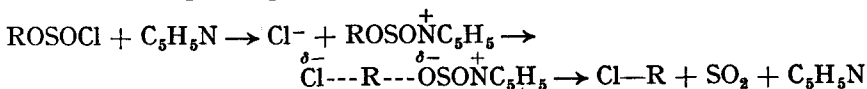

Optically active  $\alpha$ -phenylethanol reacts with phosphorus trichloride, phosphorus pentachloride, and phosphoryl chloride, in the presence or absence of pyridine, and with hydrochloric acid, to give the *inverted* chloride. Thus all these proceed by the  $\text{S}_{\text{N}}2$  mechanism. It is reasonable to assume that the chloride ion attacks some intermediate other than a pyridinium ion, since inversion occurs whether pyridine is present or absent.

**§6. Participation of neighbouring groups in nucleophilic substitutions.** So far, we have discussed polar effects (inductive and resonance) and steric effects on the rates and mechanisms of reactions. In recent years it has been found that another factor may also operate in various reactions. This factor is known as *neighbouring group participation*. Here we have a group attached to the carbon atom *adjacent* to the carbon atom where nucleophilic substitution occurs and, during the course of the reaction, becomes bonded or partially bonded to the reaction centre. Thus the rate and/or the stereochemistry of a reaction may be affected by this factor. When a reaction is accelerated by neighbouring group participation, that reaction is said to be *anchimerically assisted* (Winstein *et al.*, 1953). For anchimeric assistance to occur, the neighbouring group, which behaves as a nucleophilic reagent, must be suitably placed stereochemically with respect to the group that is ejected. This is the *trans*-configuration, and in this configuration the conditions for intramolecular displacement are best. Neighbouring group participation is also of great importance in the 1,2-shifts (see Vol. I; see also §2h. VI).

**§6a. Neighbouring carboxylate anion.** Hughes, Ingold *et al.* (1937) studied the following reaction of methyl *D*- $\alpha$ -bromopropionate:

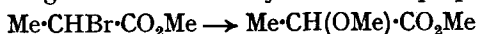

With concentrated methanolic sodium methoxide, the reaction was shown to be  $\text{S}_{\text{N}}2$ , and the product was *L*-methoxy ester (100 per cent. inversion). Under these conditions, the nucleophilic reagent is the methoxide ion, and the reaction is first order with respect to both methoxide ion and ester.

When the ester was subjected to methanolysis, *i.e.*, methanol was the solvent (no methoxide ion now present), the product was again *L*-methoxy ester (100 per cent. inversion). The reaction was now first order (*i.e.*, pseudo first order), but still  $S_N2$ , the nucleophilic reagent being the solvent molecules of methanol. When the sodium salt of *D*- $\alpha$ -bromopropionic acid was hydrolysed in dilute sodium hydroxide solution, the mechanism was shown to be  $S_N1$ , and the product was now *D*- $\alpha$ -hydroxypropionate anion (100 per cent. retention). In concentrated sodium hydroxide solution, however, the mechanism was  $S_N2$  (due to the high concentration of the hydroxide ion), and the product was *L*- $\alpha$ -hydroxypropionate anion (100 per cent. inversion).

Hughes and Ingold have proposed the following explanation for the retention experiment. The first step is ionisation to a carbonium ion in which the negatively charged oxygen atom forms a "weak electrostatic bond" with the positively charged carbon atom on the side remote from that where the bromide ion is expelled. Thus this remote side is "protected" from attack by the hydroxide ion, which is consequently forced to attack from the same side as that of the expelled bromide ion, thereby leading to retention of configuration.

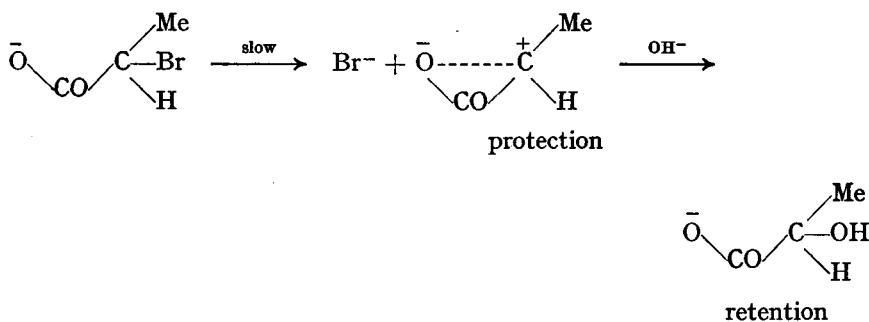

Hughes, Ingold *et al.* (1950) showed that the deamination of optically active alanine by nitrous acid gave an optically active lactic acid with retention of configuration. This is also explained by neighbouring group participation of the  $\alpha$ -carboxylate anion:

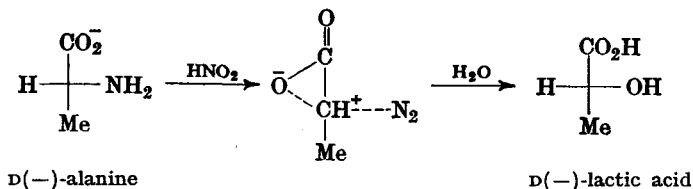

This effect of neighbouring group participation is supported by the fact that in the absence of the  $\alpha$ -carboxylate ion, Hughes, Ingold *et al.* observed that there was an overall inversion of configuration (with much racemisation) in the deamination of simple optically active amines, and explained this as being due to asymmetrical shielding of the carbonium ion by the expelled nitrogen.

As we have seen above, neighbouring group participation involves a group on the *adjacent* carbon atom. Austin *et al.* (1961) have offered an example where the "neighbouring group" is on the  $\gamma$ -carbon atom. These authors have shown that there is 80 per cent. retention of configuration in the deamination of  $\gamma$ -aminovaleric acid; the product is a lactone. Thus a "free" carbonium ion is not involved in the formation of the lactone,

The authors suggest the following mechanism, neighbouring group participation occurring as shown:

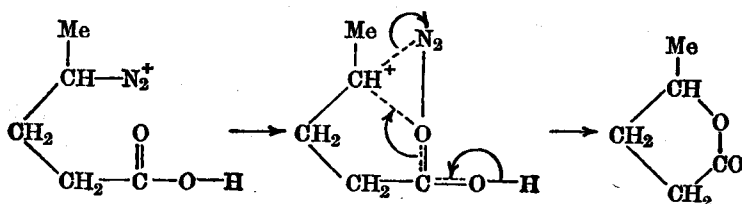

Thus the oxygen atom of the  $\gamma$ -carboxyl group enters the site, originally occupied by the amino-group, by an  $S_Ni$  mechanism.

§6b. **Neighbouring halogen atoms.** Brominium (bromonium) ions were first proposed by Roberts and Kimball (1937) as intermediates in the addition of bromine to olefins (see §5. IV). The existence of this cyclic brominium ion has been demonstrated by Winstein and Lucas (1939), who found that the action of fuming hydrobromic acid on (*-*)-*threo*-3-bromobutan-2-ol gave ( $\pm$ )-2,3-dibromobutane.

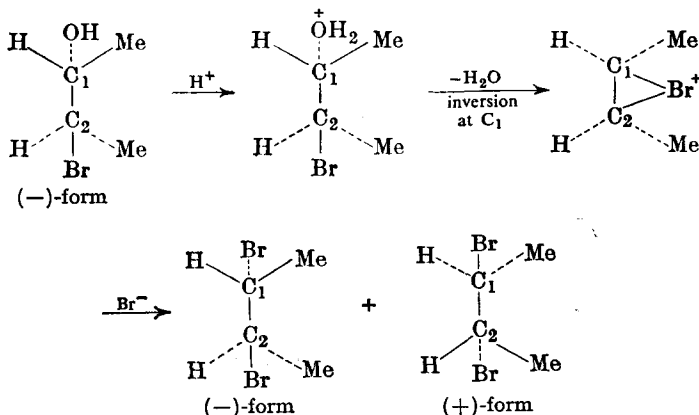

If no neighbouring group participation of bromine occurred in the above reactions, then if the reaction were  $S_N2$ , complete inversion would have

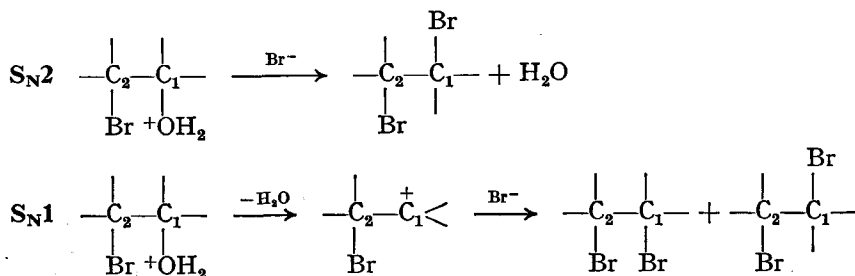

occurred only at  $C_1$ . If the reaction were the ordinary  $S_N1$ , the  $C_1$  would have been a classical carbonium ion (flat), and so inversion and retention (racemisation) would have occurred only at  $C_1$ . Since either retention of inversion occurs at *both*  $C_1$  and  $C_2$ , the results are explained by neighbouring group participation of the bromine atom.

The above mechanism also explains the formation of *meso*-2,3-dibromobutane by the action of fuming hydrobromic acid on optically active *erythro*-

3-bromobutan-2-ol (I); (II) and (III) are identical and correspond to the *meso*-form.

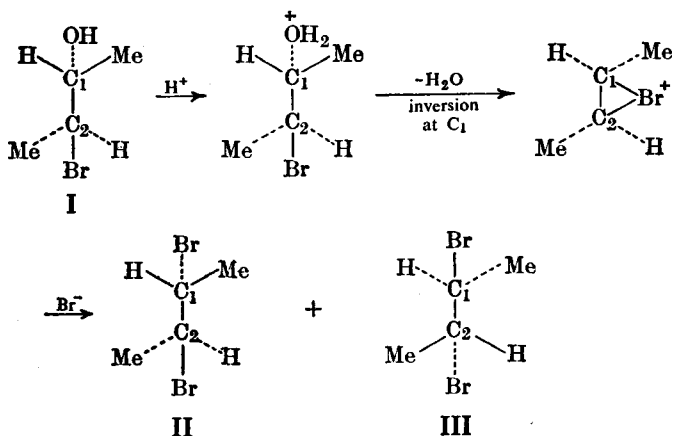

There is evidence that all the halogen atoms can form cyclic ions and offer anchimeric assistance, *e.g.*, Winstein *et al.* (1948, 1951) studied the acetolysis of *cis*- and *trans*-2-halogeno-cyclohexyl brosylates (*i.e.*, *p*-bromobenzenesulphonates; this group is often written as OBs):

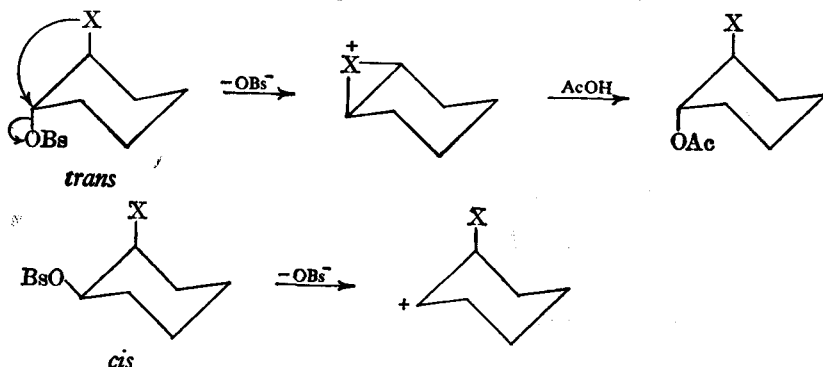

In the absence of neighbouring group participation, the rates would be expected to be about the same. If participation occurs, then this is readily possible in the *trans*-isomer (1*a* : 2*a*) by attack of X at the *rear* of the ejected OBs<sup>-</sup> ion, but this is not so for the *cis*-isomer (1*e* : 2*a*; see §11. IV). The rate ratios observed were:

$$\textit{trans}/\textit{cis}: \text{X} = \text{I}, 2.7 \times 10^6/1; \text{X} = \text{Br}, 800/1; \text{X} = \text{Cl}, 3.8/1.$$

Thus iodine affords the greatest anchimeric assistance and chlorine the least (see also §6c).

**§6c. Neighbouring hydroxyl group.** Bartlett (1935) showed that alkali converts *trans*-2-chlorocyclohexanol into cyclohexene oxide, and proposed a mechanism in which an alkoxide ion is formed first and this then ring-closes with ejection of the chloride ion:

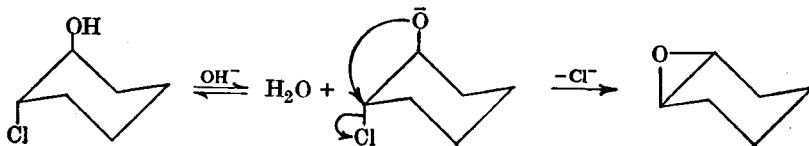

Bergvist (1948) showed that this reaction proceeds more than 100 times as fast as that when the *cis*-compound is used. Here again, the *trans*-form permits ready attack at the rear of the chloride ion whereas the *cis*-isomer does not (*cf.* §6b). The fact that the *cis*-form does react may be explained by assuming that the reaction proceeds *via* the *trans*-form, *i.e.*, the former is first converted into the latter. This requires energy of activation and consequently the reaction for the *cis*-form is slowed down (*cf.* §6d).

Another example of neighbouring hydroxyl participation is the conversion of sugars into epoxy-sugars (see §9. VII).

**§6d. Neighbouring acetoxy group.** Winstein *et al.* (1942, 1943) showed that a neighbouring acetoxy group leads to the formation of an acetoxonium ion. *trans*-2-Acetoxy-cyclohexyl brosylate (I) forms *trans*-1,2-diacetoxy-cyclohexane (II) when treated with silver acetate, and the same product (II) is obtained when the starting material is *trans*-2-acetoxy-cyclohexyl bromide (III). The authors believe that the course of the reaction, based on the stereochemical evidence, proceeds through the same acetoxonium ion (IV). This mechanism is supported by the fact that in each case, when the reaction was carried out in the presence of a small amount of water, the product was now the monoacetate of *cis*-cyclohexane-1,2-diol (V); some diacetate of this *cis*-diol was also obtained.

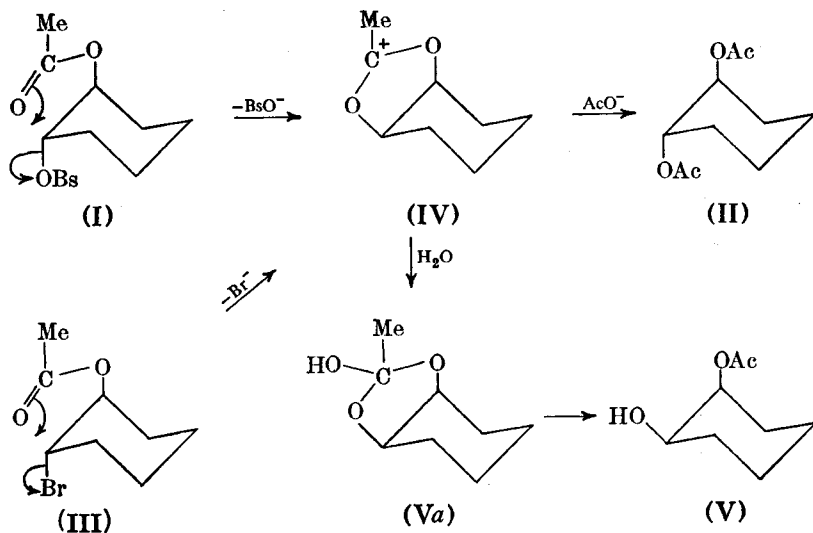

Further support for the formation of (IV) is afforded by the fact that the *cis*-isomers of (I) and (III) undergo the same reactions but at much slower rates; anchimeric assistance can readily operate in the *trans*-form. It is possible that for the *cis*-forms, the reactions proceed *via* the *trans*-forms, *i.e.*, the *cis*-form is first converted into the *trans*. This requires energy of activation and consequently the reactions with the *cis*-forms are slowed down. The formation of the intermediate (Va) is supported by the

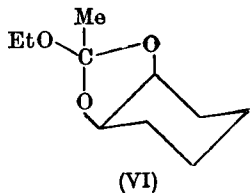



fact that when the solvolysis of (I) is carried out in ethanol, (VI) is obtained (Winstein *et al.*, 1943).

### ASYMMETRIC SYNTHESIS

§7. **Partial asymmetric synthesis.** Partial asymmetric synthesis may be defined as a method for preparing optically active compounds from symmetrical compounds by the intermediate use of optically active compounds, but without the necessity of resolution (Marckwald, 1904). In ordinary laboratory syntheses, a symmetrical compound always produces the racemic modification (§7a. II).

The first asymmetric synthesis was carried out by Marckwald (1904), who prepared an active (–)-valeric acid (lævorotatory to the extent of about 10 per cent. of the pure compound) by heating the half-brucine salt of ethylmethylmalonic acid at 170°.

I and II are diastereoisomers; so are III and IV. V and VI are enantiomorphs, and since the mixture is optically active, they must be present in unequal amounts. Marckwald believed this was due to the different rates of decomposition of diastereoisomers I and II, but according to Eisenlohr and Meier (1938), the half-brucine salts I and II are not present in equal amounts in the solid form (as thought by Marckwald). These authors suggested that as the less soluble diastereoisomer crystallised out (during

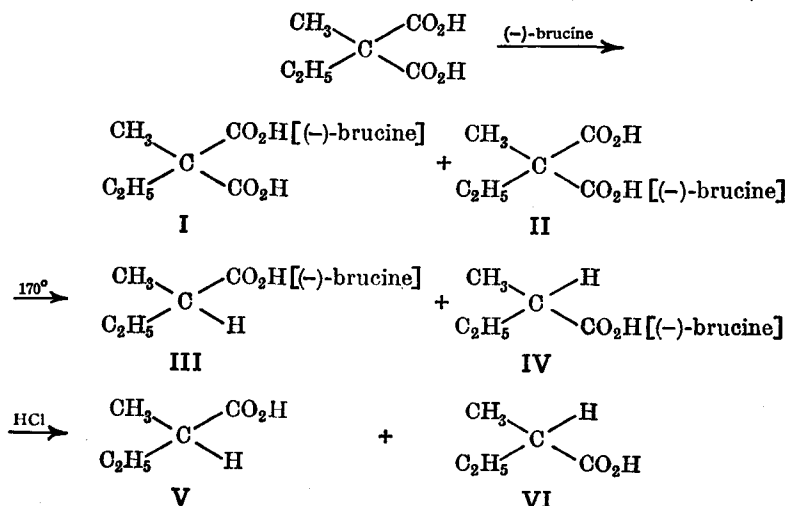

evaporation of the solution), some of the more soluble diastereoisomer spontaneously changed into the less soluble diastereoisomer to restore the equilibrium between the two; thus the final result was a mixture of the half-brucine salt containing a larger proportion of the less soluble diastereoisomer. If this be the explanation, then we are dealing with an example of asymmetric transformation and not of asymmetric synthesis (see §10. II). Further work, however, has shown that Marckwald had indeed carried out an asymmetric synthesis. Kenyon and Ross (1951) decarboxylated optically active ethyl hydrogen ethylmethylmalonate, VII, and obtained an optically inactive product, ethyl (±)-α-methylbutyrate, VIII.

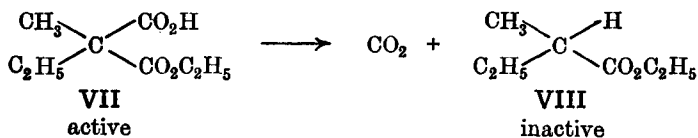

These authors (1952) then decarboxylated the cinchonidine salt of VII, and still obtained the optically inactive product VIII.

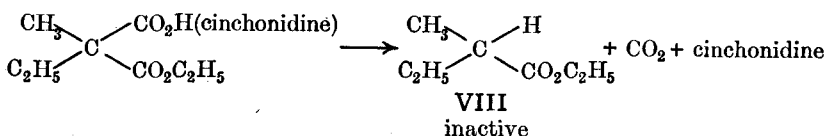

Kenyon and Ross suggest the following explanation to account for their own experiments and for those of Marckwald. Decarboxylation of diastereoisomers I and II takes place *via* the formation of the same carbanion Ia, and decarboxylation of VII and its cinchonidine salt *via* VIIa.

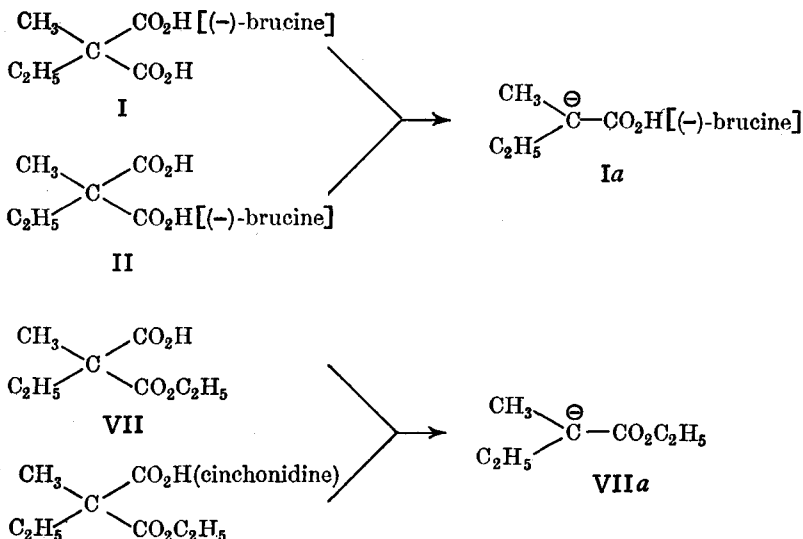

Combination of carbanion Ia with a proton will produce diastereoisomers III and IV in different amounts, since, in general, diastereoisomers are formed at different rates (§7*b*. II). On the other hand, carbanion VIIa will give equimolecular amounts of the enantiomorphs of VIII. If the formation of optically active  $\alpha$ -methylbutyric acid (V and VI) were due to different rates of decarboxylation of III and IV (Marckwald's explanation) or to partial asymmetric transformation during crystallisation (Eisenlohr and Meier's explanation), then these effects are nullified if Kenyon's explanation is correct, since the intermediate carbanion is the *same* for both diastereoisomers. Thus, if the asymmetric transformation theory were correct, then decarboxylation of the *dibrucine* salt of ethylmethylmalonic acid to  $\alpha$ -methylbutyric acid should give an optically inactive product, since only one type of crystal is now possible (asymmetric transformation is now impossible).

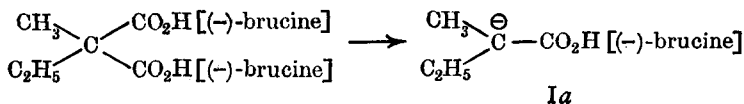

On the other hand, if the carbanion Ia is an intermediate in this decomposition, it is still possible to obtain an optically active product. Kenyon and Ross did, in fact, obtain a *laevorotatory* product.

McKenzie (1904) carried out a number of partial asymmetric syntheses by reduction of the keto group in various keto-esters in which the ester group contained an asymmetric group, *e.g.*, benzoylformic acid was esterified with (–)-menthol, the ester reduced with aluminium amalgam, and the resulting product saponified; the mandelic acid so obtained was slightly lævorotatory.

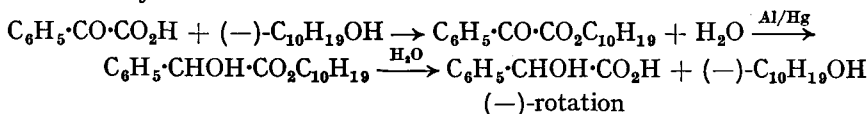

Similarly, the pyruvates of (–)-menthol, (–)-pentyl alcohol and (–)-borneol gave an optically active lactic acid (slightly lævorotatory) on reduction.

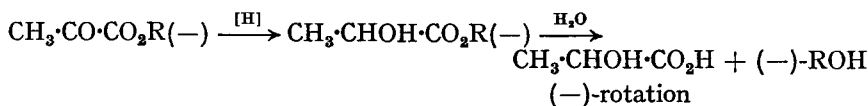

McKenzie (1904) also obtained similar results with Grignard reagents, *e.g.*, the (–)-menthyl ester of benzoylformic acid and methylmagnesium iodide gave a slightly lævorotatory atrolactic acid.

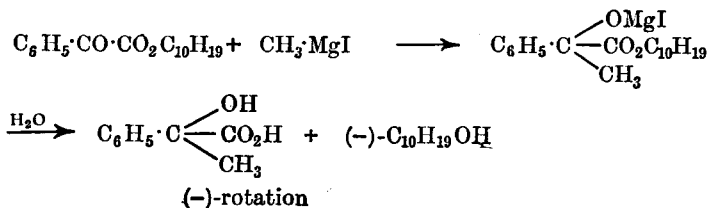

Turner *et al.* (1949) carried out a Reformatsky reaction (see Vol. I) using acetophenone, (–)-menthyl bromoacetate and zinc, and obtained a dextrorotatory β-hydroxy-β-phenylbutyric acid.

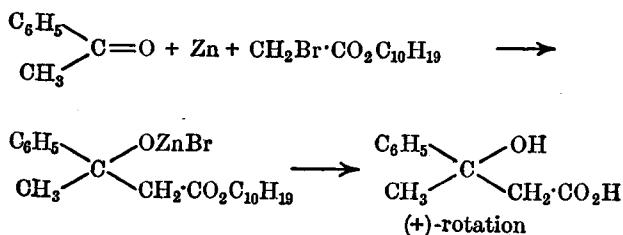

Reid *et al.* (1962) have also used aldehydes in the Reformatsky reaction, *e.g.*, benzaldehyde gave a lævorotatory β-hydroxy-β-phenylpropionic acid. Jackman *et al.* (1950) reduced *tert.*-butyl *n*-hexyl ketone with aluminium (+)-1 : 2 : 2-trimethylpropoxide at 200°, and obtained a slightly lævorotatory alcohol.

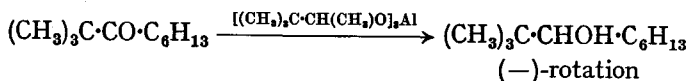

Another example of asymmetric synthesis involving the use of a Grignard reagent is the reduction of 3 : 3-dimethylbutan-2-one into a dextrorotatory

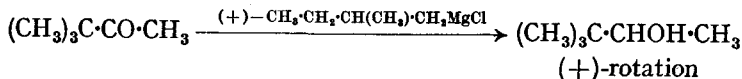

3 : 3-dimethylbutan-2-ol by means of (+)-2-methylbutylmagnesium chloride (Mosher *et al.*, 1950; see also Vol. I for abnormal Grignard reactions).

Bothner-By (1951) reduced butanone with lithium aluminium hydride in the presence of (+)-camphor, and thereby obtained (+)-isoborneol (from the camphor) and a small amount of a dextrorotatory butan-2-ol. The reducing agent in this case is a complex aluminohydride ion formed from lithium aluminium hydride and camphor, *e.g.*,  $\text{Al}(\text{OR})\text{H}_3^-$ .

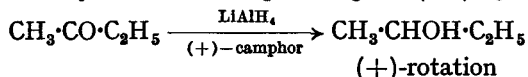

It has already been pointed out that a molecule containing one asymmetric carbon atom gives rise to a pair of diastereoisomers in *unequal* amounts when a second asymmetric carbon atom is introduced into the molecule (§7b. II). In general, if a new asymmetric centre is introduced into a molecule which is already asymmetric, the asymmetric part of the molecule influences the configuration formed from the symmetrical part of the molecule, the two diastereoisomers being formed in unequal amounts, *e.g.*, the Kiliani reaction (see also Vol. I).

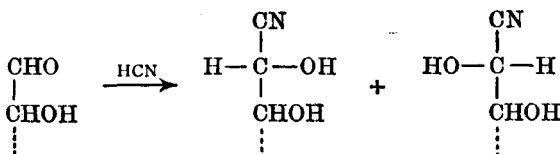

Prelog *et al.* (1953) have studied, by means of conformational analysis, the steric course of the addition of Grignard reagents to benzoylformic (phenylglyoxylic) esters of asymmetric alcohols. If the letters S, M and L refer respectively to small, medium and large groups attached to the carbinol carbon atom of the asymmetric alcohol, then the general reaction may be written:

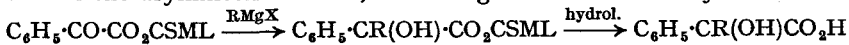

Prelog *et al.* found that the configuration of the asymmetric carbon atom in the stereoisomer that predominated in this reaction could be correlated with that of the carbinol carbon of the alcohol. The basis of this correlation was the assumption that the Grignard reagent attacks the carbon atom (of the ketone group) preferentially from the less hindered side. This necessitates a consideration of the possible conformations of the ester molecule. The authors considered that the most stable conformation of the ester was the one in which the two carbonyl groups are planar and *trans* to each other, with the smallest group lying in this plane and the other two groups skew. Furthermore, with the groups on the carbinol atom of the alcohol arranged in the staggered conformation with respect to the rest of the molecule, then IX and X will be the conformations of the esters with the enantiomorphous alcohol residues IX *a* and X *a* respectively (thick lines represent groups in front of the plane, broken lines groups behind, and ordinary lines groups in the plane). Thus, with L behind, methylmagnesium halide attacks preferentially from the front (IX); and with L in front, the attack is from behind (X). The  $\alpha$ -hydroxyacid obtained from IX is IX *b*, and that from X is X *b*. IX *b* and X *b* are enantiomorphs and hence the configuration of the new asymmetric centre is related to that of the adjacent asymmetric centre in the original molecule. Thus for the same keto-acid and the same Grignard reagent, and using different optically active alcohols belonging to the same configurational series, the product should contain excess of  $\alpha$ -hydroxyacids with the same sign of rotation. This has been shown to be so in practice, *e.g.*, (–)-menthol and (–)-borneol

are both configurationally related to L(-)-glyceraldehyde, and both lead to a predominance of the (-)-hydroxyacid. On the other hand, if the keto-acid is pyruvic acid and the Grignard reagent phenylmagnesium bromide, the (+)-hydroxyacid should predominate in the product (this method of preparation produces an interchange of the positions of the phenyl and methyl groups, thereby leading to the formation of the enantiomorph). This can

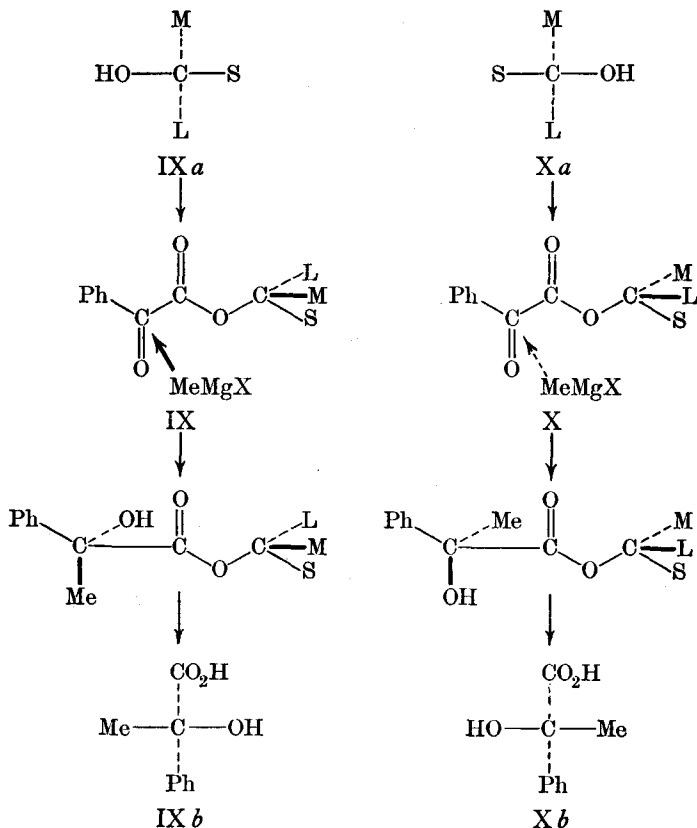

be seen from the following equation: starting with the pyruvic ester XI in which the configuration of the alcohol is IX a, the product would be X b.

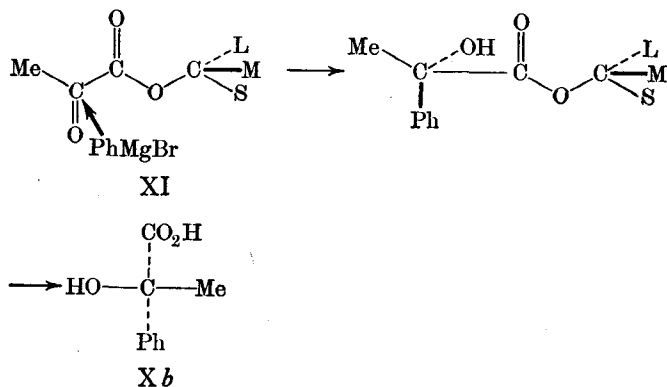

These results have been obtained in practice. Thus, when the configuration of the active alcohol is known, it is possible to deduce the configuration of the  $\alpha$ -hydroxyacid obtained in excess. This method has been used to determine the configuration of hydroxyl groups in steroids.

Cram *et al.* (1952) have also dealt with asymmetric syntheses in which the molecule contains an asymmetric centre that belongs to the molecule, *i.e.*, remains in the molecule (*cf.* the Kiliani reaction mentioned above). As a result of their work, these authors have formulated the rule of "steric control of asymmetric induction". This is: "In non-catalytic reactions of the type shown, that diastereoisomer will predominate which would be formed by the approach of the entering group from the *least hindered side* of the double bond when the rotational conformation of the C—C bond is such that the double bond is flanked by the two least bulky groups attached to the adjacent asymmetric centre." Thus :



or, using the Newman projection formulæ:

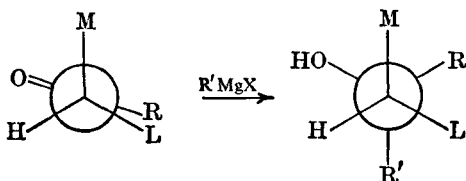

An example of this type of reaction is the reaction between phenylpropion-aldehyde ( $M = \text{Me}$ ,  $L = \text{Ph}$ ) and methylmagnesium bromide ( $R' = \text{Me}$ ); two products can be formed, *viz.*, XII (the *erythro*-compound) and XIII (the *threo*-compound):

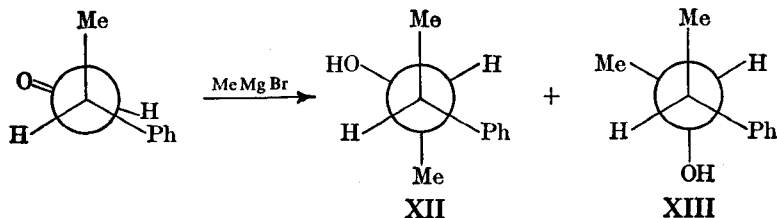

According to the above rule, XII should predominate; this has been found to be so in practice.

Cram's rule does not give the correct stereochemical prediction when one of the groups (*e.g.*, hydroxyl) attached to the carbon atom *alpha* to the carbonyl group is capable of chelating with a metal atom in the reagent, unless this chelating group is "medium" in effective bulk.

The influence of enzymes on the steric course of reactions has also been investigated, *e.g.*, Rosenthaler (1908) found that emulsin converted benzaldehyde and hydrogen cyanide into dextrorotatory mandelonitrile which was almost optically pure. It has been found that in most enzymic reactions the product is almost 100 per cent. of one or other enantiomorph. Enzymes are proteins and optically active (see also §12. XIII), but since they are so "one-sided" in their action, it appears likely that the mechanism of the reactions in which they are involved differs from that of partial asymmetric

syntheses where enzymes are not used. It has been suggested that enzymes are the cause of the formation of optically active compounds in plants. Although this is largely true, the real problem is: How were the optically active enzymes themselves produced? Ferreira's work [§10(viii). II], however, shows that optically active compounds may possibly be produced in living matter by activation of a racemic modification. This theory appears to be superior to that of the formation of optically active compounds by the action of naturally polarised light (see following section).

**§8. Absolute asymmetric synthesis.** Cotton (1896) found that dextro- and lævocircularly polarised light was unequally absorbed by enantiomorphs, provided the light has a wavelength in the neighbourhood of the characteristic absorption bands of the compound. This phenomenon is known as the **Cotton effect** or **circular dichroism** (*cf.* §2. II).

It has been suggested that circularly polarised light produced the first natural active compounds, and to support this theory, racemic modifications have been irradiated with circularly polarised light and attempts made to isolate one enantiomorph. There was very little success in this direction until W. Kuhn and Braun (1929) claimed to have obtained a small rotation in the case of ethyl  $\alpha$ -bromopropionate. The racemic modification of this compound was irradiated with right- and left-circularly polarised light (of wavelength 2800 Å), and the product was found to have a rotation of + or  $-0.05^\circ$ , respectively. Thus we have the possibility of preparing optically active products from inactive substances *without* the intermediate use of optically active reagents (*cf.* Ferreira's work). This type of synthesis is known as an **absolute asymmetric synthesis**; it is also known as an **absolute asymmetric decomposition**. The term asymmetric decomposition is also applied to reactions such as the formation of the (+)- and (-)-forms of  $\alpha\gamma$ -di-1-naphthyl- $\alpha\gamma$ -diphenylallene (see §6. V) by the action of (+)- and (-)-camphorsulphonic acid on the symmetrical alcohol.

From 1930 onward, more conclusive evidence for absolute asymmetric syntheses has been obtained, *e.g.*, W. Kuhn and Knopf (1930) irradiated ( $\pm$ )- $\alpha$ -azidopropionic dimethylamide,  $\text{CH}_3\cdot\text{CHN}_3\cdot\text{CO}\cdot\text{N}(\text{CH}_3)_2$ , with right-circularly polarised light and obtained an undecomposed product with a rotation of  $+0.78^\circ$ ; with left-circularly polarised light, the undecomposed product had a rotation of  $-1.04^\circ$ . Thus the (-)- or (+)-form is decomposed (photochemically) by right- or left-circularly polarised light, respectively. Similarly, Mitchell (1930) irradiated humulene nitrosite with right- and left-circularly polarised red light, and obtained slightly optically active products.

Davis and Heggie (1935) found that the addition of bromine to 2 : 4 : 6-trinitrostilbene in a beam of right-circularly polarised light gave a dextro-rotatory product.

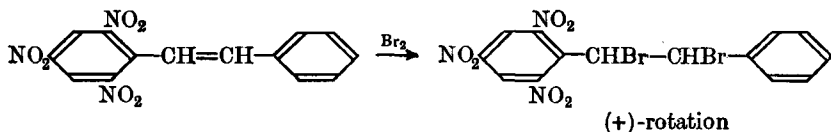

Small (+)-rotations were also observed when a mixture of ethyl fumarate and anhydrous hydrogen peroxide in ethereal solution was irradiated with right-circularly polarised light (Davis *et al.*, 1945).

## READING REFERENCES

- Hinshelwood, *The Kinetics of Chemical Change*, Oxford Press (1940, 4th ed.).
- Moelwyn-Hughes, *The Kinetics of Reactions in Solutions*, Oxford Press (1947, 2nd ed.).
- Glasstone, Laidler and Eyring, *The Theory of Rate Processes*, McGraw-Hill (1941).
- Frost and Pearson, *Kinetics and Mechanism*, Wiley (1961, 2nd ed.).
- Friess and Weissberger (Ed.), *Technique of Organic Chemistry*, Interscience Publishers. Vol. 8 (1953). Investigation of Rates and Mechanisms of Reactions.
- Ingold, *Structure and Mechanism in Organic Chemistry*, Bell and Sons (1953).
- Hine, *Physical Organic Chemistry*, McGraw-Hill (1962, 2nd ed.).
- Gould, *Mechanism and Structure in Organic Chemistry*, Holt and Co. (1959).
- Streitwieser, Solvolytic Displacement Reactions at Saturated Carbon Atoms, *Chem. Reviews*, 1956, **56**, 571.
- Bethell and Gold, The Structure of Carbonium Ions, *Quart. Reviews (Chem. Soc.)*, 1958, **12**, 173.
- Casapieri and Swart, Concomitant First- and Second-order Nucleophilic Substitution, *J.C.S.*, 1961, 4342.
- Hudson *et al.*, Nucleophilic Reactivity, *J.C.S.*, 1962, 1055, 1062, 1068.
- Ritchie, *Asymmetric Synthesis and Asymmetric Induction*, St. Andrews University Press (1933).
- Ritchie, Recent Views on Asymmetric Synthesis and Related Processes, *Advances in Enzymology*, Interscience Publishers, 1947, **7**, 65.
- Cram and Kopecky, Models for Steric Control of Asymmetric Induction, *J. Amer. Chem. Soc.*, 1959, **81**, 2748.
- Klyne (Ed.), *Progress in Stereochemistry*, Butterworth (1954). Ch. 3. Stereochemical Factors in Reaction Mechanisms and Kinetics. Vol. II (1958). Chh. 2, 3.



CHAPTER IV  
GEOMETRICAL ISOMERISM

§1. **Nature of geometrical isomerism.** Maleic and fumaric acids both have the same molecular formula  $C_4H_4O_4$ , but differ in most of their physical and in many of their chemical properties, and neither is optically active. It was originally thought that these two acids were structural isomers; this is the reason for different names being assigned to each form (and to many other geometrical isomers). It was subsequently shown, however, that maleic and fumaric acids were not structural isomers, *e.g.*, both (i) are catalytically reduced to succinic acid; (ii) add one molecule of hydrogen bromide to form bromosuccinic acid; (iii) add one molecule of water to form malic acid; (iv) are oxidised by alkaline potassium permanganate to tartaric acid (the *stereochemical* relationships in reactions (ii), (iii) and (iv) have been ignored; they are discussed later in §5a). Thus both acids have the same structure, *viz.*,  $CO_2H \cdot CH : CH \cdot CO_2H$ . van't Hoff (1874) suggested that if we assume there is *no free rotation about a double bond*, two spatial arrangements are possible for the formula  $CO_2H \cdot CH : CH \cdot CO_2H$ , and these would account for the isomerism exhibited by maleic and fumaric acids. Using tetrahedral diagrams, van't Hoff represented a double bond by placing the tetrahedra edge to edge (Fig. 1). From a *mechanical* point of view, such

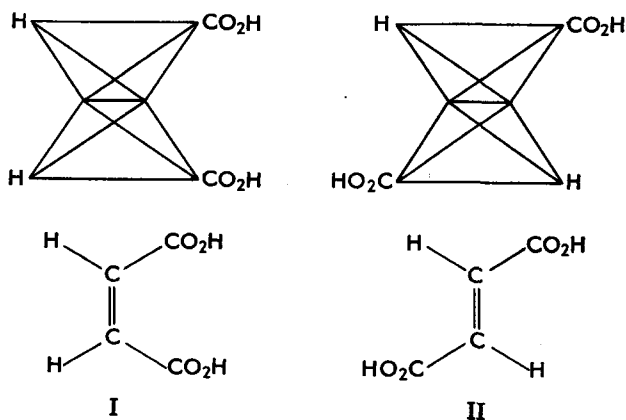

FIG. 4.1.

an arrangement would be rigid, *i.e.*, free rotation about the double bond is not to be expected. Furthermore, according to the above arrangement, the two hydrogen atoms and the two carboxyl groups are all in one plane, *i.e.*, the molecule is flat. Since a flat molecule is superimposable on its mirror image, maleic and fumaric acids are therefore not optically active (§2. II). As we shall see later, modern theory also postulates a planar structure for these two acids, but the reasons are very much different from those proposed by van't Hoff as described above (see also §3a. V).

The type of isomerism exhibited by maleic and fumaric acids is known as **geometrical isomerism** or ***cis-trans* isomerism**. One isomer is known as the *cis*-compound, and the other as the *trans*, the *cis*-compound being the one which (usually) has identical or similar atoms or groups, on the *same side* (see also §4). Thus molecule I is *cis*-butenedioic acid, and II is

*trans*-butenedioic acid. As will be shown later (§5), I is maleic acid and II fumaric acid.

Geometrical isomerism is exhibited by a wide variety of compounds, and they may be classified into three groups:

- (i) Compounds containing a double bond: C=C, C=N, N=N.
- (ii) Compounds containing a cyclic structure—homocyclic, heterocyclic and fused ring systems.
- (iii) Compounds which may exhibit geometrical isomerism due to restricted rotation about a single bond (see §3. V for examples of this type).

**§2. Rotation about a double bond.** We have already seen that, theoretically, there is always some opposition to rotation about a *single* bond and that, in many cases, the opposition may be great enough to cause the molecule to assume some preferred conformation (§4a. II). When we consider the problem of rotation about a *double* bond, we find that there is always considerable opposition to the rotation. Let us first consider the simple case of ethylene; Fig. 2 (a) shows the energy changes in the molecule when one methylene group is rotated about the carbon-carbon double bond with the other methylene group at rest. Thus there are two *identical* favoured positions (one at 0° and the other at 180°), and the potential energy barrier is 40 kg.cal./mole. The examination of many olefinic compounds has shown that the potential energy barrier for the C=C bond varies with the nature of the groups attached to each carbon, e.g.,

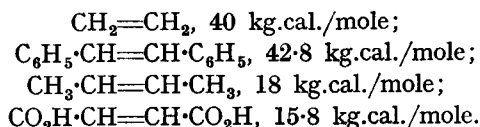

Let us consider the case of maleic and fumaric acids in more detail. It can be seen from the diagram (Fig. 2 b) that there are *two* favoured positions, with the *trans*-form more stable than the *cis*, the energy difference between the two being 6–7 kg.cal./mole. The conversion of the *trans* to the *cis* requires 15·8 kg.cal. energy, but the reverse change requires about 10 kg.cal. (see also §6 for a further discussion of *cis-trans* isomerisation).

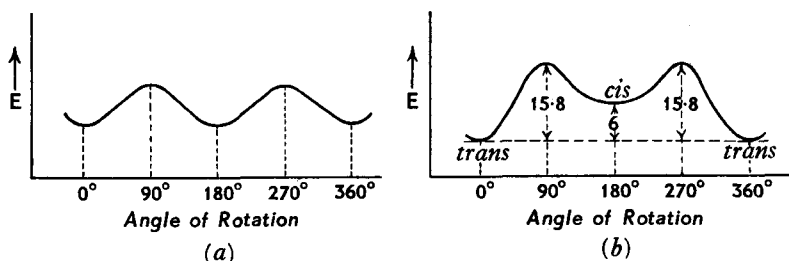

FIG. 4.2.

**§3. Modern theory of the nature of double bonds.** In the foregoing account of geometrical isomerism, the distribution of the carbon valencies was assumed to be tetrahedral (as postulated by van't Hoff). According to modern theory, the four valency bonds of a carbon atom are distributed tetrahedrally only in *saturated* compounds. In such compounds the carbon is in a state of *tetrahedral hybridisation*, the four  $sp^3$  bonds being referred to as  $\sigma$ -bonds (see Vol. I, Ch. II). In olefinic compounds, however, the two carbon atoms exhibit the *trigonal* mode of hybridisation. In this condition there are three coplanar valencies (three  $\sigma$ -bonds produced from  $sp^2$  hybrid-

isation), and the fourth bond ( $\pi$ -bond) at right angles to the trigonal hybrids (Fig. 3).  $\pi$ -Bonds, which appear to be weaker than  $\sigma$ -bonds, tend to overlap as much as possible in order to make the bond as strong as possible. Maximum overlap is achieved when the molecule is planar, since in this configuration the two  $p_z$  orbitals are parallel. Distortion of the molecule from the planar configuration decreases the overlap of the  $\pi$ -electrons, thereby weakening the  $\pi$ -bond; and this distortion can only be effected by supplying energy to the molecule. It is therefore this tendency to produce **maximum overlap of the  $\pi$ -electrons in the  $\pi$ -bond** that gives rise to resistance

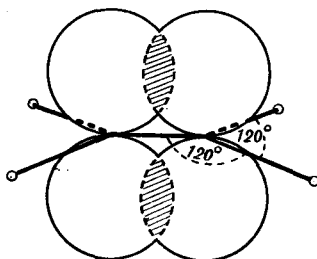

FIG. 4.3.

of rotation about a "double" bond. For simplicity we shall still represent a "double" bond by the conventional method, *e.g.*,  $C=C$ , but it should always be borne in mind that *one* of these bonds is a  $\sigma$ -bond ( $sp^2$  bond), and the *other* is a  $\pi$ -bond perpendicular to the  $\sigma$ -bond. It is these  $\pi$ -electrons (*mobile electrons*) which undergo the electromeric and resonance effects. They are held less firmly than the  $\sigma$ -electrons and are more exposed to external influences; it is these  $\pi$ -electrons which are responsible for the high reactivity of unsaturated compounds.

In compounds containing a triple bond, *e.g.*, acetylene, the two carbon atoms are in a state of *digonal* hybridisation; there are two  $\sigma$ -bonds ( $sp$  bonds) and two  $\pi$ -bonds (one  $p_y$  and one  $p_z$  orbital), both perpendicular to the  $\sigma$ -bonds which are collinear (see Vol. I, Ch. II).

The above treatment of the double (and triple) bond is in terms of  $sp^2$  (and  $sp$ ) hybridisation and  $\pi$ -bonds. It is still possible, however, to use  $sp^3$  hybridisation to describe carbon-carbon multiple bonds; this treatment gives rise to "banana-shaped" orbitals, *i.e.*, "bent" bonds (Fig. 4; see also Vol. I):

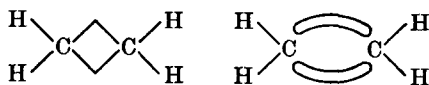
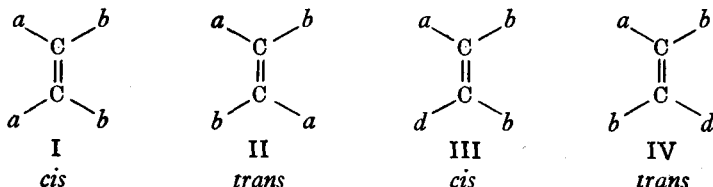

FIG. 4.4

This method of approach still produces a "rigid" molecule, and so again there is no free rotation about the double bond.

**§4. Nomenclature of geometrical isomers.** When geometrical isomerism is due to the presence of *one* double bond in a molecule, it is easy to name the geometrical isomers if two groups are identical, *e.g.*, in molecules I and II, I is the *cis*-isomer, and II the *trans*; similarly III is *cis*, and IV is *trans*. When, however, all four groups are different, nomenclature is more difficult. In this case it has been suggested that the prefixes *cis* and *trans* should indicate the disposition of the *first two* groups named, *e.g.*, the two stereoisomers of 1-bromo-1-chloro-2-iodoethylene, V and VI; V is *cis*-1-bromo-2-iodo-1-chloroethylene or *trans*-1-chloro-2-iodo-1-bromo-ethylene;

VI is *cis*-1-chloro-2-iodo-1-bromoethylene or *trans*-1-bromo-2-iodo-1-chloroethylene. On the other hand, since this method of nomenclature usually deviates from the rule of naming groups in alphabetical order, it has been



suggested that the groups corresponding to the prefix *cis* or *trans* should be italicised, thus V may be named *cis*-1-bromo-1-chloro-2-iodoethylene and VI *trans*-1-bromo-1-chloro-2-iodoethylene. This method, it must be admitted, would offer difficulties when the names are spoken.

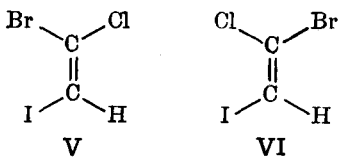

Some pairs of geometrical isomers have trivial names, *e.g.*, maleic and fumaric acids, angelic and tiglic acids, etc. (*cf.* §1). Sometimes the prefix *iso* has been used to designate the *less* stable isomer, *e.g.*, crotonic acid (*trans*-isomer) and *isocrotonic* acid (*cis*-isomer; the *cis*-isomer is usually the less stable of the two; see §2). The use of *iso* in this connection is undesirable since it already has a specific meaning in the nomenclature of alkanes. The prefix *allo* has also been used to designate the less stable isomer (*cis*), *e.g.*, *allocinnamic* acid.

When geometrical isomers contain two or more double bonds, nomenclature may be difficult, *e.g.*, VII. In this case the compound is considered

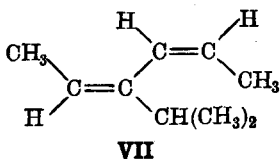

as a derivative of the longest chain which contains the maximum number of double bonds, the prefixes *cis* and *trans* being placed before the numbers indicating the positions of the double bonds to describe the relative positions of the carbon atoms in the main chain; thus VII is 3-*isopropyl*hexa-*cis*-2 : *cis*-4-diene.

If a compound has two double bonds, *e.g.*,  $\text{CH}a=\text{CH}-\text{CH}=\text{CH}b$ , four geometrical isomers are possible:

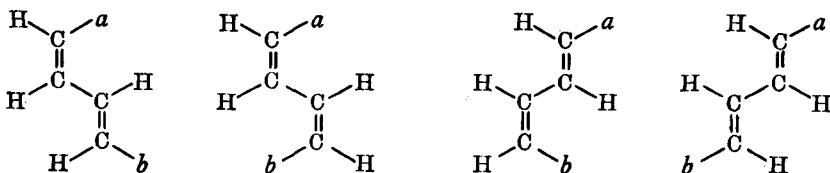

The number of geometrical isomers is  $2^n$ , where  $n$  is the number of double bonds; this formula applies only to molecules in which the ends are different. If the ends are identical, *e.g.*,  $\text{CH}a=\text{CH}-\text{CH}=\text{CH}a$ , then the number of stereo-

isomers is  $2^{n-1} + 2^{p-1}$ , where  $p = n/2$  when  $n$  is even, and  $p = \frac{n+1}{2}$  when  $n$  is odd (Kuhn *et al.*, 1928).

§5. **Determination of the configuration of geometrical isomers.** There is no general method for determining the configuration of geometrical isomers. In practice one uses a number of different methods, the method used depending on the nature of the compound in question. The following are methods which may be used mainly for compounds that owe their geometrical isomerism to the presence of a double bond, but several of the methods are special to geometrical isomers possessing a cyclic structure (see also §7).

(i) **Method of cyclisation.** Wislicenus was the first to suggest the principle that *intramolecular* reactions are more likely to occur the closer together the reacting groups are in the molecule. This principle appears always to be true for reactions in which *rings* are formed, but does not hold for elimination reactions in which a double (or triple) bond is produced [see, *e.g.*, (xi)].

(a) Of the two acids maleic and fumaric, only the former readily forms a cyclic anhydride when heated; the latter does not form an anhydride of its own, but when strongly heated, gives maleic anhydride. Thus I is maleic acid, and II is fumaric acid.

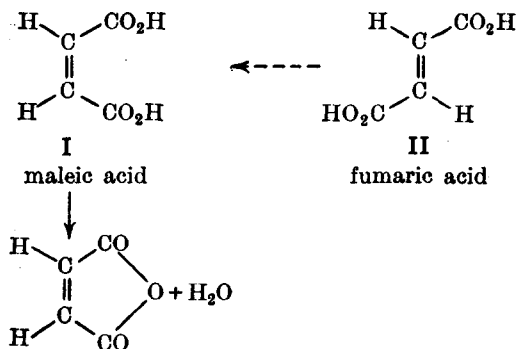

Cyclisation reactions must be performed carefully, since one isomer may be converted into the other during the cyclising process, and so lead to unreliable results. In the above reaction, somewhat vigorous conditions have been used; hence there is the possibility that interconversion of the stereoisomers has occurred. Since maleic acid cyclises readily, and fumaric acid only after prolonged heating, the former is most probably the *cis*-isomer, and the latter the *trans* which forms maleic anhydride *via* the formation of maleic acid (see also §6). The correctness of the conclusion for the configurations of the two acids may be tested by hydrolysing maleic anhydride in the cold; only maleic acid is obtained. Under these mild conditions it is most unlikely that interconversion occurs, and so we may accept I as the configuration of maleic acid.

(b) Citraconic acid forms a cyclic anhydride readily, whereas the geometrical isomer, mesaconic acid, gives the same anhydride but much less readily. Thus these two acids are:

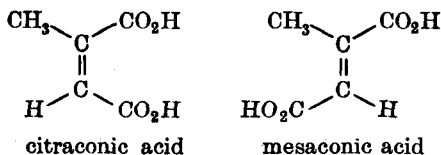

(c) There are two *o*-hydroxycinnamic acids, one of which spontaneously forms the lactone, coumarin, whereas the other does not. Thus the former is the *cis*-isomer, coumarinic acid, and the latter the *trans*-isomer, coumaric acid.

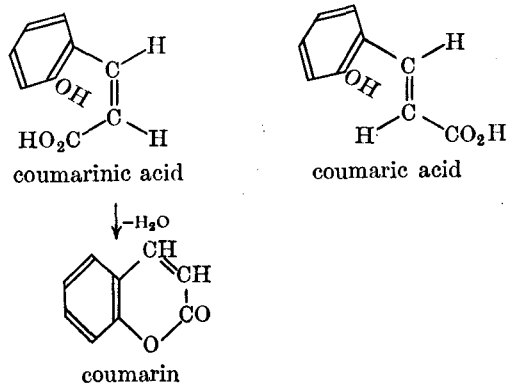

(d) Two forms of hexahydroterephthalic acid are known, one of which forms a cyclic anhydride, and the other does not. Thus the former is the *cis*-isomer, and the latter the *trans* (see also §§9, 11).

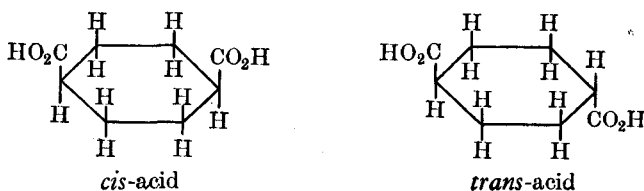

(ii) **Method of conversion into compounds of known configuration.**

In a number of cases it is possible to determine the configurations of pairs of geometrical isomers by converting them into compounds the configurations of which are already known. As an example of this type let us consider the two forms of crotonic acid, one of which is known as crotonic acid (m.p.  $72^\circ$ ), and the other as *isocrotonic acid* (m.p.  $15.5^\circ$ ). Now there are two trichlorocrotonic acids, III and IV, one of which can be hydrolysed to fumaric acid. Therefore this trichlorocrotonic acid must be the *trans*-isomer, III; consequently the other is the *cis*-isomer IV. Both these tri-

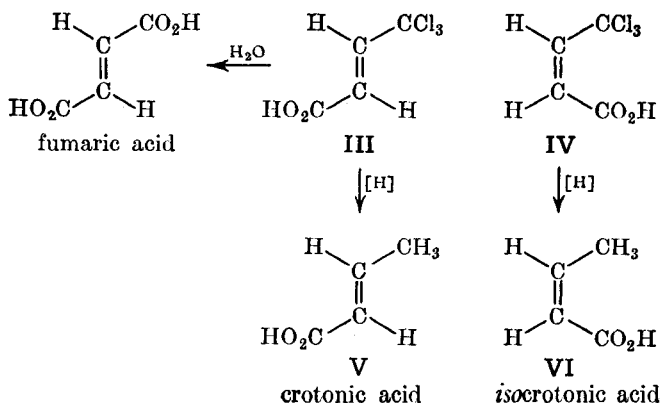

chlorocrotonic acids may be reduced by sodium amalgam and water, or by zinc and acetic acid, to the crotonic acids, III giving crotonic acid, V, and IV giving *isocrotonic acid*, VI. Thus crotonic acid is the *trans*-isomer, and *isocrotonic* the *cis* (von Auwers *et al.*, 1923).

(iii) **Method of conversion into less symmetrical compounds.**

Certain pairs of geometrical isomers may be converted into less symmetrical compounds in which the number of geometrical isomers is increased, and by considering the number of products obtained from each original stereoisomer, it is possible to deduce the configurations of the latter. *E.g.*, there are two 2:5-dimethylcyclopentane-1:1-dicarboxylic acids, and these, on heating, are decarboxylated to 2:5-dimethylcyclopentane-1-carboxylic acid. Consideration of the following chart shows that the *cis*-form of the original dicarboxylic acid can give rise to *two* stereoisomeric monocarboxylic acids, whereas the *trans*-form can produce only *one* product. Thus the configurations of the dicarboxylic acids are determined (see also §10).

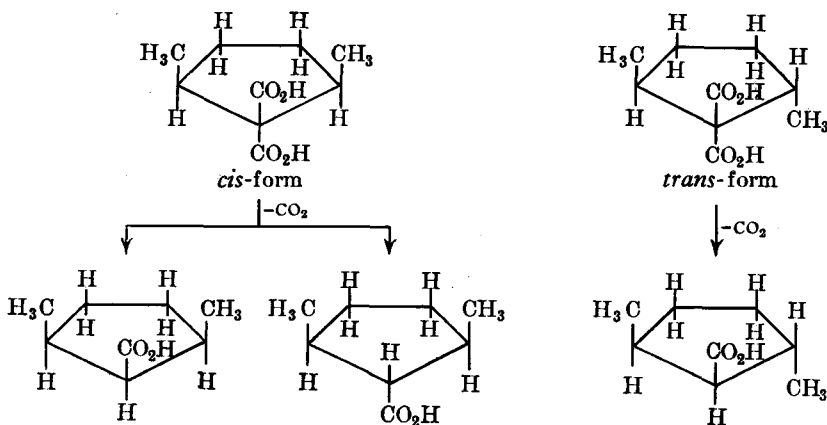

(iv) **Method of optical activity.** In many pairs of geometrical isomers one form may possess the requirements for optical activity (§2. II), whereas the other form may not. In such cases a successful resolution of one form will determine the configuration, *e.g.*, there are two hexahydrophthalic acids; the *cis*-form possesses a plane of symmetry and consequently is optically inactive. The *trans*-form, however, possesses no elements of symmetry, and so should be resolvable; this has actually been resolved (see also §11).

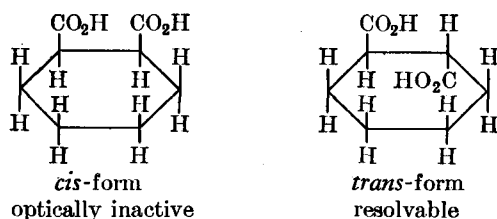

(v) **Method of dipole moments.** The use of dipole moments to assign configurations to geometrical isomers must be used with caution. The method is satisfactory so long as the groups attached to the olefinic carbon atoms have linear moments (see §13. I), *e.g.*, *cis*-1,2-dichloroethylene has a dipole moment of 1.85 D; the value of the dipole moment of the *trans* isomer is zero. When, however, the groups have non-linear moments, then the vector sum in the *trans*-isomer will no longer be zero and the difference

between the dipole moments of the *cis*- and *trans*-isomers may be too small to assign configuration with any confidence, *e.g.*, the dipole moment of diethyl maleate is 2.54 D and that of diethyl fumarate is 2.38 D.

(vi) **X-ray analysis method.** This method of determining the configuration of geometrical isomers is probably the best where it is readily applicable (see also §16. I).

(vii) **Ultraviolet, visible, infra-red, Raman, and NMR spectra methods.** Geometrical isomers may show different spectra, *e.g.*, the intensity of the band in the ultraviolet absorption spectrum depends on the dipole moment (see Vol. I, Ch. XXXI), and this, in turn, depends on the distance between the charges. In the *trans*-form of a *conjugated* molecule, the distance between the ends is greater than that in the *cis*-form. Consequently the intensity of absorption of the *trans*-form is greater than that of the *cis* (see also §15. I). Thus, in cases such as these, it is possible to assign configurations to pairs of geometrical isomers.

NMR spectra (§19a. I) have recently been used to determine configurations of geometrical isomers, *e.g.*, Curtin *et al.* (1958) have used this method to distinguish between the *cis*- and *trans*-isomers of stilbene and azobenzene; Musher *et al.* (1958) have assigned configurations to *cis*- and *trans*-decalin [§11(vii)].

(viii) **Method of surface films.** Long-chain geometrical isomers which contain a terminal group capable of dissolving in a solvent will form surface films, but only the *trans*-form can form a close-packed film, *e.g.*, the long-chain unsaturated fatty acids.

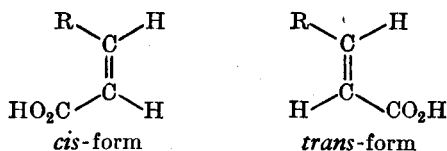

(ix) **Method of formation of solid solutions.** In compounds which owe their property of geometrical isomerism to the presence of an olefinic bond, the shape of the *trans*-form is similar to that of the corresponding saturated compound, whereas that of the *cis*-form is different, *e.g.*, the shapes of fumaric and succinic acids are similar, but the shape of maleic acid is different from that of succinic acid. Now molecules which are approximately

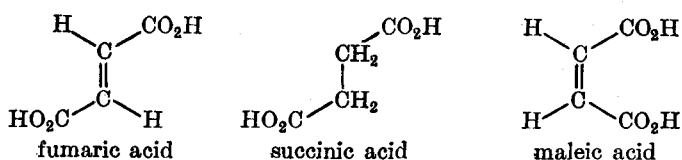

of the same size and shape tend to form solid solutions. Thus fumaric acid forms a solid solution with succinic acid, whereas maleic acid does not; hence the configurations of maleic and fumaric acids may be determined.

(x) **Methods based on generalisations of physical properties.** Comparison of the physical properties of geometrical isomers of known configurations has led to the following generalisations:

(a) The melting point and intensity of absorption of the *cis*-isomer are lower than those of the *trans*.

(b) The boiling point, solubility, heat of combustion, heat of hydrogenation, density, refractive index, dipole moment and dissociation constant (if the compound is an acid) of the *cis*-isomer are greater than those of the *trans*.

Based on certain of these generalisations is the **Auwers-Skita rule** (1915, 1920), *viz.*, in a pair of *cis-trans* isomers (of alicyclic compounds), the *cis*





(xi) **Method of stereospecific addition and elimination reactions.** This method for determining the configurations of geometrical isomers is based on the assumption that addition reactions to a double or triple bond always occur in a definite manner—either *cis* or *trans*—for a given addendum under given conditions. Similarly, elimination reactions are also assumed to take place in a definite manner.

(a) **Conversion of acetylenic compounds into ethylenic compounds, and vice versa.** This problem was first studied by Wislicenus (1887), who suggested that when one of the acetylenic bonds is broken, the two groups of the addendum should add on in the *cis*-position, *e.g.*, the addition of bromine to acetylenedicarboxylic acid should produce dibromomaleic acid.

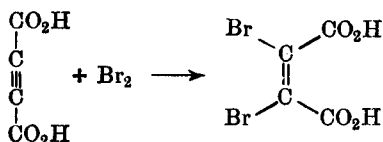

In practice, however, a mixture of dibromofumaric and dibromomaleic acids is obtained, with the former predominating. Similarly, halogen acids add on to give mainly halogenofumaric acid. Thus, in these two examples, the suggestion of Wislicenus is incorrect. On the other hand, the reduction of tolan with zinc dust and acetic acid (Rabinovitch *et al.*, 1953) produces *isostilbene* (the *cis*-compound):

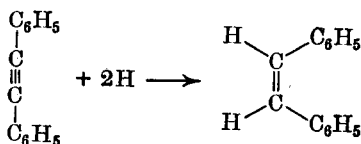

This is a *cis*-addition, but the problem of reduction of a triple bond is complicated by the fact that the results depend on the nature of the compound and the conditions used, *e.g.*, Fischer (1912) found that phenylpropionic acid on catalytic reduction gave *cis*-cinnamic acid, whereas on reduction with zinc dust and acetic acid, *trans*-cinnamic acid was obtained.

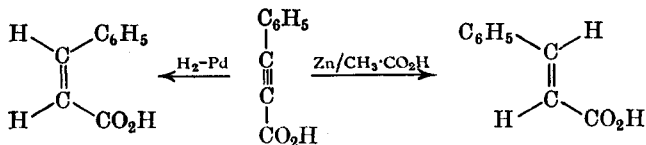

Benkeser *et al.* (1955), on the other hand, have shown that the reduction of acetylenes with lithium in aliphatic amines of low molecular weight produces *trans*-olefins. It appears that, in general, chemical reduction produces the *trans*-olefin, whereas catalytic hydrogenation produces the *cis*-olefin. As a result of a large amount of experimental work, it has been found that addition reactions to a triple bond where the addenda are halogens or halogen acids produce predominantly the *trans*-ethylenic compound, and so, using this generalisation, one can determine the configurations of geometrical isomers when prepared from acetylenic compounds (provided, of course, the addenda are halogen or halogen acid).

Wislicenus also supposed that removal of halogen, halogen acid, etc., from olefinic compounds to produce acetylenic compounds was easier in the *cis*-position than in the *trans*. This again was shown to be incorrect experimentally, and thus the elimination reaction may be used to determine

configuration if the assumption is made that *trans*-elimination occurs more readily than *cis* (see also oximes, §2f. VI).

(b) **Conversion of ethylenic compounds into ethane derivatives, and vice versa.** Just as it was assumed that the addition of halogens and halogen acids to a triple bond takes place in the *cis*-position, so the same assumption was made with respect to the double bond. Thus the addition of bromine to maleic acid should give *meso*- $\alpha : \alpha'$ -dibromosuccinic acid. Configurations VII (formed by attack from *behind* the molecule) and VIII

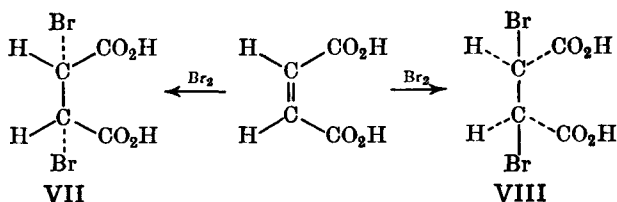

(formed by attack in *front*) are identical, both being the same *meso*-dibromosuccinic acid. Similarly fumaric acid would be expected to give ( $\pm$ )- $\alpha : \alpha'$ -dibromosuccinic acid. IX and X are mirror images, and since they will be

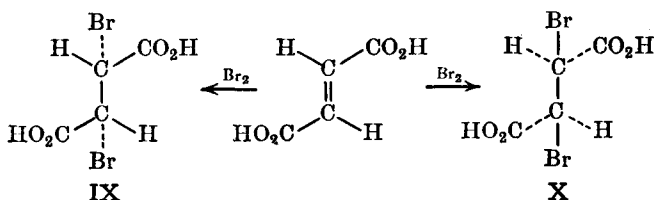

formed in equal amounts (see §7a. II), the racemic modification is produced. Experimental work, however, has shown that the reverse is true, *i.e.*, maleic acid gives mainly ( $\pm$ )-dibromosuccinic acid (IX and X), and fumaric acid gives mainly *meso*dibromosuccinic acid (VII). Thus the addition of bromine must be *trans*. In the same way it has been shown that the addition of halogen acid is also *trans*. Hence, assuming *trans*-addition always occurs with these addenda, the nature of the products indicates the configuration of the ethylenic compound.

The configuration of the product formed by hydroxylation of a double bond depends on the nature of the hydroxylating agent used and on the conditions under which the reaction is carried out. Permanganate and osmium tetroxide apparently always give *cis*-addition, whereas permono-sulphuric acid (Caro's acid) and perbenzoic acid give *trans*-addition. On

Reagent	Type of addition	Maleic acid	Fumaric acid
KMnO <sub>4</sub> . . . . .	<i>cis</i>	<i>mesotartaric acid</i>	DL-tartaric acid
OsO <sub>4</sub> . . . . .	<i>cis</i>	<i>mesotartaric acid</i>	DL-tartaric acid
H <sub>2</sub> SO <sub>5</sub> . . . . .	<i>trans</i>	DL-tartaric acid	<i>mesotartaric acid</i>
C <sub>6</sub> H <sub>5</sub> ·CO·O <sub>2</sub> H . . . . .	<i>trans</i>	DL-tartaric acid	<i>mesotartaric acid</i>
H <sub>2</sub> O <sub>2</sub> —OsO <sub>4</sub> . . . . .	<i>cis</i>	<i>mesotartaric acid</i>	DL-tartaric acid
H <sub>2</sub> O <sub>2</sub> —SeO <sub>2</sub> . . . . .	<i>trans</i>	DL-tartaric acid	<i>mesotartaric acid</i>

the other hand, hydroxylation with hydrogen peroxide catalysed by osmium tetroxide in *tertiary*-butanol gives *cis*-addition; if the reaction is catalysed by selenium dioxide in *tertiary*-butanol or in acetone, then the addition is *trans* (see also below). The table above shows the products formed by hydroxylation of maleic and fumaric acids.



and osmium tetroxide the *cis*-addition is readily explained by assuming the formation of a cyclic organo-metallic intermediate.

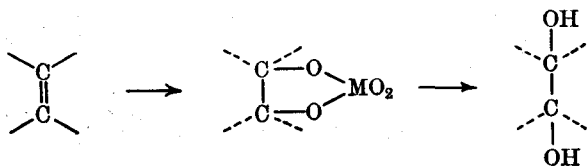

This cyclic intermediate is definitely known in the case of osmium tetroxide (see Vol. I); for potassium permanganate it may be assumed that the permanganate ion,  $\text{MnO}_4^-$  (or the manganate ion,  $\text{MnO}_4^{2-}$ ), behaves in a similar manner. This is supported by the work of Wiberg *et al.* (1957), who used potassium permanganate labelled with  $^{18}\text{O}$  and showed that *both* glycol oxygen atoms come from the permanganate ion. This also indicates that fission of the cyclic compound occurs between the O and Mn atoms.

With per-acids the hydroxylation results in *trans*-addition. The first product of oxidation is an epoxide (Prileschaiev reaction; see Vol. I). Evidence from kinetic studies on solutions of epoxides under high pressure strongly suggests that acid-catalysed hydrolysis is a bimolecular substitution of the conjugate acid (Whalley *et al.*, 1959). This will result in *trans*-hydroxylation. Thus:

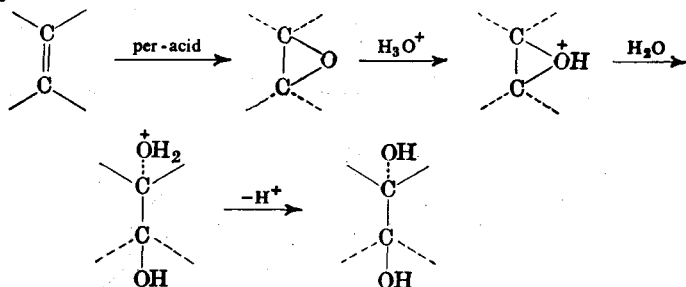

The addition of hydrogen peroxide may result in *cis* or *trans* compounds. Which occurs depends on the conditions of the experiment, *e.g.*, the catalyst (see above). Where *trans*-addition occurs, the mechanism may possibly be through the epoxide, but a free hydroxyl radical mechanism could also result in the *trans*-glycol. *Cis*-addition in the presence of certain oxides probably occurs *via* a cyclic intermediate.

The addition of a dienophile to a diene in the Diels-Alder reaction is stereospecific; *cis*-addition always occurs (see Vol. I). Since it is usually possible to determine the configuration of the cyclic adduct, this offers a means of ascertaining the configuration of the dienophile. *E.g.*, butadiene forms adducts with *cis*- and *trans*-cinnamic acids, and hence determination of the configurations of the stereoisomeric adducts will determine the configurations of the cinnamic acids (see §11); thus:

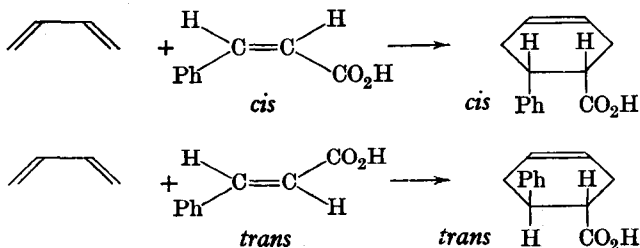

**§5b. Stereochemistry of elimination reactions.** The mechanisms of elimination in alkyl halides and onium salts have been discussed in Vol. I (Ch. V, XIII, XIV). Here we shall deal mainly with the stereochemical aspects of elimination reactions. In olefin-forming eliminations, two mechanisms are possible, E1 and E2, *e.g.*,

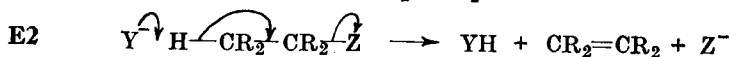
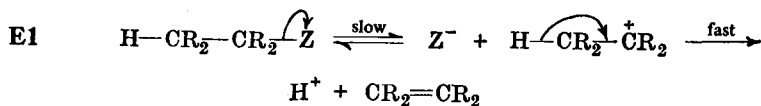

Many examples in the literature show that *trans* elimination occurs more readily than *cis*, *e.g.* (also see later):

(a) Michael (1895) showed that reaction 1 was about 50 times as fast as 2.

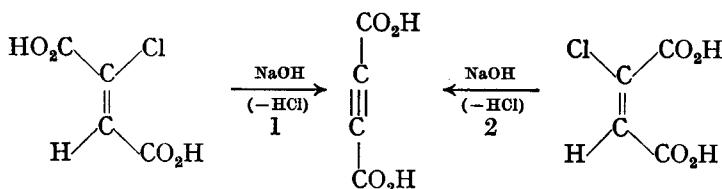

(b) Chavanne (1912) showed that reaction 1 was about 20 times as fast as 2.

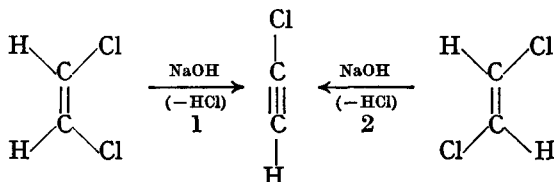

(c) Cristol (1947) showed that the  $\beta$ -isomer of hexachlorocyclohexane underwent base-catalysed elimination with great difficulty, whereas under the same conditions all the other known isomers (four at that time; see also §11) readily underwent second-order elimination to form trichlorobenzenes; the  $\beta$ -isomer is the only one in which *all* the 1,2-HCl pairs are *cis*. Thus in the E2 reaction, the *trans* requirement is necessary (see also below).

According to Hughes and Ingold, bimolecular elimination reactions (E2) take place when the two groups (to be eliminated) are *trans* and the groups

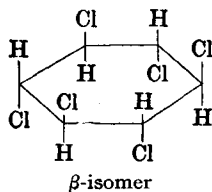

and the two carbon atoms (to which the groups are attached) *all lie in one plane*. In this way the planar transition state will be readily formed. As the proton is being removed from the  $\beta$ -carbon atom by the base, the

“liberated” covalent pair of electrons attacks the  $\alpha$ -carbon atom from the rear, thereby forming the double bond with displacement of the halogen atom. This type of sequence is not possible when the  $\beta$ -hydrogen atom is *cis* to the halogen atom.

Before discussing olefin-forming eliminations, let us consider acetylenic-forming eliminations. As already pointed out above, the elimination has been found to occur more readily in the *trans*-isomer than in the *cis*. This may be explained by assuming that the elimination occurs by the E2 mechanism:

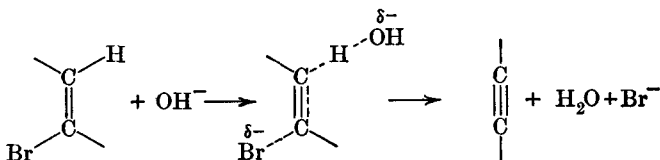

Now let us consider eliminations in ethane derivatives to form ethylene derivatives, *e.g.*, the debromination of 2:3-dibromobutane by means of potassium iodide in acetone solution. Winstein *et al.* (1939) showed that this reaction is bimolecular (first order in dibromide and first order in iodide ion). Thus, in the transition state, the two carbons (of the CBr groups) and the two bromine atoms will all lie in the same plane and at the same time the two bromine atoms will be in the staggered position. Now 2:3-dibromobutane exists in (+)-, (-)- and *meso*-forms, and it has been shown that the ( $\pm$ )-form gives *cis*-butene, whereas the *meso*-form gives *trans*-butene. These eliminations may therefore be written as follows (following Winstein *et al.*, 1939; the iodine atom is probably in the same plane as the other four groups involved in the planar transition state):

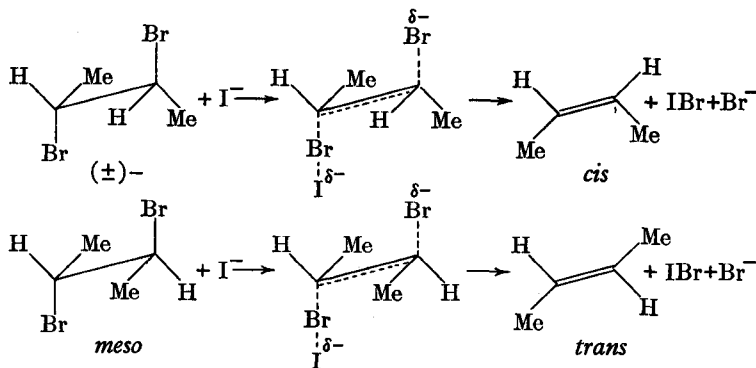

In the ( $\pm$ )-form, as the transition state changes into the ethylene compound, the two methyl groups become eclipsed; in the *meso*-form a methyl group becomes eclipsed with a hydrogen. Thus the energy of activation of the transition state of the ( $\pm$ )-form will be greater than that of the *meso*-form and consequently the latter should be formed more readily, *i.e.*, the *meso*-form should undergo debromination more readily than the ( $\pm$ )-form. Winstein *et al.* (1939) have shown that this is so in practice, the rate of debromination being about twice as fast. These authors also showed that the rate of debromination of *meso*-stilbene dibromide



is about 100 times as fast as that of the ( $\pm$ )-form.

Cram *et al.* (1952) have shown that the base-catalysed dehydrobromination of the diastereoisomeric 1-bromo-1:2-diphenylpropanes (I and II) gives olefins that can only arise by *trans* elimination.

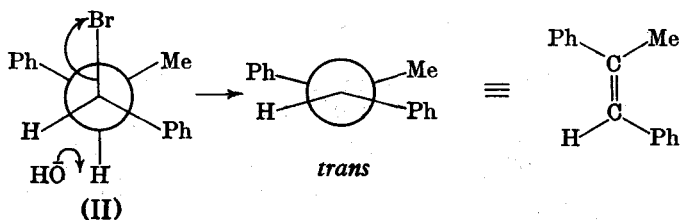
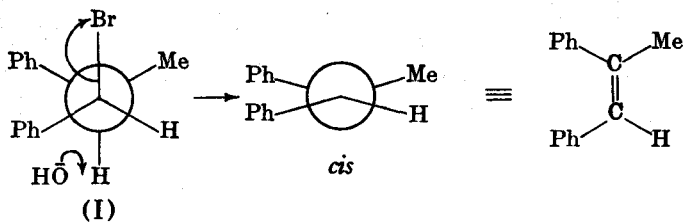

Cram *et al.* (1956) examined the elimination reaction of the following 'onium ion with base:

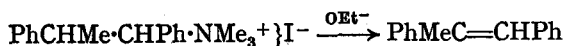

This 'onium ion exists in two forms, *threo* and *erythro*, and the results were that the *threo*-compound gave the *trans*-olefin and the *erythro*-compound

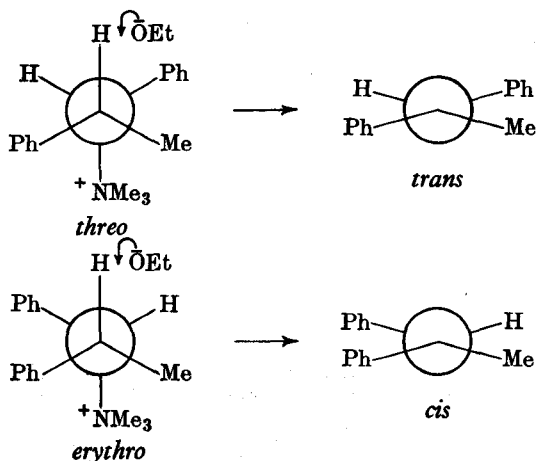

the *cis*-olefin; this is in keeping with *trans* elimination. The rates of elimination, however, were very different, the *threo*-form reacting over 50 times as fast as the *erythro*. In the *cis*-product, the two phenyl groups become eclipsed and hence the energy of activation for this product is greater than that for the *trans*-product, and consequently the latter is formed more readily (see also §12).

An interesting point that now arises is: What is the mechanism when



the two eliminated groups *cannot* assume the *trans*-position? An example of this type is the  $\beta$ -isomer of hexachlorocyclohexane. Cristol (1951, 1953) and Hughes, Ingold *et al.* (1953) have proposed that the first step, which is the rate-determining one, is the formation of a *carbanion*:

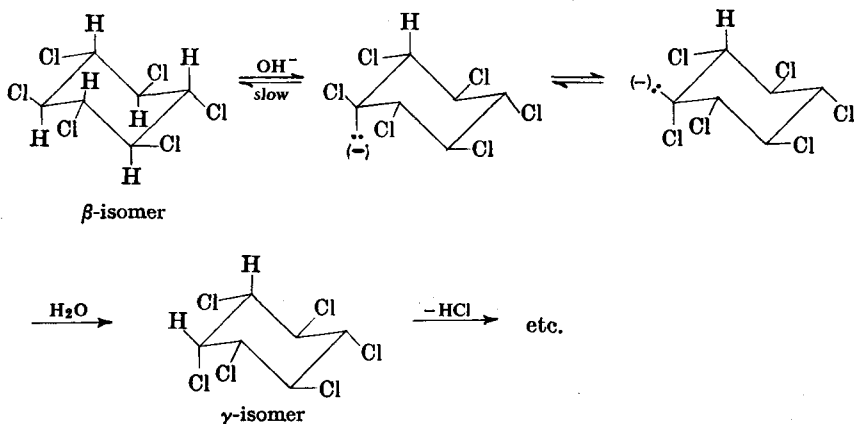

It should be noted that even if the chair form of the  $\beta$ -isomer given above could change to its other chair form, the "ideal" *trans*-position of 1,2-HCl would still not be achieved; the conformations of all hydrogens and chlorines would be reversed. It is possible, however, when *both* groups to be eliminated are equatorial, that both become axial if the ring is sufficiently flexible. Thus the favourable conformation would be produced, but the elimination would be slowed down since energy must be supplied for this conversion. When the two groups cannot assume the favourable *trans*-position, the normal E2 mechanism will not operate. It appears most likely that the elimination then proceeds *via* the formation of carbanions. It is possible, however, that the elimination might proceed by the E1 mechanism (see *trans*-4-*t*-butylcyclohexyl tosylate, §12).

**§6. Interconversion (stereomutation) of geometrical isomers.** The *cis*-isomer, being usually the more labile form, is readily converted into the *trans*-form under suitable physical or chemical conditions. The usual chemical reagents used for stereomutation are halogens and nitrous acid, *e.g.*,

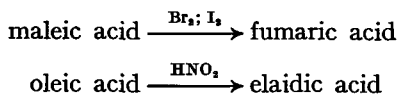

Other methods such as distillation or prolonged heating above the melting point also usually convert the *cis*-isomer into the *trans*, but, in general, the result is a mixture of the two forms.

The conversion of the *trans*-isomer into the *cis* may be effected by means of sunlight, but the best method is to use ultraviolet light in the presence of a trace of bromine.

Many theories have been proposed for the interconversion of geometrical isomers, but none is certain. To effect conversion, the double bond must be "dissociated" so as to allow rotation about the single bond (*i.e.*, the  $\sigma$ -bond; see §3). Let us consider the conversion of maleic acid into fumaric acid under the influence of light and in the presence of a trace of bromine. One mechanism that has been suggested for this change is a free-radical

chain reaction, since the conversion does not appear to be effected by bromine in the dark. Thus:

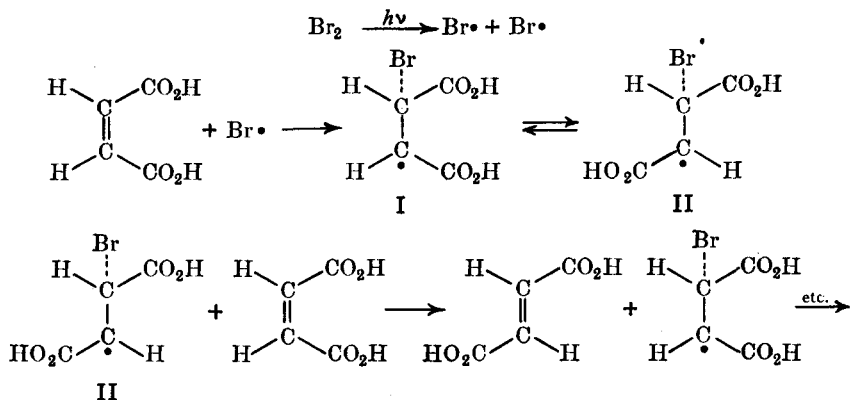

In free radicals I and II, the upper carbon atom is in a state of tetrahedral hybridisation, and the lower one (the free radical part) in a trigonal state (and therefore flat). Owing to the repulsion between the carboxyl groups, configuration I tends to change into configuration II by rotation about the single bond (*cf.* §4. II). If II now reacts with a molecule of maleic acid, the latter is converted into a free radical containing the bromine atom, and II is converted into fumaric acid if "inversion" occurs on the lower carbon atom; if no "inversion" occurs, II would form maleic acid again.

Similarly, various other reagents are also believed to act by a free-radical mechanism, *e.g.*, the conversion of *cis*-stilbene into *trans*-stilbene by means of light in the presence of hydrogen bromide. In the absence of light, the conversion takes place very slowly, but in the presence of oxygen or benzoyl peroxide, the conversion is rapid. These reagents are known to generate free radicals; this supports the free-radical mechanism, the reaction being initiated by the formation of free radicals from the hydrogen bromide. Furthermore, if the reaction is carried out in the presence of benzoyl peroxide and quinol, the conversion of *cis*- into *trans*-stilbene is extremely slow. This is in keeping with the free-radical mechanism, since it is known that quinol removes free radicals.

Boron trifluoride also catalyses the conversion of *cis*- into *trans*-stilbene. In this case the mechanism is less certain, but a reasonable one is:

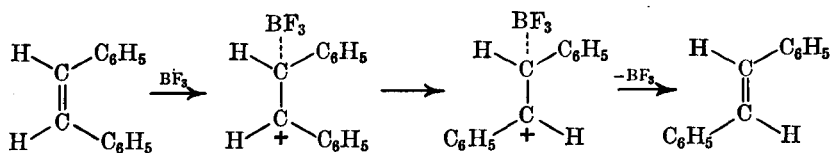

Now let us consider *thermal* interconversion. Kistiakowsky (1935) has shown experimentally that there are at least two mechanisms for thermal *cis-trans* isomerisation of ethylene compounds, and that both are first-order reactions. Experimental results have also shown that one mechanism requires a high and the other a low energy of activation. In the transition state (in both thermal and chemical isomerisations), the two parts of the molecule are perpendicular to each other. To reach this state the double bond, as we have seen, must undergo "dissociation"; this occurs by the decoupling of the  $\pi$ -electrons. The spins of these electrons may remain anti-parallel in the perpendicular (*i.e.*, transition) state. This type of "dis-

sociation" of a double bond requires energy of about 40 kg.cal., and the transition is said to be from a singlet ground state to an upper singlet state. On the other hand, it is also possible for the spins of the  $\pi$ -electrons to be parallel (this state is said to be the triplet state), and the energy required for this "dissociation" is about 25 kg.cal. It has been observed that alkylated ethylenes favour the triplet-state pathway, whereas arylated ethylenes favour the singlet-state pathway (see table in §2).

### §7. STEREOCHEMISTRY OF CYCLIC COMPOUNDS

Geometrical and optical isomerism may exist in any sized ring. In the following account, the saturated rings are treated as rigid flat structures, and the groups attached to the ring-carbon atoms are regarded as being above or below the plane of the ring (see also, in particular, *cyclohexane* compounds, §11). Furthermore, the examples described deal only with those cases in which the asymmetric carbon atoms are part of the saturated ring system. In general, the pattern of optical isomerism followed by cyclic compounds is similar to that of the acyclic compounds. The main difference between the two is that, since there is no free rotation about ring-carbon atoms, geometrical isomerism may therefore be manifested as well as optical isomerism. On the other hand, geometrical isomerism may exist without optical isomerism (see §5 for methods of determination of the configuration of geometrical isomers; see also §§9, 10, 11).

**§8. *cycloPropane* types.** Molecule I contains one asymmetric carbon atom (\*), and is not superimposable on its mirror image molecule II. Thus I and II are enantiomorphs, *i.e.*, a *cyclopropane* derivative containing one

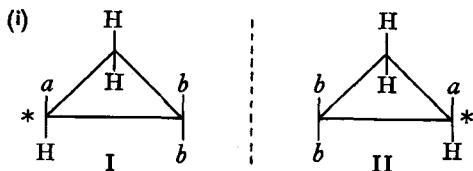

asymmetric carbon atom can exist in two optically active forms (and one racemic modification; *cf.* §7a. II). Molecule III contains two different asymmetric carbon atoms, and since it has no elements of symmetry (§6. II), it is not superimposable on its mirror image molecule. Thus III can exist in two optically active forms (and one racemic modification). Structure III,

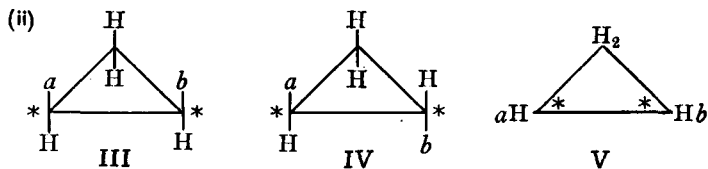

however, is capable of exhibiting geometrical isomerism, the two geometrical isomers being III and IV. Now IV also contains two different asymmetric carbon atoms, and these are not disposed towards each other as in III. Since IV possesses no elements of symmetry, it can also exist in two optically active forms which are different from those of III. Thus V, which may be regarded as the non-committal way of writing the configurations III and IV, is similar, as far as *optical isomerism* is concerned, to the acyclic molecule *Cabd-Cabe*, *i.e.*, there are four optically active forms in all (two pairs of enantiomorphs). In general, any monocyclic system can exist in  $2^n$

optically active forms, where  $n$  is the number of different asymmetric ring-carbon atoms (cf. §7c. II). Molecule VI contains two similar asymmetric

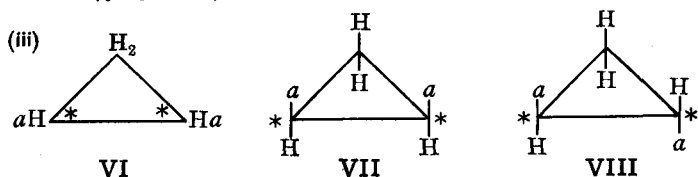

carbon atoms, and can exist as geometrical isomers VII and VIII. VII has a (vertical) plane of symmetry and therefore represents a *meso*-form. VIII, however, possesses no elements of symmetry and can therefore exist in two optically active forms (and one racemic modification). IX contains

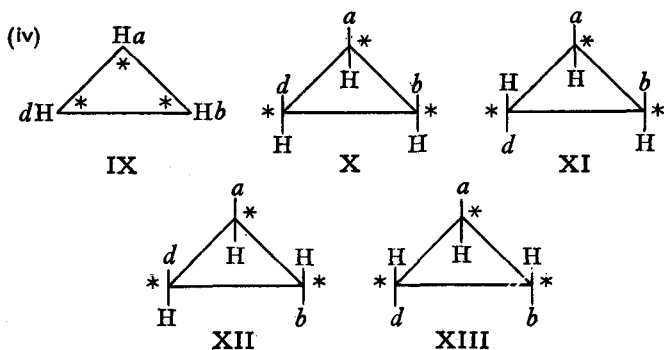

three different asymmetric carbon atoms and can therefore exist in  $2^3 = 8$  optically active forms (four pairs of enantiomorphs). Each pair of enantiomorphs is derived from the *four* geometrical isomers X–XIII. Inspection of these configurations shows that all of them possess no elements of symmetry. XIV contains two similar asymmetric carbon atoms, and the third

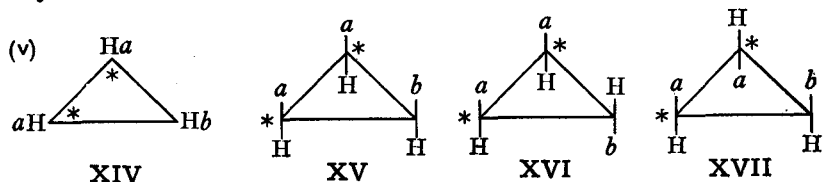

carbon atom is pseudo-asymmetric (cf. §7d. II). Three geometrical isomers, XV–XVII, are possible; XV and XVI each possess a (vertical) plane of symmetry, and therefore each represents a *meso*-form. XVII, however, possesses no elements of symmetry and so can exist in two optically active

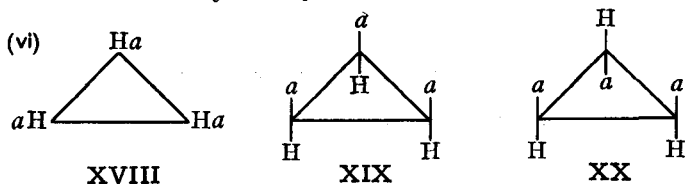

forms (and one racemic modification). XVIII contains three similar asymmetric carbon atoms which are all pseudo-asymmetric. Two geometrical isomers are possible, XIX and XX, both of which possess at least one (vertical) plane of symmetry, and therefore represent *meso*-forms.

In the above account, the stereochemistry of the *cyclopropane* ring has been dealt with from the theoretical point of view, and thus most of the ideas connected with the stereochemistry of monocyclic systems have been described. In the following sections more emphasis is laid on specific examples, and any further points that arise are dealt with in the appropriate section.

**§9. *cycloButane* types.** Two important examples of the *cyclobutane* type are truxillic and truxinic acids; truxillic acid is 2 : 4-diphenyl*cyclobutane*-1 : 3-dicarboxylic acid, and truxinic acid is 3 : 4-diphenyl*cyclobutane*-1 : 2-dicarboxylic acid. *cis*-Cinnamic acid (allocinnamic acid), on irradiation with light, forms mainly  $\beta$ -truxinic acid and *trans*-cinnamic acid, together with some of the dimer of the latter,  $\alpha$ -truxillic acid (de Jong, 1929). Bernstein *et al.* (1943) found that irradiation of commercial *trans*-cinnamic acid gave only  $\beta$ -truxinic acid. When *trans*-cinnamic acid was slowly recrystallised from aqueous ethanol, dried, and then irradiated, only  $\alpha$ -truxillic acid was obtained. Truxillic and truxinic acids have been isolated from natural sources.

**Truxillic acid.** This acid can exist theoretically in five stereoisomeric forms, all of which are known (the acid is of the type I). All five are *meso*-forms, II-V having planes of symmetry, and VI a centre of symmetry. The configurations of these stereoisomers have been assigned as follows. When one of the carboxyl groups is converted into the anilido-group,  $\cdot\text{CONH}\cdot\text{C}_6\text{H}_5$ , two of the five forms give optically active compounds, each giving a pair of enantiomorphs. Now only the stereoisomers with the two

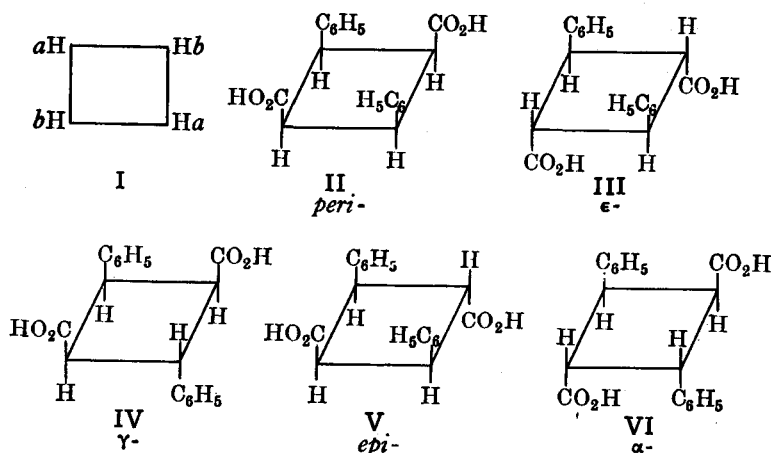

phenyl groups in the *trans*-position can produce asymmetric molecules under these conditions; the remaining forms will each have a (vertical) plane of symmetry. Thus only IV and VI satisfy the necessary conditions. One of these is known as the  $\alpha$ -acid (m.p. 274°) and the other the  $\gamma$ -acid (m.p. 288°). This then raises the problem: Which is which? This is readily answered by the fact that of the anilido-derivatives of these two acids, only one can be dehydrated to a cyclic *N*-phenyl imide,  $\text{—CO—N}(\text{C}_6\text{H}_5)\text{—CO—}$ . This reaction can be expected to take place only when the two carboxyl groups are in the *cis*-position (see §5. i). Therefore IV is  $\gamma$ -truxillic acid, and VI is  $\alpha$ -truxillic acid (since the acid with the melting point 288° has been called the  $\gamma$ -acid). By considering the ease of formation of the cyclic anhydride, the configurations of the remaining three stereoisomers may be determined. Two form anhydrides readily, and therefore one of these acids

must be II and the other III. The third acid does not form its own anhydride, but gives a mixture of the anhydrides produced by II and III. Thus the third acid, *epi-truxillic acid*, is V. The final problem is to decide which of the two, II and III, is *peri-truxillic acid*, and which is  $\epsilon$ -truxillic acid. *peri-Truxillic acid*, under the influence of aluminium chloride, undergoes an internal Friedel-Crafts reaction to form a truxonic acid, VII, and a truxone, VIII. This is only possible when the phenyl and carboxyl groups are in the *cis*-position. Thus II is *peri-truxillic acid*, and therefore III is  $\epsilon$ -truxillic acid.

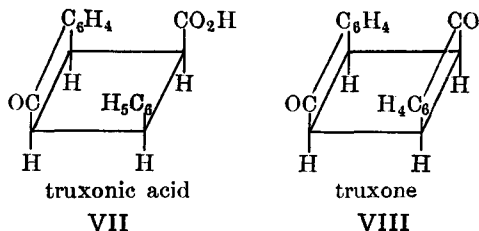

**Truxinic acid.** This acid can exist theoretically in six geometrical isomeric forms, four of which are resolvable; thus ten forms in all are possible theoretically. Truxinic acid is of the type IX, and the six geometrical isomers possible are X–XV. X and XI are *meso*-forms (each has a plane of symmetry); XII–XV are resolvable (theoretically), since all possess no elements of symmetry. The configurations of these stereoisomers have been determined by methods similar to those used for the truxillic acids; it appears, however, that only four of these six forms are known with certainty, *viz.*,  $\beta$ ,  $\delta$ ,  $\zeta$  and *neo*.

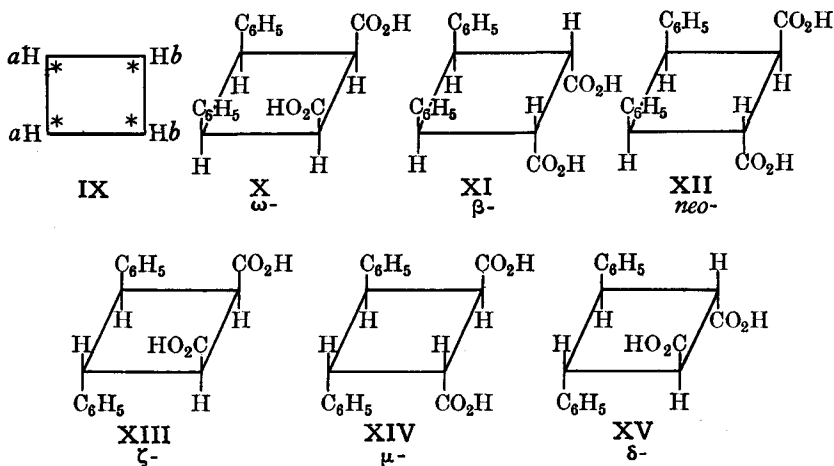

**§10. cycloPentane types.** A number of examples involving the stereochemistry of the five-membered ring occur in natural products, *e.g.*, camphoric acid (§23a. VIII), furanose sugars (§7b. VII). In this section we shall discuss the case of 2 : 5-dimethylcyclopentane-1 : 1-dicarboxylic acid. This acid can exist in two geometrical isomeric forms, which may be differentiated by decarboxylation, the *cis*-isomer giving two monocarboxylic acids, I and II, and the *trans*-isomer one monocarboxylic acid, III (see §5. iii). All three acids contain two similar asymmetric carbon atoms and one pseudo-asymmetric carbon atom. Both I and II possess a (vertical)

plane of symmetry, and are therefore *meso*-forms; III possesses no elements of symmetry, and can therefore exist in two optically active forms (and one racemic modification). All the possible forms are known, and I and II

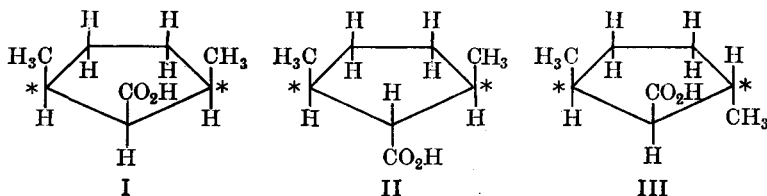

have been differentiated as follows. The diethyl ester of the *cis*-dicarboxylic acid, IV, can be partially hydrolysed to the monoethyl ester, which most probably has the configuration V. This is based on the assumption that the carboxyl group on the same side as the two methyl groups is far more resistant to attack than the other carboxyl group because of the steric effect (see Vol. I). Decarboxylation of V gives VI, and this, on hydrolysis, gives I. Thus the configuration of I (and therefore also of II) is determined.

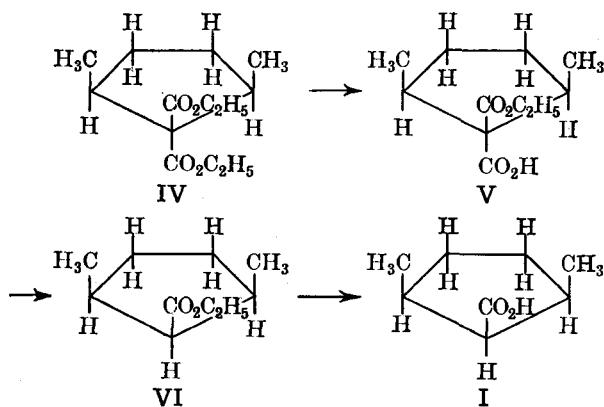

The above treatment of the *cyclopentane* derivatives has been based on the assumption that the ring is planar. This classical treatment leads to agreement between prediction and the number of stereoisomers actually obtained (see *cyclohexane*, §11, for a further discussion of this problem). It is now known that the *cyclopentane* ring is not planar; the puckering, however, is very small. The non-planarity of this ring has been shown from entropy determinations (Aston *et al.*, 1941), spectroscopic studies (Miller *et al.*, 1950) and from a study of the polarisabilities of C—C<sub>aliphatic</sub> and C—H bonds (Le Fèvre *et al.*, 1956).

**§11. *cyclohexane* types.** The stereochemistry of *cyclohexane* and its derivatives presents a detailed example of the principles of conformational analysis (§4a. II). On the basis of the tetrahedral theory, two forms are possible for *cyclohexane*, neither of which is planar. These two forms, known as **boat** and **chair conformations** (Fig. 5), were first proposed by Sachse (1890; see Vol. I, Ch. XIX), who also pointed out that both are strainless. Hassel *et al.* (1943) showed by means of electron diffraction studies that at room temperature most of the molecules existed mainly in the chair conformation. Pitzer (1945) then showed by calculation that the energy difference between the two forms is about 5.6 kg.cal./mole (the

boat form having the higher energy content; see also below). This value, however, is too small for stability, and consequently neither conformation retains its identity, each being readily converted into the other.

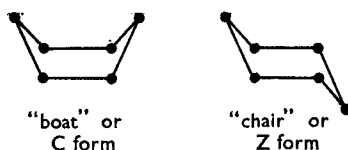

FIG. 4.5.

Although these two forms are free from "angle strain", forces due to steric repulsion (*i.e.*, repulsive forces between non-bonded atoms) are acting, and it is because of their different total effects that the two conformations differ in energy content. A simple method of calculating this energy difference has been introduced by Turner (1952). Fig. 6 (a) and 6 (b) represent the chair and boat conformations and the directions of the C—H bonds. In the chair conformation, all the C—H bonds on adjacent carbons are

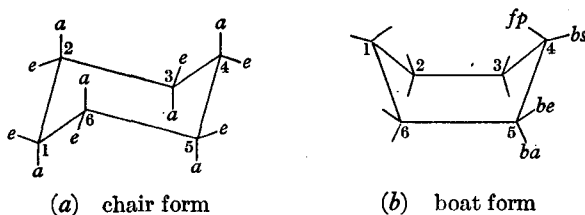

FIG. 4.6.

in the skew position (*i.e.*, the arrangement is skew as in the skew form of *n*-butane, §4. II). On the other hand, in the boat conformation there are four skew interactions (1 : 2, 3 : 4, 4 : 5 and 6 : 1) and two eclipsed interactions (2 : 3 and 5 : 6). According to Pitzer (1940), skew interaction of the hydrogens in *n*-butane is 0.8 kg.cal., and an eclipsed interaction is 3.6 kg.cal. Thus the steric strain in the chair form is  $6 \times 0.8 = 4.8$  kg.cal., and in the boat form  $4 \times 0.8 + 2 \times 3.6 = 10.4$  kg.cal. Thus the boat form has the greater energy content, and the amount (according to the above method of calculation) is 5.6 kg.cal. There is, however, a further interaction in the boat form, *viz.* the interaction of the two flagpole (*fp*) hydrogens (at positions 1 and 4). These are closer together than any other two hydrogens (see table below) and so produce an additional steric repulsion. The actual value of this interaction is not certain, but it is believed to be about the same as that of two eclipsed hydrogens. Thus the energy content of the boat form is  $10.4 + 3.6 = 14$  kg.cal., and hence the boat form contains  $14 - 4.8 = 9.2$  kg.cal. more than the chair form.

Johnson *et al.* (1960), from measurements of heat of combustion and other measured quantities, have found that the energy difference between the boat and chair forms of cyclohexane is  $5.3 \pm 0.3$  kg.cal./mole (at 25°; vapour phase). This value has been confirmed by the work of Allinger *et al.* (1960); their value is  $5.9 \pm 0.6$  kg.cal./mole.

Inspection of Fig. 6 (a) shows that the twelve hydrogen atoms in the chair conformation are not equivalent; there are two sets of six. In one of these sets the six C—H bonds are parallel to the threefold axis of symmetry of the molecule; these are the **axial (a) bonds** (they have also been named *ε*- or *polar* bonds). In the other set the six C—H bonds make an angle of  $109^\circ 28'$  with the axis of the ring (or  $\pm 19^\circ 28'$  with the horizontal plane of the ring); these are the **equatorial (e) bonds** (they have also been named





The nature of the intermediate in the transformation of one chair form into the other is not certain. According to Johnson *et al.* (1961), the boat form of *cyclohexane* is twisted, and Jensen *et al.* (1962) believe that the transition state (of the intermediate) is the structure approximately halfway between the chair and twisted boat forms.

Now let us discuss the conformations of disubstituted *cyclohexanes*. Here we have a number of factors to consider: position isomerism, stereoisomerism (geometrical and optical), the relative sizes of the two substituents, and the nature of the substituents.

### (i) 1 : 2-Compounds

Classical formula

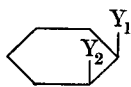

*cis*-1:2

Conformations

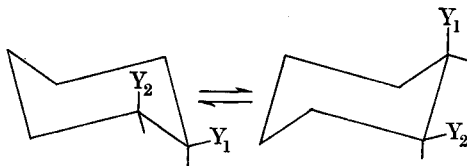

1*e*:2*a*

1*a*:2*e*

It should be noted that in these *cis*-compounds one substituent must be axial and the other equatorial. If the substituents differ in size, the 1 : 3-interactions will be most powerful when the larger group is axial. Thus the conformation with the lower energy will be the one in which the larger group is equatorial, *i.e.*, this is the preferred form. An example of this type is *cis*-2-methylcyclohexanol; the methyl group is larger than the hydroxyl, and so the preferred form can be expected to be 1*a*-hydroxyl : 2*e*-methyl. This has been shown to be so in practice. In general, the greater the difference in size between the two substituents, the greater will be the predominance of the form with the larger group in the equatorial conformation.

The classical formula of the *cis*-compound when the two substituents are identical has a plane of symmetry and is therefore not resolvable. On the other hand, the two conformations are mirror images but not superimposable and hence, in theory, are resolvable. Such compounds, however, have never yet been resolved. The reason for this is that the two forms are separated by such a low energy barrier that they are readily interconvertible.

Classical formula

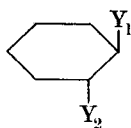

*trans*-1:2

Conformations

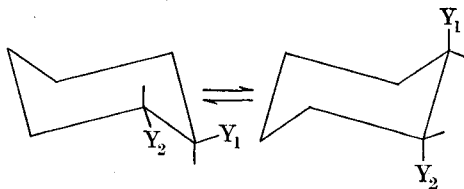

1*e*:2*e*

1*a*:2*a*

Whether  $Y_1$  and  $Y_2$  are identical or not, the two conformations are different, and because of the 1 : 3-interactions the *e* : *e*-form will be the preferred form. Furthermore, this form will be more stable than the *cis*-isomer (*a* : *e*-form). An example that illustrates this is 2-methylcyclohexanol. The *trans*-form has been shown to be more stable than the *cis*; the latter is readily converted into the former when heated with sodium, and also the reduction of 2-methylcyclohexanone (with sodium and ethanol) produces the *trans*-alcohol.

Both the classical formula and the *e* : *e*- (and *a* : *a*) conformation of the

*trans*-1 : 2-compound (whether  $Y_1$  and  $Y_2$  are identical or not) are not superimposable on their mirror images and hence should be optically active. This has been found to be so in practice.

### (ii) 1 : 3-Compounds

Classical formula

Conformations

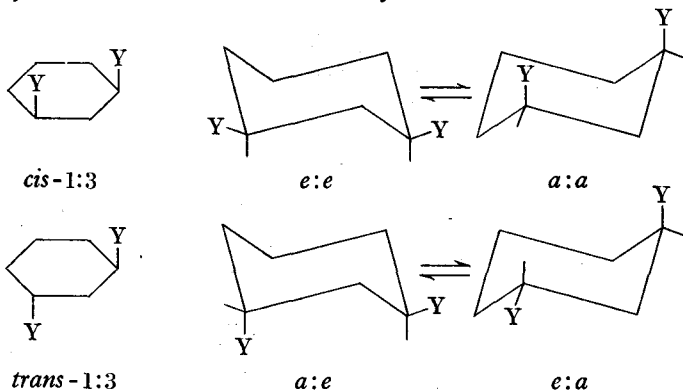

The two *trans*-conformations are identical when the two Y groups are identical. The *cis*- $e:e$ -form will be more stable than the *cis*- $a:a$ , and will also be more stable than the *trans*- $e:a$ -conformation, e.g., the most stable conformation of 1 : 3-dimethylcyclohexane has been shown to be the *cis*-1 : 3- $e:e$ -form. It should be noted that this situation is the reverse of that of the 1 : 2-dimethylcyclohexanes.

The Auwers-Skita rule (§5(x)b) has been shown to break down when applied to 1 : 3-disubstituted cyclohexanes: the reverse holds good. Allinger (1954) modified the rule for cyclohexanes as follows: The isomer which has the higher boiling point, refractive index and density is the one with the less stable configuration. Thus, according to this rule, the *trans*-1 : 3-disubstituted cyclohexanes have the higher physical constants (the *trans*-form has more axial substituents than the more stable *cis*-form); e.g., Macbeth *et al.* (1954) have shown that the physical constants of ( $\pm$ )-*trans*-3-methylcyclohexylamine are higher than those of its *cis*-isomer.

### (iii) 1 : 4-Compounds

Classical formula

Conformations

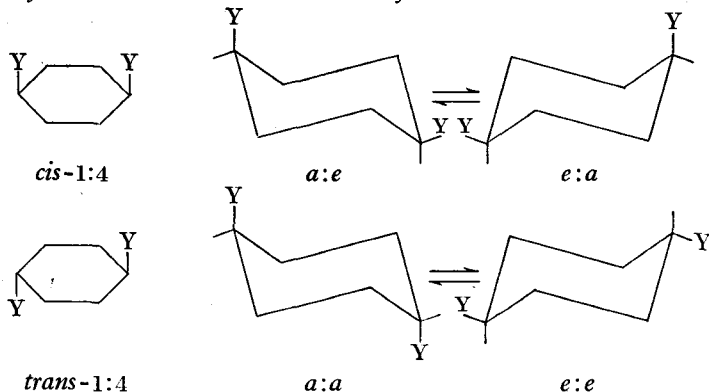

The two *cis*-conformations are identical when the Y groups are identical. Also, the *trans*- $e:e$ -form will be more stable than the *cis*- $a:e$ -form.

The arguments used for the disubstituted *cyclohexanes* can also be applied to the higher substituted *cyclohexanes*. As the result of a large amount of work, the following generalisations may be made:

(i) In *cyclohexane* systems, mono-, di-, tri- and poly-substituted derivatives always tend to take up the chair conformation whenever possible.

(ii) The chair conformation with the maximum number of equatorial substituents will be the preferred conformation. This generalisation, however, is only satisfactory when the internal forces due to dipole interactions or hydrogen bonding are absent. When these are present, it is necessary to determine which forces predominate before a conformation can be assigned to the molecule. As an illustration of this problem, we shall consider 2-bromocyclohexanone; the two possible chair forms are:

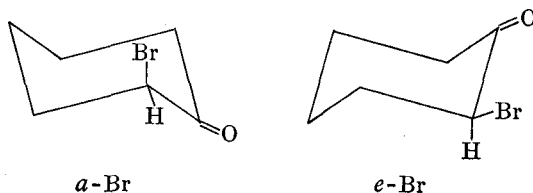

On the basis that a substituent preferably takes up an equatorial conformation, it would therefore be expected that the conformation 2*e*-bromocyclohexanone would be favoured. Infra-red studies, however, have shown that the *a*-bromo conformation predominates. This has been explained as follows. The C—Br and C=O bonds are both strongly polar, and when the bromine is equatorial the dipolar repulsion is a maximum, and a minimum when the bromine is axial. Since the axial form predominates, this equatorial dipolar repulsion must therefore be larger than the 1:3-interactions. When, however, other substituents are present, the 1:3-interactions may become so large as to outweigh the dipolar effect and the bromine would now be equatorial. Such is the case with 2-bromo-4:4-dimethylcyclohexanone (see also §12).

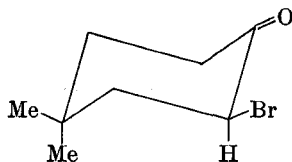

(iii) The energy barriers between the various conformations are too small to prevent interconversion (but see §12). Up to the present time, the number of geometrical (and optical) isomers obtained from a given *cyclohexane* derivative is in agreement with the number that can be expected from a planar ring with the substituents lying above and below the plane of the ring. We shall now, therefore, discuss the stereochemistry of some *cyclohexane* derivatives from the classical point of view.

(i) *Hexahydrophthalic acids* (*cyclohexane*-1:2-dicarboxylic acids). Two geometrical isomers are theoretically possible, the *cis*, I, and the *trans*, II.

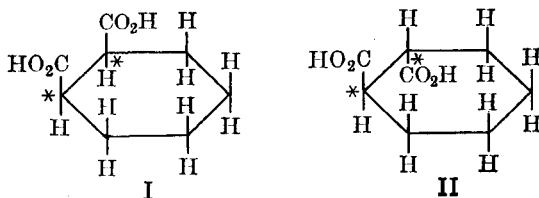

Molecule I has a plane of symmetry, and therefore represents the *meso*-form; II has no elements of symmetry, and can therefore exist in two optically active forms (and one racemic modification). All of these possible forms are known, and it has been found that the *cis*-compound, I, forms a cyclic anhydride readily, whereas the *trans*-compound, II, forms a cyclic anhydride with difficulty (*cf.* §5. i).

(ii) *Hexahydroisophthalic acids* (cyclohexane-1 : 3-dicarboxylic acids). Two geometrical isomers are possible; the *cis*-form, III, has a plane of symmetry, and therefore represents the *meso*-form; IV has no elements of symmetry, and can therefore exist in two optically active forms (and one racemic

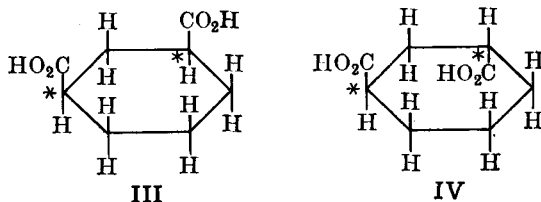

modification). All of these forms are known; the *cis*-isomer forms a cyclic anhydride, whereas the *trans*-isomer does not.

(iii) *Hexahydroterephthalic acids* (cyclohexane-1 : 4-dicarboxylic acids). Two geometrical isomers are possible; the *cis*-form, V, has a plane of symmetry, and the *trans*-form, VI, a centre of symmetry. Hence neither is

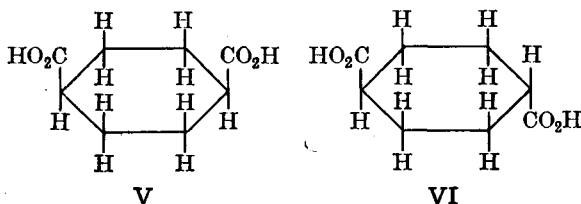

optically active. They may be distinguished by the fact that the *cis*-isomer forms a cyclic anhydride, whereas the *trans*-isomer does not.

(iv) *Inositol* (hexahydroxycyclohexane). There are eight geometrical isomers possible theoretically, and only *one* of these is not superimposable on its mirror image molecule; thus there are nine forms in all (and also one racemic modification). If we imagine that we are looking down at the molecule, and insert the groups which appear *above* the plane of the ring, then the eight geometrical isomers may be represented as follows:

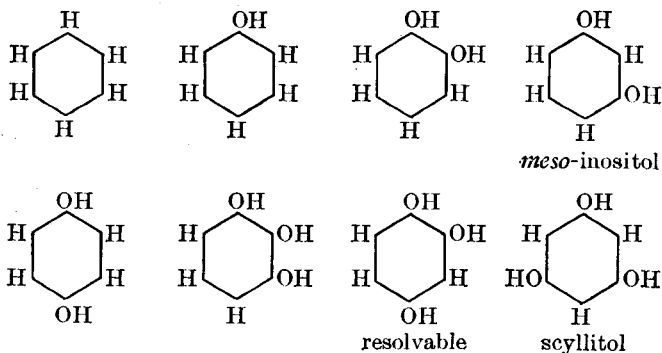

Examination of these configurations shows that all except one—the one labelled *resolvable*—have at least one plane of symmetry, and so are all

*meso*-forms. All the *meso*-forms and both of the optically active forms are known; of these *meso*-inositol, scyllitol and (+)- and (-)-inositol occur naturally.

(v) *Benzene hexachloride* (hexachlorocyclohexane). Here again eight geometrical isomers are possible theoretically; seven are known,  $\alpha$ ,  $\beta$ ,  $\gamma$ ,  $\delta$ ,  $\epsilon$ ,  $\eta$ ,  $\theta$ ; the  $\gamma$ -isomer is a powerful insecticide (see Vol. I). All have been shown to exist in the chair form, and the conformations that have been assigned are:

$\alpha$ -, *aaeeee*;  $\beta$ -, *eeeeee*;  $\gamma$ -, *aaaaee*;  $\delta$ -, *aeeeee*;  $\epsilon$ -, *aeceee*.

Of these forms, it is the  $\beta$ - which loses hydrogen chloride with the greatest difficulty (see §5b). All of the other stereoisomers possess at least one

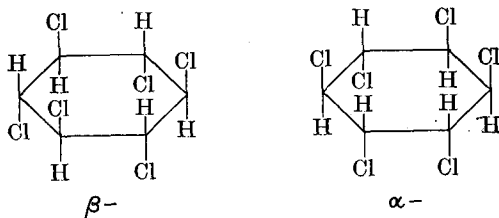

pair of chlorine atoms *cis* to each other (thus having H and Cl *trans*). Cristol (1949) has also identified the  $\alpha$ -isomer as the ( $\pm$ )-form.

(vi) So far, we have discussed the stereochemistry of the *cyclohexane* ring. The same types of stereoisomerism are also exhibited by various sized heterocyclic systems, *e.g.*, dimethyldiketopiperazine (§6. II), furanose (§7b. VII) and pyranose (§7a. VII) sugars.

(vii) *Decalins and decalols*. As we have seen, the boat and chair forms of *cyclohexane* are readily interconvertible, and the result is that *cyclohexane* behaves as if it were planar. Mohr (1918), however, elaborated Sachse's theory, and predicted that the fusion of two *cyclohexane* rings, *e.g.*, as in decalin, should produce the *cis*- and *trans*-forms which would be sufficiently stable to retain their identities. This prediction has now been confirmed experimentally.

A non-committal way of writing the two geometrical isomers of decalin is given by formulæ VII and VIII. On the other hand, several conventions

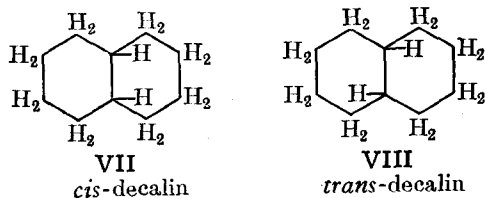

have been introduced to represent these isomers. One convention uses *full* lines to represent groups *above* the plane of the molecule, and *broken* lines to represent those *below* the plane (*cf.* §5. xi); thus *cis*-decalin will be IX

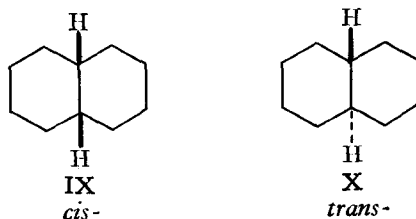

and *trans*-decalin X. This convention appears to be the one most widely used (see, *e.g.*, Steroids, Ch. XI), but there is another, introduced by Linstead (1937), which is favoured by many. According to this convention, a hydrogen atom is represented as being above the plane of the ring when drawn as in XI, and below the plane when drawn as in XII; thus *cis*-decalin will be XIII, and *trans*-decalin XIV.

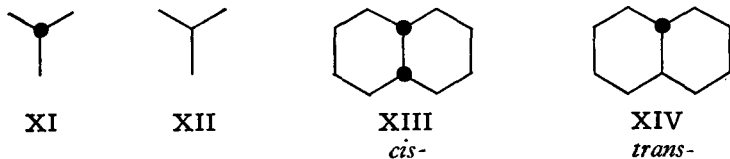

Fig. 7 shows the original diagrammatical method of representing *cis*-decalin by the fusion of two boat forms of *cyclohexane*, and *trans*-decalin by the fusion of two chair forms; these are the forms suggested by Mohr.

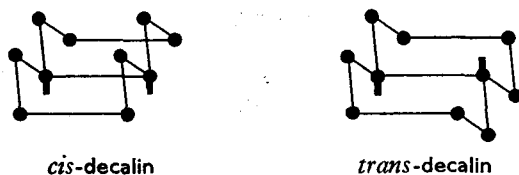

FIG. 4.7.

The configurations of the decalins, however, are now known to be more complicated than this, the complication arising from the fact that a number of strainless modifications are possible, which differ in the type of "locking", *i.e.*, whether axial or equatorial bonds are used to fuse the rings. According to Hassel *et al.* (1946), *cis*- and *trans*-decalins are as shown in Fig. 8; the

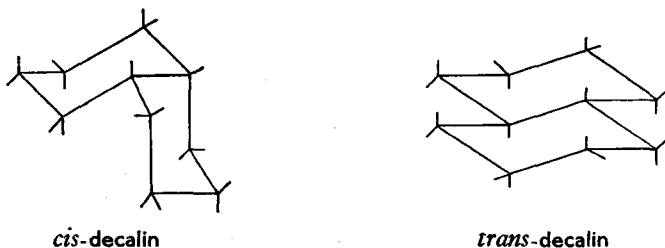
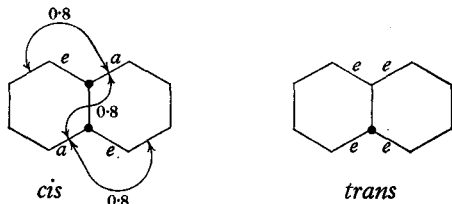

FIG. 4.8.

*cis*-form is produced by joining one axial and one equatorial bond of each ring, whereas the *trans*-form is produced by joining the two rings by equatorial bonds only; in both cases the *cyclohexane* rings are all chair forms (see also below).

Johnson (1953) has calculated the difference in energy content between these two forms in the following simple manner. The *trans*-form is arbitrarily assigned a value of zero energy, and when this form is compared with the *cis*, it will be found that the latter has three extra skew interactions involving the two axial bonds (this is shown in the following diagram; the *cis*-form has 3 staggered and 15 skew arrangements, and the *trans*-form 6 staggered and 12 skew). Since each of these skew interactions is associated with an energy increase of 0.8 kg.cal., the total energy difference between the *cis*- and *trans*-forms is  $3 \times 0.8 = 2.4$  kg.cal. This value agrees well with that of Rossini *et al.* (1960) from measurements of heat of combustion.

It might be noted, in passing, that if these two decalins are regarded as 1 : 2-disubstituted *cyclohexanes*, then the *trans*-form (*e* : *e*) would be expected to be more stable than the *cis*- (*e* : *a*).



We shall now deal with the determination of configuration in the decalin series. The configurations may be ascertained by using the Auwers-Skita rule (see §5. (x)*b*). Hückel (1923, 1925), however, isolated two forms of 2-decalol and determined their configurations by the following chemical methods. 2-Naphthol, on hydrogenation in the presence of nickel as catalyst, gave two 2-decalols, XV and XVI, each of which, on oxidation with chromic acid, gave a decal-2-one (XVII and XVIII). These two decalones each gave, on oxidation with permanganate, a *cyclohexane*-1 : 2-diacetic acid. These diacetic acids were geometrical isomers; one was resolvable and therefore must be the *trans*-isomer, XX; and the other, which was not resolvable, must therefore be the *cis*-isomer, XIX (this is the *meso*-form). Thus the configurations of the two decalols and the two decalones are established:

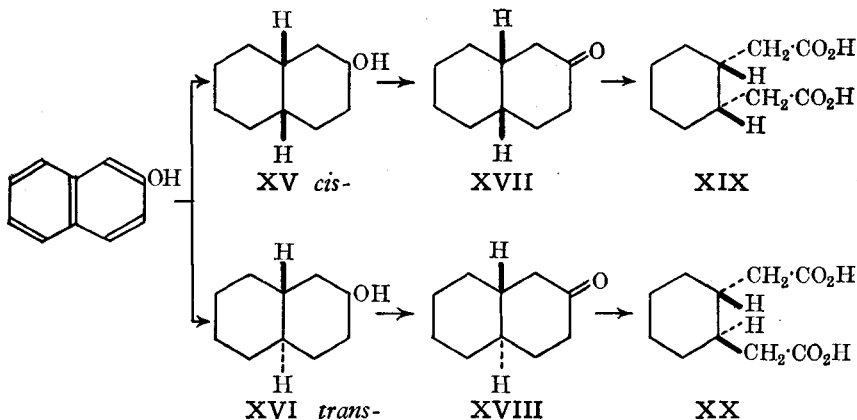

In addition to the two *cyclohexane*-1 : 2-diacetic acids (which are formed by scission of the 2 : 3-bond of the decalone), two other geometrical isomers were also obtained, *viz.* *cis*- and *trans*-*cyclohexane*-1-carboxyl-2-propionic acids, XXI and XXII (these are formed by scission of the 1 : 2-bond of the decalone).

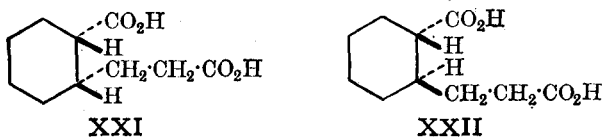

The conversion of 2-naphthol into two decalols does not prove that the two decalols are the *cis*- and *trans*-isomers described above. It is possible that both compounds could have been the *cis*- and *trans*-forms of a *given* decalol; since the carbon atom of the *CHOH* group in the 2-decalol is asym-



metric, it can exist in *two* configurations, *i.e.*, each decalol, XV and XVI, can exist in two forms; XV*a* and XVI*a*. Had the two decalols been the

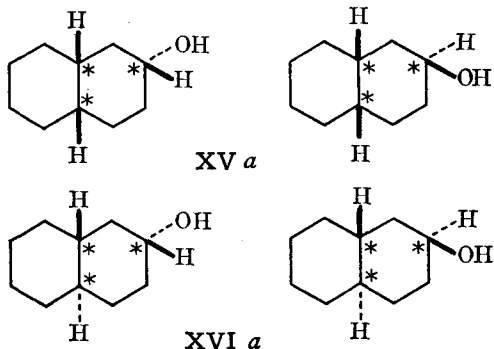

two forms of either XV or XVI, then on their oxidation, only *one* decalone would have been produced. Since, however, *two* decalones were obtained, the two decalols must be of the types XV and XVI—one of each, or even a mixture of the pairs; further proof of the existence of the types XV and XVI lies in the fact that the two decalones gave geometrical isomers of cyclohexane-1 : 2-diacetic acid.

Consideration of formulæ XV*a* and XVI*a* shows the presence of three asymmetric carbon atoms in each of the four possible forms, and since all four possess no elements of symmetry, four pairs of enantiomorphs should be possible theoretically. Actually all eight forms have been isolated, but their configurations have not yet been established with certainty.

There are only *two* geometrical isomers possible for the decalins, and their configurations have been established by the reduction of the two decalones, XVII and XVIII, by means of the Wolff-Kishner method (Eisenlohr *et al.*, 1924; see also Vol. I); each decalone gives the corresponding decalin. It is interesting to note in this connection that Willstätter *et al.* (1924) found that hydrogenation of naphthalene in the presence of platinum black as catalyst gives mainly *cis*-decalin, whereas in the presence of nickel as catalyst the main product is *trans*-decalin. The configurations of the decalins have also been determined by means of their NMR spectra (see also end of this section).

Various other fused ring systems have also been shown to exhibit the

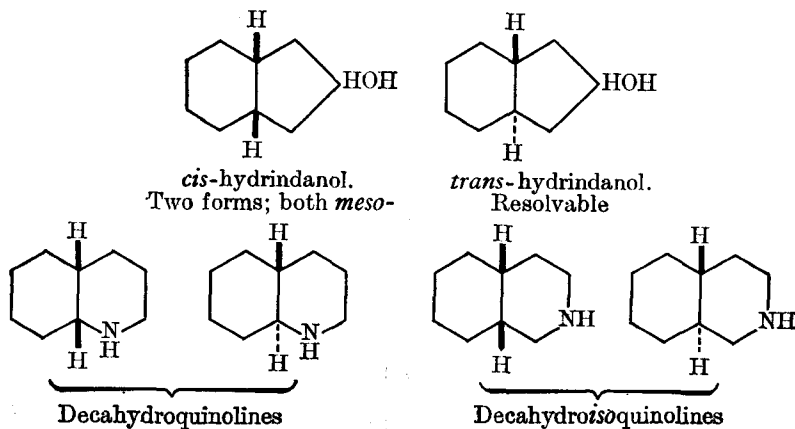

same type of geometrical isomerism as the decalins, *e.g.*, the hydrindanols exist in *cis*- and *trans*-forms (Hückel *et al.*, 1926), and also the decahydroquinolines and decahydroisoquinolines (Helfer *et al.*, 1923, 1926).

It has already been pointed out that in monosubstituted cyclohexanes, the preferred conformation is the one with the substituent equatorial, but owing to the low energy barrier between this and the axial form, the two are readily interconvertible. In the case of the monosubstituted decalins, the problem is more complicated. In *cis*-decalin, since ring fusion involves equatorial and axial bonds, the molecule is flexible and can interchange with the other *cis*-form, *i.e.*, there are two *cis*-forms possible (XXIII and XXIV), and these are identical and in equilibrium (*cf.* cyclohexane). This has been shown to be so by Hassel (1950); thus:

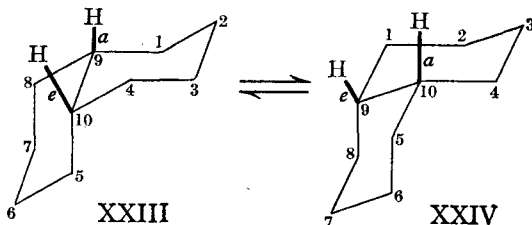

As pointed out above, Musher *et al.* (1958) distinguished between *cis*- and *trans*-decalin by means of their NMR spectra. The former gives a sharp band whereas the latter gives a broad spectrum. These differences are due to the former molecule undergoing relatively rapid interconversion between the two conformations, whilst the latter molecule has a more rigid structure and hence the axial and equatorial hydrogen atoms are distinguishable (and so give a broad spectrum).

Now let us consider *cis*-2-decalol. Here there are four possible conformations which, in pairs, are in equilibrium. Two arise from XXIII (XXIII*a* and XXIII*b*), and two from XXIV (XXIV*a* and XXIV*b*).

In XXIII*a* and XXIV*b* the hydroxyl group is equatorial, and so these two conformations contain about the same energy. In XXIV*a* and XXIII*b* the hydroxyl group is axial, and on the basis that an equatorial conformation is more stable than an axial, then XXIII*a* and XXIV*b* will contribute

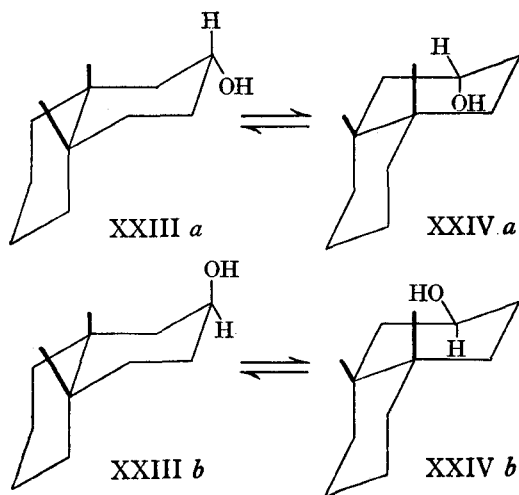

more to the actual state of the molecule than will XXIVa and XXIIIb, *i.e.*, the hydroxyl group in *cis*-2-decalol should possess more equatorial character than axial. It is also interesting to note that the two axial forms do not contain the same energy. In XXIIIb the *a*-hydroxyl group is involved in the normal 1 : 3-hydrogen interactions (at 4 and 9), but in XXIVa the interaction is the normal 1 : 3- with the hydrogen at 4 and the larger 1 : 3-interaction with the CH<sub>2</sub> group at 8. Thus XXIVa should be less stable than XXIIIb.

In *trans*-decalin there is only one stable conformation, since the ring fusions use equatorial bonds. If the molecular conformation were "inverted", the two ring fusions would now have to be axial, and this type of fusion is impossible (the axial bonds on adjacent carbon atoms are pointing in *opposite* directions). Thus, in *trans*-2-decalol, there are only two conformations possible, XXV and XXVI. Furthermore, the latter, with

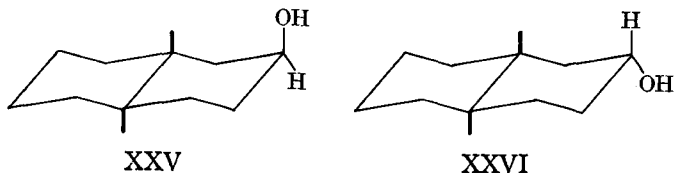

the equatorial-hydroxyl conformation, would be expected to be more stable than the former (with the axial hydroxyl).

### §12. Effect of conformation on the course and rate of reactions.

Since the environments of axial and equatorial groups are different, it may be expected that the reactivity of a given group will depend on whether it is axial or equatorial. Now S<sub>N</sub>2 reactions always occur with inversion (§4. III). Hence if the geometry of the molecule is such as to hinder the approach of the attacking group (Z) along the bonding line remote from the group to be expelled (Y), then the S<sub>N</sub>2 reaction will be slowed down. Examination of formulæ I and II shows that the transition state for an S<sub>N</sub>2 reaction is more readily formed when Y is axial (I) than when it is equatorial (II). In I, the approach of Z is unhindered and the expulsion

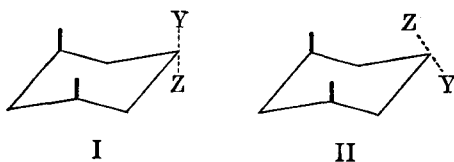

of Y assisted by the normal 1 : 3-interactions. In II, the approach of Z is hindered by the rest of the ring. Thus S<sub>N</sub>2 reactions take place more readily with an axial substituent than with an equatorial.

The study of S<sub>N</sub>1 reactions in *cyclohexane* derivatives is made difficult because of the ease with which elimination reactions usually occur at the same time. It can be expected, however, that an S<sub>N</sub>1 reaction will be sterically accelerated for an axial substituent, since the formation of a carbonium ion will relieve the steric strain due to 1 : 3-interactions. On the other hand, since these 1 : 3-interactions are absent for an equatorial substituent, no steric acceleration will operate in this conformation.

A particularly important substituent group in cyclic compounds is hydroxyl, and two very important reactions in which this group is involved are esterification and hydrolysis (of the ester). Owing to the hindered character of an axial group due to 1 : 3-interactions, esterification and hydrolysis will occur more readily with the equatorial conformation. In

the same way, esterification and hydrolysis of esters in which a carboxyl group is the substituent will also occur more readily when this group is equatorial. On the other hand, the relative rates of oxidation of secondary *a*- and *e*-alcohols to ketones by chromic acid (or hypobromous acid) is the reverse of the relative rates of hydrolysis of their carboxylic esters, *i.e.*, an *a*-hydroxyl is more readily oxidised than an *e*-. The reason for this is that the rate-determining step in this oxidation is a direct attack on the hydrogen atom of the C—H bond. If the hydroxyl is axial, the hydrogen is equatorial, and *vice versa*; thus:

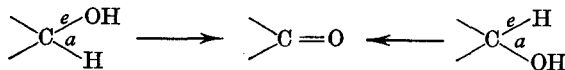

Elimination reactions are also of great importance in cyclic compounds. As we have seen (§5b), in ionic E2 reactions the four centres involved lie in a plane. In *cyclohexane* systems this geometrical requirement is only found in *trans*-1 : 2-diaxial compounds, and these compounds thus undergo ready elimination reactions. In rigid systems, *e.g.*, the *trans*-decalin type, elimination in *trans*-1 : 2-diequatorial compounds is slower than in the corresponding diaxial compounds. *cis*-1 : 2-Compounds (in which one substituent must be axial and the other equatorial) undergo elimination reactions slowly.

The steric course of E1 reactions is more difficult to study than that of E2 reactions because of the two-stage mechanism. This makes it difficult to ascertain the geometry of the intermediates involved. The formation of the carbonium ion will be sterically accelerated if the ionising group is axial and, if a second group is eliminated to form a double bond, this second stage will also be sterically accelerated if the second group is axial. Barton *et al.* (1951) have pointed out various examples in which E1 reactions are favoured by the diaxial conformation.

The arguments used above are satisfactory so long as we know whether the group under discussion is axial or equatorial. Since, however, the two chair forms are readily interconvertible and in equilibrium, to study these predictions experimentally it is necessary to deal with "rigid" conformations. The *t*-butyl group, because of its large size, is far more stable in the *e*- than in the *a*-position (the energy difference between the two forms is about 5.6 kcal./mole; Winstein *et al.*, 1955). Thus almost only the *e*-form is present and consequently this position is "locked". Therefore 4-substituents must be axial when *cis* to the *t*-butyl group and equatorial when *trans* to this group (§11). Working with different substituents in the 4-position with respect to the *t*-butyl group, various workers have confirmed the above predictions experimentally, *e.g.*, it has been shown that *cis*-4-*t*-butylcyclohexanol forms esters more slowly than the *trans*-isomer, and similarly *cis*-4-*t*-butylcyclohexane-1-carboxylic acid is more slowly esterified and the ester more slowly hydrolysed than the *trans*-isomer.

Another interesting example is the case of 4-*t*-butylcyclohexyl tosylate (ElieI *et al.*, 1956). Two forms are possible, *cis* and *trans*, but because of the large bulk of the *t*-butyl group, this group is always equatorial. Under

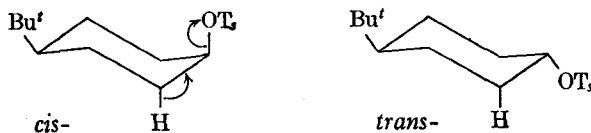

the same conditions (sodium ethoxide in ethanol at 70°), the *cis*-form readily undergoes bimolecular elimination (E2), but the *trans*- does not. The latter, however, does undergo unimolecular (E1) elimination.

Some examples of neighbouring group participation in *cyclohexane* systems have been described in Ch. III (§§6b, 6c, 6d). These examples clearly show the effect of conformation on rates of reaction when anchimeric assistance is possible.

Not only does conformation control the rate of reactions, but it also may affect the course of a reaction. An example of the latter effect is the elimination reaction undergone by 2-phenyl*cyclohexanol* in the presence of phosphoric acid to form phenyl*cyclohexene*. Price *et al.* (1940) have shown that both the *cis* and *trans* alcohols are dehydrated, the former more readily than the latter. The product was shown to be a mixture of phenyl*cyclohex-1- and 2-ene*, the former predominating when the *cis*-alcohol was used, and both olefins being present in about equal amounts when the *trans*-alcohol was used. The reaction has been shown to proceed by the E1 mechanism, but the reason for the different proportions of olefins is uncertain.

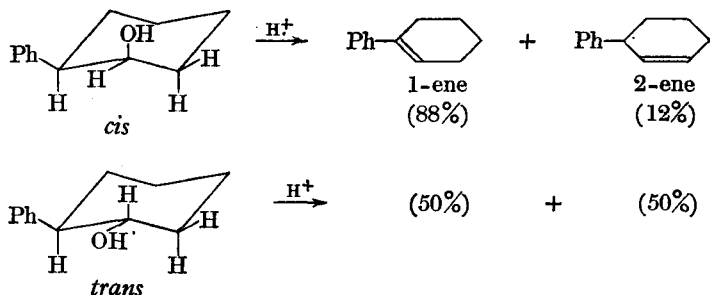

Another example of the effect of conformation on the course of a reaction in *cyclohexane* systems is the action of nitrous acid on amines. Mills (1953) has proposed the following generalisation: When the amino-group is equatorial, the product is an alcohol with an equatorial conformation; but when the amino-group is axial, the main product is an olefin together with some equatorial alcohol.

Just as *trans* elimination is favoured with the two groups axial and *trans*, so it has been found that addition of electrophilic reagents to a double bond in *cyclohexenes* is predominantly diaxial.

As we have seen, although there is a preferred form in *cyclohexane* derivatives, the energy of interconversion between the preferred and less stable form is too low to permit their being distinguished by the classical methods of stereochemistry. This predominance of the preferred form holds good at room temperature (or below). At higher temperatures, or during the course of a chemical reaction, the preponderance of the preferred form may be reduced. In chemical reactions, it may be possible for the reaction to proceed more readily through the less stable conformation because it is this one which more closely approaches the geometry of the transition state. An example of this type is chloro*cyclohexane*. As we have seen, the preferred form is the equatorial conformation. This compound, on treatment with ethanolic potassium hydroxide, undergoes dehydrohalogenation to form *cyclohexene*. Since *trans* elimination is preferred, the reaction probably proceeds *via* the axial form.

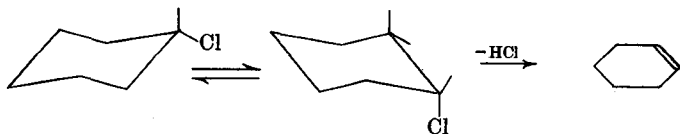

Allinger *et al.* (1961) have examined the conformations of the 2-halocyclohexanones by polarographic methods. It was suggested that since these compounds are polarographically reduced (Elving *et al.*, 1956), it seems likely that the reduction potential of such a system will depend on the conformation of the halogen atom. This prediction was shown to be the case in practice. The authors showed that for systems with relatively fixed conformation, such as the 2-halo-4-*t*-butylcyclohexanones, the epimer with the axial halogen is reduced more easily. Furthermore, it was found that a flexible molecule such as 2-chlorocyclohexanone, which contains *comparable* amounts of the two conformations, showed the potential characteristic of the more easily reduced (axial) form. This is understandable on the basis that the *e*-form is very readily converted into the *a*-form, the rate of the conversion being rapid compared with the rate of the reduction.

Now let us consider reactions involving the hydroxyl group. It has already been pointed out that equatorial hydroxyl groups are more readily esterified, and equatorial esters more readily hydrolysed, than when these groups are axial. If an axial ester group has to stay in this position during hydrolysis, then because of the steric hindrance (1 : 3-interactions), the rate will be relatively slow (reaction path A). It is possible, however, that prior to reaction, the molecule is forced into the equatorial conformation (*cf.* chlorocyclohexane above). If this were to happen, then the slower rate of hydrolysis would be due to the additional energy required to bring about the change in conformation (reaction path B).

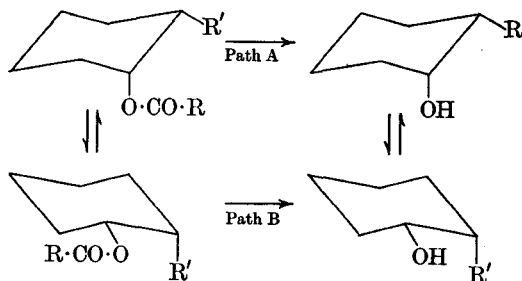

Experimental data has enabled one path to be distinguished from the other (see also §16. VIII).

In *fused systems*, owing to the rigidity of the structure, such interconversions (as described above) are far less likely to occur.

In this chapter, the discussion of conformational analysis has been applied to cyclohexane and its derivatives, and this has been done in order to introduce some of the ideas connected with this problem. The generalisations applicable to cyclohexane compounds, however, are also applicable to heterocyclic compounds containing nitrogen, oxygen or sulphur (see, *e.g.*, tropines, §22. XIV; carbohydrates, §7h. VII). They are also applicable to the polynuclear compounds, *e.g.*, the Steroids; in fact, much of the work leading to these generalisations has been carried out on these compounds (see §4c. XI).

#### READING REFERENCES

- Wheland, *Advanced Organic Chemistry*, Wiley (1960, 3rd ed.). Ch. 7. The Stereochemistry of Additions to Carbon-Carbon Double Bonds.
- Ingold, *Structure and Mechanism in Organic Chemistry*, Bell and Sons (1953). Ch. 12. Additions and Their Retrogressions.
- Gilman (Ed.), *Advanced Organic Chemistry*, Wiley. Vol. IV (1953). Ch. 12. Oxidation Processes.
- Crombie, Geometrical Isomerism about Carbon-Carbon Double Bonds, *Quart. Reviews (Chem. Soc.)*, 1952, 6, 101.

- Reid, The Triplet State, *Quart. Reviews (Chem. Soc.)*, 1958, **12**, 205 (see especially pp. 216-219).
- Porter, The Triplet State in Chemistry, *Proc. Chem. Soc.*, 1959, 291.
- DePuy and King, Pyrolytic Cis Eliminations, *Chem. Reviews*, 1960, **60**, 431.
- Hassel, Stereochemistry of cycloHexane, *Quart. Reviews (Chem. Soc.)*, 1953, **7**, 221.
- Bent, Aspects of Isomerism and Mesomerism, *J. Chem. Educ.*, 1953, **30**, 220, 284, 328.
- Figueras, Stereochemistry of Simple Ring Systems, *J. Chem. Educ.*, 1951, **28**, 134.
- Klyne (Ed.), *Progress in Stereochemistry*, Butterworth (1954). Ch. 2. The Conformation of Six-membered Ring Systems.
- Barton and Cookson, The Principles of Conformational Analysis, *Quart. Reviews (Chem. Soc.)*, 1956, **10**, 44.
- Orloff, The Stereoisomerism of cycloHexane Derivatives, *Chem. Reviews*, 1954, **54**, 347.
- Newman (Ed.), *Steric Effects in Organic Chemistry*, Wiley (1956). Ch. I. Conformational Analysis.
- Angyal, The Inositols, *Quart. Reviews (Chem. Soc.)*, 1957, **11**, 212.
- Brewster, The Optical Activity of Saturated Cyclic Compounds, *J. Amer. Chem. Soc.*, 1959, **81**, 5483.
- Eliel, Conformational Analysis in Mobile Systems, *J. Chem. Educ.*, 1960, **37**, 126.

## STEREOCHEMISTRY OF DIPHENYL COMPOUNDS

§1. **Configuration of the diphenyl molecule.** If we assume that the benzene ring is planar, then the diphenyl molecule will consist of two planar rings; but without any further information we cannot say how these two rings are arranged spatially. Kaufler (1907) proposed the "butterfly" formula, I, in order to account for the chemical behaviour of various diphenyl derivatives, *e.g.*, Michler and Zimmermann (1881) had condensed

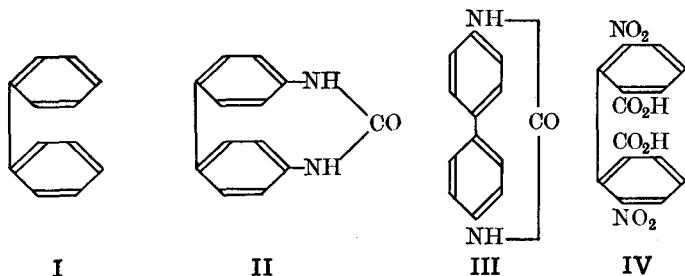

benzidine with carbonyl chloride and obtained a product to which Kaufler assigned structure II. According to Kaufler, the co-axial structure III was impossible, since the two amino-groups are too far apart to react simultaneously with carbonyl chloride; it should be noted that this *simultaneous* reaction at both ends was assumed by Kaufler. Simultaneous reaction, however, is reasonable (according to Kaufler) on the folded structure, II.

Now Schultz (1880) had prepared a dinitrodiphenic acid by the nitration of diphenic acid, and Schmidt *et al.* (1903), from their work on this acid, believed it to be 6 : 6'-dinitrodiphenic acid, IV; these workers, it should be noted, did not synthesise the acid. In 1921, however, Kenner *et al.* synthesised 6 : 6'-dinitrodiphenic acid by means of the Ullmann reaction (see Vol. I) on the ethyl ester of 2-chloro-3-nitrobenzoic acid, and hydrolysing the product. This acid, V (written with the two benzene rings co-axial), did not have the same melting point as Schultz's acid, and so Kenner, believing that his and Schultz's acid were both 6 : 6'-dinitrodiphenic acid, suggested that the two were stereoisomers. Then Christie and Kenner

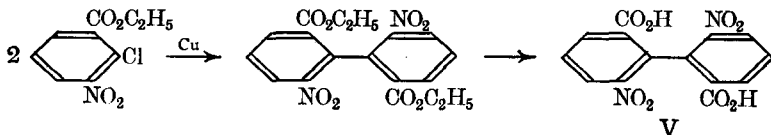

(1922) showed that Kenner's acid was resolvable, and pointed out that this could be explained on the Kaufler formula, IV, since this structure has no elements of symmetry. These authors, however, also pointed out that the optical activity could also be accounted for by the co-axial structure, V, provided that the two benzene rings do not lie on one plane (see also §2).

Kaufler's formula, as we have seen, was based on the assumption that the two amino-groups in benzidine react *simultaneously* with various reagents. Re-investigation of these reactions showed that this was not the case, *e.g.*, Turner and Le Fèvre (1926) found that the compound produced from



benzidine and carbonyl chloride was not as originally formulated (see II or III), but had a free amino-group, *i.e.*, the compound was

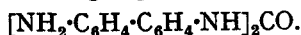

Hence Kaufler's *reason* for his butterfly formula is incorrect, and although it does not necessarily follow that the *formula* is incorrect, nevertheless Turner's work weakened Kaufler's claim. One of the strongest bits of chemical evidence for rejecting Kaufler's formula is that of Barber and Smiles (1928). These workers prepared the three dimercaptodiphenyls, VI, VII and VIII, and oxidised each one. Only one of them, the 2:2'-

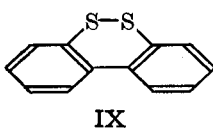
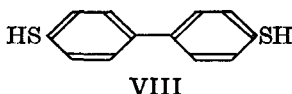
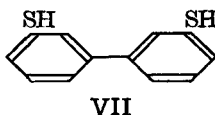
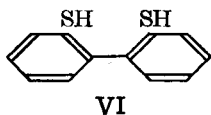

derivative, VI, gave the intramolecular disulphide (diphenylene disulphide, IX). On the Kaufler formula, all three dithiols would be expected to give the intramolecular disulphides, since the two thiol groups are equally distant in all three compounds.

Physico-chemical methods have also been used to determine the configuration of the diphenyl molecule, *e.g.*, the crystal structure of 4:4'-diphenyl derivatives shows a centre of symmetry; this is only possible for the co-axial formula. Dipole moment measurements also confirm this configuration, *e.g.*, the dipole moment of 4:4'-dichlorodiphenyl is zero; this again is only possible if the two benzene rings are co-axial.

**§2. Optical activity of diphenyl compounds.** Christie and Kenner's work (see above) has been extended by other workers, who showed that compounds in which at least *three* of the four *ortho*-positions in diphenyl are occupied by certain groups could be resolved. It was then soon found that two conditions were necessary for diphenyl compounds to exhibit optical activity:

(i) Neither ring must have a vertical plane of symmetry. Thus I is not resolvable, but II is.

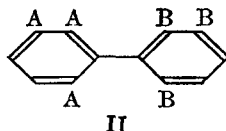
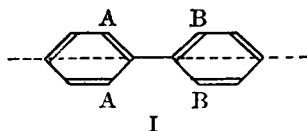

(ii) The substituents in the *ortho*-positions must have a large size, *e.g.*, the following compounds were resolved: 6-nitrodiphenic acid, 6:6'-dinitrodiphenic acid, 6:6'-dichlorodiphenic acid, 2:2'-diamino-6:6'-dimethyldiphenyl (see also §4).

The earlier work showed that three groups had to be present in the *ortho*-positions. This gave rise to the theory that the groups in these positions impinged on one another when free rotation was attempted, *i.e.*, the steric effect prevented free rotation. This theory of restricted rotation about the single bond joining the two benzene rings (in the co-axial formula) was suggested simultaneously in 1926 by Turner and Le Fèvre, Bell and Kenyon,

and Mills. Consider molecule III and its mirror image IV. Provided that the groups A, B and C are large enough to "interfere mechanically", *i.e.*, to behave as "obstacles", then free rotation about the single bond is

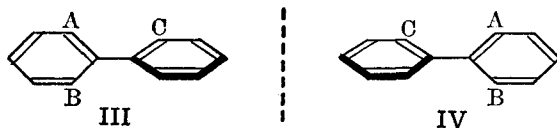

restricted. Thus the two benzene rings cannot be coplanar and consequently IV is not superimposable on III, *i.e.*, III and IV are enantiomorphs. In molecule III there is no asymmetric carbon atom; it is the molecule *as a whole* which is asymmetric, due to the restricted rotation.

In diphenyl the two benzene rings are co-axial, and in optically active diphenyl derivatives the rings are inclined to each other due to the steric and repulsive effects of the groups in the *ortho*-positions. The actual angle of inclination of the two rings depends on the nature of the substituent groups, but it appears to be usually in the vicinity of  $90^\circ$ , *i.e.*, the rings tend to be approximately perpendicular to each other. Thus, in order to exhibit optical activity, the substituent groups in the *ortho*-positions must

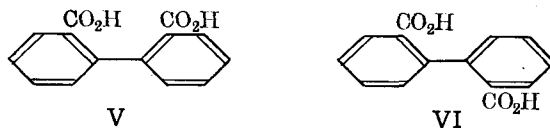

be large enough to prevent the two rings from becoming coplanar, in which case the molecule would possess a plane or a centre of symmetry, *e.g.*, diphenic acid is not optically active. In configuration V the molecule has a plane of symmetry, and in configuration VI a centre of symmetry; of these two, VI is the more likely because of the repulsion between the two carboxyl groups (*cf.* §4. II).

If restricted rotation in diphenyl compounds is due entirely to the spatial effect, then theoretically we have only to calculate the size of the group in order to ascertain whether the groups will impinge and thereby give rise to optical activity. In practice, however, it is found that groups (and atoms) behave as if they were larger than the volumes obtained from group (and atomic) radii (*cf.* §15b. I). This behaviour is largely due to the fact that groups also repel (or attract) one another because of the electric charges that are usually present on these groups. Thus the actual distance that the atoms or groups (in the *ortho*-positions) can approach one another is *greater* than that obtained from the atomic and group radii. Better agreement with experiment is obtained when the van der Waals radii (§2. I) are used for calculating the "size" of a group.

Later work has shown that if the substituent groups are large enough, then only *two* in the *o*- and *o'*-positions will produce restricted rotation, *e.g.*, Lesslie and Turner (1932) resolved diphenyl-2 : 2'-disulphonic acid, VII. In this molecule the sulphonic acid group is large enough to be impeded by the *ortho*-hydrogen atoms. Lesslie and Turner (1933) have also resolved

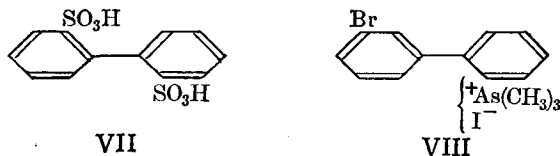

the arsonium compound VIII; here also the trimethylarsonium group is large enough to be impeded by the *ortho*-hydrogen atoms (the bromine atom in the *meta*-position gives asymmetry to this ring). This example is unique up to the present in that only *one* substituent in the *ortho*-position produces optical activity in diphenyl compounds.

It has already been pointed out that diphenic acid is not optically active, and that its configuration is most probably VI. Now calculation shows that the effective diameter of the carboxyl group is large enough to prevent configuration V from being planar, and consequently, if the two rings could be held more or less in this configuration, the molecule would not be coplanar and hence would be resolvable. Such a compound, IX, was prepared and resolved by Adams and Kornblum (1941). The two benzene

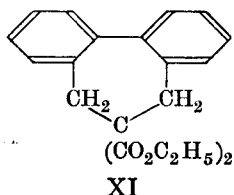
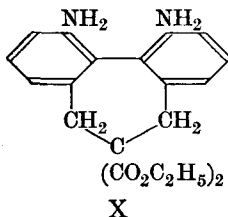
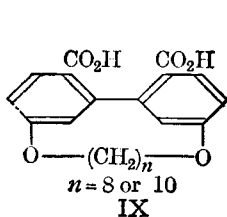

rings are not coplanar and are held fairly rigid by the large methylene ring. Iffland *et al.* (1956) have also prepared the optically active diphenyl X which has a 2 : 2'-bridge and two amino-groups in the 6 : 6'-positions. On the other hand, these authors have also prepared XI in optically active forms; this compound has the 2 : 2'-bridge but no substituents in the 6 : 6'-positions. Mislow (1957) has also obtained the dibenzocyclo-octadiene acids, XII, in optically active forms; both forms were highly optically labile. Similar to

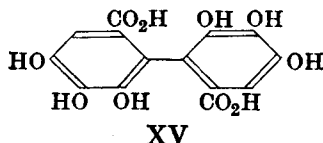
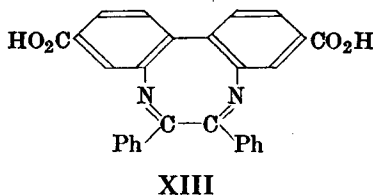
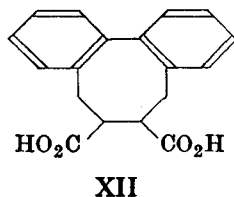

XII is XIII which has been resolved by Bell (1952). Mislow *et al.* (1961) have also resolved the diphenyl derivative XIV.

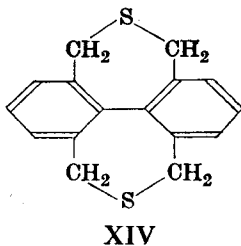

A point of interest in connection with optically active diphenyls is that Schmidt *et al.* (1957) have shown that XV occurs naturally in an optically active form.

**§2a. Absolute configurations of diphenyls.** Mislow *et al.* (1958) have determined the absolute configuration of 6 : 6'-dinitro-2 : 2'-diphenic acid. Their method was chemical; assignment of absolute configuration has been obtained from a consideration of the transition states in the Meerwein-Ponndorf-Verley reduction of a dissymmetric diphenylic ketone by asymmetric alcohols of known absolute configuration (*cf.* §7. III). Using this diphenyl as absolute standard, Mislow *et al.* (1958) then correlated configurations in the diphenyl series by the quasi-racemate method (§9a. II). In this way these authors determined the configurations of 6 : 6'-dichloro- and 6 : 6'-dimethyl-2 : 2'-diphenic acid. Mislow *et al.* (1960) have also confirmed absolute configurations in the diphenyl series by the rotatory dispersion method (§12a. I).

**§3. Other examples of restricted rotation.** In addition to the diphenyl compounds, there are many other examples where optical activity in the molecule is produced by restricted rotation about a single bond which may or may not be one that joins two rings. The following examples are only a few out of a very large number of compounds that have been resolved.

(i) Adams *et al.* (1931) have resolved the following *N*-phenylpyrrole and *N* : *N'*-dipyrrol.

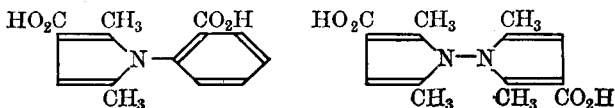

Adams *et al.* (1932) have also resolved the 3 : 3'-dipyridyl

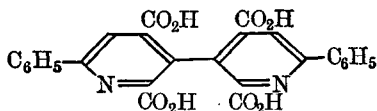

(ii) 1 : 1'-Dinaphthyl-8 : 8'-dicarboxylic acid has been obtained in optically active forms by Stanley (1931).

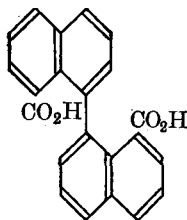

This compound gives rise to asymmetric transformation (§10 iv. II); resolution with brucine gave 100 per cent. of either the (+)- or (-)-compound.

Other compounds similar to the dinaphthyl which have been obtained in optically active forms are 1 : 1'-dinaphthyl-5 : 5'-dicarboxylic acid, I (Bell *et al.*, 1951), the dianthryl derivatives, II and III (Bell *et al.*, 1949), and the 4 : 4'- and 5 : 5'-diquinolyls, IV and V (Crawford *et al.*, 1952).

(iii) Mills and Elliott (1928) obtained *N*-benzenesulphonyl-8-nitro-1-naphthylglycine, VI, in optically active forms; these were optically unstable,



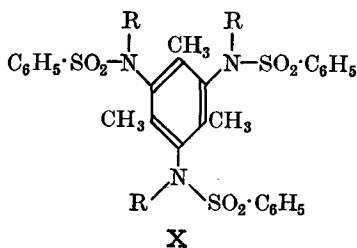

(iv) Lüttringhaus *et al.* (1940, 1947) isolated two optically active forms of 4-bromogentisic acid decamethylene ether. In this compound the methylene ring is perpendicular to the plane of the benzene ring; the two substituents, Br and CO<sub>2</sub>H, prevent the rotation of the benzene nucleus inside



the large ring. Cram *et al.* (1955) have obtained a paracyclophane in optically active forms; there is insufficient space to allow the benzene ring carrying the carboxyl group to rotate to give the enantiomorph. In this compound the two benzene rings are parallel and perpendicular to the plane

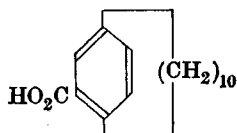

of the ring. On the other hand, Blomquist *et al.* (1961) have resolved the simple paracyclophane shown.

(v) Terphenyl compounds can exhibit both geometrical and optical isomerism when suitable substituents are present to prevent free rotation about single bonds, *e.g.*, Shildneck and Adams (1931) obtained the following compound in both the *cis*- and *trans*-forms.

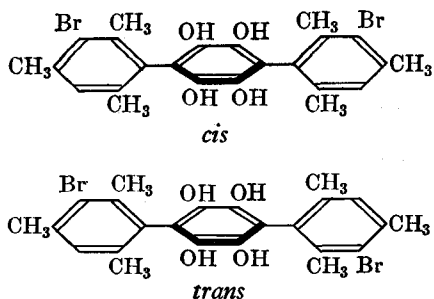

Interference of the methyl and hydroxyl groups in the *ortho*-positions prevents free rotation and tends to hold the two outside rings perpendicular to the centre ring. Inspection of these formulæ shows that if the centre ring does not possess a vertical plane of symmetry, then optical activity is



lie in this plane. If, however, there are fairly large groups in positions 4 and 5, then there will not be enough room to accommodate both groups in the plane of the nucleus. This leads to strain being produced by intramolecular overcrowding, and the strain may be relieved by the bending of the substituents out of the plane of the nucleus, or by the bending (buckling) of the aromatic rings, or by both. Thus the molecule will not be planar and consequently will be asymmetric and therefore (theoretically) resolvable. Newman *et al.* (1940, 1947) have actually partially resolved it, and have also partially resolved II and III (both of which also exhibit out-of-plane distortions). All of these compounds were found to have low optical stability, but Turner *et al.* (1955) have prepared the optically active forms of 9 : 10-dihydro-3 : 4-5 : 6-dibenzophenanthrene (IV), which is more

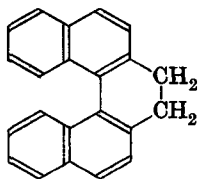

IV

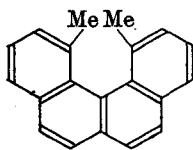

V

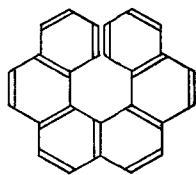

VI

optically stable than I, II and III. Newman *et al.* (1955, 1956) have prepared V and VI which, so far, are the most optically stable compounds of the intramolecular overcrowding type.

It will be noticed that in IV and VI the only way in which out-of-plane distortion can occur is through buckling of the molecule. The simplest

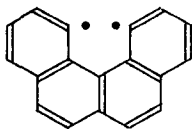

VII

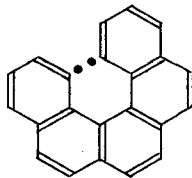

VIII

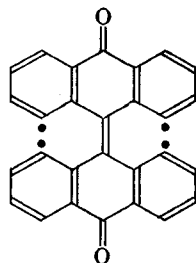

IX

molecule exhibiting overcrowding and consequent *out-of-plane buckling* of the molecule is 3 : 4-benzophenanthrene (VII); this has been shown to be non-planar by X-ray analysis (Schmidt *et al.*, 1954). Similarly, Robertson *et al.* (1954) have shown that VIII exhibits out-of-plane buckling.

Another point to note in connection with out-of-plane buckling is that the buckling is distributed over all the rings in such a manner as to cause the minimum distortion in any one ring. This distortion, which enables non-bonded carbon atoms to avoid being closer together than 3.0 Å (marked with dots in VII and VIII), forces some of the other carbon atoms to adopt an almost tetrahedral valency arrangement (the original hybridisation is trigonal), and this affects the physical and chemical properties of the molecule, *e.g.*, Coulson *et al.* (1955) have calculated that the deformation in VIII produces a loss of resonance energy of about 18 kg.cal./mole.

Just as benzene rings may suffer distortion, so can a molecule which owes its planarity to the presence of a double bond. Such an example is di-anthrnylidene (IX). The carbon atoms marked with dots are overcrowded (the distance between each pair is 2.9 Å), and the strain is relieved by a



rotation of about  $40^\circ$  around the olefinic double bond (Schmidt *et al.*, 1954). Even in such simple molecules as tiglic acid (X) the two methyl groups give rise to molecular overcrowding with the result that the  $\beta$ -methyl group

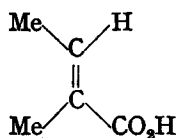

X

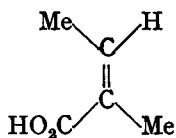

XI

appears to be displaced from the molecular plane, thereby relieving overcrowding which is also partly relieved by small distortions in bond angles. These results were obtained by Robertson *et al.* (1959) from X-ray studies, and these authors also showed similar distortions in angelic acid (XI).

In polynuclear aromatic hydrocarbons in which the strain tends to be overcome by out-of-plane displacements of substituents and out-of-plane ring buckling, these effects cause changes in the ultraviolet spectra, but it is not yet possible to formulate any correlating rules. NMR studies by Ried (1957) have shown a shift for the hydrogen atoms in positions 4 and 5 in phenanthrene itself. A similar phenomenon has been detected by Brownstein (1958) in 2-halogenodiphenyls, and the explanation offered is that the shift is due to the steric effect between the 2-halogen and the 2'-hydrogen atom.

Although molecular overcrowding is normally confined in the polynuclear type to systems containing three or more rings, nevertheless various substituted benzenes may also exhibit out-of-plane displacements of the substituents. Electron-diffraction studies of polyhalogenobenzenes suggest that such molecules are non-planar (Hassel *et al.*, 1947), whereas X-ray studies indicate that in the solid state such molecules are very closely or even exactly planar (Tulinsky *et al.*, 1958; Gafner *et al.*, 1960). Ferguson *et al.* (1959, 1961) have examined, by X-ray analysis, polysubstituted benzenes containing not more than one halogen atom, *e.g.*, *o*-chloro- and bromobenzoic acid, and 2-chloro-5-nitrobenzoic acid. In all three molecules the steric strain is relieved by small out-of-plane displacements of the exocyclic valency bonds in addition to the larger in-plane displacements of these bonds away from one another. Ferguson *et al.* (1962) have also shown that in 2-chloro-5-nitrobenzoic acid the carboxyl group is twisted further out of the benzene plane than in *o*-chlorobenzoic acid.

**§4. Racemisation of diphenyl compounds.** Since the optical activity of diphenyl compounds arises from restricted rotation, it might be expected that racemisation of these compounds would not be possible. In practice, it has been found that many optically active diphenyl compounds can be racemised under suitable conditions, *e.g.*, boiling in solution. The general theory of these racemisations is that heating increases the amplitude of the vibrations of the substituent groups in the 2 : 2' : 6 : 6'-positions, and also the amplitude of vibration of the two benzene rings with respect to each other, thereby permitting the substituent groups to slip by one another. Thus the nuclei pass through a common plane and hence the probability

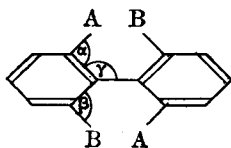

is that the final product will contain an equimolecular amount of the (+)- and (-)-forms. Westheimer (1946-1950) has assumed, in addition to the above bond-stretchings, that the angles  $\alpha$ ,  $\beta$  and  $\gamma$  are deformed, and also the benzene rings themselves are deformed during racemisation.

The foregoing theory of racemisation is analogous to Werner's theory for the racemisation of compounds which contain an asymmetric carbon atom. According to Werner (1904), the groups in the compound  $Cabde$  are set vibrating under the influence of heat, and if the amplitude of vibration becomes large enough, all four groups will become coplanar at some instant (Fig. 1). This planar structure is symmetrical, and when the molecule emerges from this condition, there is an equal chance of its doing so

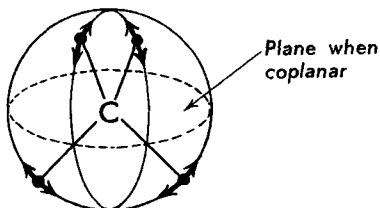
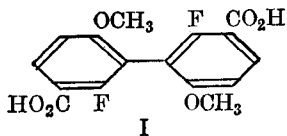

FIG. 5.1.

in the (+)- or (-)-configuration, *i.e.*, the molecule racemises. There is, however, a great deal of evidence against this mechanism in compounds of the type  $Cabde$ , *e.g.*, from spectroscopic data it appears that the bonds would break before the vibrations were large enough to permit a planar configuration to be reached. Furthermore, Kincaid and Henriques (1940), on the basis of calculations of the energy required for the inversion of molecules, were led to suggest that the molecule  $Cabde$  can only be racemised by the bonds actually breaking. Even so, this theory of racemisation appears to be the most reasonable one for the racemisation of diphenyl compounds. In this case, the amplitude of vibration does not have to be large in order to permit the *ortho*-groups to slip by one another. This is supported by the fact that it has been found that diphenyl compounds with small substituent groups racemise easily, whereas when the groups are large, racemisation is difficult or even impossible.

2 : 2' : 6 : 6'-Tetrasubstituted diphenyl compounds may be classified under three headings according to the nature of the substituent groups.

(i) *Non-resolvable*. These contain any of the following groups: hydrogen, methoxyl or fluorine. The volumes (*effective volumes*) of these groups are



too small to prevent rotation about the single bond. Thus 2 : 2'-difluoro-6 : 6'-dimethoxydiphenyl-3 : 3'-dicarboxylic acid, I, is non-resolvable.

(ii) *Resolvable, but easily racemised*. These must contain at least two amino-groups, or two carboxyl groups, or one amino- and one carboxyl

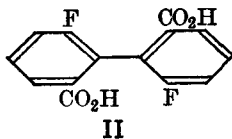

group; the remaining groups may be any of those given in (i) [but not hydrogen]. Thus 6 : 6'-difluorodiphenic acid, II, is resolvable, and is readily racemised.

(iii) *Not racemisable at all.* Diphenyl compounds which fall in this group are those which contain at least two nitro-groups; the other groups can be any of those given in (i)—but not hydrogen—and (ii). Thus 2 : 2'-difluoro-6 : 6'-dinitrodiphenyl, III, is resolvable, and cannot be racemised.

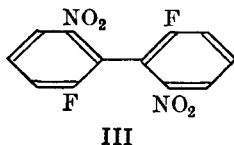

In addition to the size of the groups in the *ortho*-positions, the nature and position of other substituent groups also play a part in the rate of racemisation, *e.g.*, the rate of racemisation of IV is much slower than that of V (Adams *et al.*, 1932, 1934). Thus the nitro-group in position 3' has a much

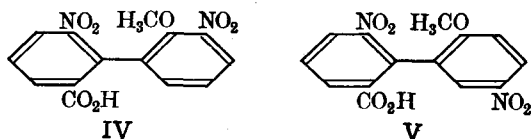

greater stabilising influence than in position 5'. The reason for this is uncertain, but one possible explanation is as follows. In VI, the methyl group of the methoxyl group is probably in the configuration shown. In VII, the nitro-group in the 3'-position would tend to force the methyl group away, the resulting configuration being somewhat as shown in VII;

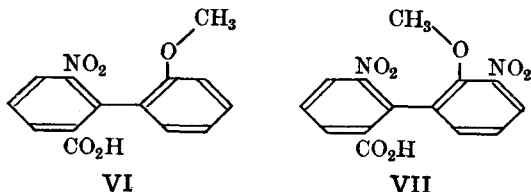

in this condition there would be greater interference between the methoxyl group and the two groups in the other benzene ring.

Adams *et al.* (1954, 1957) have examined the rate of racemisation of (VIII). The rate is increased when R is an electron-attracting group such

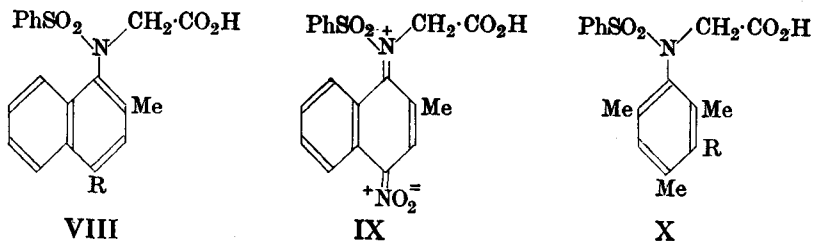

as  $\text{NO}_2$  or  $\text{CN}$ , and is decreased when R is an electron-releasing group such as Me or OMe. These results were explained as follows. With, *e.g.*,  $\text{R} = \text{NO}_2$ , (IX) contributes to the resonance hybrid as well as (VIII). The resonance hybrid therefore has increased  $\text{C}=\text{N}$  double bond character

and consequently it is now easier for the molecule to pass through a planar transition state. With, *e.g.*,  $R = \text{Me}$ , the C—N bond acquires far less double bond character than in its absence, and so it is more difficult for the molecule to pass through a planar transition state.

Adams *et al.* (1957, 1961) also examined the optical stability of compounds of type X; they found that the half-life was in the following order for R:  $\text{Me} < \text{Et} < i\text{-Pr} > t\text{-Bu}$ . If the effect of R were due merely to the inductive effect, then the unexpected value for *t*-Bu cannot be explained on this basis. The authors have proposed the following explanation. The *t*-Bu group, because of its large bulk, displaces the adjacent Me groups out of the plane of the benzene ring, thereby causing molecular overcrowding; this decreases the interference to rotation about the N—C (ring) bond (§3a). A molecular model of this compound showed such an interference. According to Bryan *et al.* (1960), it is possible that steric repulsion also operates to cause considerable angle distortion.

**§5. Evidence for the obstacle theory.** Evidence for the obstacle theory, *i.e.*, interference of groups, amounts to proving that the two benzene rings in optically active diphenyl compounds are not coplanar. A direct chemical proof for the non-coplanar configuration was given by Meisenheimer *et al.* (1927). The method was to unite the "obstacle groups" in optically active diphenyl compounds, thereby forming five- or six-membered rings. Now such systems are known to be planar, and hence optical activity should disappear; this was found to be so in practice. Meisenheimer started with 2 : 2'-diamino-6 : 6'-dimethyldiphenyl, resolved it and then carried out the following reactions on one of the enantiomorphs:

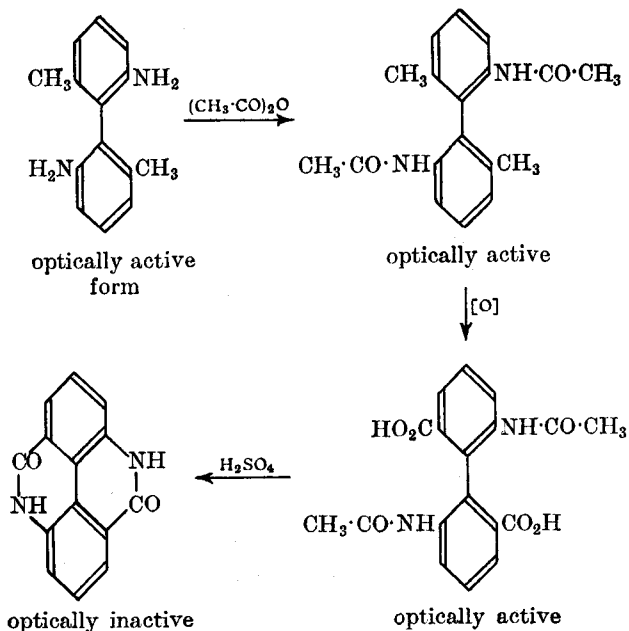

In all the optically active compounds, the rings *cannot* be coplanar, since if they were, the molecules would possess a centre or plane of symmetry. If the dilactam, however, is *not* planar, then it would possess no elements of symmetry, and consequently would be optically active. If the dilactam is planar, then it has a centre of symmetry, and consequently cannot be

optically active. This compound was, in fact, not optically active, and so must be planar.

According to Dhar (1932), X-ray analysis studies have shown that in the solid state the diphenyl molecule is planar. On the other hand, according to Robertson (1961), who also examined crystalline diphenyl by X-ray analysis, the molecule is *not* strictly planar. This non-planarity has been attributed to steric repulsion between the *o*-hydrogen atoms. Gas phase electron-diffraction studies indicate that the two rings are inclined at about  $45^\circ$  to one another (Brockway *et al.*, 1944; Bastiansen, 1949). In the solid state, crystal forces presumably tend to keep the diphenyl molecule almost planar.

### §6. STEREOCHEMISTRY OF THE ALLENES

Allenenes are compounds which have the general structure I.

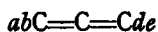

I

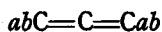

II

Examination of the space formula of compounds of this type shows that the molecule and its mirror image are not superimposable. The modern way of writing I is shown in Fig. 2. The two end carbon atoms are in a state of trigonal hybridisation, and the centre carbon atom is in the digonal state. Thus the centre carbon atom forms two  $\pi$ -bonds which are perpendicular to each other; in Fig. 2 the  $\pi_x$ -bond is perpendicular to the

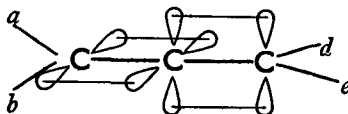
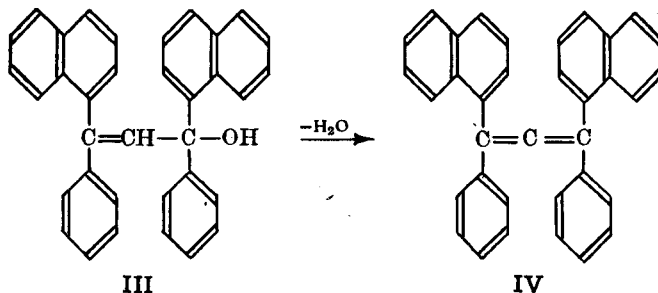

FIG. 5.2.

plane of the paper, and the  $\pi_y$ -bond is in the plane of the paper. In the trigonal state, the  $\pi$ -bond is perpendicular to the plane containing the three  $\sigma$ -bonds (see Vol. I, Ch. II); consequently the groups *a* and *b* lie in the plane of the paper, and the groups *d* and *e* in the plane perpendicular to the plane of the paper. This molecule does not possess a plane or centre of symmetry; this is also true for molecule II. Thus I and II will be resolvable (see also §3. IV).

The resolvability of allenenes was predicted by van't Hoff in 1875, but experimental verification was not obtained until 1935, when Mills and Maitland carried out a catalytic asymmetric dehydration on  $\alpha$ : $\gamma$ -di-1-naphthyl- $\alpha$ : $\gamma$ -diphenylallyl alcohol, III, to give the dinaphthyl-diphenyl-



allene, IV. When the dehydration was carried out with an optically inactive dehydrating catalyst, *e.g.*, *p*-toluenesulphonic acid, the racemic modification of the allene derivative was obtained. When, however, the alcohol

III was boiled with a one per cent. benzene solution of (+)-camphorsulphonic acid, a dextrorotatory allene was obtained. Similarly, (-)-camphorsulphonic acid gave a lævorotatory allene.

The first successful *resolution* of an allene derivative was carried out by Kohler *et al.*, also in 1935. Lapworth and Wechsler (1910) prepared  $\gamma$ -1-

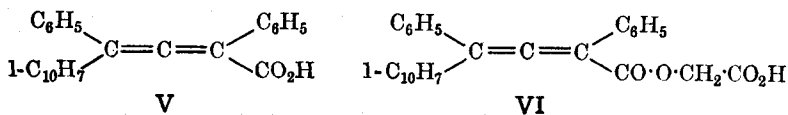

naphthyl- $\alpha$ :  $\gamma$ -diphenylallene- $\alpha$ -carboxylic acid, V, but failed to resolve it; they were unable to crystallise the salts with active bases. Kohler converted this acid into the glycollic acid ester, VI, and was then able to resolve VI by means of brucine.

Landor *et al.* (1959) have prepared an optically active allene by a method which correlates it stereochemically with a tetrahedrally asymmetric alcohol. An optically active acetylenic alcohol, on treatment with thionyl chloride, gave an optically active allene; the mechanism is possibly  $\text{S}_{\text{N}}2'$ .

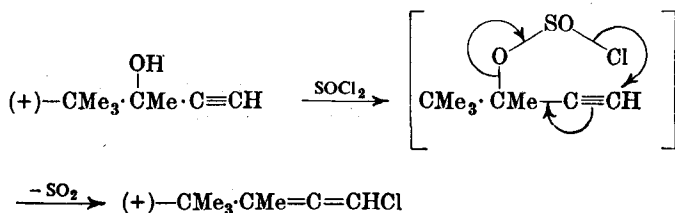

Landor *et al.* (1962) have also deduced the absolute configuration of the (+)-chloride by first determining the absolute configuration of the (+)-alcohol; the (*R*)-(-)-alcohol gave the (*S*)-(-)-allene.

Although allenes were not successfully resolved until 1935, compounds with a *similar* configuration were resolved as early as 1909. In this year,

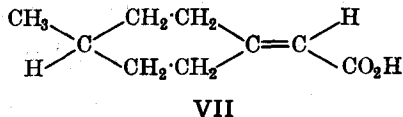

Pope *et al.* resolved 1-methylcyclohexylidene-4-acetic acid, VII; in this compound one of the double bonds of allene has been replaced by a six-membered ring, and the general shape of the allene molecule is retained.

It is interesting to note, in connection with allenes, that the antibiotic *mycomycin* has been shown to contain the allene grouping. *Mycomycin* is optically active, and is the only known natural compound which owes its optical activity to the presence of this grouping. Celmer and Solomons (1953) have shown that the structure of *mycomycin* is:



## §7. STEREOCHEMISTRY OF THE SPIRANS

If both double bonds in allene are replaced by ring systems, the resulting molecules are *spirans*. One method of naming spirans obtains the root name from the number of carbon atoms in the *nucleus*; this is then prefixed by the term "spiro", and followed by numbers placed in square brackets

which indicate the number of carbon atoms joined to the "junction" carbon atom. The positions of substituents are indicated by numbers, the

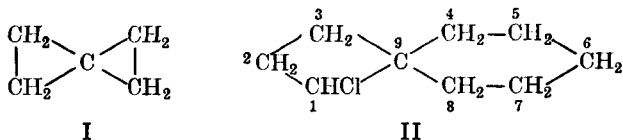

numbering beginning with the *smaller* ring and ending on the junction carbon atom; *e.g.*, I is spiro-[2 : 2]-pentane, II is 1-chlorospiro-[5 : 3]-nonane.

Examination of these formulæ shows that the two rings are perpendicular to each other, and hence suitable substitution will produce molecules with no elements of symmetry, thereby giving rise to optically active forms, *e.g.*, Mills and Nodder (1920, 1921) resolved the dilactone of benzophenone-2 : 2' : 4 : 4'-tetracarboxylic acid, III. In this molecule the two shaded

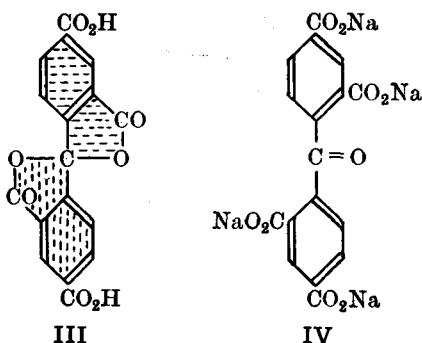

portions are perpendicular to each other, and consequently there are no elements of symmetry. When this compound is treated with sodium hydroxide, the lactone rings are opened to form IV, and the optical rotation disappears.

Bösesken *et al.* (1928) condensed penta-erythritol with pyruvic acid and obtained the spiro-compound V, which they resolved. Some other spiro-

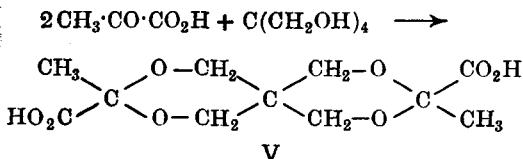

compounds that have been resolved are the spiro-heptane, VI (Backer *et al.*, 1928, 1929), the spiro-hydantoin, VII (Pope and Whitworth, 1931), and the spiroheptane, VIII (Jansen and Pope, 1932).

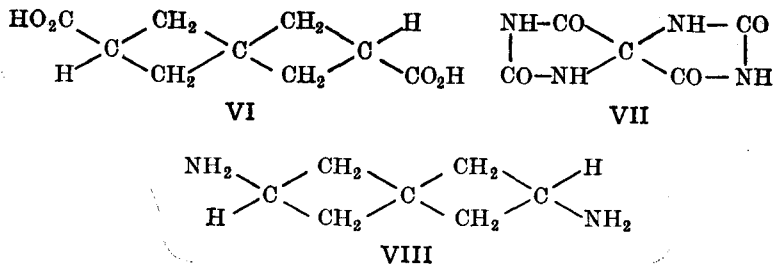





CHAPTER VI  
STEREOCHEMISTRY OF SOME ELEMENTS OTHER  
THAN CARBON

**§1. Shapes of molecules.** Many elements other than carbon form compounds which exhibit optical isomerism. Since the criterion for optical activity must be satisfied, *viz.* the molecule must not be superimposable on its mirror image, it therefore follows that the configurations of the various molecules can never be planar.

In Vol. I, Ch. II, the theory of shapes of molecules has been explained on the basis that all electrons (shared and unshared) in the valency shell of the central atom arrange themselves in pairs of opposite spin which keep as far apart as possible. Furthermore, it was assumed that deviations from regular shapes arise from electrostatic repulsions between electron pairs in the valency shell as follows:

lone-pair—lone-pair > lone-pair—bond-pair > bond-pair—bond-pair.

It was also assumed that a double (and triple) bond repels other bond-pairs more than does a single bond. The following two tables illustrate these ideas.

*Shapes of molecules containing single bonds*

Number of electrons in valency shell	Number of bonding pairs	Number of lone-pairs	Hybrid orbitals used	Shape of molecule	Examples
2	2	0	$sp$	Linear	HgCl <sub>2</sub>
3	3	0	$sp^2$	Triangular plane	BCl <sub>3</sub>
4	4	0	$sp^3$	Tetrahedron	CH <sub>4</sub>
	3	1	$sp^3$	Trigonal pyramid	NH <sub>3</sub>
	2	2	$sp^3$	V-shape	H <sub>2</sub> O
5	5	0	$sp^3d$	Trigonal bipyramid	PCl <sub>5</sub>
6	6	0	$sp^3d^2$	Octahedron	SF <sub>6</sub>

When dealing with molecules containing multiple bonds (treated in terms of  $\sigma$ - and  $\pi$ -bonds), the shapes may also be predicted in a similar fashion if it is assumed that the electron-pairs (2 in a double and 3 in a triple bond) occupy only *one* of the positions in the various arrangements described in the above table, *i.e.*, a multiple bond is treated as a "single" bond. This means that the shape of the molecule is determined by the number of  $\sigma$ -bonds and lone-pairs only; the  $\pi$ -bonds are "fitted in" afterwards (p. 144).

**§2. STEREOCHEMISTRY OF NITROGEN COMPOUNDS**

According to the electronic theory of valency, nitrogen can be trivalent or quadricovalent unielectrovalent; in both of these states nitrogen, as the "central" atom, can exhibit optical activity.

**§2a. Quaternary ammonium salts.** Originally, the valency of nitrogen in quaternary ammonium salts was believed to be quinquevalent; later,

## Shapes of molecules containing multiple bonds

Total number of $\sigma$ -bonds and lone-pairs	Number of $\sigma$ -bonds	Number of lone-pairs	Shape of molecule	Examples
2	2	0	Linear	$O=C=O$ ; $H-C\equiv N$
3	3	0	Triangular plane	$\begin{array}{c} O \\ \diagdown \\ S \\ \diagup \\ O \end{array}$ $\begin{array}{c} Cl \\ \diagdown \\ C \\ \diagup \\ Cl \end{array}$
	2	1	Triangular plane	$\begin{array}{c} \cdot \\ \diagdown \\ S \\ \diagup \\ O \end{array}$ $\begin{array}{c} \cdot \\ \diagdown \\ N \\ \diagup \\ O \end{array}$
4	4	0	Tetrahedron	$\begin{array}{c} O \\ \diagdown \\ S \\ \diagup \\ OH \end{array}$ $\begin{array}{c} OH \\ \diagdown \\ P \\ \diagup \\ Cl \\ Cl \\ Cl \end{array}$
	3	1	Trigonal pyramid	$\begin{array}{c} \cdot \\ \diagdown \\ S \\ \diagup \\ Cl \\ Cl \end{array}$

however, it was shown that one valency was different from the other four. Thus, using the formula,  $[Nabcd]^+X^-$ , for quaternary ammonium salts, and assuming that the charge on the nitrogen atom has no effect on the configuration of the cation, the cation may be considered as a five-point system similar to that of carbon in compounds of the type  $Cabde$ . This similarity is based on the assumption that the four valencies in the ammonium ion are equivalent, and this assumption is well substantiated experimentally and also theoretically. Hence there are three possible configurations for the cation  $[Nabcd]^+$ , I, II and III (cf. §3a. II). If the cation is planar (I),

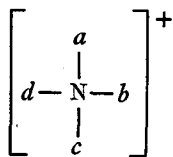

I

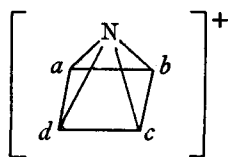

II

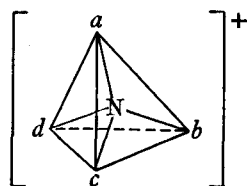

III

then it would not be resolvable; it would be resolvable, however, if the configuration is pyramidal (II) or tetrahedral (III). Le Bel (1891) claimed to have partially resolved *isobutylethylmethylpropylammonium chloride*, IV, by means of *Penicillium glaucum* (cf. §10 iii. II), but later work apparently

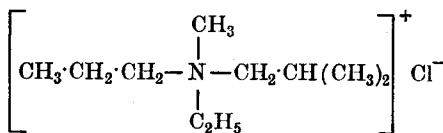

IV

showed this was wrong. The first definite resolution of a quaternary ammonium salt was that of Pope and Peachey (1899), who resolved allylbenzylmethylphenylammonium iodide, V, by means of (+)-bromocamphor-sulphonic acid. This was the first case of optical activity due to a "central"

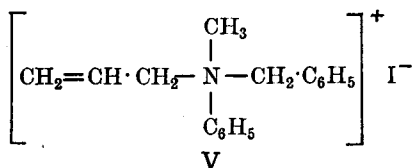

atom other than carbon. This resolution was then followed by the work of Jones (1905), who resolved benzylethylmethylphenylammonium iodide. Thus the ammonium ion cannot be planar, but must be either pyramidal or tetrahedral. Bischoff (1890) had proposed a pyramidal structure, and this configuration was supported by Jones (1905) and Jones and Dunlop (1912). On the other hand, Werner (1911) had suggested the tetrahedral configuration, and this was supported by Neagi (1919) and Mills and Warren (1925). It was, however, Mills and Warren who gave the most conclusive evidence that the configuration is tetrahedral. Their evidence is based on the following argument. Compounds of the type  $abC=C=Cab$  are resolvable since carbon is "tetrahedral" (see allenes, §6. V), and if nitrogen is also "tetrahedral", then the compound  $abC=N=Cab$  should be resolvable, but will not be resolvable if the nitrogen is pyramidal. Mills and Warren prepared 4-carbethoxy-4'-phenylbis(piperidinium-1:1'-spiran bromide), and resolved it. If the configuration of this molecule is VI, *i.e.*, a spiran, then it possesses no elements of symmetry, and hence will be resolvable; if the configuration is VII (*i.e.*, pyramidal), then it will possess a vertical plane of symmetry,

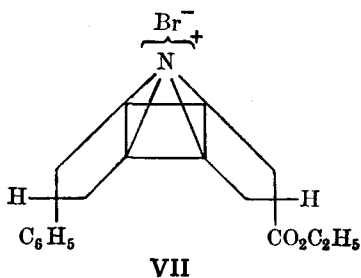
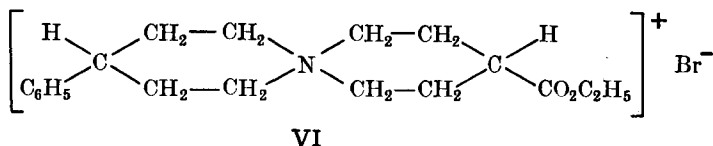

and hence will be optically inactive. Since the compound was resolved, the configuration must be tetrahedral, *i.e.*, VI. This tetrahedral configuration has been confirmed by physico-chemical studies (see §2b). More recently, Hanby and Rydon (1945) have shown that the diquaternary salts of dimethylpiperazine exhibit geometrical isomerism, and this is readily explained on the tetrahedral configuration of the four nitrogen valencies (*cf.* cyclohexane, §11. IV).

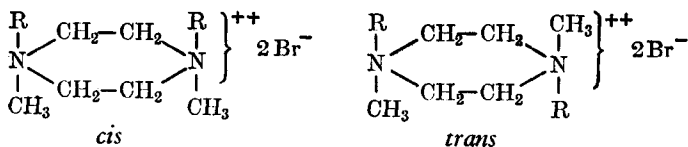

It has already been mentioned (§6. II) that McCasland and Proskow (1956) prepared a spiro-nitrogen compound which contained no plane or centre of symmetry, but was nevertheless optically inactive because it contained an alternating axis of symmetry. We shall now examine this compound (VIII;  $Y^-$  is the *p*-toluenesulphonate ion) in more detail. This molecule can exist in four diastereoisomeric forms, three active and one

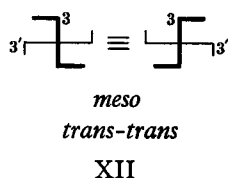
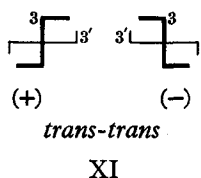
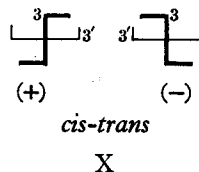
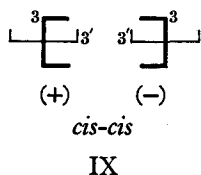
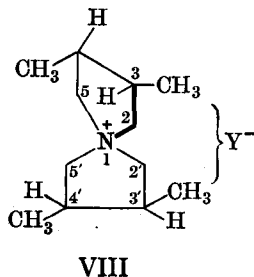

*meso*. All four have been prepared, and are depicted as shown in IX, X, XI and XII. The co-axis of each spiran is assumed to be perpendicular to the plane of the paper, and the intersecting lines represent the two rings. The short appendages show whether the two substituents (methyl) are *cis* or *trans*. The ring nearer the observer's eye is indicated by the heavy line, and a uniform orientation has been adopted: the front ring is always vertical, and the back horizontal ring with at least one substituent directed upwards and the *cis* ring placed at the back in the case of the *cis/trans* ring combination.

Racemisation of optically active quaternary ammonium salts is far more readily effected than that of carbon compounds containing an asymmetric carbon atom, *i.e.*, compounds of the type *Cabde*. The mechanism of the racemisation of the ammonium salts is believed to take place by dissociation into the amine, which then rapidly racemises (§2c):

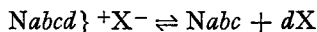

Recombination of the racemised amine with  $dX$  results in the racemisation of the quaternary compound (see §4a).

**§2b. Tertiary amine oxides.** In tertiary amine oxides, *abcNO*, the nitrogen atom is joined to four different groups, and on the basis that the configuration is tetrahedral, such compounds should be resolvable. In

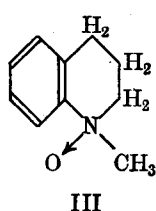
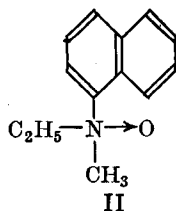
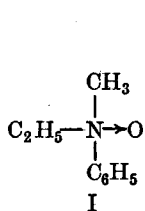

1908, Meisenheimer resolved ethylmethylphenylamine oxide, I, and this was then followed by the resolution of other amine oxides, *e.g.*, ethylmethyl-1-naphthylamine oxide, II, and kairiline oxide, III.

The evidence in favour of the structure IV as opposed to that of V is based on dipole moment measurements and on the fact that such compounds can be resolved. It should be noted that the pyramidal structure would

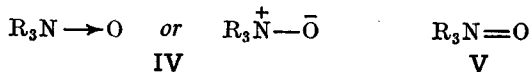

also account for the optical activity of these compounds as well as the tetrahedral. Consequently these compounds cannot be used as a criterion for the pyramidal or tetrahedral configuration of the nitrogen atom. However, by analogy with the quaternary ammonium salts, the configuration of amine oxides may be accepted as tetrahedral. Further evidence for this is as follows. The electronic configuration of nitrogen is  $(1s^2)(2s^2)(2p^3)$ . For nitrogen to be quinquevalent, the "valence state" will be derived from the arrangement  $(1s^2)(2s)(2p^3)(3s)$ . Now the amount of energy required to promote an electron from a 2s to a 3s orbital appears to be too large for it to occur, and consequently nitrogen is (apparently) never quinquevalent. The valence state of nitrogen is thus achieved by the loss of one 2s electron and then hybridisation of the 2s and  $2p^3$  orbitals, *i.e.*, nitrogen becomes quadricovalent unielectrovalent, and the four bonds ( $sp^3$  bonds) are arranged tetrahedrally. The charged nitrogen atom is isoelectronic with carbon, and so one can expect the formation of similar bonds. Furthermore, evidence obtained by an examination of the vibration frequencies of the ammonium ion indicates that the configuration of this ion is tetrahedral.

Recently, Bennett and Glynn (1950) have obtained two geometrical isomers of 1:4-diphenylpiperazine dioxide; this is readily explained on the tetrahedral configuration of nitrogen (*cf.* §2a).

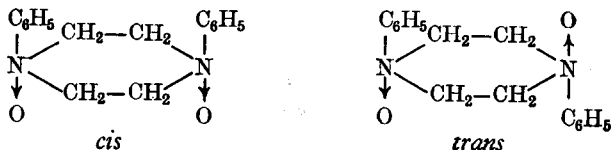

§2c. Amines. If the tertiary amine molecule, *Nabc*, is planar, it will be superimposable on its mirror image, and therefore cannot be optically active. All attempts to obtain tertiary amines in optically active forms have failed up to the present time, *e.g.*, Kipping and Salway (1904) treated secondary amines,  $\text{R}\cdot\text{NH}\cdot\text{R}'$ , with  $(\pm)$ -benzylmethylacetyl chloride; if the three valencies of the nitrogen atom are not planar, then the base will be a racemic modification, and on reaction with the acid chloride, the following four substituted amides should be formed:  $\text{B}_+\text{A}_+$ ,  $\text{B}_-\text{A}_-$ ,  $\text{B}_+\text{A}_-$ ,  $\text{B}_-\text{A}_+$ , *i.e.*, a mixture of two pairs of enantiomorphs. Experiments carried out with, *e.g.*, methylaniline and benzylaniline gave *homogeneous* products. Meisenheimer *et al.* (1924) attempted to resolve *N*-phenyl-*N*-*p*-tolylantranilic acid, I, and also failed. In view of these failures, it would thus appear that

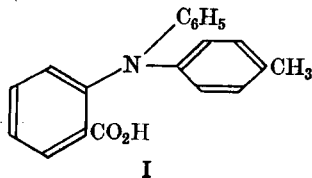

the tertiary amine molecule is planar. Physico-chemical methods, *e.g.*, dipole moment measurements, infra-red absorption spectra studies, etc., have, however, shown conclusively that the configuration of ammonia and of tertiary amines is tetrahedral. Thus ammonia has been shown to have a dipole moment of 1.5 D; had the molecule been planar, the dipole moment would have been zero. Furthermore, the nitrogen valency angles in, *e.g.*, trimethylamine have been found to be  $108^\circ$ , thus again showing that the amine molecule is not planar. Why, then, cannot tertiary amines be resolved? Is it a question of experimental technique, or is there something inherent in the tertiary amine molecule that makes it impossible to be resolved? Meisenheimer (1924) explained the failure to resolve as follows. In the tertiary amine molecule, the nitrogen atom oscillates rapidly at right angles above and below the plane containing the groups *a*, *b* and *c* (see Fig. 1); II and III are the two extreme forms, and they are mirror

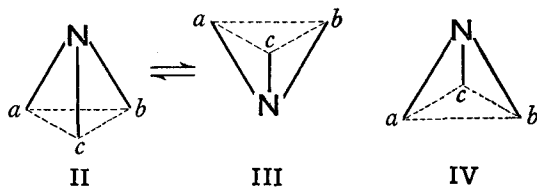

FIG. 6.1.

images and not superimposable (IV is III "turned over", and it can be seen that IV is the mirror image of II). Thus this oscillation brings about very rapid optical inversion. This oscillation theory is supported by evidence obtained from the absorption spectrum of ammonia (Barker, 1929; Badger, 1930), and the frequency of the oscillation (and therefore the inversion) has been calculated to be  $2.3 \times 10^{10}$  per second (Cleaton *et al.*, 1934).

In the foregoing explanation for the racemisation of amines, it has been assumed that the nitrogen valency angles and the bond lengths change. This inversion of amines, however, is better represented as an "umbrella" switch of bonds, *i.e.*, the bond lengths remain unaltered and only the nitrogen valency angles change. This interpretation is more in keeping with the facts, *e.g.*, as the groups *a*, *b* and *c* increase in weight, the frequency of the inversion of the molecule decreases.

Theoretical calculations have shown that an optically active compound will not racemise spontaneously provided that the energy of activation for the change of one enantiomorph into the other is greater than 12-15 kg.cal./mole. The two forms, II and III, have been shown to be separated by an energy barrier of about 6 kg.cal./mole, and consequently the two forms are readily interconvertible.

It has already been mentioned (§2b) that the electronic configuration of the nitrogen atom is  $(1s^2)(2s^2)(2p^3)$ . According to Hund's rule, electrons tend to avoid being in the same orbital as far as possible (see Vol. I, Ch. II). Thus, in ammonia and its derivatives, bonds are formed by pairing with the three single orbitals  $2p_x$ ,  $2p_y$  and  $2p_z$ . Since these are mutually at right angles, the configuration of the ammonia molecule will be a *trigonal pyramid*, *i.e.*, a pyramid with a triangular base, with the nitrogen atom situated at one corner. Oscillation of the nitrogen atom brings about inversion in the tertiary amines, *Nabc*. This picture of the configuration of the ammonia molecule, however, requires modification. The valency angles in ammonia have been shown to be approximately  $107^\circ$ . The deviation from the value of  $90^\circ$  (on the assumption that the bonds are pure  $2p$  orbitals) is too great to be accounted for by repulsion between the hydrogen atoms. As we have seen (§1), according to modern theory the orbitals in ammonia

are  $sp^3$ , one orbital being occupied by the lone-pair. The deviation of the valency angle of  $107^\circ$  from the tetrahedral value of  $109^\circ 28'$  has been explained by the greater repulsion between a lone-pair and a bond-pair than between a bond-pair and a bond-pair.

In view of what has been said above, it appears that tertiary amines of the type *Nabc* will never be resolved. Now, Kincaid and Henriques (1940), on the basis of calculations of the energy of activation required for the inversion of the amine molecule, arrived at the conclusion that tertiary amines are incapable of resolution because of the ease of racemisation, but if the nitrogen atom formed a part of a *ring* system, then the compound would be sufficiently optically stable to be isolated. This prediction was confirmed by Prelog and Wieland (1944), who resolved Tröger's base, V,

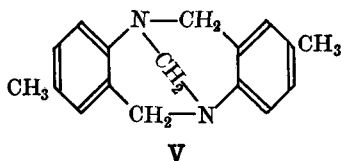

by chromatographic adsorption on D-lactose (*cf.* §10 vi. II). In this compound, the nitrogen is tervalent, but the frequency of oscillation has been brought to zero by having the three valencies of nitrogen as part of the ring system.

Roberts *et al.* (1958) have examined *N*-substituted ethyleneimines (see Vol. I) by NMR spectroscopy. Their results support the "umbrella" switch of bonds, and these authors believe that optical resolution of this type of compound may be possible below  $-50^\circ$ .

§2d. Oximes. In 1883, Goldschmidt found that benzil dioxime,

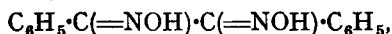

could be converted into an isomeric form by boiling it in ethanolic solution; and then, in 1889, Meyer *et al.* isolated a third isomer of this compound. Beckmann, also in 1889, found that benzaldoxime existed in two isomeric forms, and from that time many aromatic oximes were shown to exist in two isomeric forms. The existence of isomerism in aromatic oximes was first explained by structural isomerism, two of the following four structures corresponding to the two isomers (where R is an alkyl or an aryl group); II is the modern way of writing the nitron structure (originally, it was

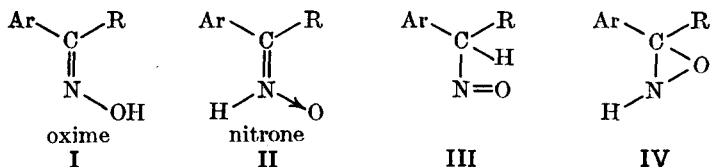

written with quinquivalent nitrogen, the nitrogen being linked to the oxygen by a double bond). Hantzsch and Werner (1890), however, suggested that the isomerism of the oximes was geometrical and not structural. According to these authors, nitrogen is tervalent (in oximes), and is situated at one corner of a tetrahedron with its three valencies directed towards the other three corners; consequently the three valencies are not coplanar (*cf.* tertiary amines). These authors also assumed that there is no free rotation about the  $C=N$  double bond (*cf.* §2. IV), and therefore proposed configurations V and VI for the two isomers:

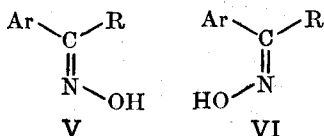

Many facts are in favour of geometrical isomerism, *e.g.*,

- (i) If  $\text{Ar} = \text{R}$ , then isomerism disappears.
- (ii) III and IV would be optically active; this is not found to be so in practice.
- (iii) Absorption spectra measurements show that the two isomers have identical structures.

As pointed out above, Hantzsch and Werner chose structure I as the formula for the oximes, but examination of II shows that this would also satisfy the requirements for geometrical isomerism; structure I was chosen because oximes were known to contain the group  $>\text{C}=\text{NOH}$ . Later work, however, has shown that the problem is not so simple as this; methylation of an oxime (with methyl sulphate) usually produces a mixture of two compounds, one of which is the *O*-methyl ether, VII, and the other the *N*-methyl ether, VIII. These two are readily distinguished by the fact



that on heating with hydriodic acid, VII gives methyl iodide, whereas VIII gives methylamine. Thus, Semper and Lichtenstadt (1918) obtained *four* methyl derivatives of phenyl *p*-tolyl ketoxime, IX–XII. On treatment

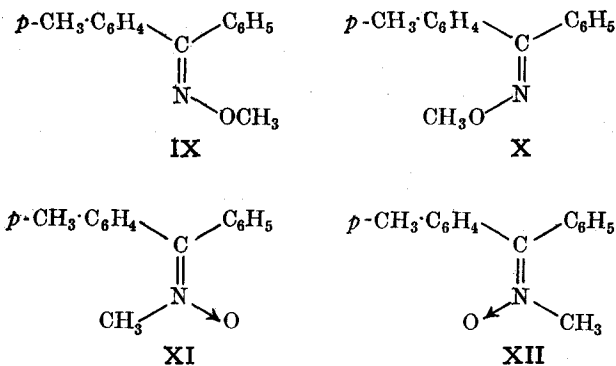

with concentrated hydriodic acid, two of these compounds gave methyl iodide, and therefore correspond to the *O*-methyl derivatives, IX and X; the other two compounds gave methylamine, and therefore correspond to the *N*-methyl derivatives, XI and XII. Thus it appears that oximes can exist in forms I and II. Brady (1916) considered that oximes in solution are a tautomeric mixture of I and II (*oximino-nitrono diad system*). Ultra-violet absorption spectra studies show that the spectra of the oximes are the same as those of the *O*-methyl ethers, whereas those of the *N*-methyl ethers are entirely different. Hence, if oximes are tautomeric mixtures of I and II, the equilibrium must lie almost completely on the oxime side, *i.e.*,



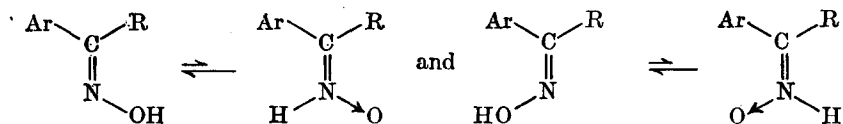

It is possible, however, that none of the nitrono form is present, but its methyl derivative is formed during the process of methylation. If we assume that methyl sulphate provides methyl carbonium ions, then it is possible that these ions attack the nitrogen atom (with its lone-pair) or the oxygen atom (with its two lone-pairs). This would result in the formation of the *N*- and *O*-methyl ethers, without having to postulate the existence of the oximino-nitrono tautomeric system.

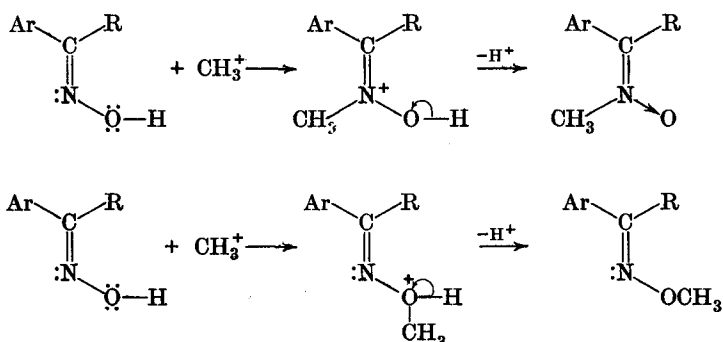
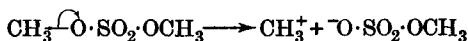

In the foregoing account, the geometrical isomerism of the oximes is based on the assumption that the nitrogen atom, in the oximino-form, exhibits the trigonal pyramidal configuration. Further proof for this configuration is obtained from the examination of the oxime of *cyclohexanone-4-carboxylic acid* (XIIIa or b). If the three nitrogen valencies are non-planar (*i.e.*, the

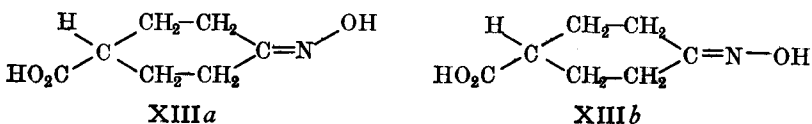

N—O bond is not collinear with the C=N double bond), the configuration is XIIIa, and it will therefore be optically active. If, however, the three nitrogen valencies are coplanar and symmetrically placed, then the configuration will be XIIIb, and this will not be optically active, since it possesses a plane of symmetry. Mills and Bain (1910) prepared this oxime and resolved it; hence its configuration must be XIIIa. This is readily explained on the modern theory of valency (§2c).

**§2e. Nomenclature of the oximes.** In oxime chemistry the terms *syn* and *anti* are used instead of the terms *cis* and *trans*. When dealing with aldoximes, the *syn*-form is the one in which both the hydrogen atom and the hydroxyl group are on the same side; when these groups are on opposite sides, the configuration is *anti*. Thus I is *syn*- and II is *anti*-benzaloxime. With ketoximes, the prefix indicates the spatial relationship between the

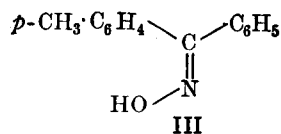
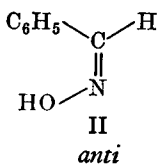
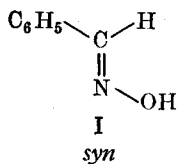

first group named and the hydroxyl group (cf. §4. IV). Thus III may be named as *syn-p*-tolyl phenyl ketoxime or *anti*-phenyl *p*-tolyl ketoxime.

**§2f. Determination of the configuration of aldoximes.** As we have seen, aromatic aldoximes can be obtained in two geometrical isomeric forms, the *syn* and the *anti*. Aliphatic aldoximes, however, appear to occur in one form only, and this is, apparently, the *anti*-form. The problem, then, with aromatic aldoximes, is to assign configurations to the stereoisomeric forms. The two forms (of a given aldoxime) resemble each other in many ways, but differ very much in the behaviour of their acetyl derivatives towards aqueous sodium carbonate. The acetyl derivative of one isomer regenerates the aldoxime; this form is known as the  $\alpha$ -isomer. The other isomer, however, eliminates a molecule of acetic acid to form an aryl cyanide; this form is known as the  $\beta$ -isomer. Hantzsch and Werner (1890) suggested that the  $\beta$ -form readily eliminates acetic acid because the hydrogen atom and the acetoxy-group are close together, *i.e.*, the  $\beta$ -isomer is the *syn*-form. Such a view, however, is contrary to many experimental results (cf. §5 xi. IV), *i.e.*, the experimental results are:

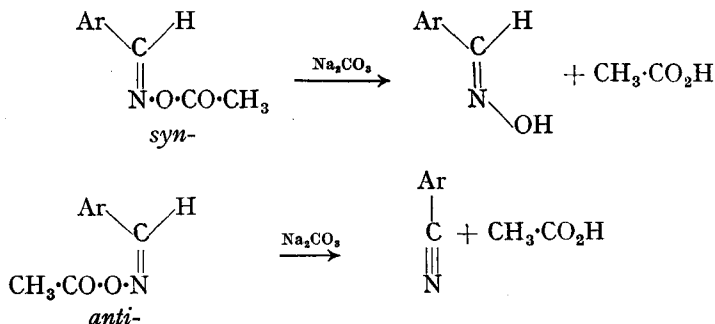

Brady and Bishop (1925) found that only one of the two isomers of 2-chloro-5-nitrobenzaloxime readily gave ring closure on treatment with

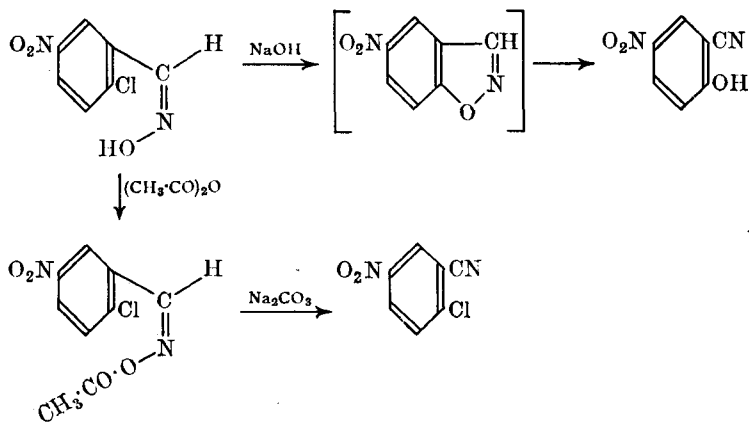

sodium hydroxide. It therefore follows that this form is the *anti*-isomer (*cf.* method of cyclisation, §5 i. IV). It was also found that it was this isomer that gave the cyanide on treatment with acetic anhydride followed by aqueous sodium carbonate. Thus *anti*-elimination must have occurred, *i.e.*, the  $\beta$ -isomer is the *anti*-form. These reactions may be formulated as shown at foot of previous page.

Actually, the ring compound produced, the 5-nitrobenziso-oxazole, is unstable, and rearranges to nitrosalicylonitrile.

In a similar manner, Meisenheimer (1932) found that of the two isomeric 2 : 6-dichloro-3-nitrobenzaloximes, it was the *anti*-isomer that gave ring closure, and was also the one that gave the cyanide. Hence, if *anti*-elimination is used as the criterion for these reactions, the configurations

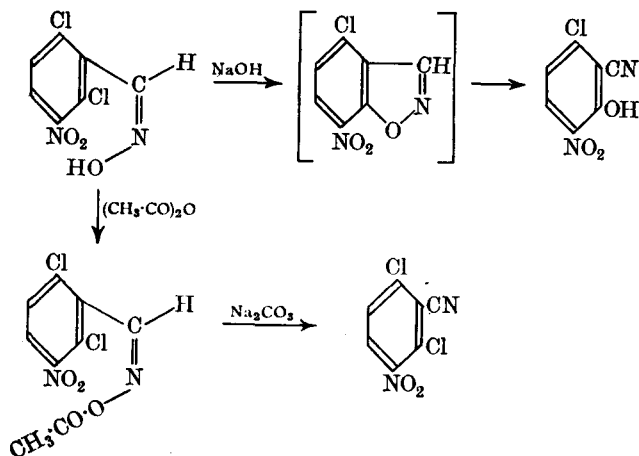

of the *syn*- and *anti*-forms can be determined. It might be noted here, in passing, that since the *syn*-form was originally believed to form the cyanide, the configurations of the isomers in the literature up to 1925 (*i.e.*, before Brady's work) are the reverse of those accepted now.

**§2g. Determination of the configuration of ketoximes.** The configurations of ketoximes have been mainly determined by means of the **Beckmann rearrangement** (1886). Aromatic ketoximes, *i.e.*, ketoximes containing at least one aromatic group, occur in two forms; aliphatic ketoximes appear to occur in one form only. When treated with certain acidic reagents such as sulphuric acid, acid chlorides, acid anhydrides, phosphorus pentachloride, etc., ketoximes undergo a molecular rearrangement, resulting in the formation of an acid amide:

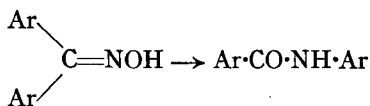

This rearrangement is known as the *Beckmann rearrangement* or *Beckmann transformation*. The best method is to treat an ethereal solution of the oxime with phosphorus pentachloride at a temperature below  $-20^\circ$ . On the other hand, Horning *et al.* (1952) have found that a very good method for effecting the Beckmann rearrangement is to heat the oxime in polyphosphoric acid at  $95^\circ$  to  $130^\circ$ .

Hantzsch (1891) suggested that the course of the rearrangement indicated

the configuration of the oxime, and assumed that the *syn*-exchange of groups occurred since they were closer together in this isomer. This, again, was shown experimentally to be the reverse, *i.e.*, it is the *anti*-rearrangement that occurs, and not the *syn*; thus:

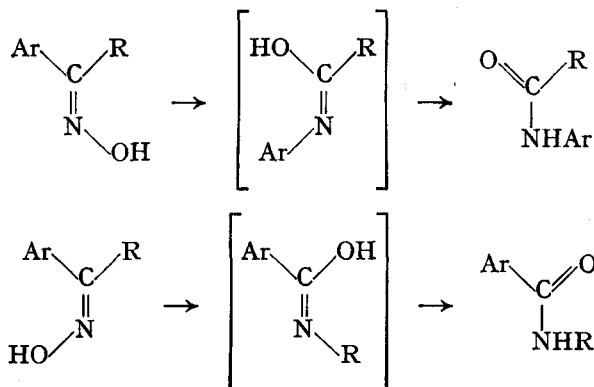

Meisenheimer (1921) subjected triphenyl*iso*-oxazole, I, to ozonolysis, and thereby obtained the benzoyl-derivative of *anti*-phenyl benzil monoxime, II. This configuration is based on the reasonable assumption that the ozonolysis proceeds without any change in configuration. Furthermore, the monoxime designated the  $\beta$ -isomer gave II on benzylation, and so the configuration

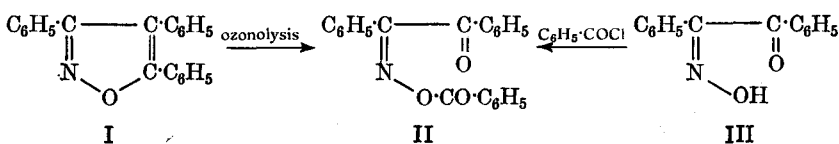

of the  $\beta$ -isomer, III, is determined. Meisenheimer then subjected this  $\beta$ -oxime (*i.e.*, the *anti*-phenyl oxime) to the Beckmann rearrangement, and obtained the anilide of benzoylformic acid, IV; thus the exchange of groups

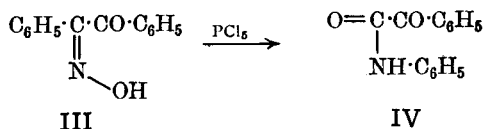

must occur in the *anti*-position. The configuration of the  $\beta$ -monoxime, III, is confirmed by the fact that it may be obtained directly by the ozonolysis of 3:4-diphenyl*iso*-oxazole-5-carboxylic acid, V (Kohler, 1924). Meisenheimer *et al.* (1925) also demonstrated the *anti*-rearrangement as follows.

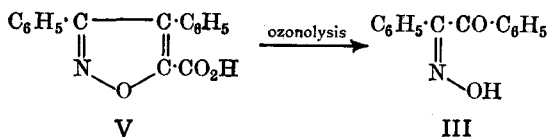

The  $\alpha$ -oxime of 2-bromo-5-nitroacetophenone is unaffected by sodium hydroxide, whereas the  $\beta$ -isomer undergoes ring closure to form 3-methyl-5-nitrobenz*iso*-oxazole; thus the  $\alpha$ -oxime is the *syn*-methyl isomer VI, and the  $\beta$ -oxime the *anti*-methyl isomer VII. When treated with sulphuric acid or phosphorus pentachloride, the  $\alpha$ -oxime underwent the Beckmann

rearrangement to give the *N*-substituted acetamide; thus the exchange occurs in the *anti*-positions.

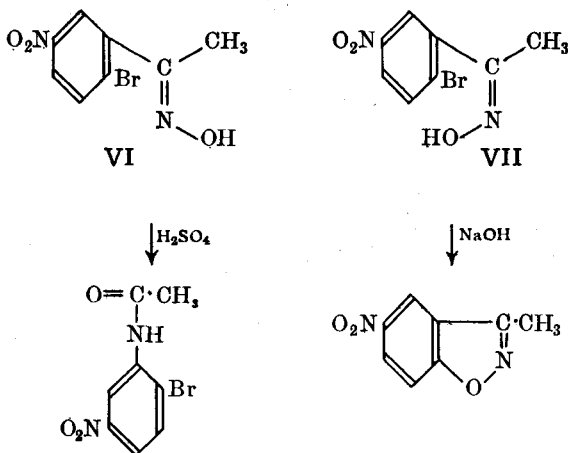

Further evidence for the *anti*-exchange of groups in the Beckmann rearrangement has been obtained by studying the behaviour of compounds exhibiting restricted rotation about a single bond, *e.g.*, Meisenheimer *et al.* (1932) prepared the two isomeric oximes of 1-acetyl-2-hydroxynaphthalene-3-carboxylic acid, VIII and IX, and of these two forms only one was resolvable. This resolvable isomer must therefore be IX, since asymmetry

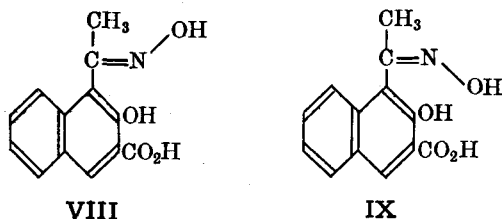

due to restricted rotation is possible only with this form (*cf.* §3. V). Meisenheimer found that the ethyl ester of IX, on undergoing the Beckmann rearrangement, gave the amide  $\text{Ar}\cdot\text{CO}\cdot\text{NH}\cdot\text{CH}_3$  (where Ar is the naphthalene part of the molecule), whereas the ethyl ester of VIII gave the amide  $\text{CH}_3\cdot\text{CO}\cdot\text{NH}\cdot\text{Ar}$ . These results are in agreement with the *anti*-exchange of groups in each case.

Thus the evidence is all in favour of the *anti*-exchange of groups in the Beckmann rearrangement, and hence by using this principle, the Beckmann rearrangement may be used to determine the configuration of ketoximes.

An interesting application of the Beckmann rearrangement is in the formation of heterocyclic rings, *e.g.*, when cyclopentanone oxime is subjected to the Beckmann rearrangement, the nitrogen atom enters the ring (thus producing ring expansion) to form 2-piperidone (see also §2h).

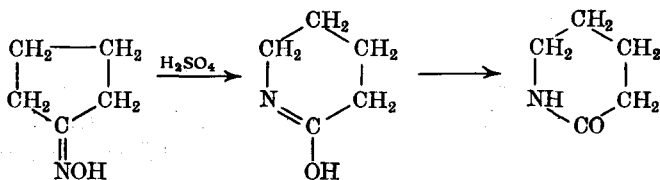

On the other hand, Hill *et al.* (1956) have shown that the oximes of some spiro-ketones undergo abnormal Beckmann rearrangements in the presence of polyphosphoric acid, *e.g.*, spiro-[4:4]-nonanone-1-oxime gives hydrind-8:9-en-4-one:

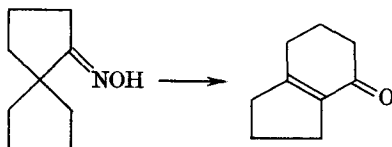

Although aliphatic ketoximes are not known in two isomeric forms, some may produce two products when subjected to the Beckmann rearrangement, *e.g.*, the oxime of pentan-2-one gives *N*-propylacetamide and *N*-methylbutyramide. The reason for this is uncertain; possibly oximes of this type are actually a mixture of the two forms; or alternatively, they exist in one

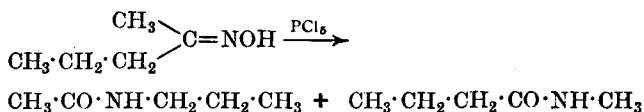

stable form which, during the Beckmann rearrangement, is partially converted into the labile form which then undergoes the rearrangement (*cf.* benzaldoxime, below).

Whereas the majority of ketoximes undergo the Beckmann rearrangement, it appears that few aldoximes do so. In an attempt to prepare quinoline by the dehydration of cinnamaldoxime with phosphorus pentoxide, Bamberger and Goldschmidt (1894) actually obtained *iso*quinoline; the formation of the latter compound and not the former can only be reasonably explained on the assumption that the oxime first undergoes the Beckmann rearrangement, and the rearranged product then undergoes ring closure to form *iso*quinoline. Recently, Horning *et al.* (1952) have shown that aldoximes can

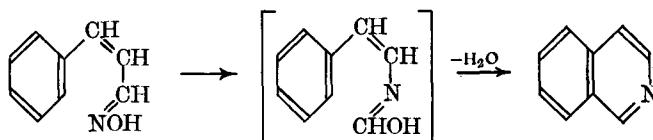

be made to undergo the Beckmann rearrangement under the influence of polyphosphoric acid, *e.g.*, *syn*-benzaldoxime gives a mixture of formanilide and benzamide, the latter being produced by the conversion of the *syn*-

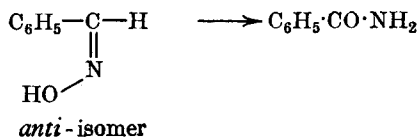
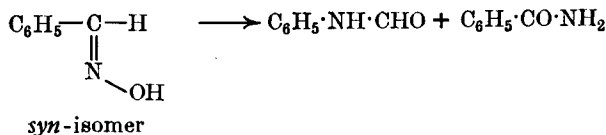

form into the *anti*; *anti*-benzaldoxime gives benzamide only. These results are in agreement with the configurations obtained by other methods (see §2f).

**§2h. Mechanism of the Beckmann rearrangement.** This rearrangement is an example of the 1,2-shift in which the migration origin is carbon and the migration terminus is nitrogen (see also 1,2-shifts, Vol. I, Ch. V). As we have seen above (§2g), an integral part of the rearrangement is the *anti* migration of the group. Since the oxime itself does not rearrange, it is reasonable to suppose that some intermediate is formed between the oxime and the reagent used to effect the rearrangement, and it is this intermediate which then rearranges. Kuhara *et al.* (1914, 1916) prepared the benzenesulphonate of benzophenone oxime and showed that this readily underwent rearrangement in neutral solvents in the absence of any acid catalyst to give an isomeric compound which, on hydrolysis, gave benzanilide and benzenesulphonic acid; thus:

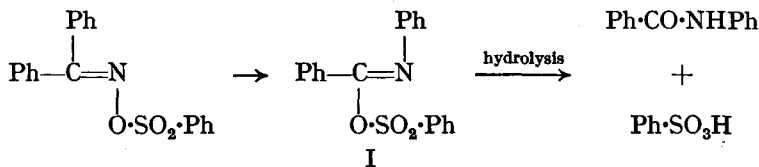

Kuhara assigned structure I to this intermediate on the fact that its absorption spectrum was almost identical with that of the compound prepared by reaction between *N*-phenylbenzimidoyl chloride and silver benzenesulphonate:

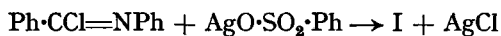

Kuhara (1926) also showed that the rate of rearrangement of the benzophenone oxime ester is faster the stronger the acid used to form the ester; the order obtained was:

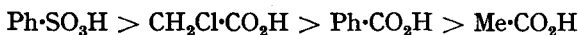

Chapman (1934) showed that the rate of rearrangement of benzophenone oxime picryl ester is faster in polar than in non-polar solvents. Thus the work of Kuhara and Chapman is strong evidence that the rate-determining step in the rearrangement is the ionisation of the intermediate.

Now let us consider the migration of the R or Ar group. This could be either intermolecular or intramolecular, but Kenyon *et al.* have shown it to be the latter; *e.g.*, in 1946, Kenyon *et al.* showed that when (+)- $\alpha$ -phenylethyl methyl ketoxime is treated with sulphuric acid the product, *N*- $\alpha$ -phenylethylacetamide, is almost 100 per cent. optically pure. Thus the migrating group never separates during the rearrangement, since if it did a racemised product would have been obtained. Furthermore, this retention of optical activity might be cited as evidence for the formation of a bridged-ion during the migration, since in such an ion the migrating group is not free and the "new partial" bond is formed on the *same* side as the bond which is breaking (see below).

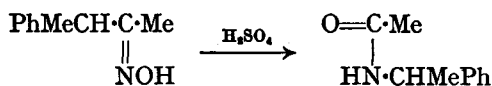

Another problem that arises here is: Does the anion separate completely during the ionisation or does it also migrate intramolecularly? The work of Kuhara and Chapman strongly suggests complete separation, and this is supported by the work of Brodskii *et al.* (1941), who found that when benzophenone oxime was treated with phosphorus pentachloride and then with water enriched with the isotope  $^{18}\text{O}$ , the benzanilide obtained contained some of this isotope. Thus the oxygen atom of the oxime group

must have been completely removed in the ionisation stage (see below). The following mechanism is in agreement with all of the above facts (Y is  $\text{PCl}_4$ ,  $\text{MeCO}$ , etc.); the lower set of equations is the alternative route *via*

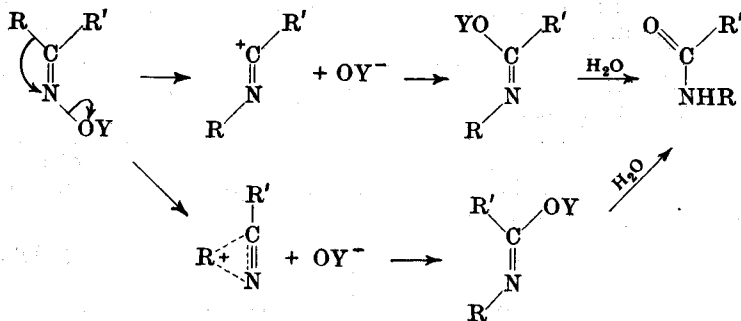

a bridged-ion. It might also be noted that when acid is used as the rearranging reagent,  $\text{OY}$  is probably  $\text{OH}_2^+$ . Support for this mechanism is the evidence obtained for the intermediate formation of the imidoyl ester ( $\text{RN}=\text{CR}\cdot\text{OY}$ ); compound II was obtained by Heard *et al.* (1959), who examined the rearrangement of a 17-keto-16-oxime (a steroid; Ch. XI):

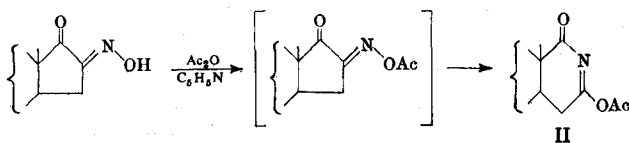

It has been shown that when the migrating group is aryl, the rate of the rearrangement is accelerated when there is an electron-releasing group, *e.g.*,  $\text{Me}$ , in the *p*-position. This may be cited as evidence to support the formation of a bridged-ion (at least for migrating aryl groups).

On the basis of the above mechanism, we can now explain Brodskii's results as follows:

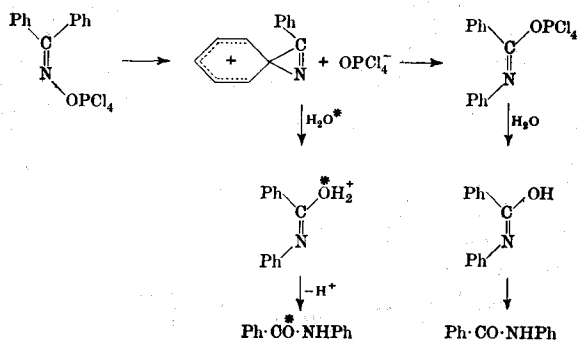

Stephen *et al.* (1956) have shown that *one* molecule of phosphorus pentachloride, phosphoryl chloride, thionyl chloride, or benzenesulphonyl chloride rearranges *two* molecules of the ketoxime to yield the corresponding amide and imidoyl chloride in approximately equimolecular amounts, *e.g.*,

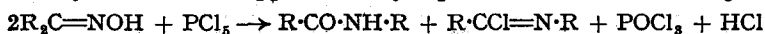

It has also been shown that hydrogen chloride is essential during the rearrangement, but that it does not itself cause the rearrangement of the



oxime. On the basis of these results, Stephen *et al.* have proposed the following mechanism for the Beckmann rearrangement of ketoximes. The reagent first produces some acid amide and imidoxy chloride, and the latter then dehydrates unchanged ketoxime to the anhydride which then reacts as shown:

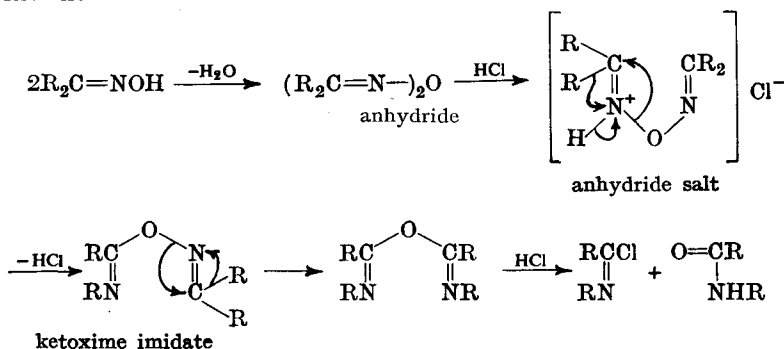

It is also suggested that other reagents which effect the Beckmann rearrangement may function as dehydrating agents for the formation of the ketoxime anhydride.

When a *trace* of the reagent is used, a large yield of amide is obtained. The mechanism is believed to be the same as that given above, provided that in the initial stage there is sufficient to form a trace of the ketoxime anhydride in the presence of hydrogen chloride. Rearrangement of the anhydride will now take place as above with the formation of the imidoxy chloride which can then dehydrate ketoxime to anhydride, itself being converted into the amide:



Thus the yield of amide increases at the expense of the imidoxy chloride.

It can be seen from the foregoing account that two mechanisms appear possible for the Beckmann rearrangement. Both are intramolecular, but now an intermolecular mechanism has also been proposed by Hill *et al.* (1962) who have reported an example in which the migrating group had the *inverted* configuration in the amide. These authors examined the rearrangement of 9-acetyl-*cis*-decalin oxime and have suggested the following mechanism:

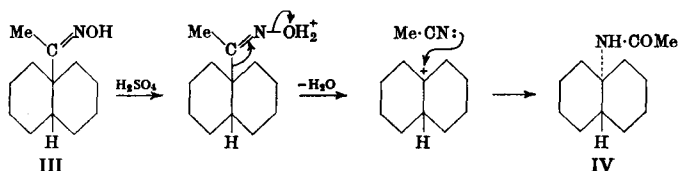

The authors identified methyl cyanide as a product of the reaction of III with phosphorus pentachloride, and also showed that methyl cyanide and *cis*- $\beta$ -decalol in sulphuric acid gave IV.

**§2i. Stereoisomerism of some other trivalent nitrogen compounds containing a double bond.** There are several other types of compounds besides the oximes in which the nitrogen atom is linked by a double bond. The other atom joined by this double bond may be a carbon atom (as in the oximes), or another nitrogen atom, and in both cases stereoisomerism is possible; *e.g.*, Krause (1890) obtained two isomeric forms of the phenylhydrazone of *o*-nitrophenylglyoxylic acid, I, and Hopper (1925) isolated two

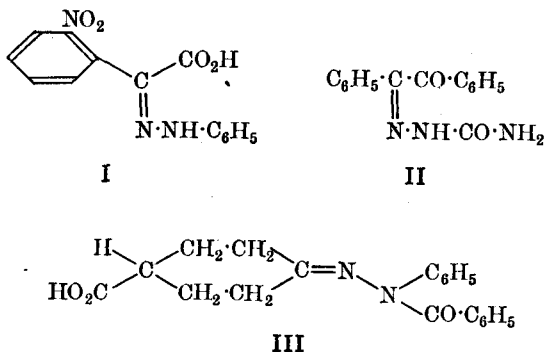

isomers of the monosemicarbazone of benzil, II. Mills and Bain (1914) resolved III; this is resolvable because of the non-planar configuration of the three nitrogen valencies (*cf.* the oximes, §2d). Karabatsos *et al.* (1962) have examined the NMR spectra of a number of ketone dinitrophenylhydrazones and semicarbazones, and have distinguished between the *syn*- and *anti*-forms, and have also calculated the amounts of each in solution. Phillips (1958) had already examined aldoximes by means of their NMR spectra.

Many cases of geometrical isomerism are known in which the two forms are due to the presence of a nitrogen-nitrogen double bond. Examples of this type which have been most extensively studied are the diazoates, IV, the diazosalphonates, V, and the diazocyanides, VI (see Vol. I, Ch. XXIV, for an account of these compounds).

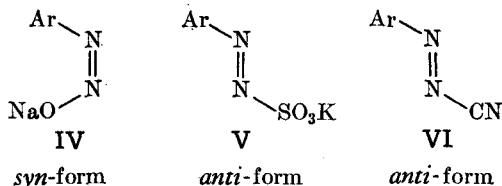

Azobenzene is also an example of this type, and according to Hartley (1938), "ordinary" azobenzene is the *anti*-form.

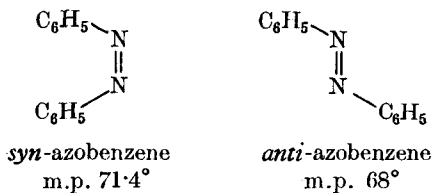

Azoxybenzene (in which one nitrogen atom is tricovalent and the other quadricovalent) also exists in two geometrical isomeric forms, the *anti*-isomer being "ordinary" azoxybenzene.

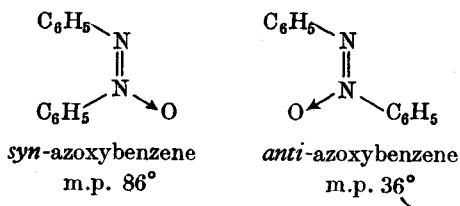

Recently, Le Fèvre *et al.* (1951) have measured the dipole moments and the ultraviolet absorption spectra of a number of triazens, and have concluded that these compounds exist in the *anti*-configuration about the nitrogen-nitrogen double bond, *i.e.*, the configuration is:

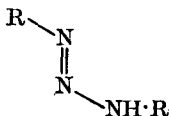

These authors also believe that this *anti*-form is converted into an equilibrium mixture of the *anti*- and *syn*-forms when exposed to sunlight.

Harley-Mason *et al.* (1961) have offered evidence to show that they have isolated the three theoretically possible geometrical isomers of *o*-nitroacetophenone azine (Ar = *o*-NO<sub>2</sub>C<sub>6</sub>H<sub>4</sub>):

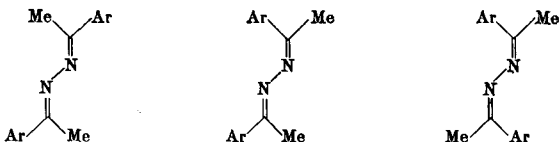

Their evidence was based on infra-red, ultraviolet and NMR spectra. This compound appears to be the first example of the isolation and characterisation of all three possible geometrical isomers of an azine.

### §3. STEREOCHEMISTRY OF PHOSPHORUS COMPOUNDS

Nitrogen, as we have seen, can exhibit covalencies of 3 and 4; phosphorus (and arsenic), however, can exhibit covalencies of 3, 4, 5 and 6, and consequently gives rise to more possible configurations than nitrogen. In tricovalent compounds the valency disposition is tetrahedral ( $sp^3$ ), one orbital being occupied by a lone-pair; and in quinquivalent compounds the valency disposition is trigonal bipyramidal ( $sp^3d$ ). In quadricovalent unielectrovalent compounds one electron is transferred from the phosphorus or arsenic atom to the anion and the valency disposition is tetrahedral ( $sp^3$ ) (see also §4b). When there are double bonds present, one is a  $\sigma$ - and the other is a  $\pi$ -bond; thus, in POCl<sub>3</sub>, the shape is tetrahedral (see also §1).

**§3a. Tercovalent phosphorus compounds.** Since the electronic configuration of phosphorus is  $(1s^2)(2s^2)(2p^6)(3s^2)(3p^3)$ , it might be expected that suitable tricovalent compounds, R<sub>3</sub>P, could be resolved, since the configuration would be a trigonal pyramid (*cf.* §2c). No tertiary phosphines, however, have yet been resolved, and the reason for this appears to be the same as for tertiary amines, *viz.*, that the phosphorus atom is in a state of oscillation. Calculation has shown that the frequency of this oscillation in phosphine is  $5 \times 10^6$ ; this is slower than that of nitrogen ( $2.3 \times 10^{10}$ ), and if it could be brought to zero, then tertiary phosphines would be resolvable. Increasing the weight of the groups slows down the oscillation in phosphorus compounds, *e.g.*, replacement of the three hydrogen atoms by deuterium atoms changes the frequency to  $6 \times 10^3$ . It seems possible, therefore, that very large groups might produce phosphines which would be resolvable; and if not zero in these compounds, the oscillation certainly can be expected to be zero in ring compounds (*cf.* nitrogen, §2c). Thus, if chemical difficulties can be overcome, tricovalent phosphorus compounds would be resolvable (see also §4c.)

§3b. **Quadricovalent and quinevalent phosphorus compounds.** The earliest phosphorus compounds to be resolved were the phosphine oxides, *e.g.*, Meisenheimer *et al.* (1911) resolved ethylmethylphenylphosphine

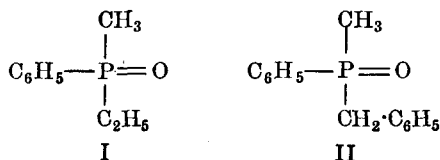

oxide, I, and benzylmethylphenylphosphine oxide, II. Recent measurements of the P—O (and As—O) bond length indicate that this bond is a double bond.

Some phosphine oxides that have been resolved recently are:

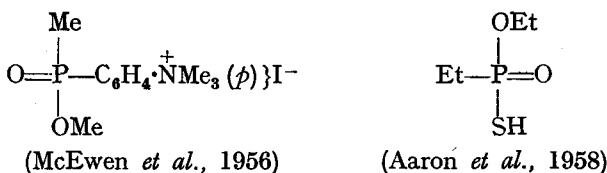

Kipping (1911) obtained two optically active forms of the *N*-(-)-menthyl derivative of 2-naphthylphenylphosphoramidic acid, III, and Davies and Mann (1944) resolved *n*-butylphenyl-*p*-carboxymethoxyphenylphosphine sulphide, IV.

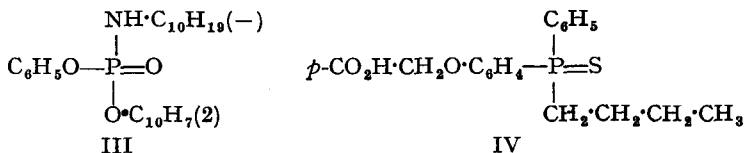

Michalski *et al.* (1959) have prepared the phosphorus sulphenyl chloride, (EtO)EtP(=O)·SCl, in its (+)- and (-)-forms, and Green *et al.* (1961) have partially resolved phenylethylphosphinothiolic acid, PhEtP(=O)·SH.

Another interesting phosphorus compound from the point of view of optical isomerism is ethyl triphenylmethylpyrophosphonate, V. If the two phosphorus atoms are asymmetric, then V contains two similar asymmetric carbon atoms, and so its structure corresponds to the molecule *Cabd·Cabd*.

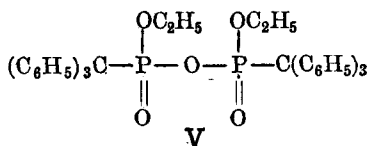

Thus there will be one racemic modification (composed of the pair of enantiomorphs) and one *meso*-form (*cf.* §7d. II). Hatt (1933) obtained two forms of compound V; both were inactive and so correspond to the racemic modification and the *meso*-form, but it was not possible to tell which was which.

Many attempts have been made to resolve quaternary phosphonium compounds, but until recently, all these attempts failed. This failure is attributed to the occurrence in solution of a "dissociation-equilibrium", which causes very rapid racemisation (see §4a).

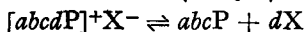

The earlier attempts to resolve phosphonium compounds were always carried

out on compounds containing at least one alkyl group; consequently dissociation in solution could occur, thereby resulting in racemisation. Holliman and Mann (1947) overcame this difficulty by preparing a much more stable type of phosphonium compound; these workers prepared a salt in which the phosphorus atom was in a ring, *viz.*, 2-phenyl-2-*p*-hydroxyphenyl-1:2:3:4-tetrahydro-*is*ospholinium bromide, VI, and resolved it.

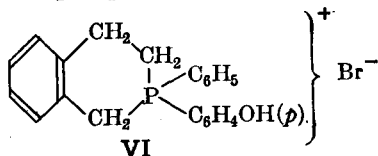

The resolution of 3-covalent compounds of phosphorus does not *prove* that the phosphorus atom has a tetrahedral configuration; it only proves that the phosphorus atom cannot be in the same plane as the other four groups

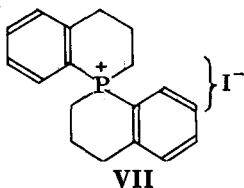

attached to it. Mann *et al.* (1955), however, have now synthesised P-spiro-bis-1:2:3:4-tetrahydrophospholinium iodide (VII) and resolved it into (+)- and (-)-forms which have high optical stability. The phosphorus atom is not asymmetric in this compound; it is the *tetrahedral* disposition of the four valencies which produces the dissymmetric cation (*cf.* nitrogen, §2a; see also §4b).

Campbell *et al.* (1960) have prepared a series of azaphosphaphenanthrene (IX; *e.g.*, R = H, R' = NMe<sub>2</sub>), but could not resolve them. When the

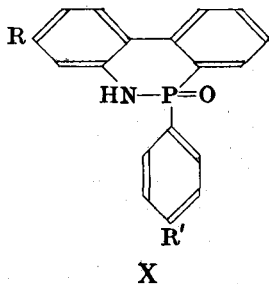
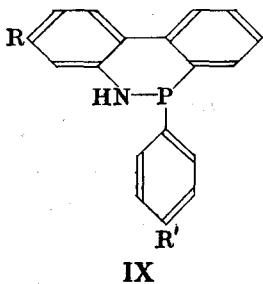

phosphine IX was oxidised with hydrogen peroxide, the phosphine oxide obtained, X, was resolved. Reduction of the (+)-oxide with lithium aluminium hydride gave the (-)-phosphine IX, and in the same way the reduction of the (-)-oxide gave the (+)-phosphine IX. It is not certain whether the optical activity in IX is due to an asymmetric trivalent phosphorus atom or to a rigid puckering of the molecular framework.

#### §4. STEREOCHEMISTRY OF ARSENIC COMPOUNDS

Arsenic, like phosphorus, can exhibit covalencies of 3, 4, 5 and 6; consequently these two elements show a great similarity to each other, and differ from nitrogen which has a maximum covalency of 4.

§4a. **Quadricovalent and quinquevalent arsenic compounds.** The first resolution of an arsonium compound was carried out by Burrows and Turner (1921). These workers obtained a solution of benzylmethyl-1-

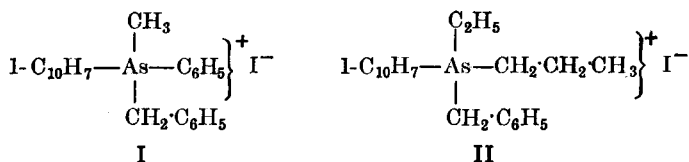

naphthylphenylarsonium iodide, I, that had a rotation of  $+12^\circ$ , but racemised rapidly (in solution). Similarly, Kamai (1933) isolated the (+)-form of benzylethyl-1-naphthyl-*n*-propylarsonium iodide, II, which also racemised rapidly in solution. This rapid racemisation is believed to be due to a "dissociation-equilibrium" in solution. This explanation was suggested by Pope and Harvey (1901) to account for the racemisation of certain ammonium salts, but definite evidence for this theory was provided by Burrows and Turner (1921) in their work on arsonium salts. If this dissociation-equilibrium occurs, then in solution there will be:

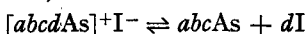

Burrows and Turner showed that when dimethylphenylarsine is treated with ethyl iodide, the expected ethyldimethylphenylarsonium iodide is

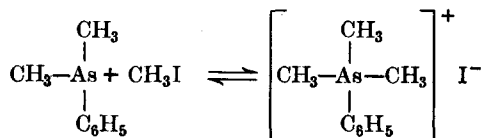
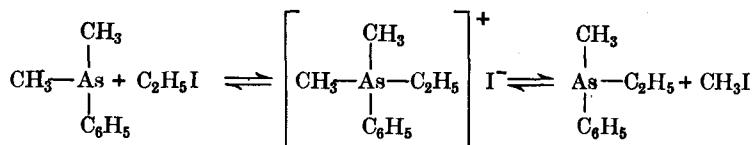

obtained, but at the same time a considerable amount of trimethylphenylarsonium iodide is also formed. These results are readily explained by the dissociation-equilibrium theory.

Since all the arsonium compounds investigated contained at least one alkyl group, Holliman and Mann (1943) prepared an arsonium compound with the arsenic atom in a ring, in the hope of stabilising the compound (*cf.* phosphorus, §3b). These authors prepared 2-*p*-chlorophenacyl-2-phenyl-1:2:3:4-tetrahydro-*iso*arsinolinium bromide, III, resolved it, and found that it did not racemise in solution at room temperature.

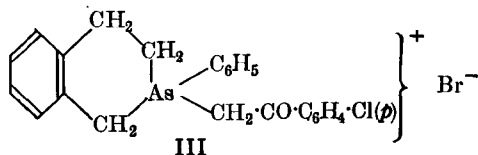

Although phosphine oxides of the type  $abc\text{PO}$  have been resolved (§3b), similar arsine oxides have not; the reason for this is obscure. On the other hand, arsine sulphides have been resolved, *e.g.*, Mills and Raper (1925) resolved *p*-carboxyphenylmethylethylarsine sulphide, IV.

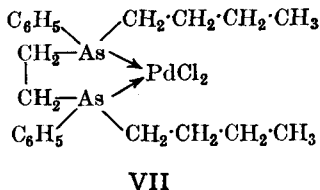
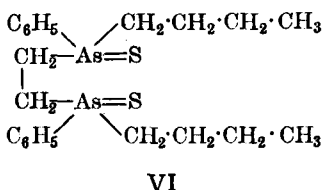
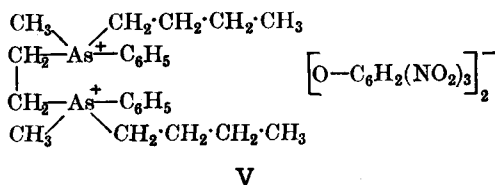
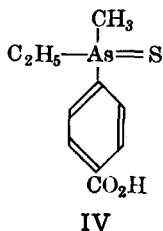

Chatt and Mann (1939) prepared ethylene-1 : 2-bis(*n*-butylmethylphenyl-*arsonium*) picrate, V, ethylene-1 : 2-bis(*n*-butylphenylarsine sulphide), VI, and ethylene-1 : 2-bis(*n*-butylphenylarsine)-dichloropalladium, VII, and obtained each compound in two forms. Each of these compounds is of the type *Cabd·Cabd*, and hence each should exist in one racemic modification and one *meso*-form (*cf.* §7d. II). As has already been stated, two forms of each were isolated; both were inactive, but the authors had no evidence for deciding which was which.

It has already been pointed out above that Holliman and Mann prepared

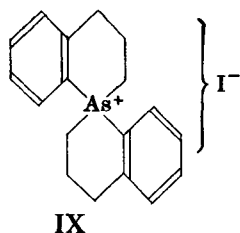
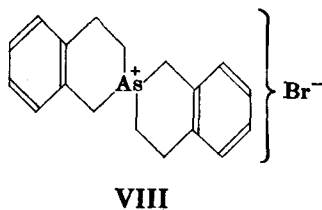

the optically stable arsonium compound III. These authors, in 1945, also resolved an arsonium compound of the spiran type, *viz.*, As-spiro-bis-1 : 2 : 3 : 4-tetrahydro-*iso*arsinolinium bromide, VIII. This does not contain an asymmetric arsenic atom; the optical activity is due to the asymmetry of the molecule (the two rings are perpendicular to each other), and this is evidence that the four valencies of arsenic are arranged tetrahedrally (see also §4b). Mann *et al.* (1960) have also resolved compound IX.

**§4b. Tervalent arsenic compounds.** The electronic configuration of arsenic is  $(1s^2)(2s^2)(2p^6)(3s^2)(3p^6)(3d^{10})(4s^2)(4p^3)$ . Thus the configuration of trivalent arsenic compounds will be a trigonal pyramid (*cf.* phosphorus,





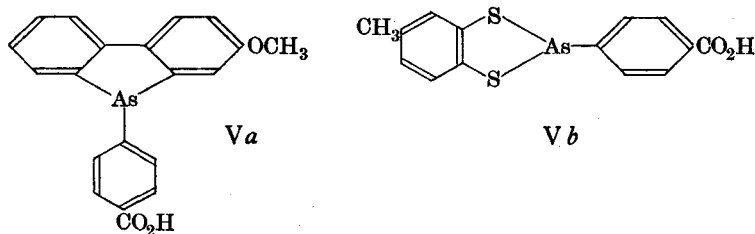

thioarsenites (Klement *et al.*, 1938). Furthermore, Cohen *et al.* (1931) have shown that in sodium hydroxide solution, alkyl thioarsenites exist in equilibrium with thiol and arsenoxide:

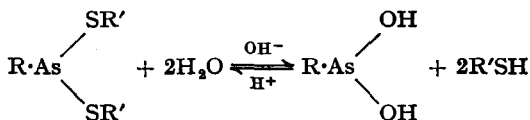

Chatt and Mann (1940) prepared 5 : 10-di-*p*-tolyl-5 : 10-dihydroarsanthren, and pointed out that if the valency angle of arsenic remains constant at its normal angle (of approximately 100°), then the structure will be folded, and consequently the three geometrical isomers, VI, VII and VIII, are apparently possible (T represents the *p*-tolyl group).

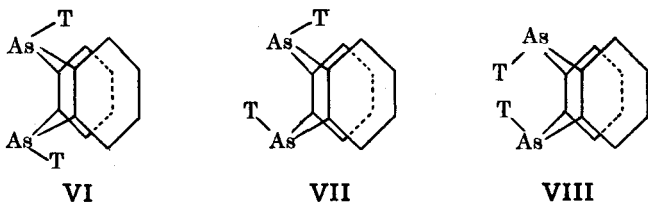

pointed out that evidence obtained from models constructed to scale showed that the two *p*-tolyl radicals (T) in VIII would almost be coincident, and hence this isomer cannot exist. These authors isolated two optically inactive forms, but were unable to say which was which. When each compound was treated with bromine, both gave the same tetrabromide which, on hydrolysis, gave only one tetrahydroxide. The loss of isomerism in the tetrabromide (and in the tetrahydroxide) may be explained as follows. Bromination of VI and VII converts tricovalent arsenic into quinquivalent arsenic, and in the latter state the ring valency angles of the arsenic become 120°, and so the arsanthren nucleus is *now* planar. Thus both the

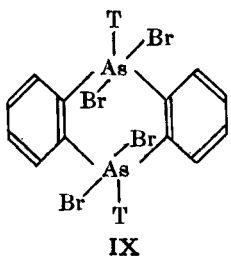

forms VI and VII would give the same tetrabromide, IX (the same is true for the tetrahydroxide); the tetrabromide should thus be planar, the configuration of each arsenic atom being trigonal bipyramidal in the 5-covalent state (Fig. 2).

Quinquevalent phosphorus and arsenic can make use of the  $3d$  or  $4d$  orbitals, respectively (*cf.* nitrogen, §2b). Thus nitrogen has a maximum covalency of 4, whereas that of phosphorus and arsenic is 5 or 6, *e.g.*, the covalency of 6 is exhibited by phosphorus in *solid* phosphorus pentachloride; X-ray diffraction shows this "molecule" (in the solid state) is  $\text{PCl}_4^+ \text{PCl}_6^-$ .

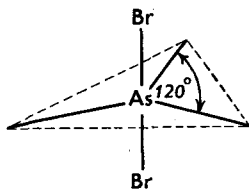
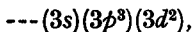

FIG. 6.2.

Phosphorus, which is  $(1s^2)(2s^2)(2p^6)(3s^2)(3p^3)$  in the ground state, may become  $(1s^2)(2s^2)(2p^6)(3s)(3p^3)(3d)$  in its "valence state", since the  $3s$  and  $3d$  orbitals have energy levels which are close together. Kimball (1940) showed, by calculation, that this arrangement, *i.e.*,  $sp^3d$ , could give rise to the stable trigonal bipyramidal configuration. This consists of three equivalent coplanar orbitals pointing towards the corners of an equilateral triangle, and two orbitals perpendicular to this plane (see Fig. 2). Electron diffraction studies of the vapours of phosphorus pentachloride and pentafluoride indicate the trigonal bipyramidal configuration in these molecules. The phosphonium ion might possibly be formed from this trigonal bipyramid by the transference of one of the electrons, or by the transference of a  $3s$  electron and hybridisation of the  $(3s)(3p^3)$  orbitals; in either case the tetrahedral configuration of the phosphonium ion can be asymmetric, but only in the case of the hybridisation of the  $(3s)(3p^3)$  orbitals will the four bonds be equivalent. Since the properties of phosphonium compounds are in agreement with the equivalence of the four bonds, it therefore appears, on theoretical grounds, that the tetrahedral configuration with the phosphorus atom at the centre is the probable one.

From the experimental side, the preparation of optically active spiro-compounds of phosphorus (§3b) and of arsenic (§4a) proves the tetrahedral configuration of these atoms. Earlier work by Mann *et al.* (1936, 1937) has also definitely established this configuration. These authors prepared compounds of the type  $[\text{R}_3\text{As}-\text{CuI}]_4$  by combination of tertiary arsines or phosphines with cuprous iodide (or silver iodide); in these compounds the phosphorus or arsenic is 4-covalent, and X-ray analysis studies of the arsenic compound showed that the arsenic atom is at the centre of a tetrahedron. Since the corresponding phosphorus compounds are isomorphous, the configuration of the phosphorus is also tetrahedral.

In the *solid* state, phosphorus and arsenic compounds may contain a negatively charged phosphorus or arsenic atom, *e.g.*,  $\text{PCl}_4^+ \text{PCl}_6^-$  (see above). In this condition, the phosphorus acquires an electron to become



and the arsenic also acquires an electron to become  $\text{---}(4s)(4p^3)(4d^2)$ . In both cases the configuration is octahedral (six  $sp^3d^2$  bonds), *e.g.*, the following compound has been resolved (Rosenheim *et al.*, 1925).

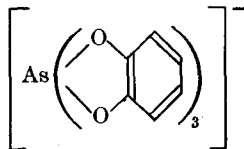

Harris *et al.* (1956) have shown that a negatively charged phosphorus atom can also exist in *solution*; these authors showed that triphenyl phosphite dibromide ionises in methyl cyanide solution as follows:

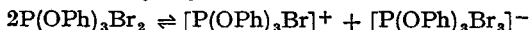

§4c. **Stereochemistry of antimony compounds.** Some optically active trivalent antimony compounds have been prepared, the phenoxstibine (I) and the stibiafluorene (II; Campbell, 1947, 1950). The asymmetry in I is probably due to the folding about the O—Sb axis (*cf.* phenoxarsines, §4b). Campbell *et al.* (1958) have also resolved the stibine (III).

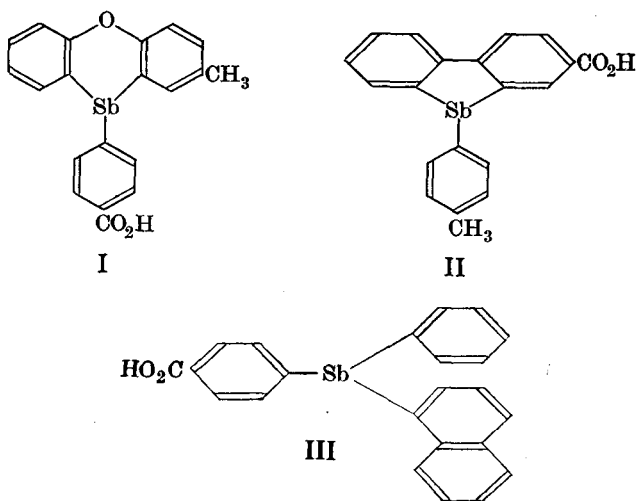

It is of interest to note, in this connection, that calculations by Weston (1954) have led him to the conclusion that trivalent antimony, arsenic and sulphur compounds should be stable to inversion at room temperature. On the other hand, similar compounds of phosphorus would be optically stable only at low temperatures, and those of nitrogen not at all.

## §5. STEREOCHEMISTRY OF SULPHUR COMPOUNDS

Various types of sulphur compounds have been obtained in optically active forms, and although the general picture of the configurations of these molecules is quite clear, the details of the nature of the bonds of the central sulphur atom are in a state of flux (see §5e).

§5a. **Sulphonium salts.** Pope and Peachey (1900) prepared carboxymethylethylmethylsulphonium bromide by the reaction between ethyl methyl sulphide and bromoacetic acid, and formulated the reaction as follows:

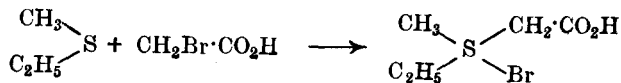

At this time (before the electronic theory of valency, 1916), sulphur was believed to be quadricovalent, and so Pope and Peachey accounted for the optical activity of this compound (see below) by assuming that the sulphur atom was at the centre of a tetrahedron, *i.e.*, the configuration was similar to carbon. According to the electronic theory of valency, however, sulphur

is tervalent unielectrovalent in sulphonium salts, and the valency disposition is ( $sp^3$ ), one orbital being occupied by a lone-pair of electrons (Fig. 3). This molecule is not superimposable on its mirror image, and hence can, at least theoretically, exist in two optically active forms. This bromide was treated with silver (+)-camphorsulphonate and the salt

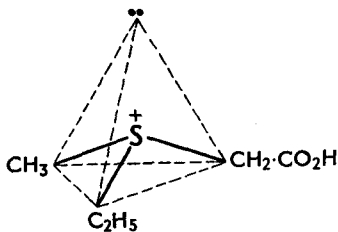
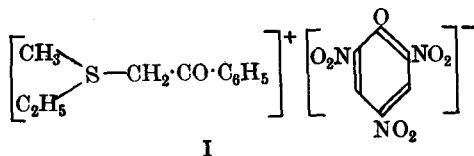

FIG. 6.3.

obtained was fractionally crystallised from a mixture of ethanol and ether. Pope and Peachey found that the (+)-sulphonium camphorsulphonate was the less soluble fraction, and had an  $M_D$  of  $+68^\circ$ . Since the rotation of the (+)-camphorsulphonate ion is about  $+52^\circ$ , this leaves  $+16^\circ$  as the contribution of the sulphonium ion to the total rotation (see §12. I). Although this does not prove conclusively that the sulphur compound is optically active, it is certainly strong evidence in its favour. Final proof was obtained by replacement of the camphorsulphonate ion by the platini-chloride ion to give  $[\text{CH}_3(\text{C}_2\text{H}_5)\cdot\text{S}\cdot\text{CH}_2\cdot\text{CO}_2\text{H}]_2^+\text{PtCl}_6^-$ ; this compound had an  $[\alpha]_D$  of  $+4.5^\circ$  in water. In a similar way, Smiles (1900) prepared ethyl-methylphenacylsulphonium picrate, I, in two optically active forms, one



I

with an  $[\alpha]_D$  of  $+8.1^\circ$  and the other  $-9.2^\circ$ . A more recent example of an optically active sulphonium salt is one with the sulphur atom in a ring; this compound, II, was obtained as the optically active ion with the picrate Mann and Holliman, 1946).

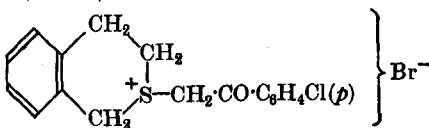

II

**§5b. Sulphinic esters.** Phillips (1925) partially resolved sulphinic esters,  $\text{R}\cdot\text{SO}_2\text{R}'$ , by means of the kinetic method of resolution (§10 vii. II). Two molecules of ethyl *p*-toluenesulphinate were heated with one molecule of (-)-menthyl alcohol or (-)-*sec*-octyl alcohol, *i.e.*, the sulphinate was subjected to alcoholysis. Now, if the sulphinate is a racemic modification, then the (+)- and (-)- forms will react at *different* rates with the optically active alcohol (see §§2, 7b. II). Phillips actually found that the (+)-ester reacted faster than the (-)-ester. If we represent the ester by E, the alcohol by A, and unchanged ester by  $\text{E}_r$ , then the following equation symbolises the alcoholysis:

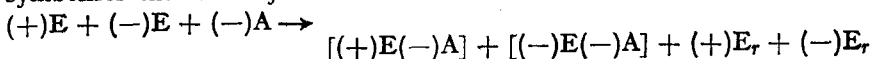

Since  $[(+)\text{E}(-)\text{A}]$  is greater than  $[(-)\text{E}(-)\text{A}]$ , it therefore follows that  $(+)\text{E}_r$  is less than  $(-)\text{E}_r$ ; thus a partial resolution has occurred. The unchanged ester, having a lower boiling point than the new ester, distilled off first; this contained more of the  $(-)$ -form. The residual ester (the higher boiling fraction) was then heated with a large excess of ethanol; alcoholysis again occurred, this time the  $(-)$ -alcohol (menthol or octyl) being displaced to regenerate the original ethyl *p*-toluenesulphinate. This resulted in a fraction containing more of the  $(+)\text{-form}$ .

To account for the optical activity of these sulphinates, the older formula I, with quadricovalent sulphur linked to the oxygen atom by a double bond, was replaced by formula II, in which the sulphur atom is at the centre of the tetrahedron, but one corner is occupied by a lone-pair of electrons

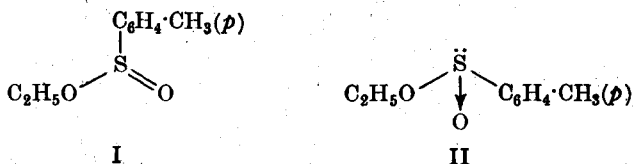

(*cf.* Fig. 3). In I, the sulphur atom was considered to be at the centre of a tetrahedron, and the molecule is *flat*, and consequently is superimposable on its mirror image. Molecule II, however, is asymmetric, and so is optically active. Recent evidence, however, is now in favour of structure I, and the molecule is *not* flat (see §5e). The formulæ of sulfoxides, etc., will therefore be written with double bonds.

**§5c. Sulphoxides.** Sulfoxides of the type  $\text{R}\cdot\text{SO}\cdot\text{R}'$  have also been resolved; sulphoxides I and II were resolved by Phillips *et al.* (1926), and Karrer *et al.* (1951) obtained III in the  $(-)$ -form and the racemic modification.

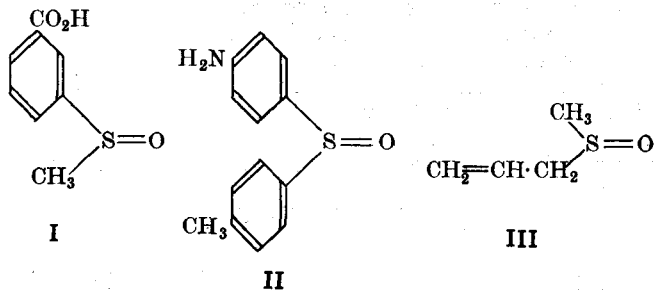

Bell and Bennett (1927) investigated disulphoxides of the type

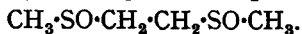

This molecule contains two similar asymmetric carbon atoms and so is of the type *Cabd·Cabd*. Thus it should exist in one racemic modification and one *meso*-form. Bell and Bennett failed to resolve this compound, but succeeded in resolving the following disulphoxide.

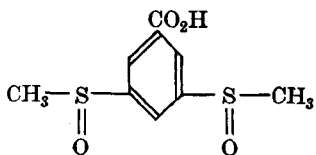

If the former disulphoxide (the dioxide of a 1:4-dithian) is converted

into the corresponding ring compound (*i.e.*, into a cyclic 1 : 4-dithian), then two geometrical isomers are possible, neither of which is resolvable; these two forms have been isolated by Bell and Bennett (1927, 1929). Shearer (1959) has examined the *trans*-form by X-ray analysis and showed that the ring is in the chair form with the S=O in *trans* and axial positions.

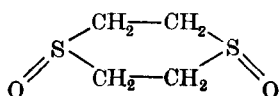
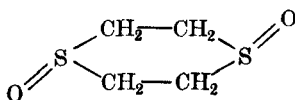
*cis**trans*

Thianthren dioxide, IV, also exists in two geometrical isomeric forms,  $\alpha$ , m.p. 284°,  $\mu = 1.7$  D; and  $\beta$ , m.p. 249°,  $\mu = 4.2$  D (Bergmann *et al.*, 1932). On the basis of these dipole moments, Bergmann assigned the *trans*-configuration to the  $\alpha$ -form and the *cis*-configuration to the  $\beta$ -form. Hosoya *et al.* (1957) have examined the  $\alpha$ -form by X-ray analysis and showed it was boat-shaped (only this part of the molecule is shown in the diagrams), with the molecule folded along the S—S axis (*cf.* the dithian dioxides above). These authors also showed that this  $\alpha$ -form has the *anti-cis*-configuration

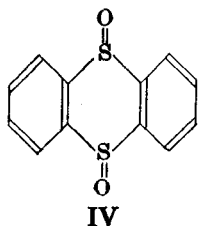

IV

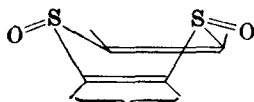
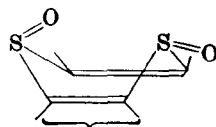
 $\alpha$ -form $\beta$ -form

of the two S=O bonds. The  $\beta$ -form is therefore assumed to be a *trans*-form. Thus the configurations are the *reverse* of those given by Bergmann. When either of these disulphoxides is oxidised to the disulphone, both give the same compound (Hosoya, 1958).

It is of interest to note, in connection with optically active sulphoxides, that Schmid and Karrer (1948) have isolated *sulphoraphen* from its glycoside which occurs in radish seed. These authors showed that sulphoraphen is a laevorotatory oil which owes its optical activity to the presence of a sulphoxide group.

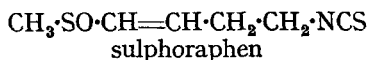

**§5d. Sulphilimines.** Chloramine T reacts with alkyl sulphides to form sulphilimines, *e.g.*,

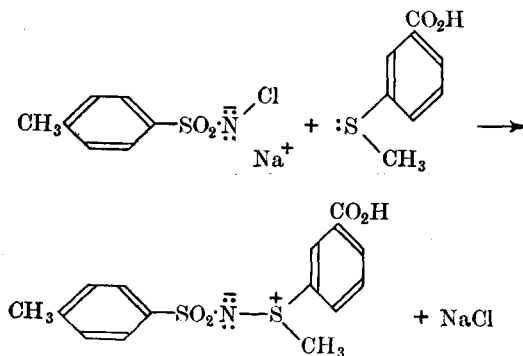

The electronic structure of this molecule appears to be uncertain; one possibility has been given above, and in this one the sulphur atom is asymmetric (it is of the type that occurs in the sulphonium salts). An alternative electronic structure is:

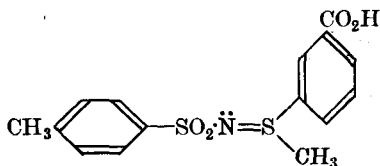

In this structure, the sulphur atom can still be asymmetric (see §5e). This sulphilimine has been resolved by Kenyon *et al.* (1927).

It seems likely that sulphilimines are resonance hybrids of the above two contributing structures.

**§5e. The valency disposition of the sulphur atom.** The electronic configuration of sulphur is  $(1s^2)(2s^2)(2p^6)(3s^2)(3p^4)$ . As we have seen, the older formulæ (IIa) and (IIIa) for sulphoxides and sulphinic esters were replaced by Phillips by (II) and (III) respectively. However, in the light of more recent work, these compounds are now believed to contain double bonds, *e.g.*, the length of the S—O bond in sulphoxides and sulphones is shorter than the single S—O bond.

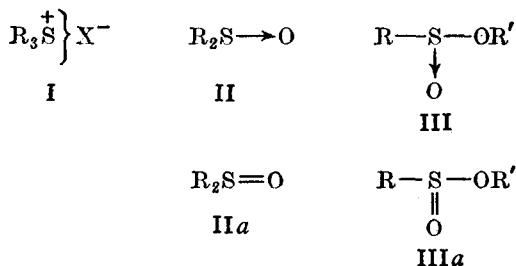

It has already been pointed out that these multiple bond formulæ were rejected on the grounds that such molecules, on the assumption that the sulphur atom was quadrivalent and at the centre of a tetrahedron, would be flat and hence not optically active. If we consider the shapes of optically active sulphur compounds from the point of view of the ideas discussed in §1, then in the formulæ (I), (IIa) and (IIIa), the sulphur atom has one lone-pair of electrons (these are not shown in the formulæ), three  $\sigma$ - and one  $\pi$ -bond. Thus the bond spatial arrangement will be tetrahedral, the lone-pair occupying one of these orbitals. Consequently each molecule will be a trigonal pyramid and is not superimposable on its mirror image when all three groups are different. It might be noted here that the double bonds are composed of one  $\sigma$ - and one  $d_{\pi}-p_{\pi}$  bond. In these compounds the  $d$  orbitals are produced by promotion of one  $3s$  and one  $3p$  electron to  $3d$ ; this is possible because of the small energy differences between the orbitals concerned. In sulphonium salts, since only three single bonds and one lone-pair are present, the hybridisation is  $sp^3$  (tetrahedral); one electron has been transferred to the halogen atom, thereby producing the positively charged sulphonium ion.

**§6. Stereochemistry of silicon compounds.** Kipping (1907) prepared benzylethylpropylsiliclyl oxide, I, and isolated one form of it. If the silicon atom has a tetrahedral configuration, this molecule is of the type *Cabd·Cabd*,

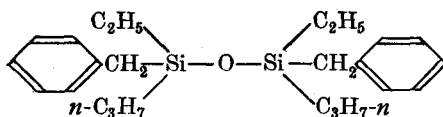

I

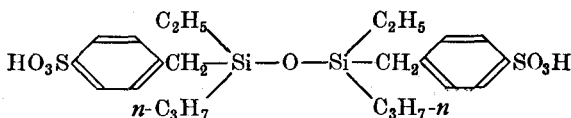

II

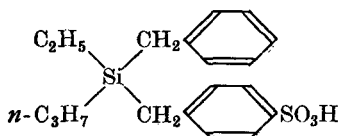

III

*i.e.*, it should exist in (+)-, (-)- and *meso*-forms. When I was sulphonated to give II, the latter compound was resolved. Challenger and Kipping (1910) also resolved the silane III, and Eaborn *et al.* (1958) have resolved the silane IV.

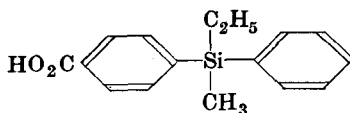

IV

§7. **Stereochemistry of tin compounds.** Pope and Peachey (1900) obtained ethylmethyl-*n*-propylstannonium iodide in the dextrorotatory form; concentration of the mother liquor also gave this (+)-form. Thus we have an example of asymmetric transformation (§10 iv. II).

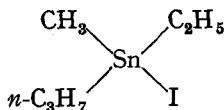

§8. **Stereochemistry of germanium compounds.** Schwarz and Lewinsohn (1931) obtained the (+)-form of ethylphenyl*iso*-propylgermanium bromide, but failed to get the (-)-form; this latter form appears to racemise in the mother liquor.

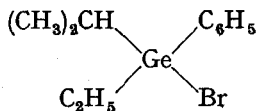

§9. **Stereochemistry of selenium compounds.** Pope *et al.* (1902) resolved carboxymethylmethylphenylselenonium bromide in the same way as the corresponding sulphonium salts (§5a); they obtained the active platinumchloride.

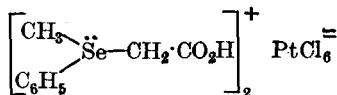



Mann *et al.* (1945) also resolved the following selenonium salt:

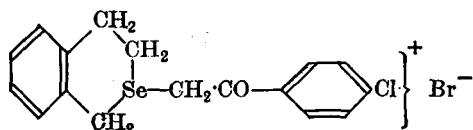

So far, attempts to resolve selenoxides have failed.

§10. Stereochemistry of tellurium compounds. Lowry *et al.* (1929) obtained the optically active forms of methylphenyl-*p*-tolyltelluronium iodide, I, and Mann *et al.* (1945) have resolved II.

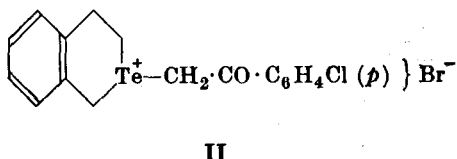
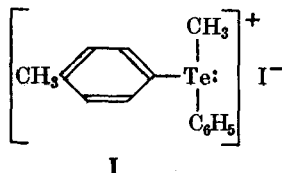

#### READING REFERENCES

- Gilman (Ed.), *Advanced Organic Chemistry*, Wiley (1943, 2nd ed.). Ch. 4, pp. 400-443.  
 Optical Isomerism of Elements other than Carbon.  
 Dickens and Linnett, Electron Correlation and Chemical Consequences, *Quart. Reviews (Chem. Soc.)*, 1957, **11**, 291.  
 Gillespie and Nyholm, Inorganic Stereochemistry, *Quart. Reviews (Chem. Soc.)*, 1957, **11**, 339.  
*Organic Reactions*, Wiley. Vol. 11 (1960). Ch. 1. The Beckmann Rearrangement.  
 Mann, *The Heterocyclic Derivatives of P, As, Sb, Bi, and Si*, Interscience Publishers (1950).  
 Campbell and Way, Synthesis and Stereochemistry of Heterocyclic Phosphorus Compounds, *J.C.S.*, 1960, 5034.  
 Abrahams, The Stereochemistry of Sub-group VIB of the Periodic Table, *Quart. Reviews (Chem. Soc.)*, 1956, **10**, 407.  
 McCasland and Proskow, Synthesis of an Image-Superposable Molecule which Contains no Plane or Centre of Symmetry, *J. Amer. Chem. Soc.*, 1956, **78**, 5646.  
 Klyne and de la Mare (Ed.), *Progress in Stereochemistry*, Butterworth. Vol. II (1958). Ch. 6. The Stereochemistry of the Group V Elements.

CHAPTER VII  
CARBOHYDRATES

This chapter is mainly concerned with the stereochemistry of the carbohydrates and the structures of the disaccharides and polysaccharides. It is assumed that the reader is familiar with the open-chain structures and general reactions of the monosaccharides (for an elementary account of these compounds, see Vol. I, Ch. XVIII).

**§1. DETERMINATION OF THE CONFIGURATION OF THE MONOSACCHARIDES**

**Aldotrioses.** There is only one aldotriose, and that is glyceraldehyde. As we have seen (§5. II), the enantiomorphs of this compound have been chosen as the *arbitrary* standards for the D- and L-series in sugar chemistry:

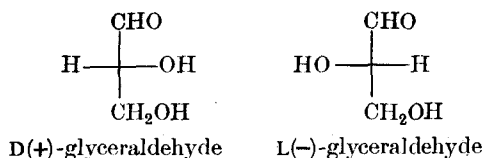

The conventional planar diagrams of the sugars are always drawn with the CHO (or CH<sub>2</sub>OH·CO) group at the top and the CH<sub>2</sub>OH group at the bottom; the following short-hand notation is also used:

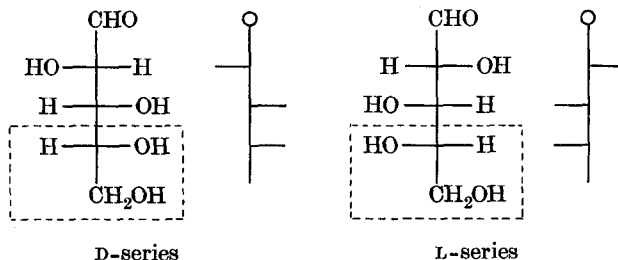

**Aldotetroses.** The structural formula of the aldotetroses is CH<sub>2</sub>OH·CHOH·CHOH·CHO.

Since this contains two unlike asymmetric carbon atoms, there are four

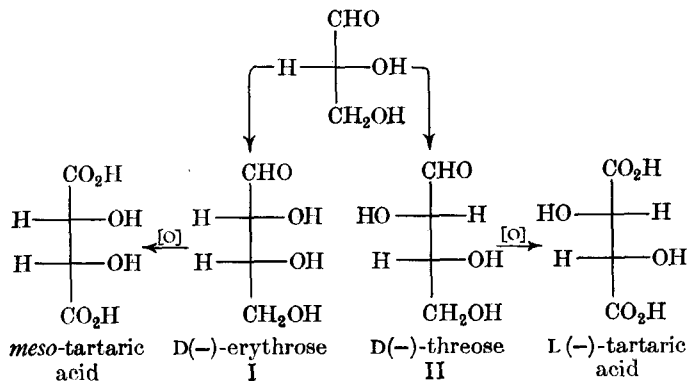

optically active forms (two pairs of enantiomorphs) possible theoretically. All four are known, and correspond to D- and L-threose and D- and L-erythrose. D(+)-Glyceraldehyde may be stepped up by the Kiliani reaction to give D(-)-erythrose and D(-)-threose. The question now is: Which is which? On oxidation, D-erythrose gives *mesotartaric*, and on reduction gives *mesoerythritol*. Therefore D-erythrose is I, and consequently II must be D-threose. The configuration of the latter is confirmed by the fact that on oxidation, D-threose gives L(-)-tartaric acid.

**Aldopentoses.** These have the structural formula



and since it contains three unlike asymmetric carbon atoms, there are eight optically active forms (four pairs of enantiomorphs). All are known, and correspond to the D- and L-forms of ribose, arabinose, xylose and lyxose. Their configurations may be ascertained by either of the following two methods.

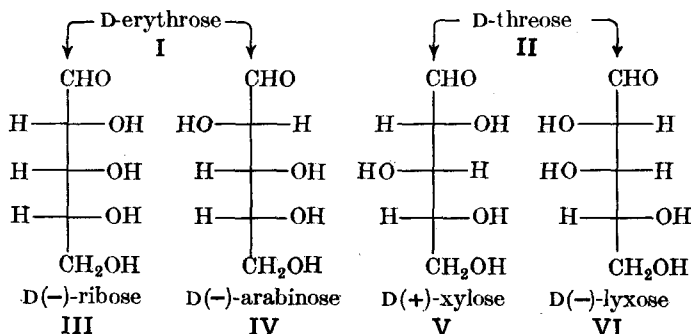

One method starts by stepping up the aldotetroses by the Kiliani reaction. Thus D-erythrose gives D(-)-ribose and D(-)-arabinose; similarly, D-threose gives D(+)-xylose and D(-)-lyxose. III and IV must be ribose and arabinose, but which is which? On oxidation with nitric acid, arabinose gives an optically active dicarboxylic acid (a trihydroxyglutaric acid), whereas ribose gives an optically inactive dicarboxylic acid. When the terminal groups, *i.e.*, CHO and CH<sub>2</sub>OH, of III are oxidised to carboxyl groups, the molecule produced (III<sub>a</sub>) possesses a plane of symmetry, and so is inactive. Oxidation of IV gives IV<sub>a</sub>, and since this molecule has no plane (or any other element) of symmetry, it is optically active. Thus III is D-ribose and IV is D-arabinose.

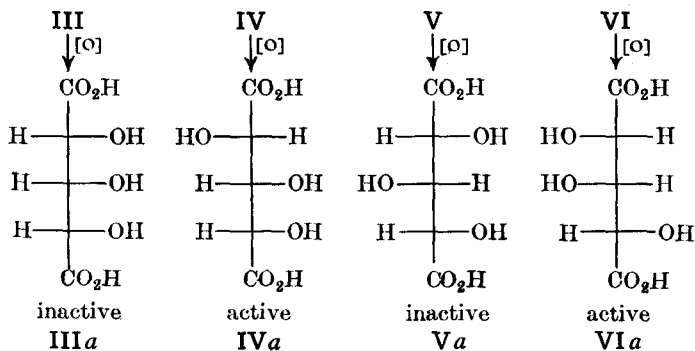

V and VI must be xylose and lyxose, but which is which? The former sugar, on oxidation, gives an optically inactive dicarboxylic acid, whereas

the latter gives an optically active dicarboxylic acid. Therefore V is D-xylose and VI is D-lyxose.

The following is the alternative method of elucidating the configurations of the aldopentoses; it is more in keeping with Fischer's solution to the problem. The structural formula of the aldopentoses can give rise to four pairs of enantiomorphs, the D-forms of which are as follows:

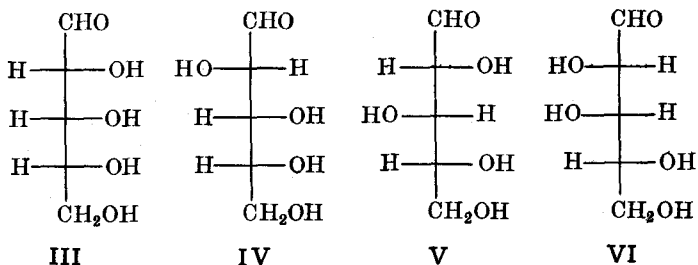

It should be noted that these four configurations have been obtained from first principles (see §7c. II); no recourse has been made to the configurations of the aldotetroses. Arabinose and lyxose, on oxidation with nitric acid, produce optically active dicarboxylic acids (trihydroxyglutaric acids). Therefore these two pentoses must be IV and VI, but we cannot say which is which. Xylose and ribose, on oxidation, produce optically inactive dicarboxylic acids (trihydroxyglutaric acids). Therefore these two pentoses must be III and V, and again we cannot say which is which. When each

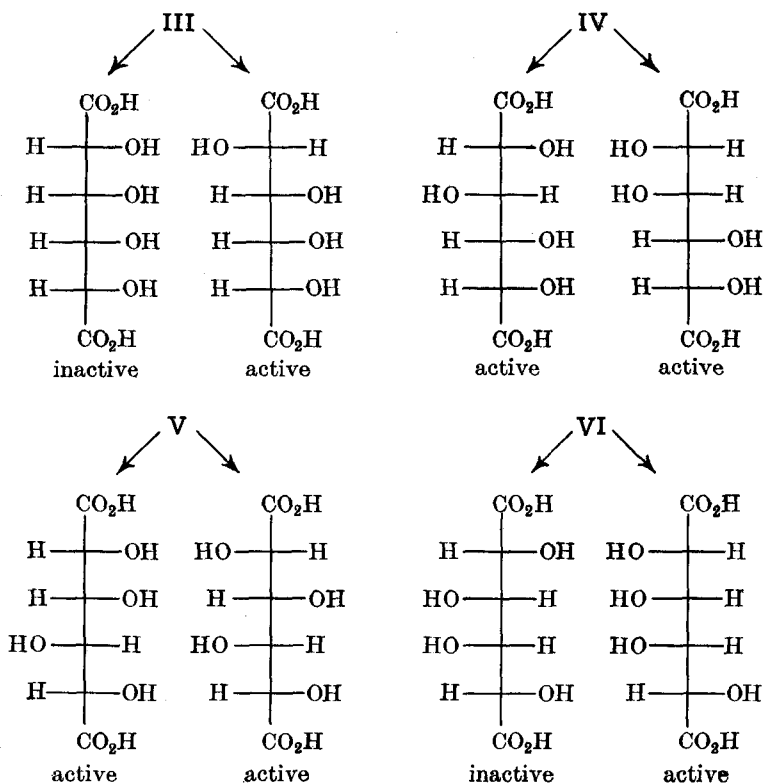

aldopentose is stepped up by one carbon atom (by means of the Kiliani reaction) and then oxidised to the dicarboxylic acid (the terminal groups are oxidised), it is found that arabinose and xylose each give *two* active dicarboxylic acids, whereas ribose and lyxose each give one active and one inactive (*meso*) dicarboxylic acid. The chart at foot of previous page shows the dicarboxylic acids obtained from the configurations III-VI.

It therefore follows that D-ribose is III, D-arabinose is IV, D-xylose is V and D-lyxose is VI. These configurations are confirmed by the facts that ribose and arabinose give the same osazone, and xylose and lyxose give the same osazone; the only difference between sugars giving the same osazone is the configuration of the second carbon atom, *i.e.*, III and IV are epimers, as are V and VI. It should also be noted that arabinose and lyxose produce the same trihydroxyglutaric acid on oxidation.

**Aldohexoses.** The structural formula of these compounds is

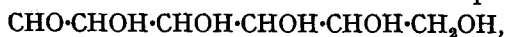

and since it contains four unlike asymmetric carbon atoms, there are sixteen optically active forms (eight pairs of enantiomorphs). All are known, and may be prepared by stepping up the aldopentoses: D-ribose gives D(+)-allose and D(+)-altrose; D-arabinose gives D(+)-glucose and D(+)-mannose; D-xylose gives D(-)-gulose and D(-)-idose; and D-lyxose gives D(+)-galactose and D(+)-talose.

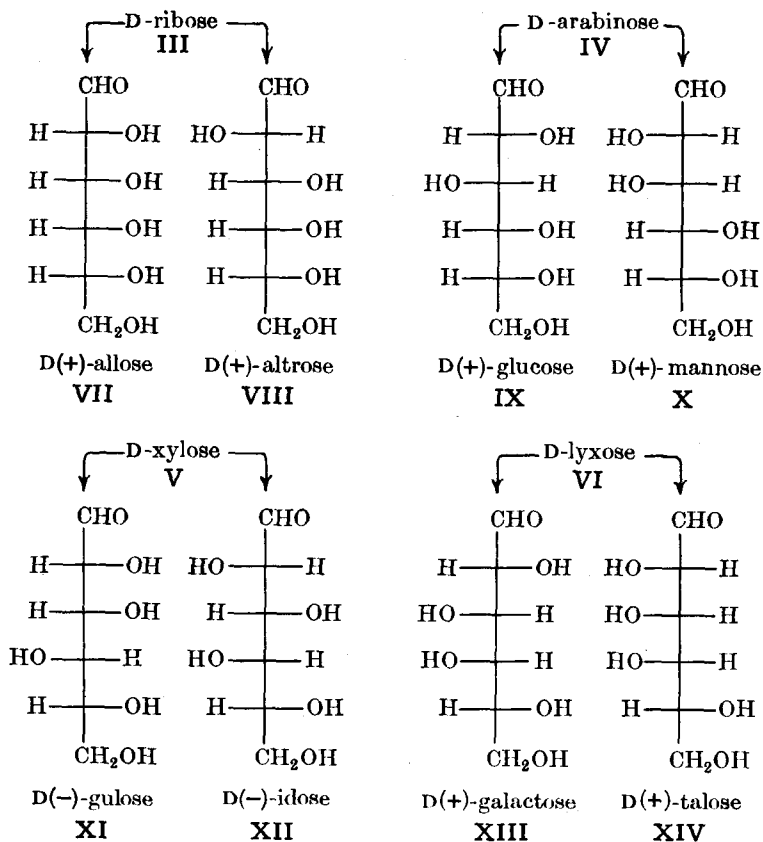

VII and VIII must be allose and altrose, but which is which? On oxidation with nitric acid, the former gives an optically inactive (allomucic) and

the latter an optically active (talmucic) dicarboxylic acid. Therefore allose is VII and altrose is VIII.

XIII and XIV must be galactose and talose, but which is which? On oxidation with nitric acid, the former gives an optically inactive (mucic) and the latter an optically active (talmucic) dicarboxylic acid. Therefore XIII is galactose and XIV is talose.

The elucidation of the configurations of the remaining four aldohexoses is not quite so simple, since, on oxidation with nitric acid, glucose and mannose *both* give optically active dicarboxylic acids, as also do gulose and idose; in all four configurations (IX, X, XI, XII), replacement of the two terminal groups (CHO and CH<sub>2</sub>OH) by carboxyl groups leads to dicarboxylic acids whose structures have no plane (or any other element) of symmetry. It has been found, however, that the dicarboxylic acid from glucose (saccharic acid) is the same as that obtained from gulose (actually the two saccharic acids obtained are enantiomorphous, D-glucose giving D-saccharic acid and D-gulose L-saccharic acid). Since saccharic acid, CO<sub>2</sub>H·(CHOH)<sub>4</sub>·CO<sub>2</sub>H, is produced by the oxidation of the terminal groups with the rest of the molecule unaffected, it therefore follows that the "rest of molecule" must be the same for both glucose and gulose. Inspection of formulæ IX, X, XI and XII shows that only IX and XI have the "rest of the molecule" the same; by interchanging the CHO and CH<sub>2</sub>OH groups of IX, the enantiomorph of XI, *i.e.*, L-gulose, is obtained. Therefore IX must be glucose (since we know that glucose is obtained from arabinose), and XI must be gulose. Consequently X is mannose and XII is idose.

**Ketohexoses.** All the ketohexoses that occur naturally have the ketonic group adjacent to a terminal CH<sub>2</sub>OH group, *i.e.*, the structural formula of all the natural ketohexoses is



Since this structure contains three dissimilar asymmetric carbon atoms,

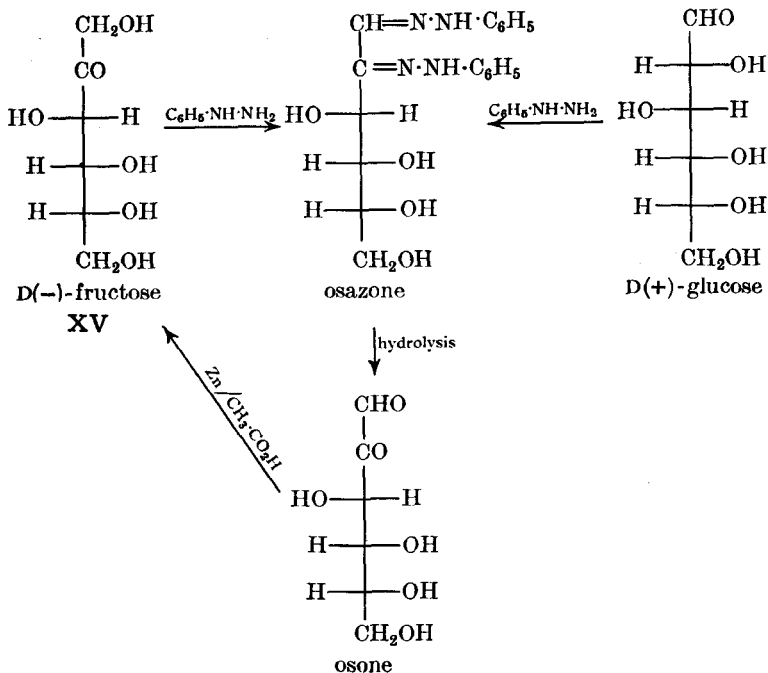

there are eight optically active forms (four pairs of enantiomorphs) possible theoretically; of these the following six are known: D(-)- and L(+)-fructose, D(+)- and L(-)-sorbitose, D(+)-tagatose and L(-)-psicose. Only D(-)-fructose, L(-)-sorbitose and D(+)-tagatose occur naturally.

**Fructose.** Natural fructose is levorotatory, and since D-glucose gives the *same* osazone as natural fructose, the latter must be D(-)-fructose. Furthermore, since osazone formation involves only the first two carbon atoms in a sugar, it therefore follows that the configuration of the rest of the molecule in glucose and fructose must be the same. Hence the configuration of D(-)-fructose is XV, and is confirmed by the fact that D(+)-glucose may be converted into D(-)-fructose *via* the osazone (see chart at foot of previous page).

The configurations of the other ketohexoses are:

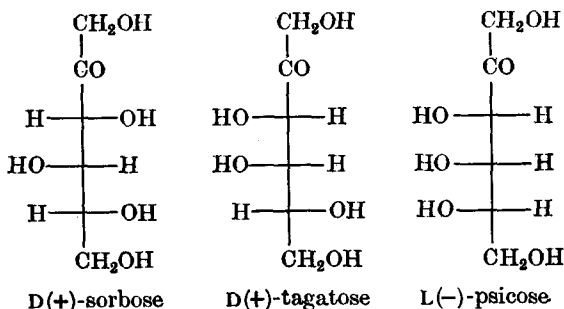

**§2. Ring structure of the monosaccharides.** When a monosaccharide is dissolved in water, the optical rotatory power of the solution gradually changes until it reaches a constant value (Dubrunfaut, 1846); *e.g.*, a freshly prepared solution of glucose has a specific rotation of  $+111^\circ$ , and when this solution is allowed to stand, the rotation falls to  $+52.5^\circ$ , and remains constant at this value. The final stage can be reached more rapidly either by heating the solution or by adding some catalyst which may be an acid or a base. This change in specific rotation is known as **mutarotation**; all *reducing* sugars (except a few ketoses) undergo mutarotation.

To account for mutarotation, Tollens (1883) suggested an oxide ring structure for D(+)-glucose, whereby *two* forms would be produced, since, in the formation of the ring, another asymmetric carbon atom (which can exist in *two* configurations) is produced (*cf.* the Kiliani reaction). Tollens assumed that a five-membered ring (the  $\gamma$ -form) was produced:

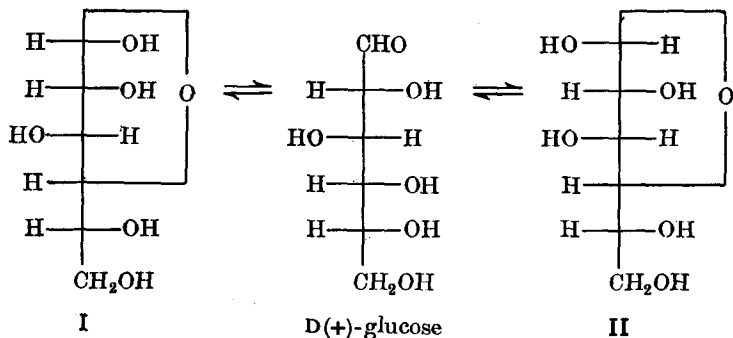

The difficulty of this suggestion was that there was no experimental evidence for the existence of these two forms. Tanret (1895), however, isolated two

isomeric forms of D(+)-glucose, thus apparently verifying Tollens' supposition (but see §§7a, 7f). The two forms, I and II, are known respectively as  $\alpha$ - and  $\beta$ -D(+)- $\gamma$ -glucose (see also §7b for the nomenclature of these forms).

Ring formation of a sugar is really hemiacetal formation, one alcoholic group of the sugar forming a hemiacetal with the aldehyde group of the same molecule, thus producing a ring structure which is known as the *lactol* form of the sugar.

**Mechanism of mutarotation.** According to Lowry (1925), mutarotation is not possible without the presence of an amphiprotic solvent, *i.e.*, a solvent which can function both as an acid and a base, *e.g.*, water. Thus Lowry and Faulkner (1925) showed that mutarotation is arrested in pyridine solution (basic solvent) and in cresol solution (acidic solvent), but that it takes place in a mixture of pyridine and cresol. It has been assumed that when mutarotation takes place, the ring opens and then recloses in the inverted position or in the original position. There is some evidence for the existence of this open-chain form. The absorption spectra of fructose and sorbose in aqueous solution indicate the presence of open-chain forms; aldoses gave negative results (Bednarczyk *et al.*, 1938). Solutions of glucose and arabinose in 50 per cent. sulphuric acid gave an ultraviolet absorption spectrum containing the band characteristic of the oxo (carbonyl) group (Pascu *et al.*, 1948). Aldoses in solution contain a form which is reducible at the dropping mercury electrode (Cantor *et al.*, 1940). Although the nature of this reducible form has not been established, it is probably the open-chain form, either free or hydrated. Furthermore, a relationship was shown to exist between the amount of this reducible form and the rate of mutarotation. One interpretation of this observation is that the reducible form is an intermediate in mutarotation. Rate constants for the conversion of the ring forms of aldoses to the open-chain form have been calculated from polarographic measurements, and it has also been shown that the energy of activation required to open the pyranose ring is the same for glucose, mannose, galactose, arabinose and xylose (Delahay *et al.*, 1952). The formation of this acyclic intermediate during mutarotation has been confirmed by isotopic evidence (Goto *et al.*, 1941) and by further polarographic evidence

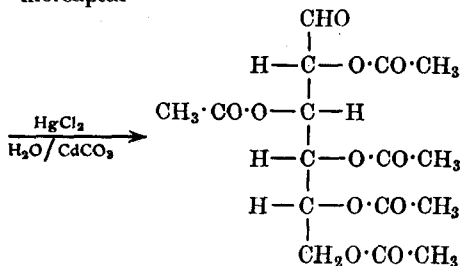
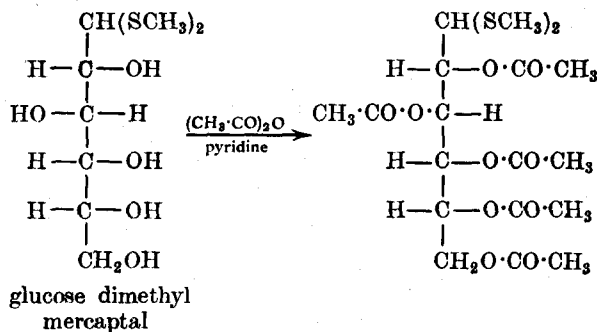



(Overend *et al.*, 1957). It is interesting to note in connection with this problem of the existence of the open-chain structure, that *aldehydo-sugars*, *i.e.*, aldoses in which the aldehyde group is present, can only be *isolated* if all the hydroxyl groups in the *open-chain form* are "protected"; *e.g.*, Wolfrom (1929) prepared 2:3:4:5:6-penta-acetylaldehydoglucose as shown at foot of previous page.

The problem now is: What is the mechanism of the formation of the open-chain form from the ring-form? Lowry (1925) suggested that it occurred by the simultaneous addition and elimination of a proton, since both an acid and a base must be present (see above). This concerted mechanism would conform to a third-order reaction:

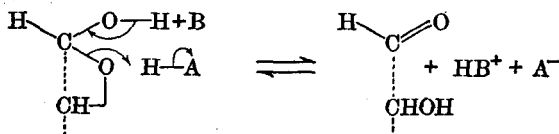

Swain *et al.* (1952) have shown that the mutarotation of tetramethylglucose, catalysed by phenol and pyridine in benzene solution, is a third-order reaction; this supports the above mechanism. On the other hand, some authors believe that the reaction proceeds in two independent ways, one being an acid-catalysed reaction, and the other a base-catalysed reaction. In this case the mechanism would conform to a second-order reaction. Hill *et al.* (1952) have shown that the mutarotation of glucose in aqueous methanol containing acetate buffers is in better agreement with a second-order reaction than with a third-order.

It can thus be seen that the mechanism of mutarotation cannot be regarded as settled, and it appears likely that the sugar investigated (free or as a derivative) and the experimental conditions may play a part in deciding which mechanism will operate (see §7h).

**Preparation of the  $\alpha$ - and  $\beta$ -forms of a sugar.** Experimentally, it is very difficult to isolate the  $\alpha$ - and  $\beta$ -forms of a sugar. The ordinary form of D(+)-glucose is the  $\alpha$ -isomer, m.p. 146° and  $[\alpha]_D = +111^\circ$ ; this form may be prepared by crystallising glucose from cold ethanol. The  $\beta$ -isomer, m.p. 148–150°,  $[\alpha]_D = +19.2^\circ$ , can be obtained by crystallising glucose from hot pyridine. Thus the  $\alpha$ -form may be converted into the  $\beta$ -, and *vice versa*, during the process of crystallisation; this is an example of asymmetric transformation (§10 iv. II). Both forms show mutarotation, the final value of the specific rotation being +52.5°; this corresponds to a mixture containing about 38 per cent. of the  $\alpha$ -isomer, and 62 per cent. of the  $\beta$ -. The two stereoisomeric ring-forms of a sugar are often referred to as *anomers*.

**Summary of the evidence for the ring structures of sugars.** The cyclic structure of the sugars accounts for the following facts:

(i) The existence of two isomeric forms (anomers) of a given sugar, *e.g.*,  $\alpha$ - and  $\beta$ -glucose.

(ii) Mutarotation.

(iii) Glucose and other aldoses do not give certain characteristic reactions of aldehydes, *e.g.*, Schiff's reaction, do not form a bisulphite or an aldehyde-ammonia compound. Recently, however, it has been shown that by preparing Schiff's reagent in a special way, it becomes very sensitive, simple aldoses restoring the pink colour to this solution; the monosaccharide aldoses react strongly, but the disaccharide aldoses react weakly (Tobie, 1942). This reaction with a sensitive Schiff's reagent appears to indicate that some, although a very small amount, of the open-chain form of a sugar is present in solution in equilibrium with the two ring-forms.

(iv) Glucose penta-acetate does not react with hydroxylamine; this

indicates that the aldehyde group is absent in this derivative (glucose itself does form an oxime).

(v) Aldehydes normally form acetals by combination with two molecules of a monohydric alcohol; aldoses (and ketoses) combine with only one molecule of an alcohol. It should be noted, however, that aldoses will combine with *two* molecules of a thiol to form a mercaptal (thioacetal).

(vi) X-ray analysis definitely proves the existence of the ring structure, and at the same time indicates the size of the ring (see §7f).

**§3. Glycosides.** Just as simple hemi-acetals react with another molecule of an alcohol to form acetals, so can the sugars, in their ring-forms (lactols), react with a molecule of an alcohol to form the acetal derivative, which is known under the generic name of **glycoside**; those of glucose are known as *glucosides*; of fructose, *fructosides*, etc. The hydroxyl group produced at the oxo group by ring formation is known as the *glycosidic hydroxyl group*. This group can be acetylated and methylated, as can all the other hydroxyl groups in the sugar, but the glycoside derivatives are far more readily decomposed by various reagents.

E. Fischer (1893) refluxed glucose in methanol solution in the presence of one-half per cent. hydrochloric acid, and thereby obtained a white crystalline product which contained *one* methyl group (as shown by analysis), and which did not reduce Fehling's solution or mutarotate, and did not form an osazone. Thus the hemiacetal structure is no longer present in this compound; in fact, this compound appears to be an acetal since it is stable in alkaline solution (Fehling's solution). Furthermore, on boiling with dilute inorganic acids, the compound regenerated the original sugar, a reaction again typical of acetals. Ekenstein (1894) isolated a second isomer from the reaction mixture when he repeated Fischer's work, and Fischer explained the existence of these two isomers by suggesting ring structures for the two methyl glucosides, *viz.*,

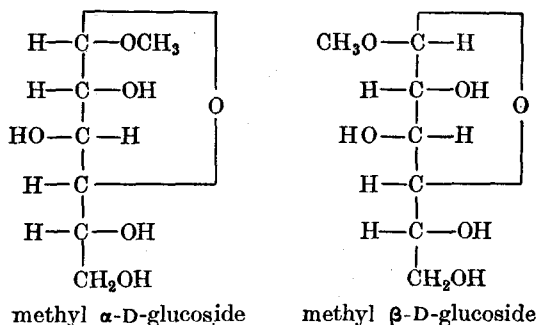

Fischer assumed that these methyl glucosides were five-membered ring systems, basing his assumption on Tollens' suggestion (§2). As we shall see later (§7a), Fischer's assumption is incorrect.

The non-sugar part of a glycoside is known as the *aglycon* (or *aglycone*), and in many glycosides that occur naturally, the aglycon is often a phenolic compound (see §24).

Fischer (1894) found that methyl  $\alpha$ -D-glucoside was hydrolysed by the enzyme maltase, and the  $\beta$ -D-glucoside by the enzyme emulsin. Furthermore, Fischer also found that maltase would not hydrolyse the  $\beta$ -glucoside, and that emulsion would not hydrolyse the  $\alpha$ -glucoside. Thus the two isomers can be distinguished by the specificity of action of certain enzymes (see also §16, XIII). Armstrong (1903) followed these enzymic hydrolyses polarimetrically, and showed that methyl  $\alpha$ -D-glucoside liberates  $\alpha$ -D-glucose,

and that the  $\beta$ -glucoside liberates  $\beta$ -D-glucose; Armstrong found that hydrolysis of the  $\alpha$ -glucoside produced a "downward" mutarotation, whereas that of the  $\beta$ -glucoside produced an "upward" mutarotation. It therefore follows that  $\alpha$ -D-glucose is stereochemically related to methyl  $\alpha$ -D-glucoside, and  $\beta$ -D-glucose to methyl  $\beta$ -D-glucoside.

§4. Configuration of C<sub>1</sub> in glucose. The configurations of C<sub>1</sub> in  $\alpha$ - and  $\beta$ -D-glucose have been written, in the foregoing account, as:

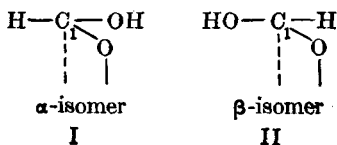

The question that now confronts us is: What justification is there for this choice, *i.e.*, what is the evidence that enables us to say that the  $\alpha$ -isomer (characterised by certain physical constants) actually has the hydrogen atom to the left and the hydroxyl group to the right? Hudson (1909) proposed the *empirical* rule that of an  $\alpha$ ,  $\beta$  pair of sugars in the D-series, the  $\alpha$ -isomer, which has the *higher* dextrorotation (*i.e.*, this physical constant decides which of the two is to be designated  $\alpha$ -), has the hydrogen to the left (*i.e.*, I); the  $\beta$ -isomer consequently has the hydrogen atom to the right (II). Thus  $\alpha$ -D(+)-glucose is the isomer with the specific rotation  $+111^\circ$ , and  $\beta$ -D(+)-glucose is the isomer with the specific rotation  $+19.2^\circ$ . If the D-sugar has a negative rotation, then, according to the empirical rule, the  $\beta$ -isomer has the higher negative rotation (*i.e.*, the less positive rotation), *e.g.*,  $\alpha$ -D(-)-fructose is the isomer with the specific rotation  $-20^\circ$ , and the  $\beta$ -isomer  $-133^\circ$ . In the L-sugars, the  $\alpha$ -isomer is the one with the *higher* lævorotation, and the other is the  $\beta$ -isomer; thus the  $\alpha$ -forms (and the  $\beta$ -forms) of the D- and L-series are enantiomorphous.

Bösesken (1913) found that when boric acid is added to a solution of a cyclic 1 : 2-glycol, the electrical conductivity of the solution is greater than that of boric acid itself, and that the increase is greater for the *cis*-isomer than for the *trans*- (see Vol. I). This phenomenon has been used to distinguish between the two anomers of D-glucose; the results obtained showed that the conductivity of the isomer called the  $\alpha$  (from the above empirical rule), in the presence of boric acid, decreased during mutarotation, whereas the conductivity of the  $\beta$ -isomer increased. This suggests that the  $\alpha$ -isomer has configuration III, and the  $\beta$ -isomer IV. Thus we now have physico-chemical evidence that the 1 : 2-hydroxyl groups are in the *cis*-position in

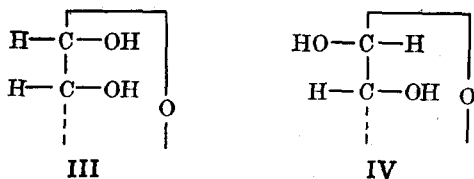

the  $\alpha$ -isomer, *i.e.*, there is now some experimental evidence in support of Hudson's empirical rule. These configurations have been confirmed by further work, *e.g.*, Rüber (1931) found that, in general, *trans*-compounds have a higher molecular refraction than the corresponding *cis*-; the molecular refraction of  $\beta$ -D-glucose is greater than that of the  $\alpha$ -isomer, and so agrees with the results obtained by the conductivity experiments. The strongest bit of evidence for the configurations of the  $\alpha$ - and  $\beta$ -isomers has been obtained from X-ray studies of  $\alpha$ -D-glucose (see §7f).

§5. **Hudson's lactone rule.** Hudson (1910) studied the rotation of the lactones derived from the aldonic acids. Using the usual projection formulæ, the lactone ring will be on the right or left according as the hydroxyl group on  $C_4$  (*i.e.*, the  $\gamma$ -hydroxyl group) is on the right or left, *i.e.*, according as  $C_4$  has a *dextro* or *lævo* configuration:

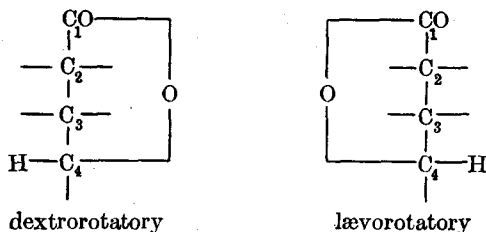

From an examination of 24 lactones derived from aldonic acids, and assuming that they were  $\gamma$ -lactones, Hudson concluded that if the lactone ring was on the right, the compound was dextrorotatory; if the ring was on the left, then lævorotatory.

§6. **Hudson's isorotation rules.** Hudson (1909, 1930) applied the rule of optical superposition (§12. I) to carbohydrate chemistry, and his first application was to the problem of the configuration of  $C_1$  in the anomers of aldoses. Hudson pointed out that the only structural difference between the  $\alpha$ - and  $\beta$ -anomers (of sugars and glycosides) is the configuration of  $C_1$ . Thus, representing the rotation of this terminal group as A and that of the rest of the molecule as B, and then taking the  $\alpha$ -anomer as the one with the higher positive rotation (in the D-series) we have:

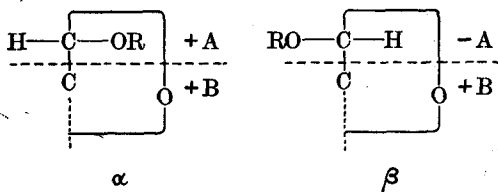

$$\begin{aligned} \text{Molecular rotation of the } \alpha\text{-anomer} &= +A + B \\ \text{'' '' '' '' } \beta\text{-''} &= -A + B \end{aligned}$$

Thus in every pair of  $\alpha$ - and  $\beta$ -anomers the following rules will hold:

*Rule 1.* The sum of the molecular rotations (2B) will be a constant value characteristic of a particular sugar and independent of the nature of R.

*Rule 2.* The difference of the molecular rotations (2A) will be a constant value characteristic of R.

As we have seen, the rule of optical superposition does not hold exactly (due to neighbouring action, etc.; see §12. I). In the sugars, however, the rotation of  $C_1$  is affected only to a small extent by changes in the rest of the molecule, and *vice versa*. This is illustrated in the following table, from which it can be seen that the sum of the molecular rotations (2B) for various pairs of glucopyranoside anomers is fairly constant.

$C_1$ substituent	$M_\alpha$	$M_\beta$	$M_\alpha + M_\beta = 2B$
OH . . . . .	+202	+34	+236
OCH <sub>3</sub> . . . . .	+309	-66	+243
OC <sub>2</sub> H <sub>5</sub> . . . . .	+314	-69.5	+245.5

These isorotation rules have been used to ascertain which of an anomeric pair of glycosides is  $\alpha$  and which is  $\beta$ , and to determine the type of glycosidic link in disaccharides and polysaccharides.

Lemieux *et al.* (1958), by means of proton magnetic resonance studies, have shown that the configurations assigned to the  $\alpha$ - and  $\beta$ -anomers of sugar acetates on the basis of Hudson's rules are correct.

**§7. Methods for determining the size of sugar rings.** As pointed out previously, Fischer followed Tollens in proposing the  $\gamma$ -oxide ring. There was, however, no experimental evidence for this; the  $\gamma$ -hydroxyl group was chosen as being involved in ring formation by analogy with the ready formation of  $\gamma$ -lactones from  $\gamma$ -hydroxyacids. The problem was further complicated by the fact that Hudson *et al.* (1915) isolated four galactose penta-acetates, none of which had a free aldehyde group. Furthermore, these four compounds were related to each other as pairs, *i.e.*, there were two  $\alpha$ - and two  $\beta$ -isomers. The only reasonable explanation for this was that there are *two* ring systems present, but once again there is no evidence to decide the actual sizes of the rings.

The original experimental approach to the problem of determining the size of the ring present in sugars consisted essentially in studying the methylated sugars. A more recent method uses the methyl glycosides (for this method, see §7g). Since methylation is so important in the original method, the following account describes briefly the methods used.

(i) *Purdie's method* (1903). The sugar is first converted into the corresponding methyl glycoside (methanol and hydrochloric acid), and this is then heated with methyl iodide in the presence of *dry* silver oxide; thus:

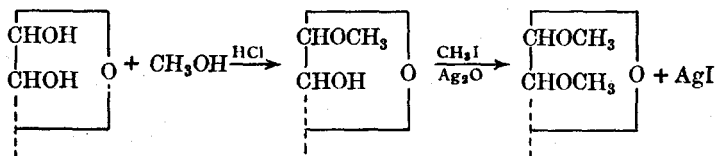

Purdie's method is only applicable to glycosides and other derivatives in which the *reducing group* is missing or has been protected by substitution. Methylation of a free reducing sugar by this method would result in the oxidation of that sugar by the silver oxide.

In certain cases, thalious hydroxide may be used instead of silver oxide (Fear *et al.*, 1926).

(ii) *Haworth's method* (1915). In this method methyl sulphate and aqueous sodium hydroxide are added to a well-stirred sugar solution at such a rate that the liquid remains practically neutral:

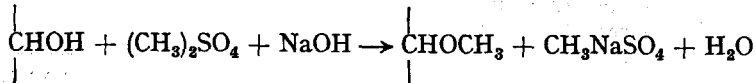

This method is directly applicable to all reducing sugars.

(iii) More recent methods of methylation use sodium and methyl iodide in liquid ammonia, or diazomethane in the presence of moisture.

Having obtained the fully methylated methyl glycoside, the latter is then hydrolysed with dilute hydrochloric acid, whereby the glycosidic methyl group is eliminated. A study of the oxidation products of the methylated sugar then leads to the size of the ring. It should be noted that throughout the whole method, the assumption is made that no methyl groups migrate or that any change in the position of the oxide ring occurs (see, however, later). The number of methyl groups present in the methylated sugar and

the various oxidation products are determined by the Zeisel method (see Vol. I). Also, these methyl derivatives are often purified by distillation *in vacuo*. Bishop *et al.* (1960) have now separated methylated methyl glycosides by gas chromatography.

**§7a. Pyranose structure.** This structure is also sometimes referred to as the  $\delta$ -oxide or amylenoxide ring. As an example of the method used, we shall consider the case of D(+)-glucose (Haworth and Hirst, 1927). D(+)-Glucose, I, was refluxed in methanol solution in the presence of a small amount of hydrochloric acid, and the methyl D-glucoside, II, so produced was methylated with methyl sulphate in the presence of sodium hydroxide to give methyl tetramethyl-D-glucoside, III, and this, on hydrolysis with dilute hydrochloric acid, gave tetramethyl-D-glucose, IV. When this was dissolved in water and then oxidised by heating with excess of bromine at 90°, a lactone, V, was isolated, and this, on further oxidation with nitric acid, gave xylotrimethoxyglutaric acid, VI. The structure of this compound is known, since it can be obtained directly by the oxidation of methylated xylose; thus its structure is VI (see also §7d). The structure of this

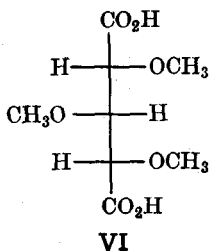

compound is the key to the determination of the size of the ring in the sugar. One of the carboxyl groups in VI must be that which is combined in the formation of the lactone ring in the tetramethylgluconolactone, V. The other carboxyl group is almost certainly the one that has been derived from the non-methylated carbon atom, *i.e.*, from the CHOH group that is involved in the ring formation in the sugar. Therefore there must be *three* methoxyl groups in the lactone ring. Thus the lactone *cannot* be a  $\gamma$ -lactone, and consequently C<sub>5</sub> must be involved in the ring formation. It therefore follows that the lactone, V, must be 2 : 3 : 4 : 6-tetra-*O*-methyl-D-gluconolactone. Working *backwards* from this compound, then IV must be 2 : 3 : 4 : 6-tetra-*O*-methyl-D-glucose, III methyl 2 : 3 : 4 : 6-tetra-*O*-methyl-D-glucoside, II methyl D-glucopyranoside, and I D-glucopyranose (see §7f for the significance of the term pyranose). It should be noted that the question as to whether the sugar is  $\alpha$  or  $\beta$  has been ignored; starting with either leads to the same final results. The foregoing experimental results can now be represented by the following equations:

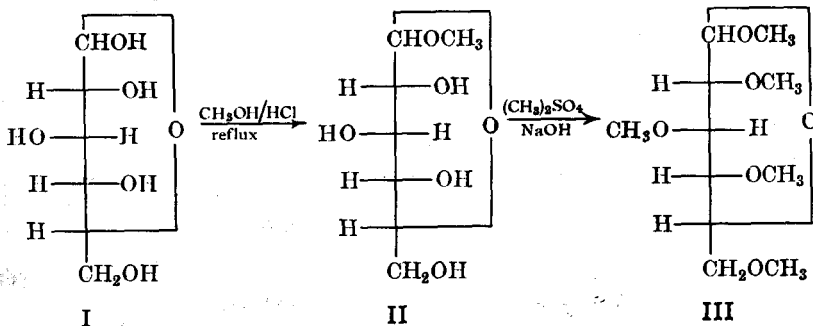

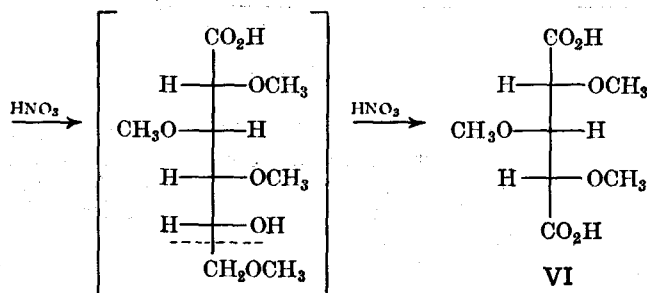
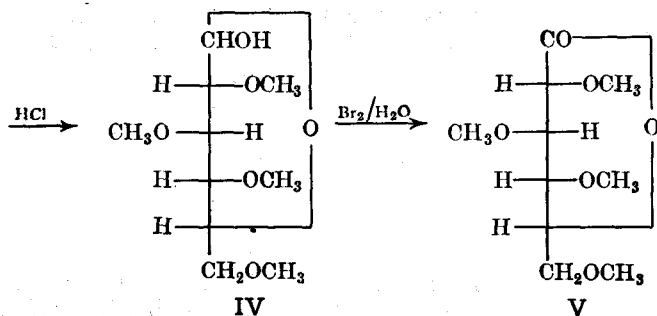

There is a slight possibility that the ring might have been an  $\epsilon$ -ring, *i.e.* the oxide ring involves  $C_1$  and  $C_6$ , and that  $C_5$  is converted to the carboxy group with loss of  $C_6$ . Haworth, however, made certain that this was not the case by the following method. Had the ring been 1 : 6-, then 2 : 3 : 4 : 5-tetramethylgluconic acid, VII, would have been obtained (instead of V). VII was obtained by Haworth *et al.* (1927) from melibiose and gentiobiose (see §§18, 19) and, on oxidation, gave tetramethylsaccharic acid, VIII, and not the dicarboxylic acid, VI.

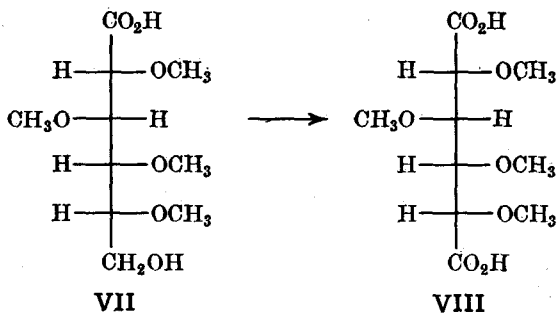

Thus there is a 1 : 5-ring in the tetramethylgluconolactone, tetra-*O*-methylglucose, methyl tetra-*O*-methylglucoside, methyl glucoside, and *therefore in glucose itself*. This conclusion is based on the assumption that no change in the ring position occurs during the methylation of glucose. Thus glucose is a  $\delta$ - or pyranose sugar.

By similar methods it has been shown that hexoses and pentoses all possess a pyranose structure. There is also a large amount of evidence to

show that the oximes, phenylhydrazones and osazones of hexoses and pentoses may be cyclic or open-chain, *e.g.*, the oxime of glucose:

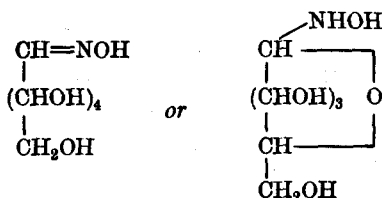

Mester *et al.* (1951–1955) showed that aldose phenylhydrazones react in pyridine solution with solutions of diazonium salts to give brilliant-red sugar diphenylformazans:

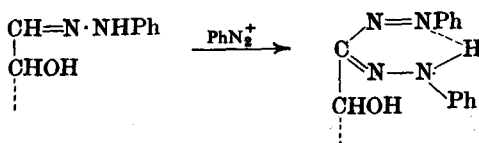

Formazan formation proves the acyclic structure of the sugar phenylhydrazones. The cyclic structures do not react, *e.g.*, there are three modifications of D-glucose phenylhydrazone ( $\alpha$ , m.p. 159–160°;  $\beta$ , m.p. 140–141°;  $\gamma$ , m.p. 115–116°); two of these do not form formazans, but the third does. Hence the former two are cyclic and the third is acyclic.

**§7b. Furanose structure.** This structure is also sometimes referred to as the  $\gamma$ -oxide or butylene oxide ring. Fischer (1914) prepared methyl D(+)-glucoside by a slightly modified method, *viz.*, by dissolving D(+)-glucose in methanol, adding one per cent. hydrochloric acid, and then allowing the mixture to stand at 0° (instead of refluxing, as in his first procedure). On working up the product, he obtained a syrup (a crystalline compound was obtained by the first procedure). Fischer called this compound methyl  $\gamma$ -glucoside, and believed it was another isomer of the  $\alpha$ - and  $\beta$ -forms; this is the significance of the symbol  $\gamma$  as used by Fischer. This syrup, however, was subsequently shown to be a mixture of methyl  $\alpha$ - and  $\beta$ -glucofuranosides, *i.e.*, this glucoside contained a  $\gamma$ - or 1:4-ring (Haworth *et al.*, 1927). This syrup, I, when completely methylated (methyl sulphate method), gave a methyl tetra-*O*-methyl-D-glucoside, II, and this, on hydrolysis with dilute hydrochloric acid, gave tetra-*O*-methyl-D-glucose, III. On oxidation with bromine water at 90°, III gave a crystalline lactone, IV, and this, when oxidised with nitric acid, gave dimethyl-D-tartaric (dimethoxysuccinic) acid, V. This compound (V) is the only compound of known structure, and is therefore the key to the determination of the size of the ring in the sugar. Working *backwards* from V, then IV is 2:3:5:6-tetra-*O*-methyl-D-gluconolactone, III is 2:3:5:6-tetra-*O*-methyl-D-glucose, II is methyl 2:3:5:6-tetra-*O*-methyl-D-glucoside, and I is methyl D-glucofuranoside. If we write D-glucose as D-glucofuranose, then the foregoing reactions may be formulated as shown on next page (see §7f for the meaning of furanose).

These reactions prove that I, II, III and IV all contain a  $\gamma$ -oxide ring, *i.e.*, the methyl glucoside, I, prepared at 0°, has a 1:4-ring. This then raises the question: What is the size of the ring in glucose itself? Is it 1:4 or 1:5? Preparation of the methyl glucoside at reflux temperature gives the 1:5-compounds (see §7a); preparation at 0° gives the 1:4-compounds. It is therefore not possible to say from these experiments whether glucose itself exists in the pyranose (1:5-) or furanose (1:4-) forms originally, or whether these two forms are in equilibrium. Further information is neces-



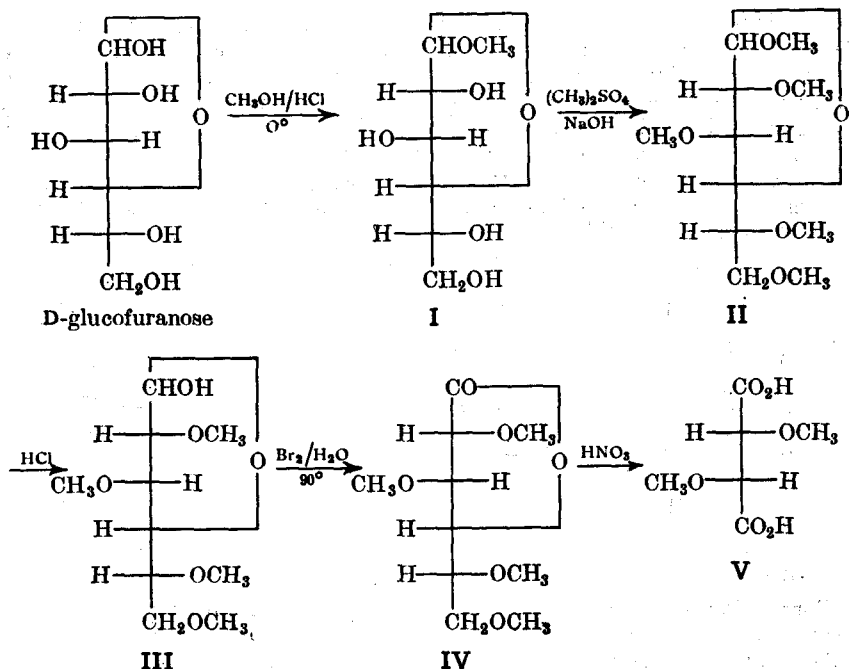

sary to supply an answer to these questions. As we shall see later, the normal form of a sugar is the pyranose structure (see §7f); pyranosides are often referred to as the "normal" glycosides.

By similar methods it has been shown that hexoses and pentoses give methyl glycosides possessing a furanose structure when prepared at  $0^\circ$  (or at room temperature).

### §7c. Determination of ring size by means of lactone formation.

As we have seen, glycoside formation at *reflux* temperature leads ultimately to a methylated  $\delta$ -lactone, whereas at  $0^\circ$  a methylated  $\gamma$ -lactone is obtained. Haworth (1927) examined the rates of hydration of these two types of lactones to the open-chain acids; the rates were measured by changes in the rotation or conductivity. Haworth found that the rate of hydration was much faster in one series than in the other; the  $\delta$ -lactones were converted almost completely to the acids, whereas the  $\gamma$ -lactones were converted at a much slower rate (see Fig. 1). Thus, by comparing the stabilities (to hydration) of the various methylated lactones, it is possible to say whether the lactone under investigation is  $\gamma$ - or  $\delta$ -. It is very important to note

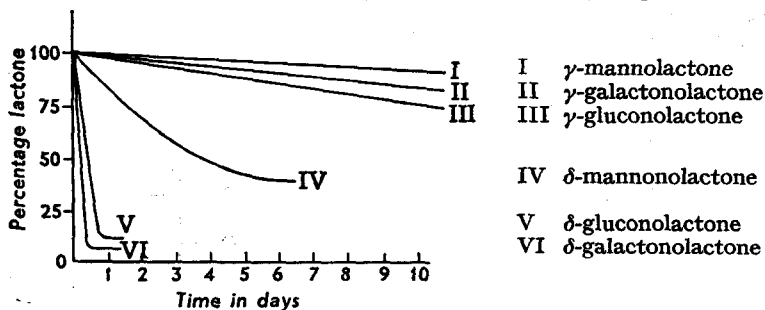
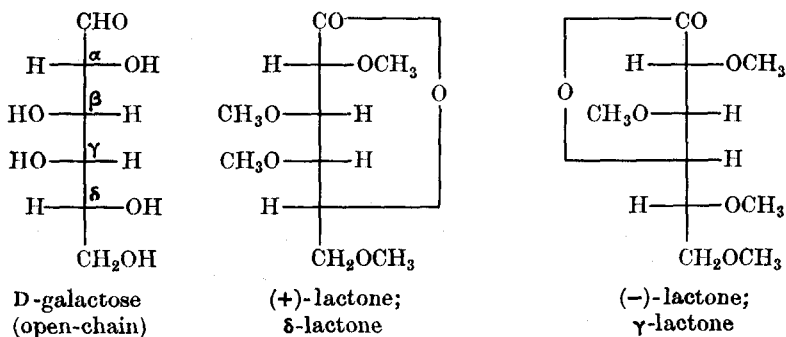

FIG. 7.1.

that this method easily distinguishes a  $\gamma$ - from a  $\delta$ -lactone, but it does not *prove* one to be  $\gamma$ - and the other  $\delta$ -. The actual nature of the lactone was proved *chemically*; the fast-changing lactone was shown to be the  $\delta$ -lactone, and the slow-changing one the  $\gamma$ - (the chemical evidence was obtained by the degradative oxidation already described). However, having once established the relationship between the rate of hydration and the nature of the lactone, *e.g.*, in the case of glucose, mannose, galactose and arabinose, the property can *then* be used to determine the size of the ring in an unknown lactone of a sugar acid.



Correlation between the above scheme and Hudson's lactone rule has been demonstrated in certain cases, *e.g.*, galactose. Preparation of the methyl galactoside at reflux temperature, then methylation, hydrolysis, and finally oxidation with bromine water, leads to the formation of a methylated lactone which is dextrorotatory, and since it is a rapidly hydrated lactone, it must be  $\delta$ -. Preparation of the methyl galactoside at  $0^\circ$ , etc., leads to the formation of a methylated lactone which is lævorotatory and is very stable to hydration. Thus, this lactone will have the ring to the left (Hudson's lactone rule), and hence must be a  $\gamma$ -lactone; at the same time, since it is a slowly hydrated lactone, it must be  $\gamma$ - (see the above formulæ).

**§7d. Pyranose and furanose structures of pentoses.** The methods used for determining the size of sugar rings have been described with glucose (an aldohexose) as the example. It is also instructive to apply these methods to the aldopentoses. L(+)-Arabinose has been chosen as the example, and the following equations and footnotes should now be readily followed:

(i) *Glycoside formation at reflux temperature* (Haworth *et al.*, 1927).

I is L(+)-arabinopyranose, and since it is *dextrorotatory*, the ring has been drawn to the *right*. This way of drawing the projection formula is based on the observation of Haworth and Drew (1926), who pointed out that if a ring in a sugar is 1 : 5- (*i.e.*,  $\delta$ -), then Hudson's lactone rule holds good for sugars as for  $\gamma$ -lactones.

II is 2 : 3 : 4-tri-*O*-methyl-L-arabinose.

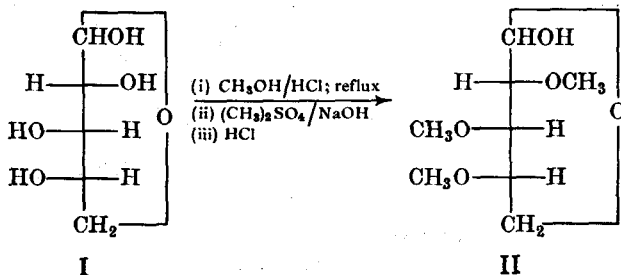

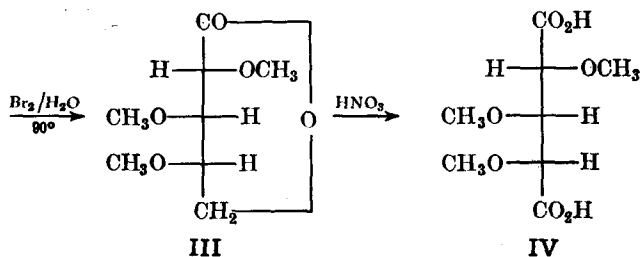

III is 2 : 3 : 4-tri-*O*-methyl-L-arabinolactone; it is a  $\delta$ -lactone as shown by oxidation to IV, and also by the fact that it is of the type that is readily hydrated.

IV is 2 : 3 : 4-L-arabinotrimethoxyglutaric acid (this is the key compound).

(ii) *Glycoside formation at room temperature* (Haworth *et al.*, 1925, 1927).

V is L-arabinofuranose.

VI is 2 : 3 : 5-tri-*O*-methyl-L-arabinose.

VII is 2 : 3 : 5-tri-*O*-methyl-L-arabinolactone (Hudson's lactone rule, and is slow-changing type).

VIII is dimethyl-D-tartaric acid (this is the key compound).

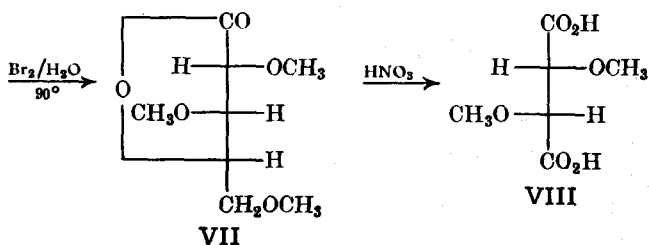
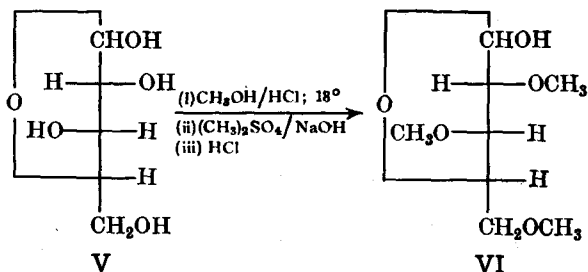

§7e. **Ketose ring structures.** Only D-fructose will be considered; the method is essentially the same as that for the aldoses, but there is one important variation, and that is in the oxidation of the tetramethylfructose. This cannot be oxidised by bromine water as can the tetramethylaldose; the fructose derivative is first oxidised with dilute nitric acid and then with acid permanganate, and by this means the lactone is obtained. The lactone is then further oxidised by moderately concentrated nitric acid. The following equations and footnotes explain the method, but before giving these, let us first consider the way of writing the projection formula of the ring structure of fructose. The usual open-chain formula is I, and to form the ring the ketone group is involved with C<sub>6</sub> in the pyranose form, and with C<sub>5</sub> in the furanose form; each of these can exist as the  $\alpha$ - and  $\beta$ -isomers. When

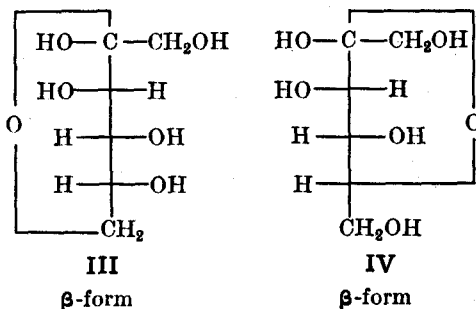
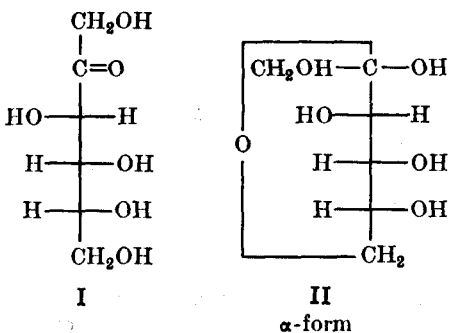

the ring is closed, then if the hydroxyl group is drawn on the right, this will be the  $\alpha$ -isomer (the  $\text{CH}_2\text{OH}$  group now replaces a hydrogen atom in the aldoses). Furthermore, since D-fructopyranose is levorotatory, the oxide ring is drawn to the left (see the comments on L(+)-arabinopyranose, §7d). Thus  $\alpha$ -D(-)-fructopyranose is II, and  $\beta$ -D(-)-fructopyranose is III. The furanose forms are obtained in a similar manner, but in this case the ring must be written to the right since the hydroxyl group on  $\text{C}_5$  is on the right; thus  $\beta$ -D-fructofuranose is IV (see also sucrose, §13).

(i) *Glycoside formation at reflux temperature* (Haworth *et al.*, 1926, 1927).

V is  $\beta$ -D(-)-fructopyranose.

VI is methyl  $\beta$ -D-fructopyranoside.

VII is methyl 1 : 3 : 4 : 5-tetra-O-methyl- $\beta$ -D-fructoside.

VIII is 1 : 3 : 4 : 5-tetra-O-methyl- $\beta$ -D-fructose.

IX is 3 : 4 : 5-tri-O-methyl- $\beta$ -D-fructuronic acid (as lactol).

X is 2 : 3 : 4-tri-O-methyl-D-arabinolactone; this is a quick-changing lactone, and is therefore a  $\delta$ -lactone.

XI is D-arabinotrimethoxyglutaric acid.

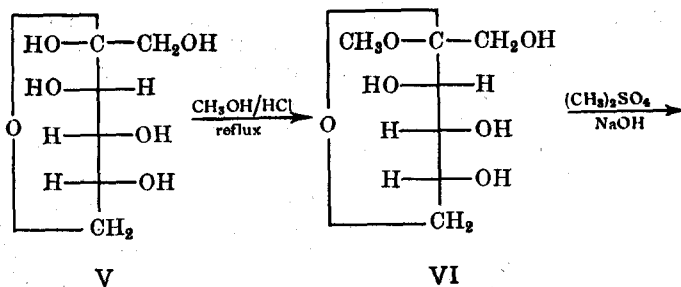

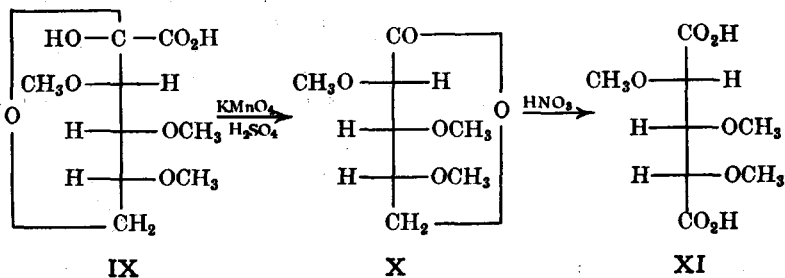
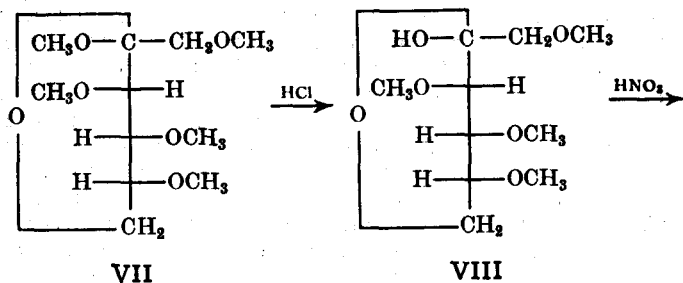

(ii) Glycoside formation at room temperature (Haworth *et al.*, 1927).

XII is  $\beta$ -D-fructofuranose.

XIII is 1 : 3 : 4 : 6-tetra-O-methyl- $\beta$ -D-fructose.

XIV is 3 : 4 : 6-tri-O-methyl- $\beta$ -D-fructuronic acid (as lactol).

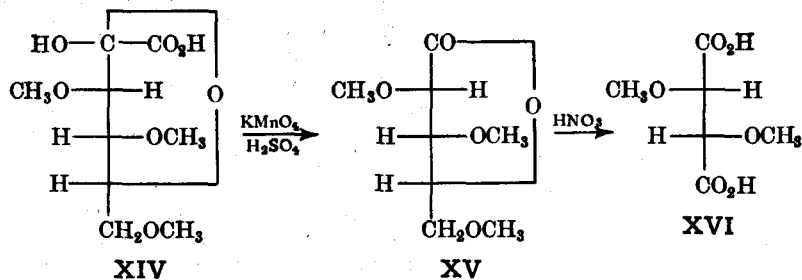
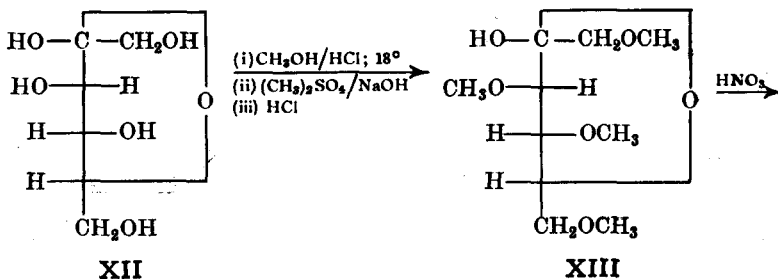

XV is 2 : 3 : 5-tri-O-methyl-D-arabinolactone; this is a slow-changing lactone, and so is  $\gamma$ .

XVI is dimethyl-L-tartaric acid.

**§7f. Conclusion.** From the foregoing account it can be seen that the sugars exist as ring structures and not as open chains. Haworth (1926) therefore proposed a hexagonal formula for  $\delta$ -sugars based on the pyran ring, I. The problem now is to convert the conventional plane-diagrams that we have been using into the *pyranose* formula. Let us take  $\alpha$ -D-glucopyranose, II, as our example. The conventional tetrahedral diagram of II is III (see §5. II). Examination of III shows that the point of attachment of the oxide ring at  $C_1$  is *below* the plane of the paper, and that at  $C_5$  it is *above* the plane of the paper. If the tetrahedron with  $C_5$  at its centre is rotated so that the point of attachment of the oxide ring is placed *below* the plane of the paper, III will now become IV, and the oxide ring will now be *perpendicular* to the plane of the paper, *i.e.*, perpendicular to the plane containing all the other groups (these all lie in a plane above the plane of the paper). The conventional plane-diagram of IV is V, but in order to emphasise the fact that the oxide ring is actually perpendicular to the plane of the paper, the part of the ring lying below the plane of the paper is shown by a broken line (the true plane-diagram should have a normal line drawn

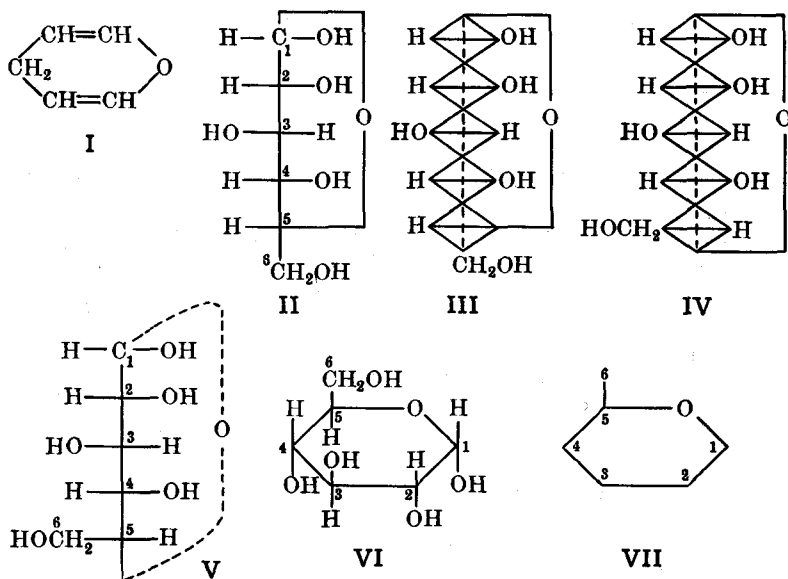

as in II). Comparison of V with II shows that where the CH<sub>2</sub>OH was originally is now the point of attachment of the oxide ring, the CH<sub>2</sub>OH occupying the position where the H atom was, and the latter now where the oxide ring was. Thus, if we consider the conversion of II into V without first drawing III and IV, then in effect *two* Walden inversions have been effected, and consequently the original configuration is retained. V is now transformed into the perspective formula VI by twisting V so that the oxide ring is perpendicular to the plane of the paper and all the other groups are joined to bonds which are parallel to the plane of the paper. By convention, C<sub>1</sub> is placed to the right and the oxygen atom at the right-hand side of the part of the ring furthest from the observer. Sometimes the lower part of the ring, which represents the part nearest to the observer, is drawn in thick lines. Thus, to change V into VI, first draw the hexagon as shown in VI, and then place all the groups on the left-hand side in V above the plane of the ring in VI; all those on the right-hand side in V are placed below the

plane of the ring in VI. VII represents a "short-hand representation" of D-glucose.

In a similar manner, Haworth proposed a five-membered ring for  $\gamma$ -sugars based on the furan ring, VIII. Using the above scheme of transformation, the plane-diagram of methyl  $\beta$ -D-(+)-glucofuranoside, IX, is first changed into X (two changes are carried out), and then X is twisted so as to be represented by XI, in which the oxygen atom is furthest from the observer.

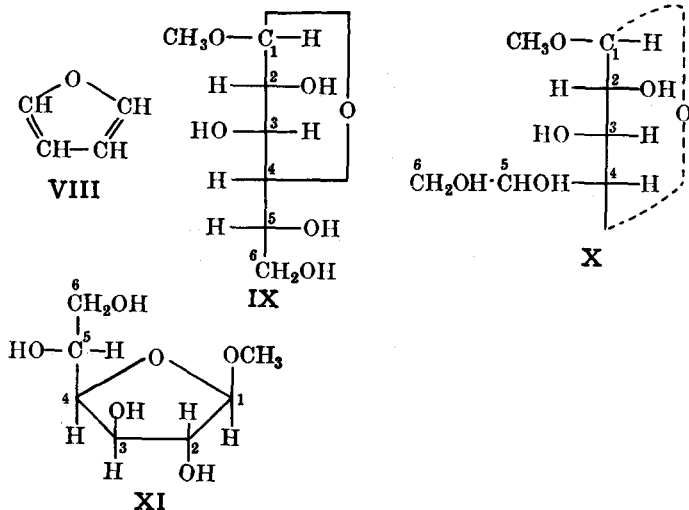

Two other examples which illustrate the conversion into the perspective formula are:

(i)  $\alpha$ -D(-)-fructopyranose.

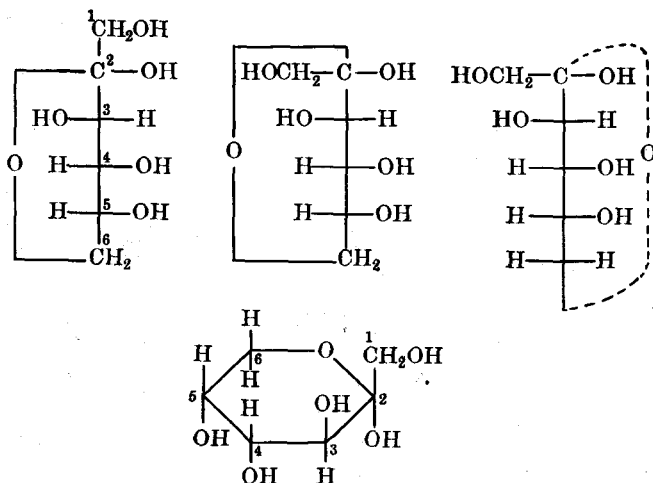

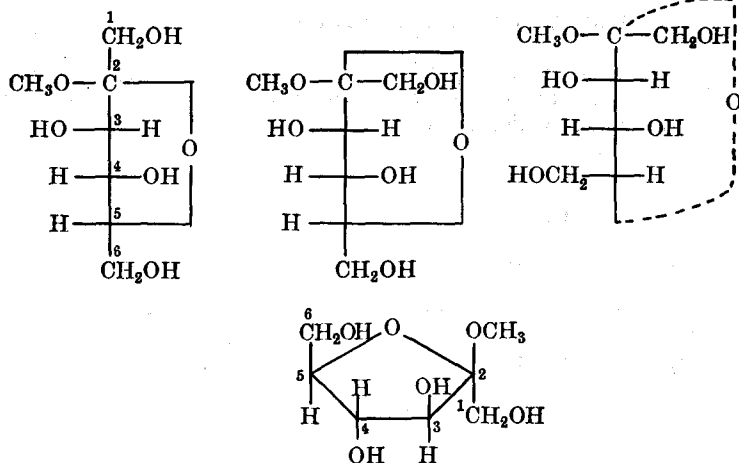
(ii) Methyl  $\beta$ -D(+)-fructofuranoside.

**Actual size of sugar rings.** Since glycoside formation under different conditions gives compounds containing different sized rings, the important question then is: What is the size of the ring in the original sugar? Oxidation of an aldose with hypobromite produces an unstable  $\delta$ -lactone; this is the first product, but slowly changes into the stable  $\gamma$ -lactone (Hudson, 1932). It therefore follows that the size of the ring in *normal* sugars is pyranose. By analogy, ketoses are also believed to exist normally as pyranose compounds. This pyranose structure has been confirmed by X-ray analysis of various crystalline monosaccharides (Cox, 1935). McDonald *et al.* (1950) examined  $\alpha$ -D-glucose by X-ray analysis, and confirmed the presence of the six-membered ring, the configuration as found chemically, and also the *cis* arrangement of the 1:2-hydroxyl groups in the  $\alpha$ -form. Eiland *et al.* (1950) subjected difructose strontium chloride dihydrate to X-ray analysis, and showed the presence of a six-membered ring, and confirmed the configuration found chemically. It might be noted here that furanose sugars have not yet been isolated, but some furanosides have. It is also interesting to note that apparently fructose and ribose *always* occur in compounds as the furanose structure. Barker *et al.* (1959), however, have obtained evidence to show that D-ribose exists as the pyranose form at the moment of dissolution and its mutarotation involves change in size of the ring (*cf.* the fructose residue in sucrose, §13).

**§7g. More recent methods for determining the size of the ring in sugars.** These methods make use of the fact that periodic acid splits 1:2-glycols (Malaprade, 1928); thus periodic acid splits the following types of compounds (see also Vol. I):

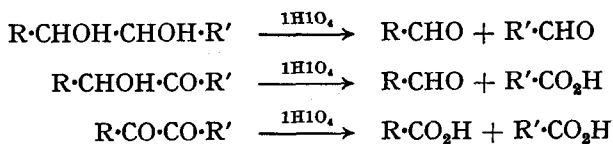

Thus a *free* sugar is broken down completely, *e.g.*,

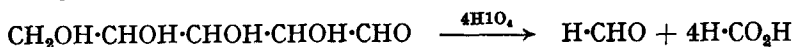



In all of these reactions, one molecule of periodic acid is used for each pair of adjacent alcoholic groups (or oxo groups). Thus, by estimating the periodic acid used, and the formic acid and formaldehyde formed, the number of *free* adjacent hydroxyl groups in a sugar can be ascertained. Hudson (1937, 1939) oxidised "normal" methyl  $\alpha$ -D-glucoside, I, with periodic acid, and found that two molecules of periodic acid were consumed, and that one molecule of formic acid was produced. It should be noted that although periodic acid can completely degrade a *free* sugar, the oxide ring in glycosides is sufficiently stable to resist opening by this reagent. The first product

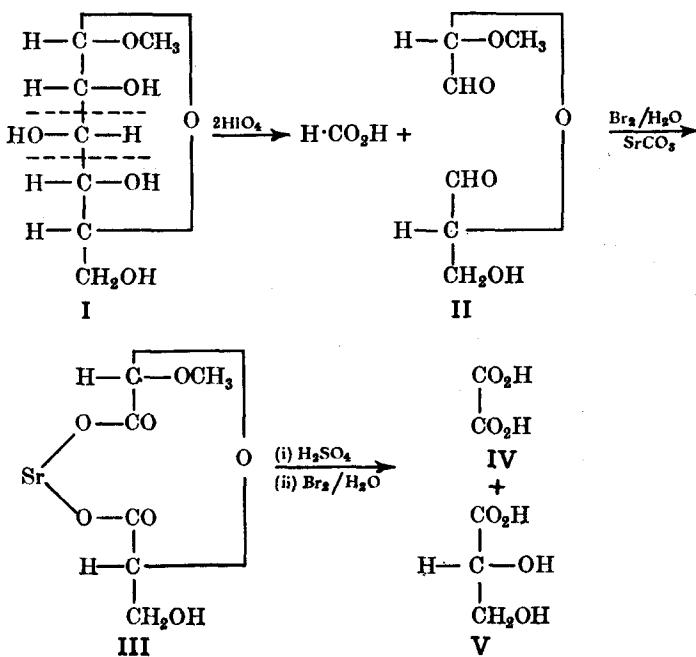

of oxidation of methyl  $\alpha$ -D-glucoside was D'-methoxy-D-hydroxymethylglycolaldehyde, II, and this, on oxidation with bromine water in the presence of strontium carbonate, gave the crystalline salt, III. III, on acidification with sulphuric acid (for hydrolysis), followed by further oxidation with bromine water, gave oxalic acid, IV, and D(-)-glyceric acid, V. Isolation of II, III, IV and V indicates that the ring in I is  $\delta$ -; this is also supported by the fact that only one carbon atom was eliminated as formic acid, and that two molecules of periodic acid were consumed. By similar experiments, it has been shown that all methyl  $\alpha$ -D-hexosides of the "normal" type consume *two* molecules of periodic acid and produce *one* molecule of formic acid, and all also give products II, III, IV and V. Thus all these hexosides must be six-membered rings, and also it follows that all "normal" methyl  $\alpha$ -pyranosides have the same configuration for C<sub>1</sub>; this has already been shown to be VI.

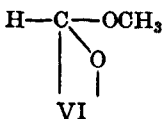

Similarly, all  $\beta$ -compounds, on oxidation with periodic acid, give the stereoisomer of II, *i.e.*, *l'*-methoxy-D-hydroxymethyldiglycolaldehyde.

Aldopentopyranosides also give similar products as those obtained from the aldohexopyranosides, *e.g.*, methyl  $\alpha$ -D-arabinopyranoside, VII, gives D'-methoxydiglycolaldehyde, VIII. Since all methyl  $\alpha$ -D-aldopentopyrano-

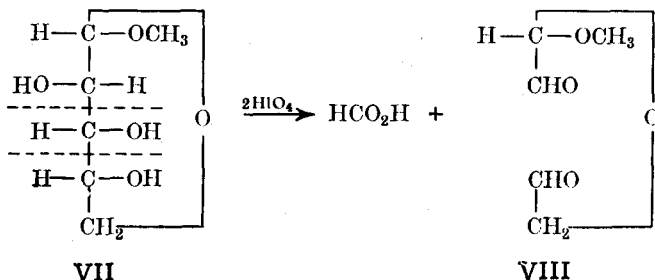

sides give the *same* diglycolaldehyde, they too have the same configuration for  $\text{C}_1$ , *viz.*, VI.

When hexofuranosides, *i.e.*, the "abnormal" glycosides, are oxidised with periodic acid, *two* molecules of acid are consumed and one molecule of *formaldehyde* is formed. These results are in keeping with the presence of a five-membered ring, *e.g.*, methyl  $\alpha$ -D-glucofuranoside.

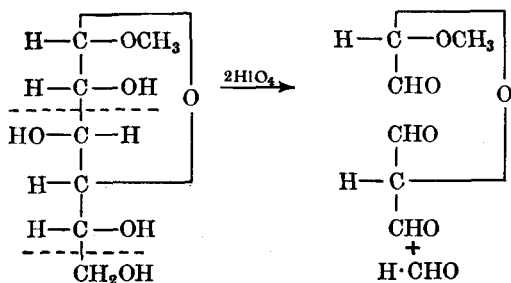

Oxidation of methyl  $\alpha$ -D-arabinofuranoside, IX, consumes *one* molecule of periodic acid, and no carbon atom is eliminated (either as formaldehyde or formic acid); thus the ring is five-membered. Furthermore, since the dialdehyde II obtained is the same as that from methyl  $\alpha$ -D-glucopyranoside, I, the configuration of  $\text{C}_1$  is the same in both I and IX.

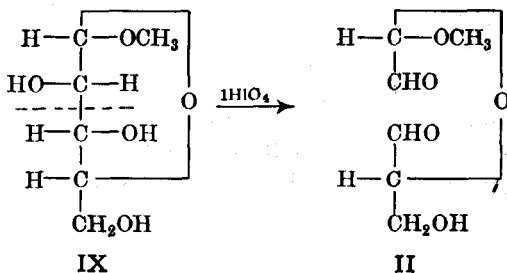

There appears to be some doubt about the structure of II. Various formulæ have been proposed (Hurd *et al.*, 1953; Smith *et al.*, 1955), and

Mester *et al.* (1957) have obtained evidence that of these structures the cyclic hemiacetal (IIa) is the most likely.

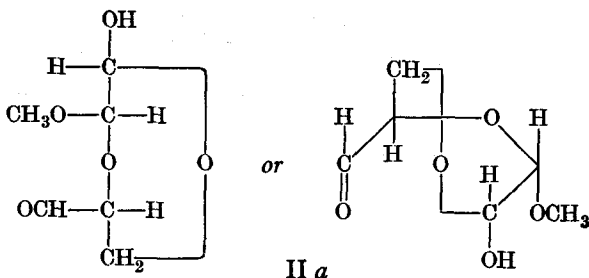

Hough *et al.* (1956) have carried out periodate oxidations on phenylosazones of reducing monosaccharides (X) and obtained formaldehyde, formic acid and mesoxalaldehyde 1 : 2-bisphenylhydrazone (XI). These authors found that XI is obtained from all monosaccharides in which C<sub>3</sub> and C<sub>4</sub> are

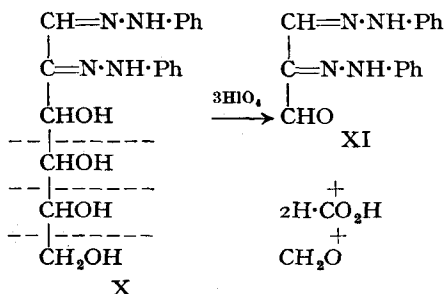

free, and 1 molecule of formaldehyde from the terminal CH<sub>2</sub>OH group when this is free. They also showed that the osazones of the disaccharides maltose (§15), cellobiose (§16), and lactose (§17) did not give XI but did give formaldehyde. Thus C<sub>3</sub> or C<sub>4</sub> are linked in these disaccharides. On the other hand, the oxidation of the osazone of melibiose (§18) gave XI but no formaldehyde; thus C<sub>6</sub> is linked in this molecule. These oxidations therefore offer a means of differentiating between the two types of disaccharides.

**§7h. Conformation of pyranoside rings.** Cyclic 1 : 2-glycols form complexes in cuprammonium solutions, a five-membered ring being produced in which the copper atom is linked to two oxygen atoms. Furthermore, the extent of complex formation depends on the spatial arrangement of the two adjacent hydroxyls, the most favoured position being that in which the two groups and the two carbon atoms to which they are attached lie in one plane. Since complex formation changes the molecular rotation, the molecular rotational shift will indicate the extent of complex formation (*cf.* boric acid complexes, §4). Reeves (1950), using this cuprammonium complex formation, has shown that the pyranose sugars assume a chair form in preference to any boat form wherever both are structurally possible. Substitution of an oxygen atom for a carbon atom in *cyclohexane* causes only minor distortions in the ring (Hassel *et al.*, 1947), and consequently the general conformational features are retained in the pyranose sugars. Reeves (1951) proposed the two regular conformations shown, and named them C1 (the normal chair) and 1C (the reverse chair). Reeves (1958) pointed out that there is an infinite number of skew conformations in which angle strain is

absent. It is still usual, however, to use the regular conformations of Reeves since these are readily related to the Haworth formulæ. Reeves has shown that the C1 conformation is the more stable, and this is supported by Barker *et al.* (1959) who studied the ring structures by periodate oxidations in buffered solutions. Also, according to these authors, the chief exceptions are  $\beta$ -D-altrose,  $\beta$ -D-mannose and  $\beta$ -D-talose, which are considered to be

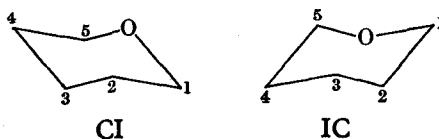

appreciably less stable in the IC conformation.  $\alpha$ -D-Lyxose appears to favour the C1 conformation, and the authors consider that  $\alpha$ -D-allose,  $\beta$ -D-ribose, and  $\alpha$ -D-xylose favour the IC rather than C1 conformation.

As we have seen (§2), D-glucopyranose is an equilibrium mixture (in solution) of the  $\alpha$ - and  $\beta$ -anomers: the conformations of these are:

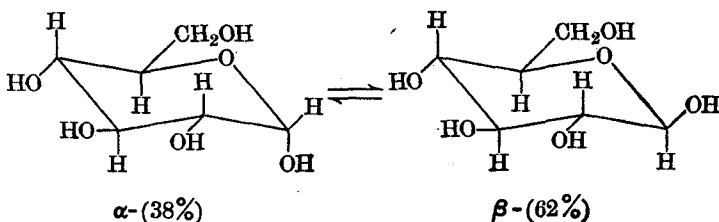

We have also seen that the more stable isomer is the one with the larger number of equatorial substituents, and so the  $\beta$ -form can be expected to be more stable than the  $\alpha$ -. Whiffen *et al.* (1954) have used infra-red spectroscopy to distinguish between  $\alpha$ - and  $\beta$ -anomers; the absorption maxima depend on the axial or equatorial conformation of hydroxyl groups.

In general,  $\beta$ -anomers are more reactive than  $\alpha$ -, *e.g.*, Bunton *et al.* (1954) have shown that acid-catalysed hydrolysis proceeds more rapidly for  $\beta$ -methyl pyranosides than for the corresponding  $\alpha$ -compounds. According to these authors (1955), the hydrolysis proceeds by a unimolecular decomposition of the conjugate acids of the pyranosides. The rate-determining step, however, may be formulated in two ways, both of which are consistent with the evidence available at present.

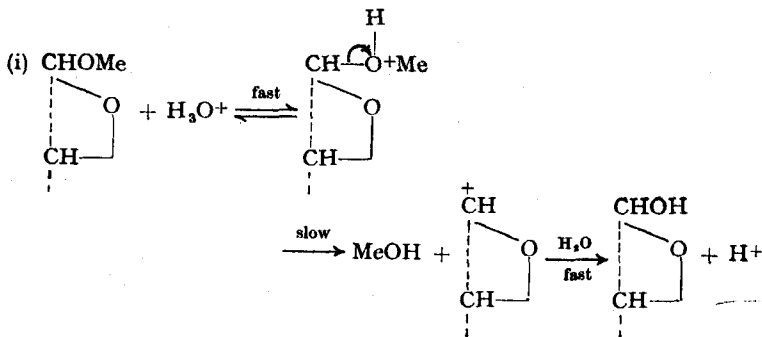

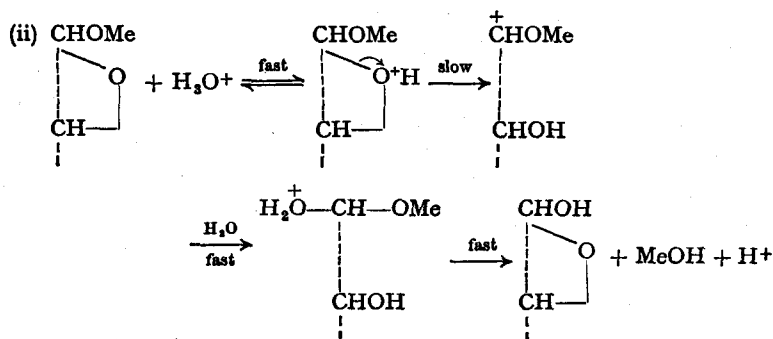

On the other hand, axial hydroxyl groups are less reactive (to esterification and hydrolysis reactions) than equatorial groups (§12. IV). In  $\beta$ -pyranosides, the methoxyl group is equatorial and so mechanism (i) would be more in keeping with the fact that  $\beta$ -anomers are more readily hydrolysed than  $\alpha$ - (in which the methoxyl group is axial). However, Bunton *et al.* (1955) also showed that the rate of hydrolysis depends on the nature of the aglycon. In the above example the aglycon is methyl, but when it is phenyl then it is the  $\alpha$ -anomer which is hydrolysed faster.

Since the hemiacetal linkage in the ring-form of reducing sugars is very labile, reactions involving the carbonyl group may possibly proceed through the acyclic or the cyclic form (see also mutarotation, §2). Isbell *et al.* (1932) have obtained evidence that the oxidation of an aldose with bromine-water proceeds to the 1,5-lactone by direct oxidation of the pyranose form. Isbell *et al.* (1932-1946) also showed that  $\beta$ -D-anomers (equatorial OH at C<sub>1</sub>) are oxidised much faster than the corresponding  $\alpha$ -D-anomers (axial OH at C<sub>1</sub>). Further experiments on the oxidation of D-glucose by bromine-water appear to show that the  $\alpha$ -anomer is first converted into the  $\beta$ -anomer which is then rapidly oxidised directly to  $\delta$ -gluconolactone (Perlmutter-Hayman *et al.*, 1960). Pentoses (except D-lyxose) are also oxidised in the  $\beta$ -form (Overend *et al.*, 1960). Isbell (1961), however, disagrees with Overend's claim that the rate-determining step is the transformation of  $\alpha$ -D-aldopyranoses into the  $\beta$ -anomers.

**§8. *iso*Propylidene derivatives of the monosaccharides.** Sugars condense with anhydrous acetone in the presence of hydrogen chloride, sulphuric acid, etc., at room temperature to form mono- and di-*iso*propylidene (or acetone) derivatives. These are stable towards alkalis, but are readily hydrolysed by acids. In the di-*iso*propylidene derivatives, one *iso*propylidene group is generally removed by hydrolysis more readily than the other, and thus by controlled hydrolysis it is possible to isolate the mono-*iso*propylidene derivative, *e.g.*, di-*iso*propylidene-glucose may be hydrolysed by acetic acid to the mono-derivative.

The structures of these *iso*propylidene derivatives have been determined by the methods used for the sugars themselves, *i.e.*, the compound is first methylated, then hydrolysed to remove the acetone groups, and the product finally oxidised in order to ascertain the positions of the methyl groups. Let us consider D-glucose as an example. This forms a di-*iso*propylidene derivative, I, which is non-reducing; therefore C<sub>1</sub> is involved in the formation of I. On methylation, I forms a monomethyl-di-*iso*propylidene-glucose, II, and this, on hydrolysis with hydrochloric acid, gives a monomethylglucose, III. Hydrolysis of I with acetic acid produces a mono-*iso*propylidene-glucose, IV, which is also non-reducing. Thus C<sub>1</sub> in IV must be combined with the *iso*propylidene radical. Methylation of IV, followed by hydrolysis,

gives a trimethylglucose, V. Methylation of V gives a methyl tetramethylglucoside, and this, on hydrolysis, gives 2 : 3 : 5 : 6-tetra-*O*-methyl-D-glucose, VI, a *known* compound (see §7b). Thus V must be 2 : 3 : 5-, 2 : 3 : 6-, or 3 : 5 : 6-tri-*O*-methyl-D-glucose. Now V forms an osazone without loss of any methyl group; therefore C<sub>2</sub> cannot have a methoxyl group attached to it, and so V must be 3 : 5 : 6-tri-*O*-methyl-D-glucose. Thus one isopropylidene radical in di-*isopropylidene*glucose, I, must be 3 : 5-, 3 : 6- or 5 : 6-. Monomethylglucose, III, on methylation followed by hydrolysis, gives 2 : 3 : 4 : 6-tetra-*O*-methyl-D-glucose, VII, a *known* compound (see §7a). Hence III must be 2-, 3-, 4- or 6-*O*-methyl-D-glucose. Since III gives sodium cyanate when subjected to the Weerman test (see §11), it therefore follows that C<sub>2</sub> has a free hydroxyl group. Oxidation of III with nitric acid produces a monomethylsaccharic acid; therefore C<sub>6</sub> cannot have a methoxyl group attached to it. This monomethylsaccharic acid forms a lactone which behaves as a  $\gamma$ -lactone; therefore a methoxyl group cannot be at C<sub>4</sub>. Thus, by the process of elimination, this monomethylglucose, III, must be 3-*O*-methyl-D-glucose. It therefore follows that the two *isopropylidene* groups in the di-*isopropylidene* derivative must be 1 : 2- and 5 : 6-, the ring being furanose, and the mono-*isopropylidene* derivative being 1 : 2-. The foregoing reactions can be written as on opposite page:

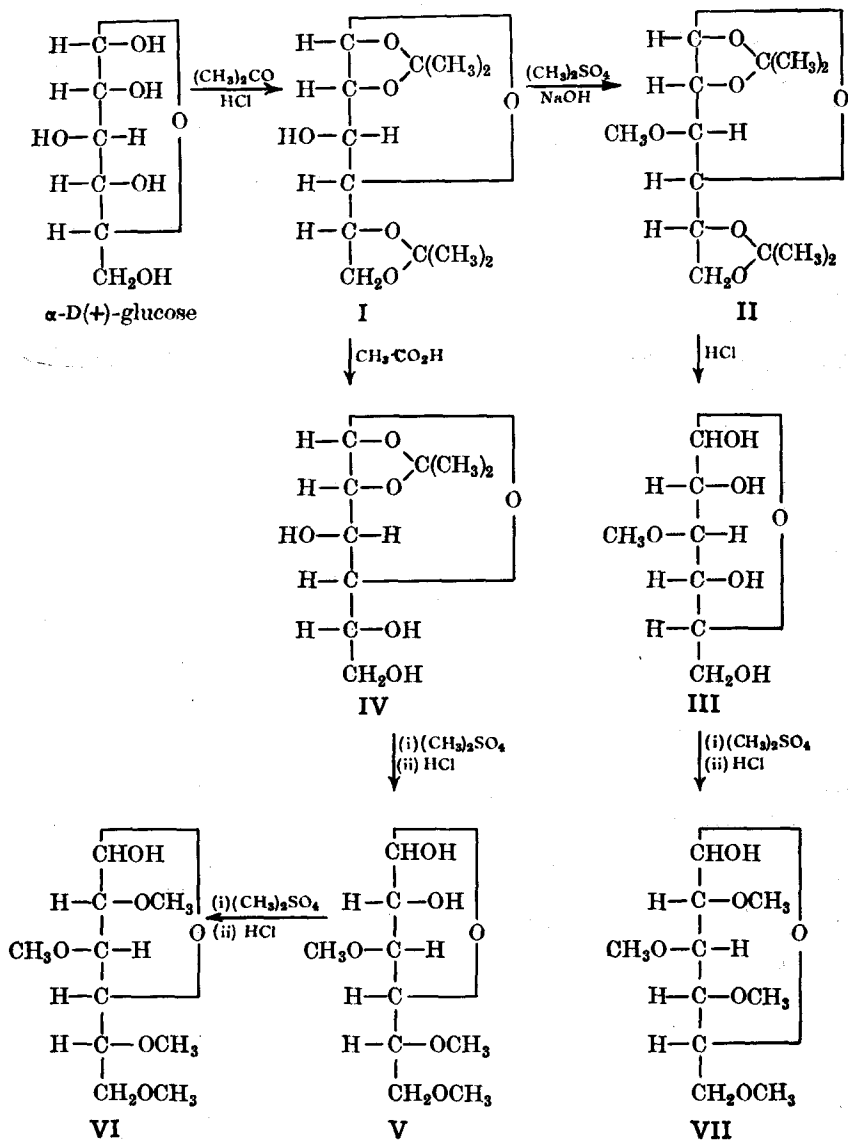

As a result of much experimental work (of the foregoing type), it has been found that acetone usually condenses with *cis*-hydroxyl groups on *adjacent* carbon atoms, the condensation occurring in such a way as to favour the formation of the di-*isopropylidene* derivative. For this to occur, the ring often changes size, *e.g.*, in  $\alpha$ -D-galactopyranose, VIII, the hydroxyl groups on C<sub>1</sub> and C<sub>2</sub> are in the *cis* position, as are also the hydroxyl groups on C<sub>3</sub> and C<sub>4</sub>. Thus galactose forms the 1:2-3:4-di-*O-isopropylidene*-D-galactopyranose, IX. On the other hand, in  $\alpha$ -D-glucopyranose, only the two hydroxyl groups on C<sub>1</sub> and C<sub>2</sub> are in the *cis* position, and thus, in order to form the di-*isopropylidene* derivative, the ring changes from pyranose to furanose, the latter producing 1:2-5:6-di-*O-isopropylidene*-D-glucofuranose (I). The mono-derivative is 1:2-*O-isopropylidene*-D-glucofuranose

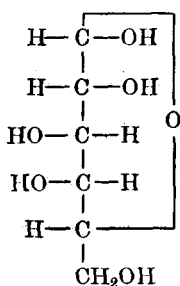

VIII

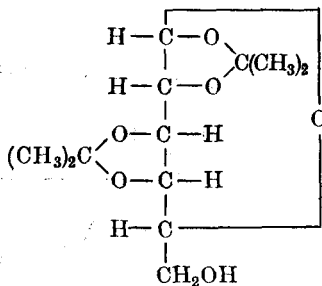

IX

(IV). Fructose can form *two* di-isopropylidene derivatives which both contain the pyranose ring.

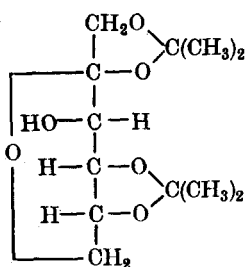

1:2-4:5-

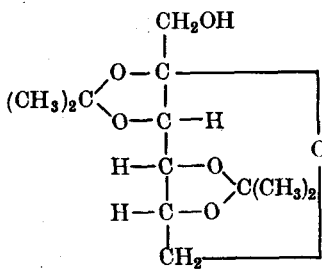

2:3-4:5-

§9. Other condensation products of the sugars. Not only does acetone condense with sugars, but so do other oxo compounds such as formaldehyde, acetaldehyde and benzaldehyde. Benzaldehyde condenses with two *cis* hydroxyl groups on *alternate* carbon atoms, *e.g.*, glucose forms 4:6-*O*-benzylidene-D-glucopyranose, I.

Triphenylmethyl chloride reacts with sugars to form triphenylmethyl ethers; these are usually known as *trityl* derivatives. Trityl ethers are

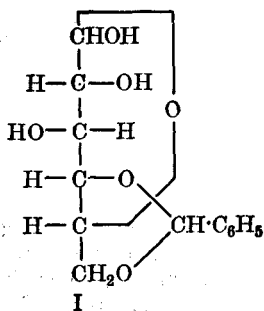

I

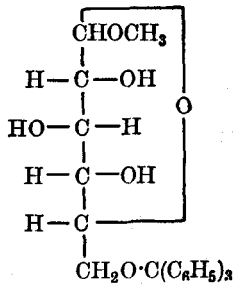

II

formed much faster with primary alcoholic groups than with secondary, *e.g.*, methyl glucopyranoside reacts with triphenylmethyl chloride in pyridine solution to form methyl 6-tritylglucopyranoside, II.

*p*-Toluenesulphonyl chloride (represented as TsCl in the following equations) reacts with sugars in the presence of pyridine to form *tosyl* esters. These esters usually produce **epoxy-sugars (anhydro sugars)** when hydrolysed with sodium methoxide in the cold, provided that there is a free



hydroxyl group on an adjacent carbon atom and that this hydroxyl and the tosyl group are *trans* to each other. This is an example of neighbouring hydroxyl group participation (§6c. III), and the mechanism is:

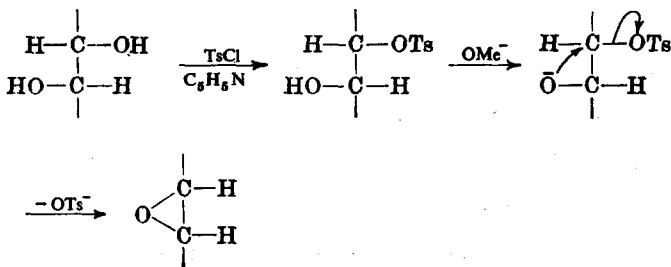

On hydrolysis with alkali, these anhydro sugars form a mixture of *two* sugars, inversion occurring at either carbon when the epoxide ring opens (see §5. IV).

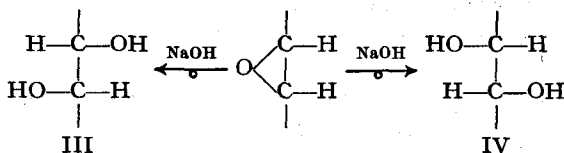

In III the configurations of the two carbon atoms are the same as in the original sugar, but in IV *both* configurations are inverted (to form a new sugar).

When the tosyl group is *trans* to two hydroxyl groups (on adjacent carbon atoms), *two* anhydro sugars are formed. At the same time, however, *larger* epoxide rings may be produced *without* inversion, e.g., Peat *et al.* (1938) treated 3-tosyl methyl  $\beta$ -glucoside (V) with sodium methoxide and obtained a mixture of 2 : 3-anhydroalloside (VI; with inversion), 3 : 4-anhydroalloside (VII; with inversion), and 3 : 6-anhydroglucoside (VIII; no inversion).

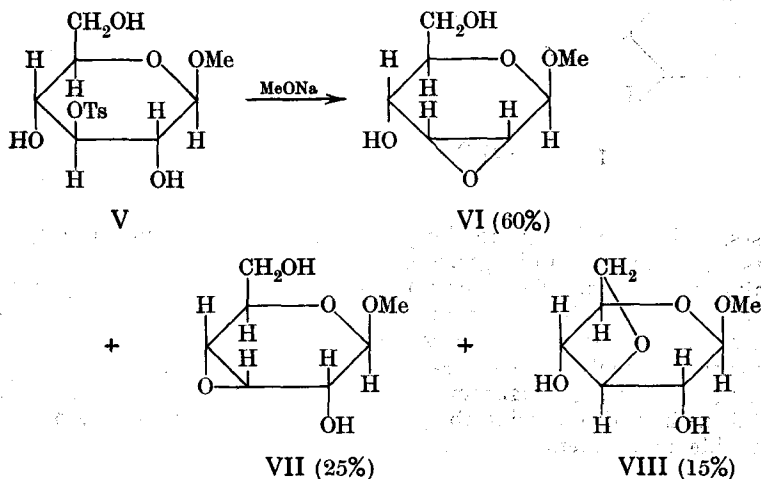

It is possible, however, by using suitable derivatives of a tosyl ester to obtain only one anhydro sugar, e.g., 2-benzoyl-3-tosyl 4 : 6-benzylidene

methyl  $\alpha$ -glucoside (IX), on treatment with sodium methoxide, forms 2 : 3-anhydro 4 : 6-benzylidene methyl  $\alpha$ -alloside (X).

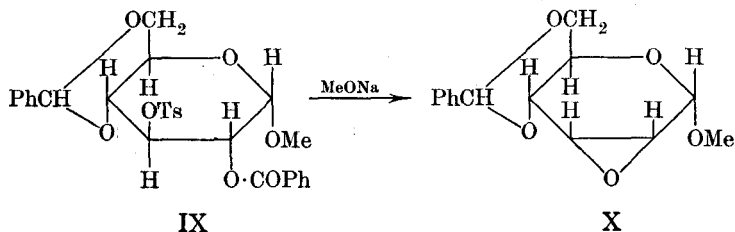

For the formation of the epoxide to proceed easily, it is necessary that the *trans* OH and Ts groups should be diaxial. In the majority of tosyl derivatives, however, both the tosyl group and the vicinal *trans*-hydroxyl group are equatorial (*cf.* §7h). Nevertheless, these tosyl derivatives are still easily converted into epoxides. This may be explained on the basis that the normal chair form (C1) readily changes into the reverse chair form (1C); consequently both groups are now axial and so epoxide formation proceeds readily (*cf.* §5b. IV).

**§10. Glycols and glycosamines and anhydro sugars.** Glycols are sugar derivatives which have a pyranose ring structure and a double bond between  $C_1$  and  $C_2$ , *e.g.*, D-glucal is I. Glycols may be prepared by reducing acetobromo compounds (see §24) with zinc dust and acetic acid, *e.g.*, D-glucal from tetra-*O*-acetyl-D-glucopyranosyl bromide, II, followed by hydrolysis of the acetyl groups.

**Glycosamines** are amino-sugars in which a hydroxyl group has been replaced by an amino-group. All naturally occurring amino-sugars are

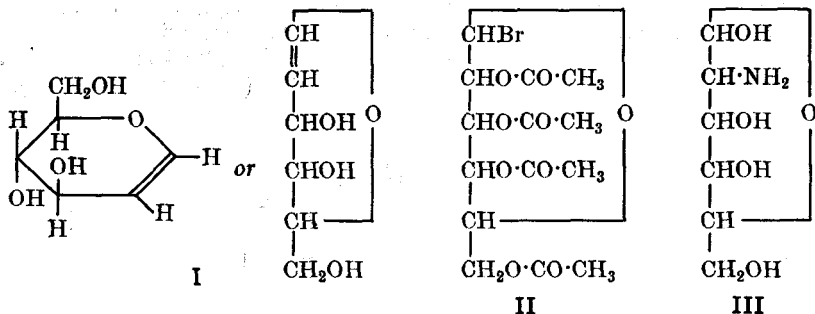

hexoses, and the amino-group always occurs on  $C_2$ , *e.g.*, glucosamine, which occurs in chitin, is 2-aminoglucose, III (see also §23).

**Anhydro sugars.** These may be regarded as being derived from monosaccharides by the elimination of a molecule of water to form an epoxide. The size of the oxiran ring varies from 1 : 2- to 1 : 6-. The 1 : 2-anhydro sugars are commonly known as  $\alpha$ -glycosans, and may be prepared in various ways, *e.g.*, by heating a sugar under reduced pressure (Pictet *et al.*, 1920). A general method of producing the ethylene oxide series is by the hydrolysis of suitable tosyl esters (see §9).

**§11. Vitamin C or L-ascorbic acid.** Ascorbic acid is very closely related to the monosaccharides, and so is conveniently dealt with here. Hawkins (1593) found that oranges and lemons were effective for treating

scurvy, a disease particularly prevalent among seamen. The first significant step in elucidating the nature of the compound, the absence of which from the diet caused scurvy, was that of Holst and Frölich (1907), who produced experimental scurvy in guinea-pigs. Then Szent-Györgi (1928) isolated a crystalline substance from various sources, *e.g.*, cabbages, paprika, etc., and found that it had antiscorbutic properties. This compound was originally called *hexuronic acid*, and later was shown to be identical with vitamin C, m.p. 192°,  $[\alpha]_D$  of +24°.

The structure of vitamin C was elucidated by Haworth, Hirst and their co-workers (1932, 1933). The molecular formula was shown to be  $C_6H_8O_6$ , and since the compound formed a monosodium and monopotassium salt, it was thought that there was a carboxyl group present. Vitamin C behaves as an unsaturated compound and as a strong reducing agent; it also forms a phenylhydrazone and gives a violet colour with ferric chloride. All this suggests that a keto-enol system is present, *i.e.*,

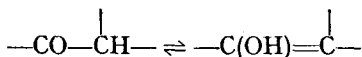

The presence of an aldehyde group was excluded by the fact that vitamin C does not give the Schiff reaction. Now, when boiled with hydrochloric acid, ascorbic acid gives a quantitative yield of furfuraldehyde:

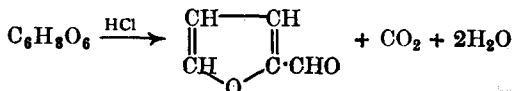

This reaction suggests that ascorbic acid contains at least five carbon atoms in a straight chain, and also that there are a number of hydroxyl groups present (*cf.* the pentoses). Aqueous iodine solution oxidises ascorbic acid to dehydroascorbic acid, two atoms of iodine being used in the process and two molecules of hydrogen iodide are produced; the net result is the removal of two hydrogen atoms from ascorbic acid. Dehydroascorbic acid is neutral and behaves as the lactone of a monobasic hydroxy-acid; and on reduction with hydrogen sulphide, dehydroascorbic acid is reconverted into ascorbic acid. Since this oxidation-reduction process may be carried out with "mild" reagents, it leads to the suggestion that since the oxidation product, dehydroascorbic acid, is a lactone, then ascorbic acid itself is a lactone and *not* an acid as suggested previously. Since, however, ascorbic acid can form salts, this property must still be accounted for. One reasonable possibility is that the salt-forming property is due to the presence of an *enol* group, the presence of which has already been indicated. Thus all the preceding reactions can be explained by the presence of an  $\alpha$ -hydroxyketone grouping in ascorbic acid:

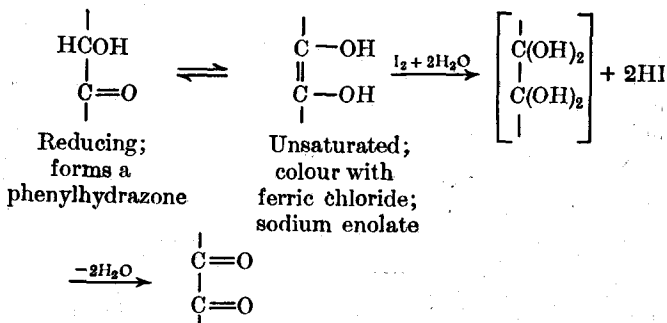

The final result is the removal of two hydrogen atoms to form dehydroascorbic acid.

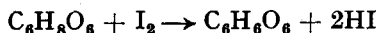

Although all these reactions may appear to be speculative, they are known to occur with dihydroxymaleic acid; hence by analogy with this compound, the explanation offered for the reactions of ascorbic acid is very strongly supported.

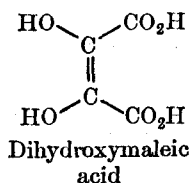

When dehydroascorbic acid is oxidised with sodium hypiodite, oxalic and L-threonic acids are produced in quantitative yields (Hirst, 1933). L-Threonic acid, IV, was identified by methylation and then conversion into the crystalline amide; this compound was shown to be identical with tri-O-methyl-L-threonamide (obtained from L-threose). Further evidence for the nature of product IV is given by the fact that on oxidation with nitric acid it gives D(+)-tartaric acid. The formation of oxalic and L-threonic acids suggests that dehydroascorbic acid is III, the lactone of 2:3-diketo-L-gulonic acid. Hence, if we assume that I is the structure of ascorbic acid, the foregoing reactions may be formulated as follows, dehydroascorbic acid being formed *via* II.

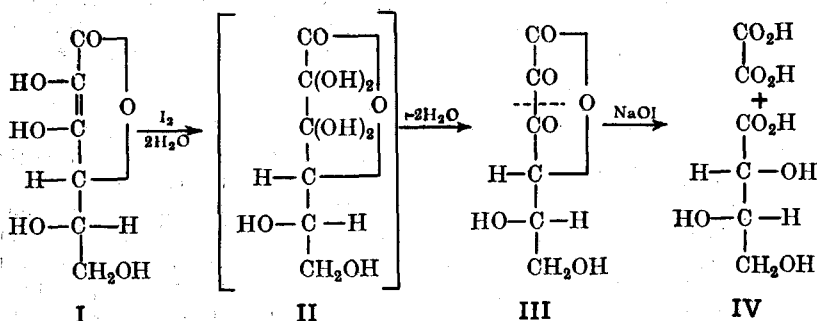

The ring in ascorbic acid has been assumed to be five- and not six-membered, because the lactone (*i.e.*, ascorbic acid) is stable towards alkali (*cf.* §7c). In actual fact, however, the same final products would also have been obtained had the ring been six-membered. It must therefore be admitted that the weakness of the above proof of structure lies in the evidence used for ascertaining the size of the ring. Structure I, however, has been amply confirmed by other analytical evidence. Diazomethane converts ascorbic acid into dimethylascorbic acid (V); these two methoxyl groups are most likely on C<sub>2</sub> and C<sub>3</sub>, since diazomethane readily methylates acidic (in this case, enolic) hydroxyl groups. This dimethyl derivative is neutral, and dissolves in aqueous sodium hydroxide to form a sodium salt without the elimination of a methyl group; thus there cannot be a carbomethoxyl group present, and so it is most likely that two enolic hydroxyl groups are present (Hirst, 1933). Furthermore, the formation of the sodium salt from the neutral compound suggests the opening of a lactone ring (the two enolic

groups are now methylated and so cannot form a sodium salt). The similarity in structure between ascorbic acid and its dimethyl derivative is shown by the fact that the absorption spectra of both are similar. When this dimethyl derivative is methylated with methyl iodide in the presence of dry silver oxide (Purdie method; see §7), two further methyl groups are introduced (VI), and since all four methyl groups behave as methyl ethers, it therefore follows that two alcoholic groups are present in dimethylascorbic acid. Ozonolysis of this tetramethyl compound produces *one* neutral substance containing the *same* number of carbon atoms as its precursor. Since ozonolysis of a carbon-carbon double bond results in scission of that bond, there must be a ring system present in the tetramethyl compound to hold together the two fragments (VII). This ozonised product, on hydrolysis with barium hydroxide, gives oxalic acid and dimethyl-L-threonic acid (VIII). These products contain three carboxyl groups in all, and since ozonolysis of a double bond produces only two, the third carboxyl group must have already been present *as a lactone* in order that ascorbic acid should behave as a neutral compound.

The key to the size of the ring in ascorbic acid is the structure of this dimethyl-L-threonic acid, the nature of which has been ascertained as follows. On methylation, followed by conversion to the amide, dimethyl-L-threonic acid gives trimethyl-L-threonamide. Thus this dimethyl compound, which was unknown when isolated, is a dimethyl-L-threonic acid; but where are the two methoxyl groups? Their positions were ascertained by means of the **Weerman test**. This test is used for showing the presence of a *free* hydroxyl group in the  $\alpha$ -position to an amide group, i.e., in an  $\alpha$ -hydroxyamide. Treatment of a methylated hydroxy-amide with alkaline sodium

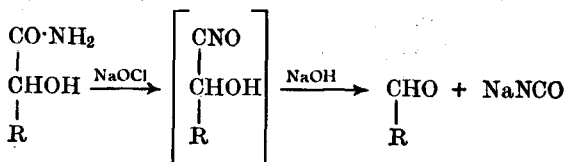

hypochlorite gives an aldehyde and *sodium cyanate* if there is a *free* hydroxyl group on the  $\alpha$ -carbon atom. If there is no free hydroxyl group on the  $\alpha$ -carbon atom, i.e., this atom is attached to a methoxyl group, then treatment with alkaline sodium hypochlorite produces an aldehyde, methanol, ammonia and carbon dioxide.

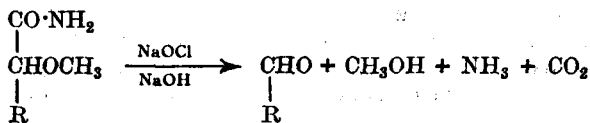

The dimethylthreonic acid obtained from the ozonised product was converted into the amide (IX), and this, when subjected to the Weerman test, gave sodium cyanate as one of the products. Thus this dimethylthreonic acid contains a free  $\alpha$ -hydroxyl group, and consequently must be 3:4-di-O-methyl-L-threonic acid, VIII. Therefore the lactone ring in ascorbic acid must be  $\gamma$ -, since a  $\delta$ -lactone could not have given VIII (actually, 2:4-di-O-methyl-L-threonic acid would have been obtained). The amide IX was also obtained, together with oxamide, by the action of ammonia in methanol on the ozonised product, VII. All the foregoing facts can be represented by the following equations:

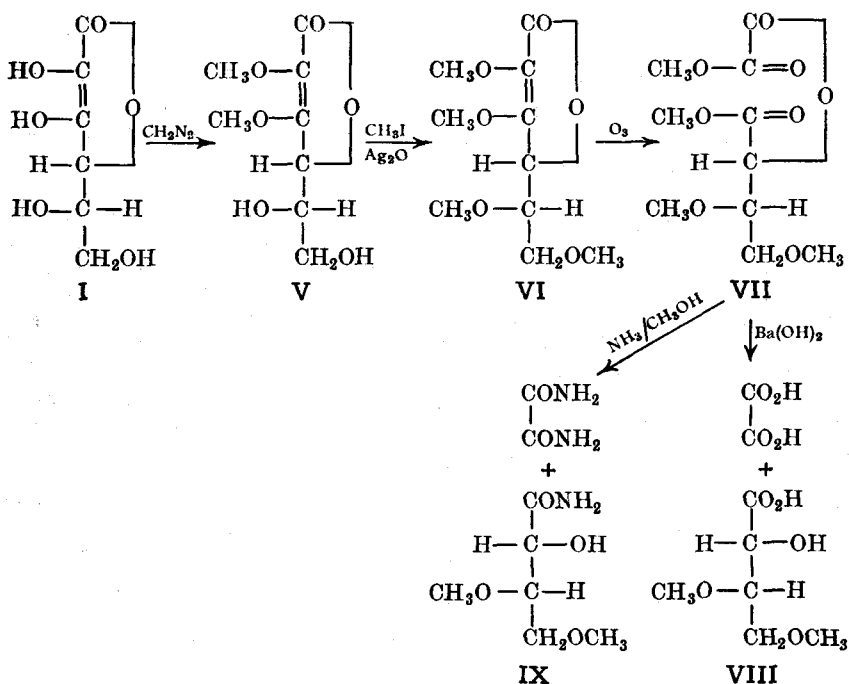

An interesting point about ascorbic acid is that it is *not* reduced by lithium aluminium hydride (Petuely *et al.*, 1952). Thus ascorbic acid does not contain a "normal" carbonyl group. It has now been shown that all **reduc-**

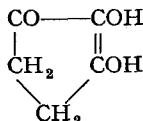

reductic acid

**tones** are not reduced by lithium aluminium hydride. Reductones are compounds which contain the ene- $\alpha$ -diol- $\alpha$ -carbonyl grouping,

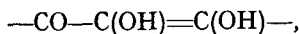

and examples of reductones are ascorbic and reductic acids.

**Synthesis of ascorbic acid.** Many methods of synthesising ascorbic acid are now available, *e.g.*, that of Haworth and Hirst (1933), L-Lyxose, X, was converted into L(-)-xylosone, XI (treatment with phenylhydrazine and then hydrolysis of the osazone with hydrochloric acid), and XI, on treat

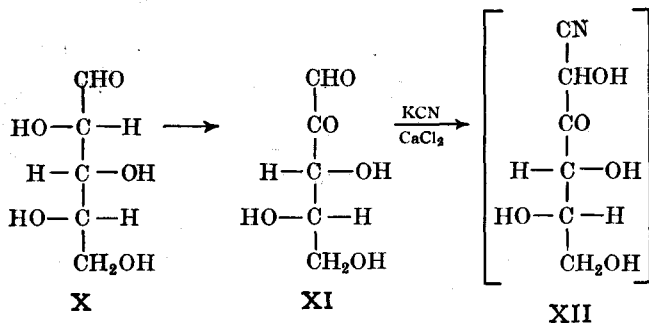

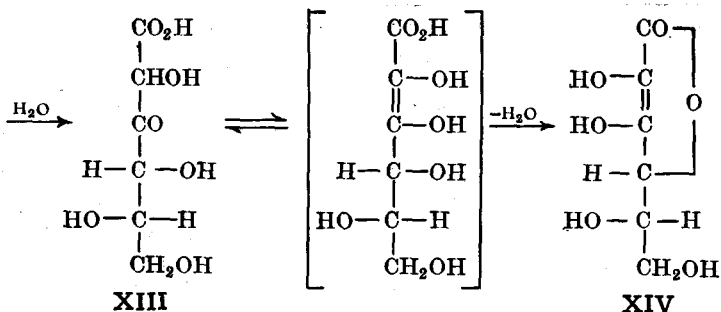

ment in an atmosphere of nitrogen with aqueous potassium cyanide containing calcium chloride, gave the  $\beta$ -keto-cyanide XII, which hydrolyses spontaneously into *pseudo*-L-ascorbic acid, XIII. This, on heating for 26 hours with 8 per cent. hydrochloric acid at 45-50°, gave a quantitative yield of L-(+)-ascorbic acid, XIV.

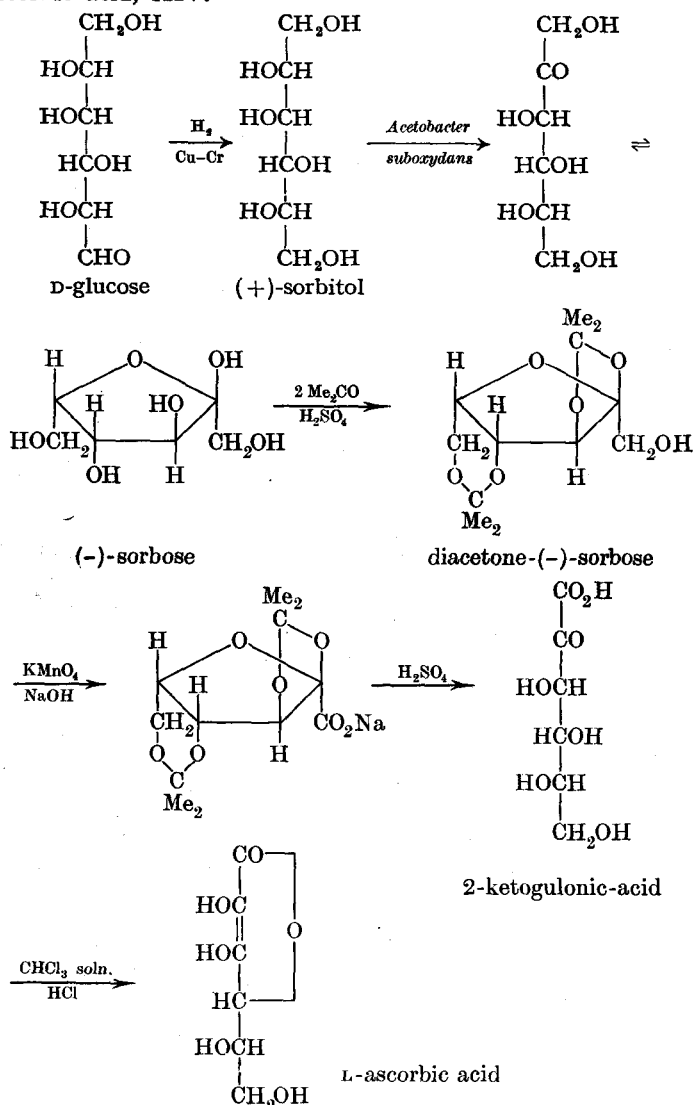

Ascorbic acid is now synthesised commercially by several methods, *e.g.*, D-glucose is catalytically hydrogenated to (+)-sorbitol which is then converted into (–)-sorbitol by microbiological oxidation (using *Acetobacter suboxydans* or *Acetobacter xylinum*). (–)-Sorbitol can be oxidised directly to 2-keto-(–)-gulonic acid with nitric acid, but the yield is less than when the oxidation is carried out as shown above. Nitric acid oxidises other alcohol groups besides the first, but by protecting these by means of 2 : 3-4 : 6-di-isopropylidene formation (§8), the yield of the gulonic acid is higher. The gulonic acid is then dissolved in mixed solvents (of which chloroform is the main constituent) and hydrogen chloride passed in. The product, L-ascorbic acid, is then finally purified by charcoaling (see previous page).

**Biosynthesis of ascorbic acid** (see also §32a. VIII). Horowitz *et al.* (1952) and Burns *et al.* (1956) have shown that rat and plant tissues can convert D-glucose into ascorbic acid. A very interesting observation is that glucose labelled at C<sub>1</sub> (with <sup>14</sup>C) produces the vitamin labelled at C<sub>6</sub>. In this way, the glucose molecule is "turned upside down" to form the glucose derivative (*cf.* the stereochemistry of glucose and gulose, §1).

## DISACCHARIDES

**§12. Introduction.** The common disaccharides are the dihexoses, and these have the molecular formula C<sub>12</sub>H<sub>22</sub>O<sub>11</sub>. Just as methanol forms methyl glycosides with the monosaccharides, so can other hydroxy compounds also form glycosides. The monosaccharides are themselves hydroxy compounds, and so can unite with other monosaccharide molecules to form glycosidic links. Study of the disaccharides (of the dihexose type) has shown that three types of combination occur in the natural compounds:

- (i) The two monosaccharide molecules are linked through their reducing groups, *e.g.*, sucrose.
- (ii) C<sub>1</sub> of one molecule is linked to C<sub>4</sub> of the other, *e.g.*, maltose.
- (iii) C<sub>1</sub> of one molecule is linked to C<sub>6</sub> of the other, *e.g.*, melibiose.

Since the glycosidic link may be  $\alpha$  or  $\beta$ , then different stereoisomeric forms become possible for a given pair of hexoses. In group (i), there are four forms possible theoretically:  $\alpha_1$ - $\alpha_2$ ,  $\alpha_1$ - $\beta_2$ ,  $\beta_1$ - $\alpha_2$  and  $\beta_1$ - $\beta_2$ . In groups (ii) and (iii), the reducing group of the second molecule is free, and so in these two cases there are only two possibilities:  $\alpha_1$ - and  $\beta_1$ -. In group (i), since *both* reducing groups are involved in glycoside formation, the resultant disaccharide will be non-reducing. In groups (ii) and (iii), since *one* reducing group is free, the resultant disaccharide will be reducing, and can exist in two forms, the  $\alpha$ - and  $\beta$ -.

**General procedure.** The disaccharide is first hydrolysed with dilute acids, and the two monosaccharide molecules then identified. One of the earlier methods of separating sugars in a sugar mixture was by fractional crystallisation; the separation and identification is now carried out by means of partition chromatography. When the constituents have been identified, the next problem is to ascertain which hydroxyl group of the molecule acting as the alcohol (*i.e.*, the aglycon; §3) is involved in forming the glycosidic link. This is done by completely methylating the disaccharide; the methyl glycoside (of a reducing sugar) cannot be prepared by means of methanol and hydrochloric acid, since this will lead to hydrolysis of the disaccharide. Purdie's method cannot be used for reducing disaccharides since these will be oxidised (see §7). The only satisfactory way is Haworth's method, and to ensure complete methylation, this may be *followed* by the Purdie method. The methylated disaccharides are then hydrolysed, and the methylated monosaccharides so obtained are investigated by the oxidation



methods described previously (see §§7a, 7b, 7e). Reducing disaccharides are also oxidised to the corresponding bionic acid, this is then fully methylated, hydrolysed, and the methylated monosaccharide molecules examined. By this means the hydroxyl group involved in the glycosidic link and the size of the oxide ring are ascertained.

The final problem is to decide whether the glycosidic link is  $\alpha$  or  $\beta$ . This is done by means of enzymes, maltase hydrolysing  $\alpha$ -glycosides and emulsin  $\beta$ -glycosides (*cf.* §3). In non-reducing sugars, the problem is far more difficult since the links  $\alpha_1$ - $\alpha_2$ ,  $\alpha_1$ - $\beta_2$ ,  $\beta_1$ - $\alpha_2$  would all be hydrolysed by maltase. Consideration of the optical rotations has given information on the nature of the link (*cf.* §6). Finally, a number of disaccharides have been synthesised, the acetobromo-sugars being the best starting materials (see §24).

**§13. Sucrose.** Sucrose has been shown to be  $\alpha$ -D-glucopyranosyl- $\beta$ -D-fructofuranoside. Sucrose is hydrolysed by dilute acids or by the enzyme invertase to an equimolecular mixture of D(+)-glucose and D(-)-fructose. Methylation of sucrose (Haworth method) gives octa-O-methylsucrose and this, on hydrolysis with dilute hydrochloric acid, gives 2 : 3 : 4 : 6-tetra-O-methyl-D-glucose and 1 : 3 : 4 : 6-tetra-O-methyl-D-fructose. The structures of these compounds were determined by the oxidation methods previously described (see §§7a, 7e). Thus glucose is present in the pyranose form, and fructose as the furanose.

Since sucrose is a non-reducing sugar, both glucose and fructose must be linked *via* their respective reducing groups. The stereochemical nature of the glycosidic link may be any one of the four possibilities discussed (see §12), but the evidence indicates that it is  $\alpha$ -glucose linked to  $\beta$ -fructose. Maltase hydrolyses sucrose; therefore an  $\alpha$ -link is present. Furthermore, since the mutarotation of the glucose produced is in a downward direction, it therefore follows that  $\alpha$ -glucose is liberated at first. The mutarotation of fructose is too rapid to be followed experimentally, and hence the nature of the link in this component remains to be determined. There is, however, an enzyme which hydrolyses methyl  $\beta$ -fructofuranosides, and it has been found that it also hydrolyses sucrose. This suggests that fructose is present in sucrose in the  $\beta$ -form, and is supported by calculations of the optical rotation of the fructose component. The following structure for sucrose accounts for all of the above facts:

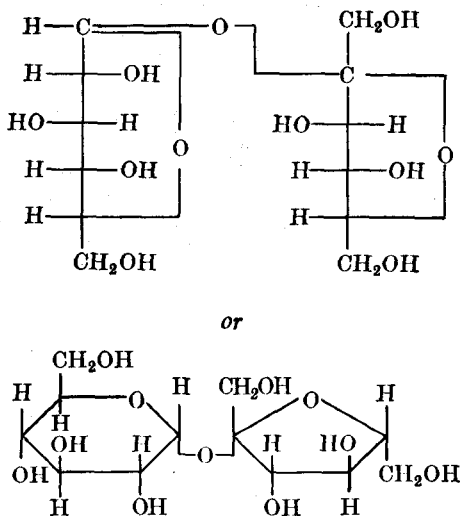

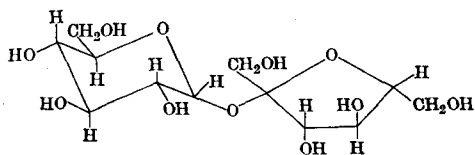

Oxidation of sucrose with periodic acid confirms this structure (but not the nature of the glycosidic link). Three molecules of periodic acid are consumed, and one molecule of formic acid is produced. Subsequent oxidation with bromine water, followed by hydrolysis, gives glyoxylic, glyceric and hydroxypyruvic acids (Fleury *et al.*, 1942).

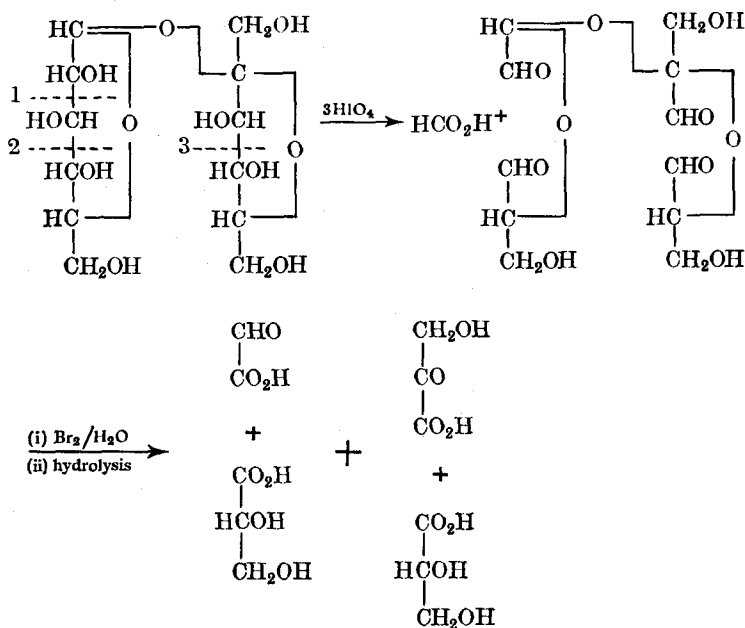

Beever *et al.* (1947) examined sucrose sodium bromide dihydrate by X-ray analysis, and confirmed the stereochemical configuration found chemically, and also showed that the fructose ring is five-membered.

Sucrose has now been synthesised by Lemieux *et al.* (1953, 1956). Brigl (1921) prepared the sugar epoxide, 3 : 4 : 6-tri-*O*-acetyl-1 : 2-anhydro- $\alpha$ -D-glucose, II, from tetra-*O*-acetyl- $\beta$ -D-glucose, I (*cf.* §9; see also §24).

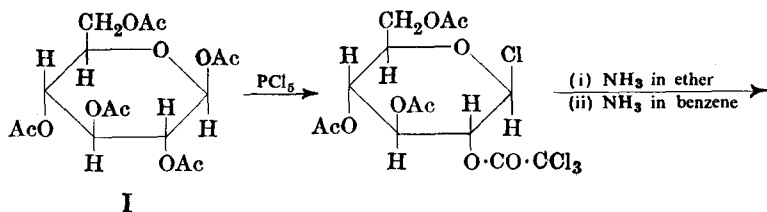

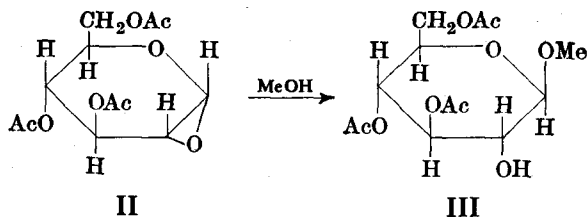

Brigl also showed that II reacted with methanol to give methyl  $\beta$ -D-glucopyranoside triacetate, III, whereas with phenol, the  $\alpha$ -glucopyranoside was the main product. Other workers showed that secondary alcohols gave  $\alpha, \beta$ -mixtures. Lemieux was therefore led to believe that fructofuranose, a hindered secondary alcohol, would react with anhydroglucopyranose to form an  $\alpha$ -glucose linkage. 1:2-Anhydro- $\alpha$ -D-glucopyranose triacetate and 1:3:4:6-tetra-*O*-acetyl-D-fructofuranose were heated in a sealed tube at  $100^\circ$  for 104 hours. The product, sucrose octa-acetate, on deacetylation, gave sucrose (yield about 5 per cent.). According to Lemieux, the reaction proceeds as follows:

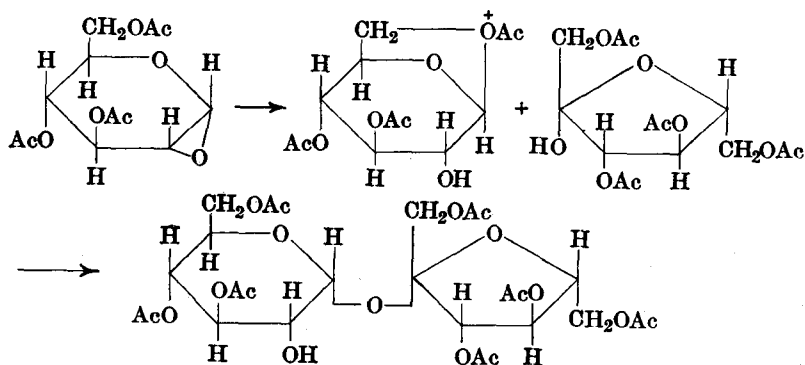

The  $\text{CH}_2\text{OAc}$  group at position 6 in the glucopyranose molecule enters into neighbouring group participation in the opening of the oxide ring, and consequently shields this side from attack. Thus the fructofuranose molecule is forced to attack from the other side and this produces the desired  $\alpha$ -glucopyranose linkage.

One other point that is of interest is the "inversion" of sucrose on hydrolysis. Hydrolysis of sucrose gives first of all  $\alpha$ -D(+)-glucopyranose and  $\beta$ -D(+)-fructofuranose (this is believed to be dextrorotatory), but the latter is unstable and immediately changes into the stable form, D(-)-fructopyranose (the rotation of (-)-fructose is much greater than that of (+)-glucose).

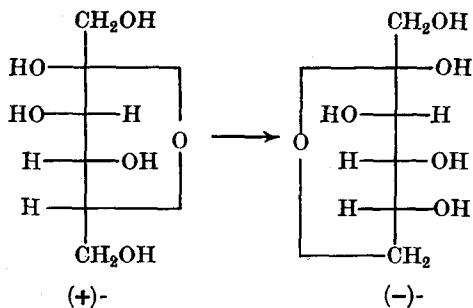

§14. **Trehalose.** This is believed to be  $\alpha$ -D-glucopyranosyl- $\alpha$ -D-glucopyranoside. It is a non-reducing sugar which occurs in yeasts and fungi. It is hydrolysed by hydrochloric acid to two molecules of D-glucose; methylation of trehalose gives octa-O-methyltrehalose which, on hydrolysis, produces two molecules of 2 : 3 : 4 : 6-tetra-O-methyl-D-glucose (see §7a). The nature of the glycosidic link is uncertain, but there is some evidence to show that it is  $\alpha$  :  $\alpha$ , e.g., the high positive rotation. Thus trehalose may be written.

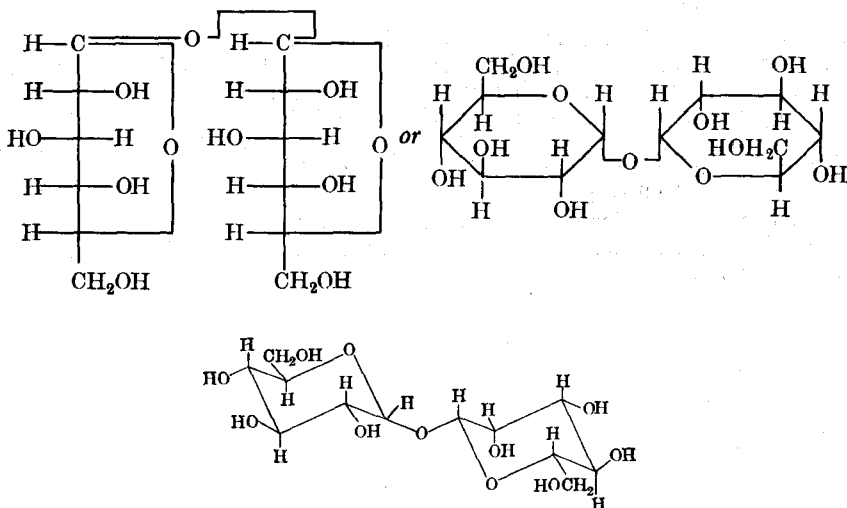

§15. **Maltose.** This is 4-O- $\alpha$ -D-glucopyranosyl-D-glucopyranose. Maltose is hydrolysed by dilute acids to two molecules of D-glucose; it is a reducing sugar, undergoes mutarotation, and forms an osazone. Thus there is one free reducing group present, and since maltose is hydrolysed by maltase, the glycosidic link of the non-reducing half of the molecule is therefore  $\alpha$ -. Complete methylation of maltose gives an octamethyl derivative which is non-reducing, and this, on hydrolysis with very dilute cold hydrochloric acid, is converted into heptamethylmaltose, which has reducing properties. Thus the original octamethyl derivative must be methyl hepta-O-methyl-D-maltoside; this is further evidence that only *one* free reducing group is present in maltose. Hydrolysis of hepta-O-methylmaltose with moderately concentrated hydrochloric acid produces 2 : 3 : 6-tri-O-methyl-D-glucose and 2 : 3 : 4 : 6-tetra-O-methyl-D-glucose. The structure of the latter is known (see §7a), but that of the former was elucidated as follows. Analysis of the compound showed that it was a trimethyl derivative, and since it formed a phenylhydrazone but not an osazone, C<sub>2</sub> must therefore be attached to a methoxyl group. On further methylation, this trimethylglucose gave 2 : 3 : 4 : 6-tetra-O-methyl-D-glucose, and so the trimethyl compound must be one of the following: 2 : 3 : 4-, 2 : 3 : 6- or 2 : 4 : 6-tri-O-methyl-D-glucose. Now, on careful oxidation with nitric acid, the trimethylglucose forms a dimethylsaccharic acid. This acid contains two terminal carboxyl groups; one has been derived from the free "aldehyde" group, and the other by oxidation at C<sub>6</sub>, and since in its formation one methyl group is lost, this dimethylsaccharic acid must have been derived from a trimethylglucose having a methoxyl group at C<sub>6</sub>. Thus the trimethylglucose must be either 2 : 3 : 6- or 2 : 4 : 6-tri-O-methyl-D-glucose. On further oxidation, the dimethylsaccharic acid forms dimethyl-D-tartaric acid; this can only arise from a precursor with two methoxyl groups on *adjacent* carbon atoms, and so it

follows that the trimethylglucose must be 2:3:6-tri-*O*-methyl-D-glucose. This is confirmed by the fact that the other two possible compounds, *viz.*, 2:3:4- and 2:4:6-tri-*O*-methyl-D-glucose, have been synthesised, and were shown to be different from the trimethylglucose obtained from maltose. The foregoing reactions may thus be written:

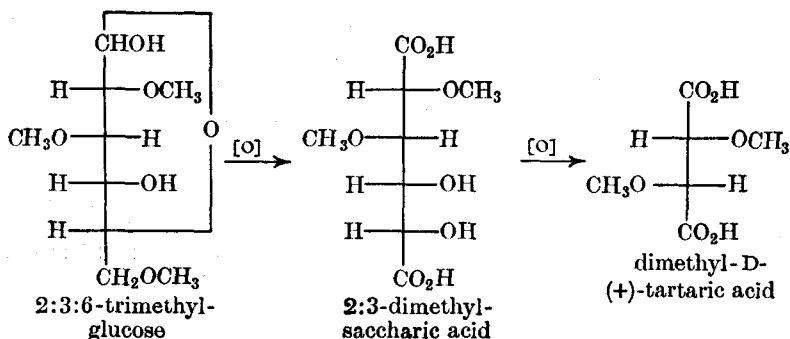

From this it can be seen that structure I for maltose satisfies all the above facts. This structure, however, is not the only one that satisfies all the facts. The structure of the non-reducing half is certain, but that of the reducing half need not necessarily be pyranose as shown in I, since a furanose structure, II, would also give 2:3:6-tri-*O*-methyl-D-glucose. To decide whether C<sub>4</sub> (as in I) or C<sub>5</sub> (as in II) was involved in the glycosidic link,

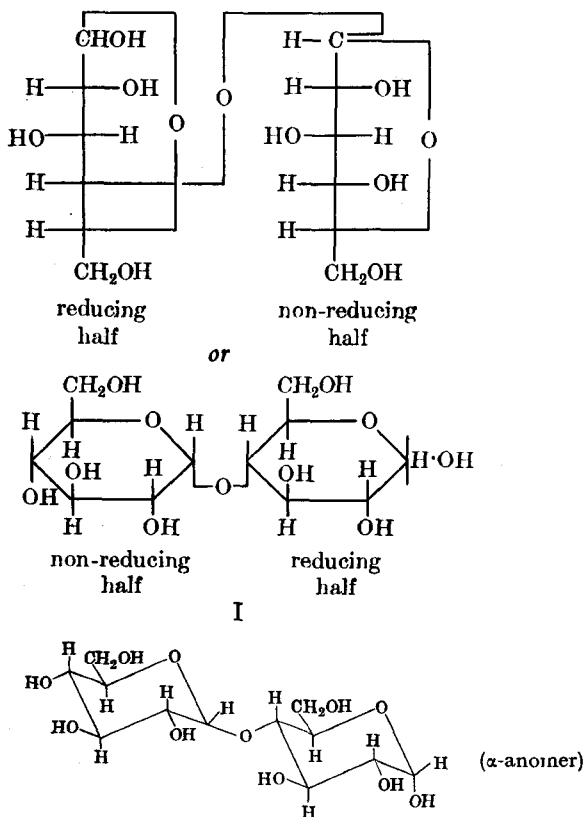

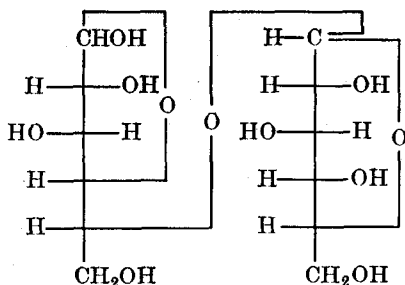

II

Haworth *et al.* (1926) oxidised maltose with bromine water to maltobionic acid, III, and this, on methylation, gave the methyl ester of octamethyl-maltobionic acid, IV, which, on vigorous hydrolysis, gave 2 : 3 : 5 : 6-tetra-*O*-methyl-D-gluconic acid, V (as lactone), and 2 : 3 : 4 : 6-tetra-*O*-methyl-D-

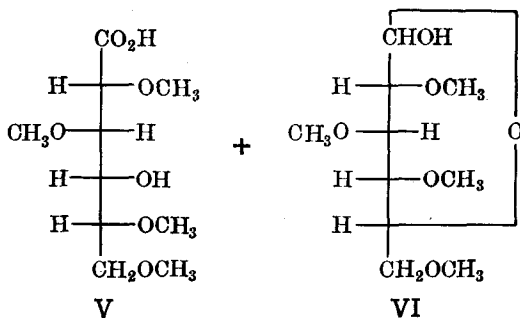
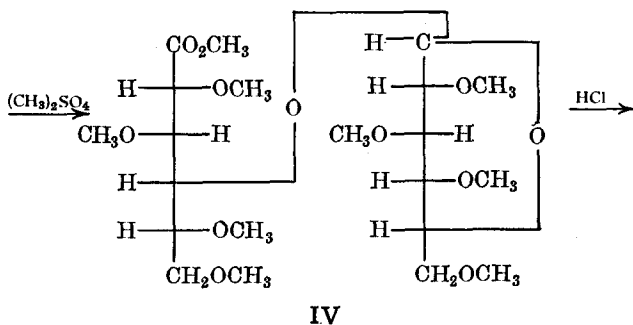
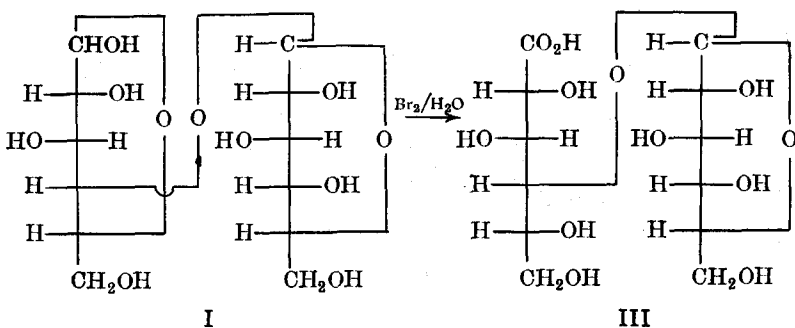

glucose, VI. V can be obtained only if maltose has structure I; structure II would have given 2 : 3 : 4 : 6-tetra-*O*-methyl-D-gluconic acid. Thus maltose is I and not II. Confirmation of the  $\alpha$ -glycosidic linkage is afforded by the agreement of the specific rotation of maltose with that calculated for structure I, and further evidence for the linkage at  $C_4$  is as follows. Since maltose is a reducing sugar,  $C_1$  (of the reducing half) is free, and since maltose forms an osazone,  $C_2$  is also free, *i.e.*, not combined with an alkoxyl group. Zemplen (1927) degraded maltose by one carbon atom (see Vol. I), and obtained a compound which still formed an osazone; therefore  $C_3$  is free. On further degrading by one carbon atom, a compound was obtained which did not form an osazone; therefore  $C_4$  in maltose is not free (see also §7g).

Maltose has been synthesised by the action of yeast on D-glucose (Pringsheim *et al.*, 1924), and maltose octa-acetate has been synthesised by heating a mixture of equimolecular amounts of  $\alpha$ - and  $\beta$ -D-glucose at 160°, and then acetylating the product (Pictet *et al.*, 1927).

**§16. Cellobiose (4-*O*- $\beta$ -D-glucopyranosyl-D-glucopyranose).** Cellobiose is hydrolysed by dilute acids to two molecules of D(+)-glucose; since this hydrolysis is also effected by emulsin, the glycosidic link must be  $\beta$ . Cellobiose is a reducing sugar, and so one reducing group is free. Methylation, followed by hydrolysis, gives 2 : 3 : 6-trimethyl-D-glucose and 2 : 3 : 4 : 6-tetramethyl-D-glucose (these are the same products obtained from maltose, §15). Oxidation with bromine water converts cellobiose into cellobionic acid, and this, on methylation followed by hydrolysis, gives 2 : 3 : 5 : 6-tetramethylgluconic acid and 2 : 3 : 4 : 6-tetramethylglucose (again the same products as for maltose). Thus cellobiose and maltose differ only in that the former has a  $\beta$ -glycosidic link, whereas the latter has an  $\alpha$ . Thus cellobiose is ( $\alpha$ -form):

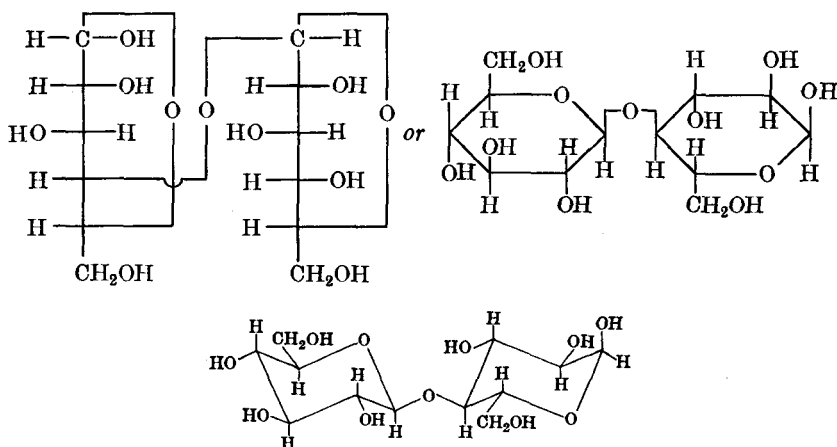

Degradation experiments confirm the  $C_4$  linkage (see also §7g), and the structure has also been confirmed by synthesis (*e.g.*, Stacey, 1946).

**§17. Lactose (4-*O*- $\beta$ -D-galactopyranosyl-D-glucopyranose).** Lactose is a reducing sugar, and is hydrolysed by dilute acids to one molecule of D(+)-glucose and one molecule of D(+)-galactose. Since lactose is hydrolysed by lactase (which has been shown to be identical with the  $\beta$ -glycosidase in emulsin), the two monosaccharide molecules are linked by a  $\beta$ -glycosidic link. The evidence, given so far, does not indicate which molecule is the reducing half. On methylation, lactose forms methyl heptamethyl-lactoside, and this, on vigorous hydrolysis, gives 2 : 3 : 6-tri-*O*-methyl-D-glucose

(see §15) and 2 : 3 : 4 : 6-tetra-*O*-methyl-D-galactose; thus glucose is the reducing half. Oxidation with bromine water converts lactose into lactobionic acid, and this, on methylation followed by hydrolysis, gives 2 : 3 : 5 : 6-tetra-*O*-methyl-D-gluconic acid and 2 : 3 : 4 : 6-tetra-*O*-methyl-D-galactose. Lactose is therefore ( $\beta$ -form) [see also §7g]:

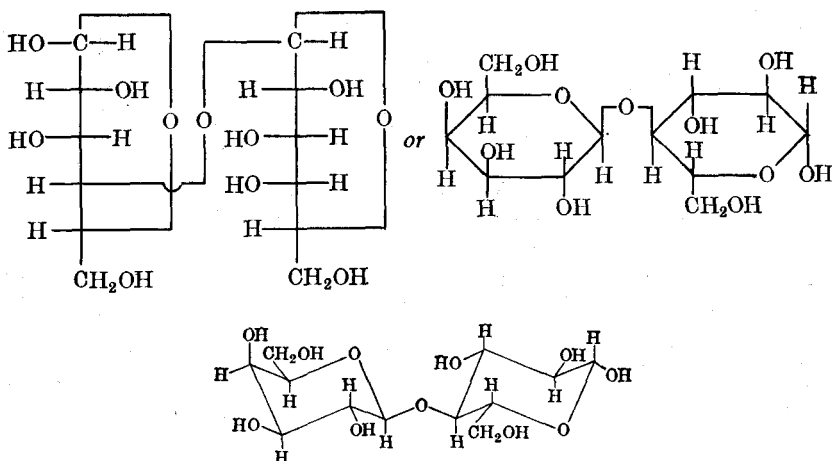

§18. **Melibiose** (6-*O*- $\alpha$ -D-galactopyranosyl-D-glucopyranose). This disaccharide is obtained from the trisaccharide, raffinose (§20); it is a reducing

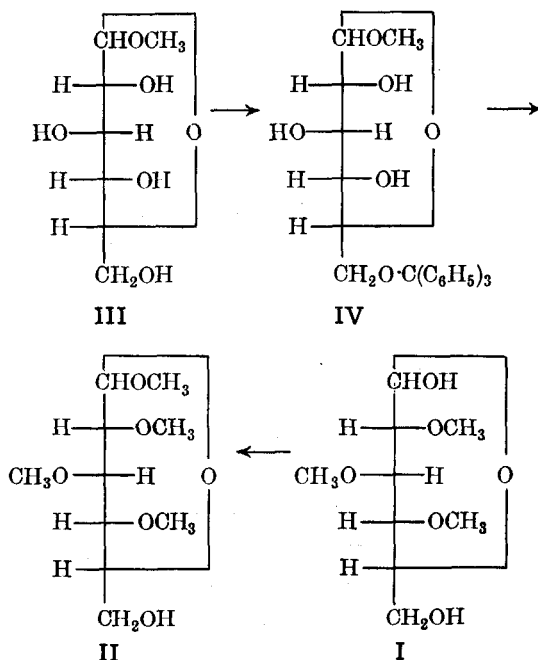

sugar, forms an osazone, and undergoes mutarotation. When hydrolysed by dilute acids, melibiose gives D-glucose and D-galactose. Methylation converts melibiose into methyl heptamethylmelibioside, and this, on hydrolysis, forms 2 : 3 : 4-trimethyl-D-glucose and 2 : 3 : 4 : 6-tetramethyl-D-galac-



tose. The structure of the former has been established as follows. The trimethylglucose, I, readily forms a crystalline methyl trimethylglucoside, II. Now methyl glucopyranoside, III, can be converted into the 6-trityl derivative, IV (see §9), and this, on methylation followed by removal of the trityl group, gives II. Thus II must be methyl 2 : 3 : 4-tri-*O*-methyl-*D*-glucopyranoside, and consequently I is 2 : 3 : 4-tri-*O*-methyl-*D*-glucose. From the foregoing facts, it can be seen that galactose is the non-reducing half of melibiose, and that its reducing group is linked to C<sub>6</sub> of glucose, the reducing half. This has been confirmed by oxidation of melibiose with bromine water to melibionic acid, and this, on methylation followed by hydrolysis, gives 2 : 3 : 4 : 5-tetra-*O*-methyl-*D*-gluconic acid and 2 : 3 : 4 : 6-tetra-*O*-methyl-*D*-galactose; the structure of the former is shown by the fact that, on oxidation with nitric acid, it forms tetramethylsaccharic acid. There has been some doubt about the nature of the glycosidic link, but the evidence appears to be strongly in favour of  $\alpha$ -. Thus the structure of melibiose is ( $\beta$ -form) [see also §7g]:

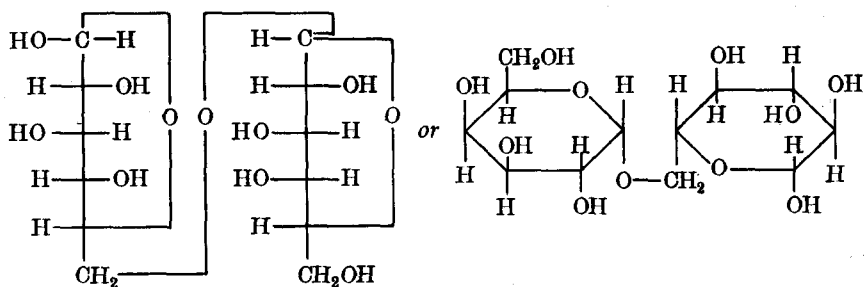

Melibiose has been synthesised chemically.

**§19. Gentiobiose** (6-*O*- $\beta$ -*D*-glucopyranosyl-*D*-glucopyranose). This was originally obtained from the trisaccharide, gentianose (§20), but it also occurs in some glycosides, *e.g.*, amygdalin (§27). Gentiobiose is a reducing sugar, forms an osazone and undergoes mutarotation; hydrolysis with dilute acids produces two molecules of *D*-glucose. Since this hydrolysis is also effected by emulsin, the glycosidic link must be  $\beta$ -. Methylation, followed by hydrolysis, gives 2 : 3 : 4-trimethyl-*D*-glucose and 2 : 3 : 4 : 6-tetramethyl-*D*-glucose. Oxidation to gentiobionic acid, this then methylated and followed by hydrolysis, gives 2 : 3 : 4 : 5-tetramethyl-*D*-gluconic acid and 2 : 3 : 4 : 6-tetramethyl-*D*-glucose. Thus gentiobiose is ( $\beta$ -form):

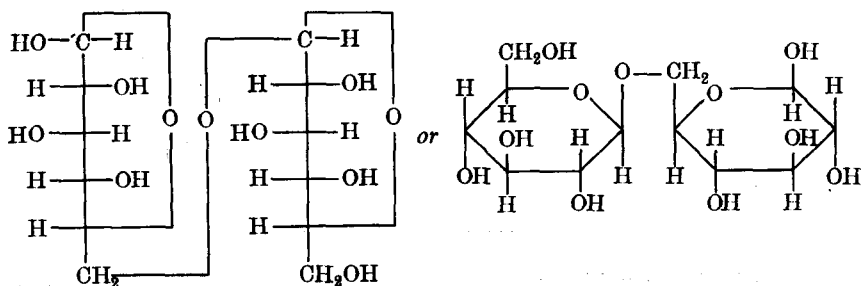

Gentiobiose has been synthesised chemically.

Another disaccharide containing the 1 : 6-glycosidic link is primeverose (§26).

**§20. Trisaccharides.** The trihexose trisaccharides have the molecular formula  $C_{18}H_{32}O_{16}$ . They are of two types, reducing and non-reducing.

**Manninotriose** is the only reducing trisaccharide that has been isolated from natural sources. All the others of this group have been obtained by degrading polysaccharides or by synthesis, *e.g.*, **cellotriase** from cellulose. Two important non-reducing trisaccharides are raffinose and gentianose.

**Raffinose** occurs in many plants, particularly beet. Controlled hydrolysis with dilute acids gives D-fructose and melibiose; vigorous hydrolysis gives D-fructose, D-glucose and D-galactose. It is also hydrolysed by the enzyme invertase to fructose and melibiose, and by an  $\alpha$ -glycosidase to galactose and sucrose. These facts show that the three monosaccharide molecules are linked in the following order:

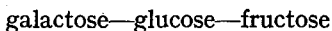

This arrangement is confirmed by the products obtained by methylation of raffinose, followed by hydrolysis, *viz.*, 2 : 3 : 4 : 6-tetramethylgalactose, 2 : 3 : 4-trimethylglucose and 1 : 3 : 4 : 6-tetramethylfructose. Furthermore, since the structures of sucrose (§13) and melibiose (§18) are known, the structure of raffinose must therefore be:

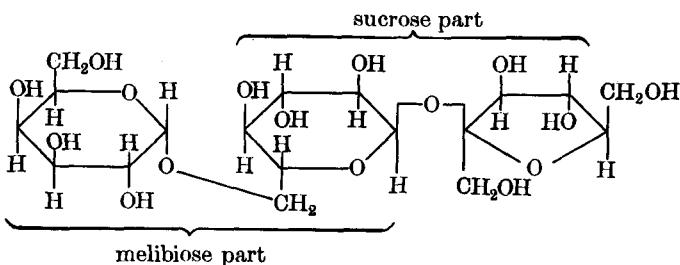

**Gentianose** occurs in gentian roots. Controlled hydrolysis with dilute acids gives D-fructose and gentiobiose; this hydrolysis is also effected by the enzyme invertase. Emulsin also hydrolyses gentianose to D-glucose and sucrose. Thus the arrangement of the three monosaccharide molecules is:

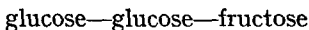

Hence the structure of gentianose is:

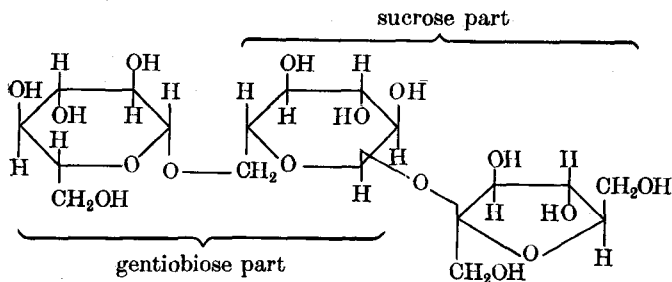

### POLYSACCHARIDES

Polysaccharides are high polymers of the monosaccharides, and may be roughly divided into two groups: those which serve as "structures" in plants and animals, *e.g.*, cellulose, and those which act as a metabolic reserve in plants and animals, *e.g.*, starch.

§21. **Cellulose.** The molecular formula of cellulose is  $(C_6H_{10}O_5)_n$ . When hydrolysed with fuming hydrochloric acid, cellulose gives D-glucose in 95–96

per cent. yield (Irvine *et al.*, 1922); therefore the structure of cellulose is based on the D-glucose unit. Methylation, acetylation, or "nitration" of cellulose produces a trisubstitution product as a maximum substitution product, and it therefore follows from this that each glucose unit present has *three* hydroxyl groups in an uncombined state. When fully methylated cellulose is hydrolysed, the main product is 2 : 3 : 6-tri-*O*-methyl-D-glucose (90 per cent.). Thus the three free hydroxyl groups in each glucose unit must be in the 2, 3 and 6 positions, and positions 4 and 5 are therefore occupied. Now, if we assume that the ring structure is present in each unit, then this would account for position 5 (or alternatively, 4) being occupied. Furthermore, if we also assume that the glucose units are linked by C<sub>1</sub> of one unit to C<sub>4</sub> of the next (or alternatively, C<sub>5</sub>), then the following tentative structure for cellulose would account for the facts:

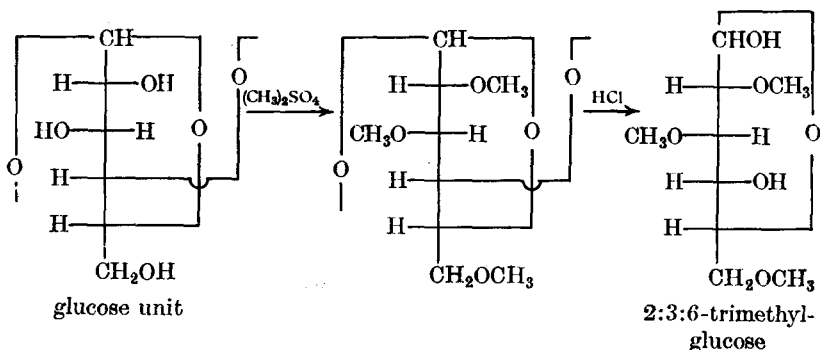

It should be noted, however, that if the linkages at 4 and 5 were interchanged, the same trimethylglucose would still be obtained on hydrolysis (*cf.* maltose, etc.).

When subjected to acetolysis, *i.e.*, simultaneous acetylation and hydrolysis (this is carried out with a mixture of acetic anhydride and concentrated sulphuric acid), cellulose forms cellobiose octa-acetate. Thus the cellobiose unit is present in cellulose, and since the structure of cellobiose is known (see §16), it therefore follows that the glucose units are present in the pyranose form, *i.e.*, C<sub>5</sub> is involved in ring formation, and so the glucose units are linked C<sub>1</sub>—C<sub>4</sub>. The isolation of cellobiose indicates also that *pairs* of glucose units are joined by  $\beta$ -links, but it does indicate whether the links between the

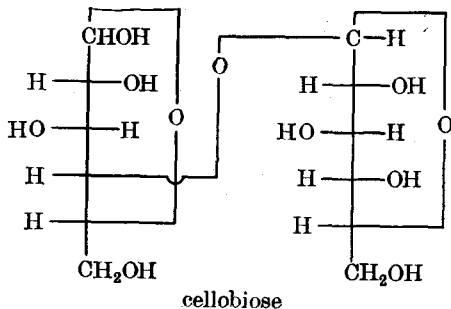

glucose units are the same (all  $\beta$ -) or alternate ( $\alpha$  and  $\beta$ ), since all the links could be  $\beta$ -, or each pair of cellobiose units could be joined by  $\alpha$ -links; the latter possibility is not likely, but it is not definitely excluded. Very careful acetolysis of cellulose, however, has produced a cellotriose, cellotetraose and

a cellopentaose, and in all of these the  $C_1-C_4$  links have been shown to be  $\beta$ - (from calculations of the optical rotations), and so we may conclude that all the links in cellulose are  $\beta$ -. This conclusion is supported by other evidence, *e.g.*, the kinetics of hydrolysis of cellulose.

Cellulose forms colloidal solutions in solvents in which glucose is soluble, and so it is inferred that cellulose is a very large molecule. Moreover, since cellulose forms fibres, *e.g.*, rayon, it appears likely that the molecule is linear; X-ray analysis also indicates the linear nature of the molecule, and that the cellulose molecule has a long length. Hence a possible structure for cellulose is:

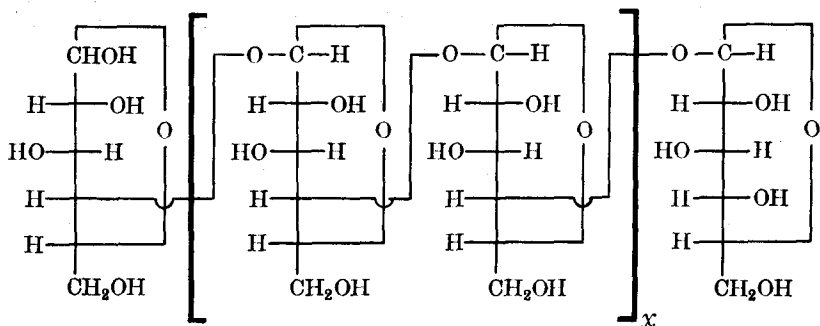

cellobiose units

Ia

or

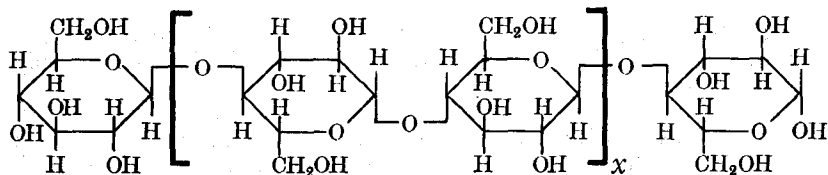

Ib

It should be noted that in the structure given for cellulose, the first glucose unit in Ia (*i.e.*, the one on the left-hand side; this unit is on the right-hand side in Ib) has a free reducing group, but since this group is at the end of a very long chain, its properties tend to be masked; thus cellulose does not exhibit the strong reducing properties of the sugars.

The cellulose molecule is not planar, but has a screw-axis, each glucose unit being at right angles to the previous one. Although free rotation about the C—O—C link might appear possible at first sight, it apparently does not occur owing to the steric effect. This and the close packing of the atoms give rise to a rigid chain molecule. The long chains are held together by hydrogen bonding, and thus cellulose has a three-dimensional brickwork. This would produce strong fibres with great rigidity but no flexibility, and consequently, although the fibres would have great tensile strength, they could not be knotted without snapping. Since the fibres can be knotted without snapping, they must possess flexibility, and the presence of the latter appears to be due to the partly amorphous character of cellulose.

The chemical structure of cellulose appears to be more complicated than the one given above. Schmidt *et al.* (1932) showed that carboxyl groups are present in carefully purified cotton fibres. Kleinert *et al.* (1944) have suggested that various other groups, which are not necessarily carbohydrate in

nature, may bind the glucose chains together. It should be remembered, in this connection, that 100 per cent. glucose is never obtained from the hydrolysis of cellulose.

**The molecular weight of cellulose.** Owing to its insolubility, simple methods of molecular weight determination (depression of freezing point and elevation of boiling point) cannot be applied to cellulose.

**Chemical methods.** Examination of the formula of cellulose shows that on methylation, followed by hydrolysis, the end unit (the non-reducing end) would contain four methoxyl groups, and all the other units three. Hence, by the determination of the percentage of the tetramethyl derivative (2 : 3 : 4 : 6-) it is therefore possible to estimate the length of the chain. Haworth (1932) separated the methylated glucoses by vacuum distillation; Hibbert (1942) used fractional distillation; Bell (1944), using silica, and Jones (1944), using alumina, effected separation by means of chromatography. The value for the molecular weight of cellulose was found to be between 20,000 and 40,000 (Haworth, 1932); this corresponds approximately to 100 to 200 glucose units. This "end-group assay", however, gives rise to the following difficulty. When cellulose is very carefully prepared from cotton, and then methylated in an atmosphere of nitrogen, *i.e.*, in the absence of oxygen, no 2 : 3 : 4 : 6-tetramethylglucose was obtained after hydrolysis (Haworth *et al.*, 1939). One explanation that has been offered is that during methylation under ordinary conditions, *i.e.*, in air, cellulose is partially degraded, *e.g.*, osmotic pressure measurements carried out on methylated cellulose, produced by two methylations in air, gave a value of 190 glucose units; sixteen successive methylations in air gave a methylated cellulose of 45 glucose units, as estimated by osmotic pressure measurements (Haworth *et al.*, 1939). Haworth explained these results by suggesting that the cellulose molecule consists of a very large loop, which undergoes progressive shortening on methylation. When the methylation is carried out in an atmosphere of nitrogen, the exposed ends of the shortened loop recombine, but cannot do so when methylated in the presence of air. Haworth also suggested that in order that the two chains should be held parallel to form a loop, it is necessary to have cross-linkages holding the two sides together. The nature of these suggested cross-links is unknown. If primary valencies were involved, then some *dimethylglucose* should be obtained from the hydrolysate. Some of this compound has in fact been isolated, but it is not certain that it is actually present in the methylated cellulose, since it may arise by demethylation during the degradation of the methylated cellulose. The following is a pictorial representation of Haworth's suggestion.

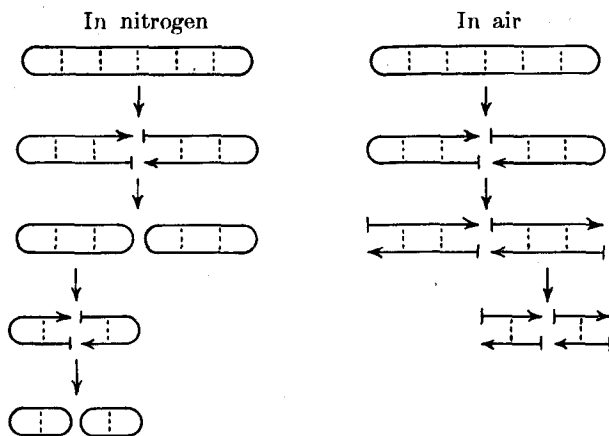

By means of chromatography, McGilvray (1953) has detected 2 : 3 : 4 : 6-tetra-*O*-methyl-*D*-glucose in the hydrolysate after the methylation of cellulose in an atmosphere of nitrogen. Thus degradation of the chain has occurred under these conditions, and so there is no evidence for the linking of the end groups in the absence of oxygen. Furthermore, McGilvray determined the degree of polymerisation from viscosity and osmotic pressure measurements, and also from the end-group assay. The values obtained from the first two methods were greater than that obtained from the third method, and McGilvray suggests these results may be accounted for by assuming a slightly branched structure for the soluble methylcelluloses.

A number of other chemical methods have been used for estimating the molecular weight of cellulose, *e.g.*, that of Hirst *et al.* (1945); this is based on the periodate oxidation (§7g). Examination of the formula of cellulose shows that the terminal reducing unit would give two molecules of formic acid and one of formaldehyde (this reducing unit, which is left in *Ia*, behaves as the open-chain molecule, since it is *not* a glycoside), whereas the other terminal unit (right in *Ia*) would give one molecule of formic acid; *i.e.*, one cellulose molecule gives three molecules of formic acid and one of formaldehyde. Estimation of the formic acid produced gives the value of the chain-length as approximately 1000 glucose units. There appears, however, to be some uncertainty with these results, since "over-oxidation" as well as normal oxidation with periodic acid results, the former possibly being due to the progressive attack on the chain-molecules from their reducing ends (Head, 1953).

**Physical methods.** Ultracentrifuge measurements have given a value of 3600 glucose units for *native* cellulose; lower values were obtained for purified cellulose and its derivatives (Kraemer, 1935). These differences are probably due to the degradation of the chains during the process of purification and preparation of the derivatives. Viscosity measurements on cellulose in Schweitzer's solution give a value of 2000–3000 glucose units; lower values were obtained for viscosity measurements on derivatives of cellulose in organic solvents (Staudinger *et al.*, 1935–1937). Osmotic pressure measurements on derivatives of cellulose have given values of approximately 1000 glucose units (Meyer, 1939). Schulz *et al.* (1954, 1958) have determined the molecular weight of cellulose nitrate by measurements of viscosity, etc., and obtained results varying from 1400 to 7800 glucose units, the value depending on the source of the cellulose.

From the foregoing account, it can be seen that the values obtained chemically and physically are not in agreement. This indicates the uncertainty of the value of *n*, and also that the value of *n* depends on the source and treatment of cellulose. However, the more recent work of Schulz (see above) is reliable in that evidence was obtained that no degradation occurred in the course of purification and conversion into the nitrates.

**§22. Starch.** The molecular formula of starch is  $(C_6H_{10}O_5)_n$ . Hydrolysis of starch with acids produces a quantitative yield of *D*-glucose (*cf.* cellulose); thus the structure of starch is based on the glucose unit. Methylation of starch gives the trimethylated compound (maximum substitution), and this, on hydrolysis, produces 2 : 3 : 6-tri-*O*-methyl-*D*-glucose as the main product, and a small amount (about 4.5 per cent.) of 2 : 3 : 4 : 6-tetra-*O*-methyl-*D*-glucose. Oxidation studies (periodic acid) have also shown the presence of 1 : 4-linked *D*-glucopyranose residues. Starch is hydrolysed by the enzyme diastase ( $\beta$ -amylase) to maltose (see also below). Thus the maltose unit is present in starch, and so we may conclude that all the glucose units are joined by  $\alpha$ -links (*cf.* cellulose). The following structure for starch fits these facts:

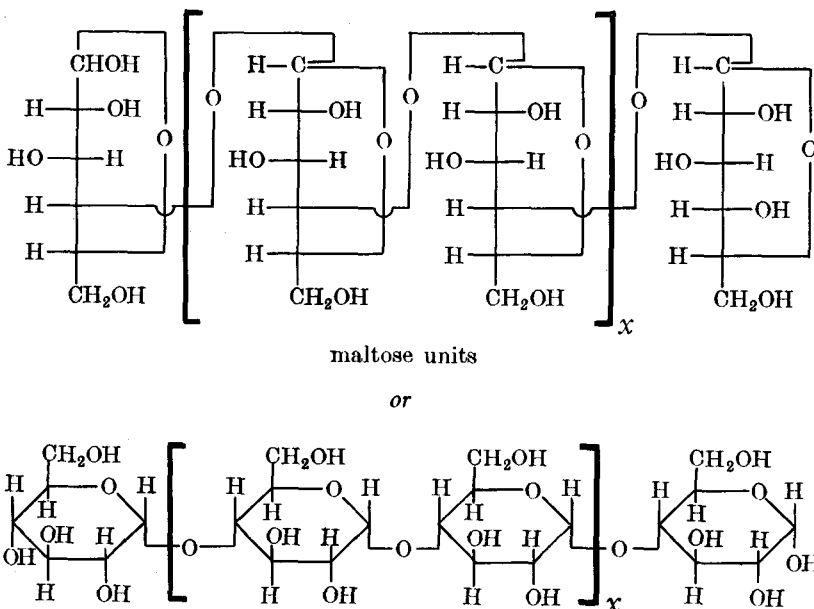

The Haworth end-group assay (1932) showed that starch is composed of approximately 24–30 glucose units. Thus starch is a linear molecule, at least as far as 24–30 units. Haworth, however, pointed out that this was a *minimum* chain-length, and that starches may differ by having different numbers of this repeating unit (see also below). Viscosity measurements, however, showed the presence of a highly branched structure. Now, it has long been known that starch can be separated into two fractions, but it is only fairly recently that this separation has been satisfactorily carried out; the two fractions are  $\alpha$ -amylose (the A-fraction; 17–34 per cent.) and  $\beta$ -amylose (amylopectin, or the B-fraction). The fractionation has been carried out in several ways, *e.g.*, *n*-butanol is added to a hot colloidal solution (aqueous) of starch, and the mixture allowed to cool to room temperature. The A-fraction is precipitated, and the B-fraction is obtained from the mother liquors by the addition of methanol (Schoch, 1942). Haworth *et al.* (1946) have used thymol to bring about selective precipitation.

$\alpha$ -Amylose is soluble in water, and the solution gives a blue colour with iodine.  $\beta$ -Amylose is insoluble in water, and gives a violet colour with iodine. Both amyloses are mixtures of polymers, and the average molecular weight depends on the method of preparation of the starch used.

**$\alpha$ -Amylose (A-fraction).** Meyer *et al.* (1940) measured the osmotic pressure of solutions of  $\alpha$ -amylose acetate, and obtained values of 10,000–60,000 for the molecular weight; values up to 1,000,000 have been reported. When  $\alpha$ -amylose with a chain-length of about 300 glucose units (as shown by osmotic pressure measurements) was methylated and then hydrolysed, about 0.3 per cent. of 2:3:4:6-tetra-*O*-methyl-*D*-glucose was obtained. This value is to be expected from a straight chain composed of approximately 300 glucose units. From this evidence it would therefore appear that  $\alpha$ -amylose is a *linear* polymer, and this is supported by the early work with soya-bean  $\beta$ -amylase (diastase). This enzyme converts  $\alpha$ -amylose into maltose in about 100 per cent. yield; this indicates that a large number of maltose units are joined by  $\alpha$ -links, *i.e.*,  $\alpha$ -amylose is a linear molecule. Peat *et al.* (1952), however, showed that highly purified soya-bean  $\beta$ -amylase

gives only about 70 per cent. of maltose, and this has been confirmed by other workers. Since  $\beta$ -amylase only attacks  $\alpha$ -1 : 4-glucosidic linkages, it thus appears that  $\alpha$ -amylose contains a small number of other linkages. Careful purification of "crude" soya-bean  $\beta$ -amylase showed the presence of two enzymes,  $\beta$ -amylase and another which was named Z-enzyme; it is the latter which was shown to hydrolyse the non  $\alpha$ -1 : 4-linkages. Thus unpurified  $\beta$ -amylase (which contains both enzymes) degrades  $\alpha$ -amylose completely to maltose. It has also been shown that Z-enzyme has  $\beta$ -glucosidase activity and that emulsin can hydrolyse these "anomalous" linkages. These observations suggest that  $\alpha$ -amylose contains a small number of  $\beta$ -glucosidic linkages.

Another difficulty arises from the fact that the structure of potato amylose depends on its method of preparation, *e.g.*, one sample is completely degraded by purified  $\beta$ -amylase, whereas other samples are not. The first sample represents about 40 per cent. (by weight) of the total amylose in potato starch, and thus it follows that potato amylose is heterogeneous both in structure and in size. A large proportion is completely linear (and contains about 2000 glucose units), and the remainder (which contains about 6000 units) contains a small number of these anomalous linkages. The nature of these anomalous linkages is still uncertain.

**Amylopectin (B-fraction).** Molecular weight determinations of amylopectin by means of osmotic pressure measurements indicate values of 50,000 to 1,000,000 (Meyer *et al.*, 1940). Larger values have also been reported, *e.g.*, Witnauer *et al.* (1952) have determined the molecular weight of potato amylopectin by the method of light scattering, and report an average value of 10,000,000 or more. Let us consider an amylopectin having an average molecular weight of 550,000; this corresponds to about 3000 glucose units. The end-group assay by methylation shows the presence of one unit with four free hydroxyl groups per 24-30 glucose units; the same results are also obtained by the periodate method. Thus the 3000 units are joined in such a manner as to give about 100 end units; it therefore follows that the chain must be *branched*. The problem is further complicated by the fact that Hirst (1940), after methylating amylopectin and hydrolysing the product, obtained, in addition to tri- and tetra-*O*-methyl-D-glucose, about 3 per cent. of 2 : 3-di-*O*-methyl-D-glucose. This has been taken to mean that some glucose units are also joined by C<sub>1</sub> and C<sub>6</sub> atoms. Furthermore, in certain experiments, enzymic hydrolysis has given a small amount of 1 : 6  $\alpha$ -linked diglucose, *i.e.*, isomaltose is also present in amylopectin (Montgomery *et al.*, 1947, 1949). Wolfrom *et al.* (1955, 1956) have obtained evidence that there is also an  $\alpha$ -D-1 : 3-bond in amylopectin; the principal bond is  $\alpha$ -D-1 : 4, and branching occurs through  $\alpha$ -D-1 : 6-bonds.

The branching of the chains in amylopectin is supported by the following evidence:

(i) Amylopectin acetate does not form fibres; fibre formation is characteristic of *linear* molecules.

(ii)  $\beta$ -Amylase hydrolyses amylopectin to give only about 50 per cent. of maltose. Thus there are "blocked" points, and these will occur at the branch points.

(iii) Amylopectin solutions do not show an orientation of the molecules in the direction of flow in the concentric cylinder technique; the molecules are therefore not linear.

The detailed structure of amylopectin is still not settled. Haworth and Hirst (1937) suggested a laminated formula for amylopectin; each line represents a basal chain of 24-30 glucose units joined by  $\alpha$  C<sub>1</sub>-C<sub>4</sub> links, and each arrow head represents the joining of the terminal reducing group (C<sub>1</sub>) of each chain to the central glucose member (at C<sub>6</sub>) of the next chain.



If it is branched in the fashion shown, then methylated amylopectin should give some dimethylglucose on hydrolysis. Since 2 : 3-di-*O*-methyl-D-glucose is actually obtained, the link must be  $C_1$  of one chain to  $C_6$  of the next. If

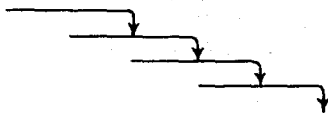

the unions are as regular as this, then there will be one  $C_1$ - $C_6$  link for every one end group. Hirst *et al.* (1945), however, showed by the end-group assay by the periodic acid method that amylopectin contains only traces of glucose residues joined solely by  $C_1$ - $C_6$  links.

Prolonged methylation of amylopectin produces a diminution of the molecular size (as determined by physical methods); *e.g.*, methylation of starch seventeen times changed the particle size from 3000 glucose units to 190 units (Averill, 1939). This diminution in particle size cannot be due to the break-down of the basal chains, since the end-group assay always gives the same basal chain-length, whether the methylation is carried out in air or in an atmosphere of nitrogen. Haworth therefore suggested that this diminution in particle size is due to the "disaggregation" of the basal chains.

As pointed out previously,  $\beta$ -amylase gives only 50 per cent. of maltose with amylopectin. The high molecular weight residue is known as **dextrin**, and this is not degraded because of the presence of the  $C_1$ - $C_6$  link ( $\beta$ -amylase breaks only  $\alpha$   $C_1$ - $C_4$  links). According to Haworth (1946),  $\beta$ -amylase attacks the chain, breaking them into units of two, the attack stopping at the cross-links. Thus:

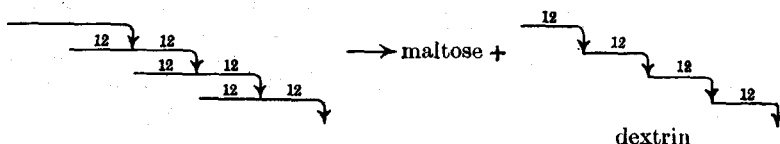

In support of this explanation, it has been found that dextrin has a unit chain-length of 11-12 glucose units.

Further work has shown that the Haworth laminated formula does not satisfy the behaviour of amylases on amylopectin; the formula is far too regular (*cf.* Hirst's work, above). Meyer (1940) proposed a highly branched structure; this fits the behaviour of the amylases better. Furthermore,

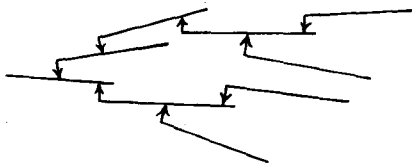

mathematical calculations have shown that the regular form is unlikely. A difficulty of the Meyer structure, however, is that amylopectin would be globular; this is not in keeping with all the evidence.

**§23. Some other polysaccharides.** A number of other polysaccharides besides cellulose and starch also occur naturally, and some of these are described briefly below.

**Glycogen.** This is the principal reserve carbohydrate in animals. It is

hydrolysed by  $\beta$ -amylase to maltose, and molecular weight determinations by physical methods give values between 1 and 2,000,000. The molecular structure of glycogen appears to be similar to that of amylopectin; both polysaccharides have many features in common. One main difference is their degree of branching, the average chain-length in amylopectin being about 24 glucose units and in glycogen about 12.

**Inulin.** This is a fructosan, and occurs in dahlia tubers, dandelion roots, etc. Acid hydrolysis gives D-fructose, but if inulin is first methylated and then hydrolysed, 3 : 4 : 6-tri-*O*-methyl-D-fructose is the main product, thus indicating that inulin is composed of fructofuranose units.

**Mannans** are polysaccharides which yield only mannose on hydrolysis; they are found in ivory nut, seaweeds, bakers' yeast, etc. Similarly, **galactans** yield only galactose on hydrolysis; they occur in seeds, wood, etc. There are also polysaccharides which contain pentose residues only, *viz.* **pentosans**, *e.g.*, **xylans** give D-xylose; *arabans* give L-arabinose. Some pentosans are composed of both xylose and arabinose, and other polysaccharides are composed of pentose and hexose units, *e.g.*, *xylo-glucans* (xylose and glucose), *arabo-galactans*, etc. In addition to these neutral polysaccharides, there are also the acid polysaccharides. These are gums and mucilages, and owe their acidity to the presence of uronic acids. Gums are substances which swell in water to form gels (or viscous solutions), *e.g.*, gum arabic and gum tragacanth; on hydrolysis, the former gives arabinose, galactose, rhamnose and glucuronic acid, and the latter xylose, L-fructose and galacturonic acid. Mucilages are polysaccharides which swell in water to form viscous solutions; on hydrolysis, they give galacturonic acid, arabinose, xylose, etc. The **hemi-celluloses** (which are widely distributed in the cell-wall of plants) also contain both uronic acids (glucuronic or galacturonic) and pentoses (xylose, arabinose).

**Pectin.** This occurs in plants, particularly fruit juices. It is composed of D-galacturonic acid residues and the methyl ester.

**Alginate acid.** This occurs in the free state and as the calcium salt in various seaweeds. Hydrolysis of alginate acid produces D-mannuronic acid.

**Chitin.** This is the polysaccharide that is found in the shells of crustaceans. Hydrolysis of chitin by acids produces acetic acid and D-glucosamine (chitosamine; 2-aminoglucose). Chitin is also hydrolysed by an enzyme (which occurs in the intestine of snails) to *N*-acetylglucosamine. X-ray analysis has shown that the structure of chitin is similar to that of cellulose (*N*-acetylglucosamine replaces glucose).

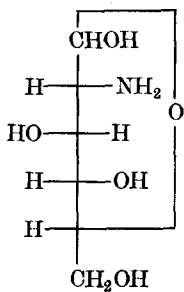

D-glucosamine

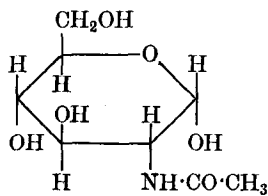
*N*-acetylglucosamine

*N*-Methyl-L-glucosamine is a component of streptomycin (see §7. XVIII).

§23a. **Photosynthesis of carbohydrates.** The scheme outlined below is largely that proposed by Calvin *et al.* (1954). These authors exposed certain algae to carbon dioxide (labelled with  $^{14}\text{C}$ ) and light, then killed the

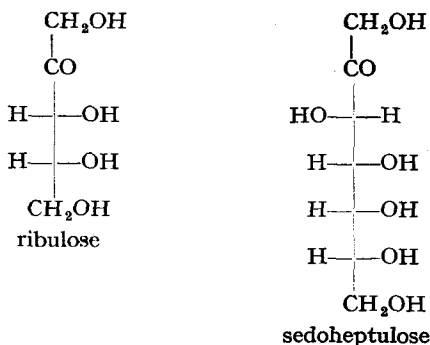

algæ and extracted with ethanol and chromatographed (on paper) the extract. Two monosaccharides, ribulose and sedoheptulose, play an essential part in the photosynthesis of carbohydrates, and the steps involved are as follows :

(i) Ribulose diphosphate accepts one molecule of carbon dioxide and one of water.

(ii) The product now splits into two molecules of phosphoglyceric acid ( $\text{CH}_2\text{O}\cdot\text{PO}_3\text{H}_2\cdot\text{CHOH}\cdot\text{CO}_2\text{H}$ ).

(iii) Phosphoglyceric acid undergoes reduction to phosphoglyceraldehyde.

(iv) Two molecules of phosphoglyceraldehyde combine to form hexose phosphate.

(va) Hexose phosphate forms disaccharides and polysaccharides.

(vb) A molecule of hexose phosphate reacts with a molecule of phosphoglyceraldehyde to form ribulose phosphate and a tetrose phosphate. The latter reacts with a molecule of phosphoglyceraldehyde to produce sedoheptulose phosphate which, in turn, also reacts with a molecule of phosphoglyceraldehyde to produce one molecule of ribose phosphate and one molecule of ribulose phosphate. The ribose phosphate is then converted into ribulose phosphate, thus completing the cycle.

All the aldohexoses and all the aldopentoses are interconvertible by inversion of one asymmetric carbon atom, but how this occurs in the plant is not certain. Furthermore, aldohexoses may be stepped down to aldopentoses, and again how this occurs is not certain; one suggestion is (see also §32a. VIII):

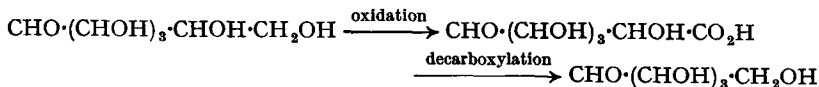

The foregoing account of photosynthesis describes the various intermediates produced. In green plants the presence of chlorophyll (§6. XIX) is necessary for photosynthesis, but its exact function is not certain. It appears that all the light energy is used in the "light phase" to raise chlorophyll *a* from its ground state to an excited state, and then this energy of the excited state is used in the "dark phase" to convert carbon dioxide into carbohydrates (Trebst *et al.*, 1958-1960). Furthermore, the same series of dark-phase reactions has also been shown to occur in non-chlorophyllous cells (*inter alia*, McFadden *et al.*, 1957, 1959). What is peculiar to photosynthesis is its light phase.

## GLYCOSIDES

**§24. Introduction.** A great variety of glycosides occur in plants. The simple glycosides are colourless, soluble in water and are optically active; they do not reduce Fehling's solution. On hydrolysis with inorganic acids, glycosides give a sugar and a hydroxylic compound, the aglycon (§3), which may be an alcohol or a phenol. Most glycosides are hydrolysed by emulsin; therefore they are  $\beta$ -glycosides. Actually, in the natural state, each glycoside is usually associated with an enzyme which occurs in different cells of the plant. Maceration of the plant thus produces hydrolysis of the glycoside by bringing the enzyme in contact with the glycoside. Glucose has been found to be the most common sugar component; when methylated and then hydrolysed, most glycosides give 2 : 3 : 4 : 6-tetra-*O*-methyl-D-glucose. Thus most glycosides are  $\beta$ -D-glucopyranosides.

**Synthesis of glycosides.** The synthesis of a glycoside uses an **aceto-bromohexose** as the starting material; this compound is now named systematically as a tetra-*O*-acetyl-D-hexopyranosyl 1-bromide, e.g., if the hexose is glucose, then the  $\alpha$ -form will be tetra-*O*-acetyl- $\alpha$ -D-glucopyranosyl 1-bromide.

When glucose is treated with acetic anhydride at 0° in the presence of zinc chloride, the product is 1 : 2 : 3 : 4 : 6-penta-*O*-acetyl- $\alpha$ -D-glucose ( $\alpha$ -D-glucose penta-acetate). If, however, glucose is heated with acetic anhydride in the presence of sodium acetate, the product is 1 : 2 : 3 : 4 : 6-penta-*O*-acetyl- $\beta$ -D-glucose. Furthermore, the  $\beta$ -isomer may be converted into the  $\alpha$ - by heating with acetic anhydride at 110° in the presence of zinc chloride.

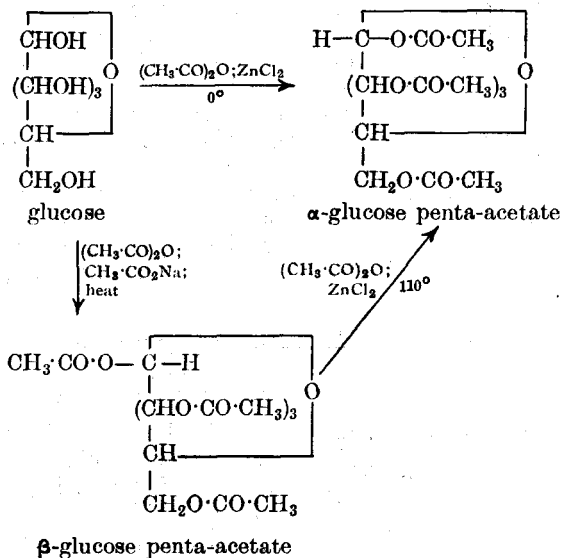

These penta-acetates are readily hydrolysed to glucose by means of dilute aqueous sodium hydroxide, ethanolic ammonia at 0°, or by methanol containing a small amount of sodium methoxide. When dissolved in glacial acetic acid saturated with hydrogen bromide, the glycosidic acetoxy group of a hexose penta-acetate is replaced by bromine to give an  $\alpha$ -acetobromohexose; the  $\alpha$ -isomer is obtained whether the penta-acetate used is the  $\alpha$ - or  $\beta$ -compound (Fischer, 1911). Thus a Walden inversion occurs with the  $\beta$ -compound (§1. III).

Scheurer *et al.* (1954) have synthesised acetobromo sugars in good yield as follows. Bromine is added to a suspension of red phosphorus in glacial acetic acid, and to this solution (which now contains acetyl bromide) is added the sugar or acetylated sugar, the latter giving the better yields.

The bromine atom in these acetobromohexoses is very active. Thus it may be replaced by a hydroxyl group when the acetobromohexose is treated with silver carbonate in moist ether (Fischer *et al.*, 1909), or by an alkoxy group when treated with an alcohol in the presence of silver carbonate (Königs and Knorr, 1901). In the latter reaction the yields are improved if anhydrous calcium sulphate and a small amount of iodine are used instead of silver carbonate (Evans *et al.*, 1938). In either case, the  $\alpha$ -acetobromohexose gives the  $\beta$ -glycoside. On the other hand, if mercuric acetate is used instead of silver carbonate, then the  $\alpha$ -glycoside is obtained. The foregoing reactions may thus be written (using the symbol  $\rightarrow$  to represent a Walden inversion; see §3. III).

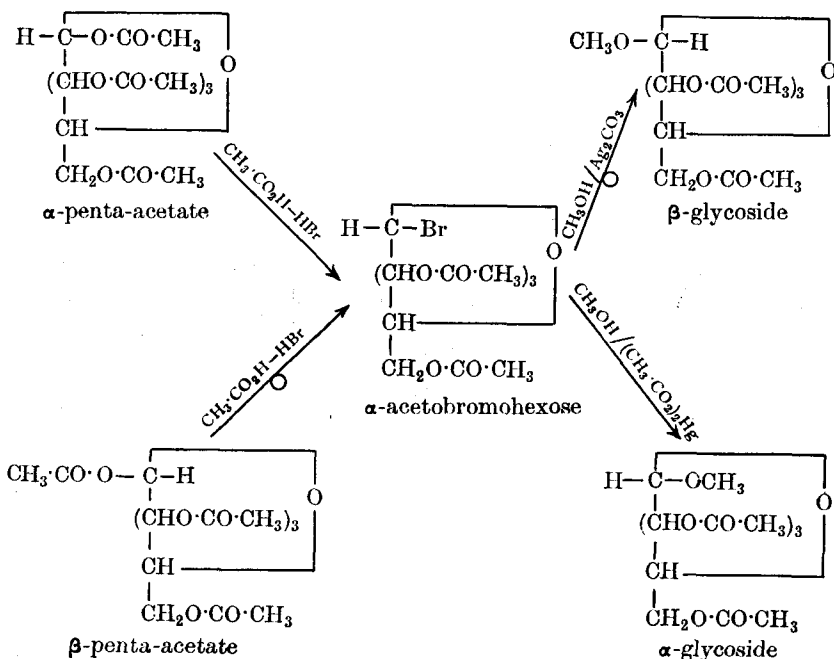

**§25. Indican.** This glycoside occurs in the leaves of the indigo plant and in the woad plant. When the leaves are macerated with water, the enzyme present hydrolyses indican to glucose and indoxyl, and the latter, on exposure to air, is converted into indigotin (see Vol. I).

The molecular formula of indican is  $\text{C}_{14}\text{H}_{17}\text{O}_6\text{N}$ , and since it gives D-glucose and indoxyl on hydrolysis, it is therefore indoxyl D-glucoside. When indican is methylated (with methyl iodide in the presence of dry silver oxide), tetramethylindican is obtained, and this, on hydrolysis with methanol containing 1 per cent. hydrogen chloride, gives indoxyl and methyl 2 : 3 : 4 : 6-tetra-O-methyl-D-glucoside. Thus the glucose molecule is present in the pyranose form, and since indican is hydrolysed by emulsin, the glycosidic link must be  $\beta$ . Thus the structure of indican is III, and this has been confirmed by synthesis from indoxyl, I, and tetra-O-acetyl- $\alpha$ -D-glucopyranosyl 1-bromide, II, as follows:

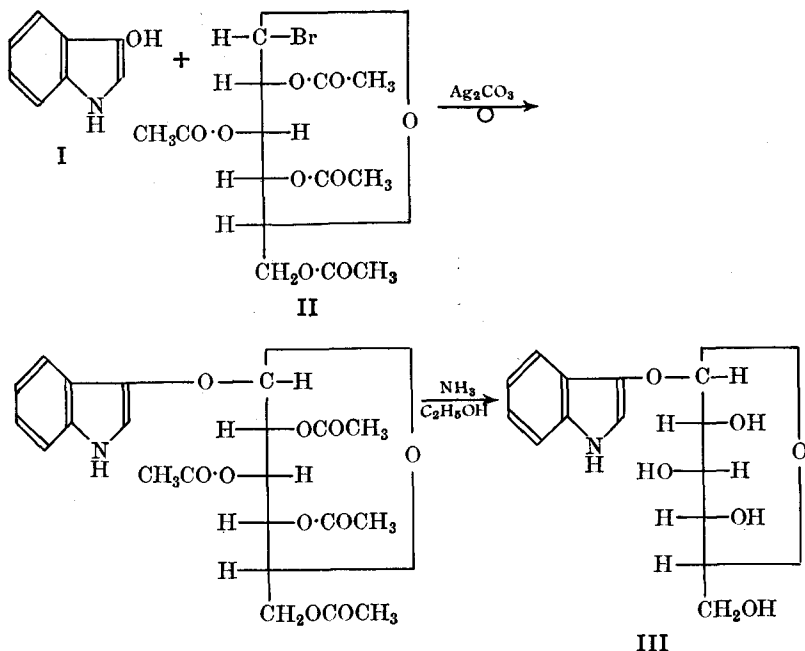

§26. **Ruberythric acid.** This occurs in the madder root, and on hydrolysis, it was originally believed to give one molecule of alizarin and two molecules of D-glucose. Jones and Robertson (1933), however, showed that two molecules of D-glucose were not present in the hydrolysate; a mixture of two sugars was actually present, D-glucose and D-xylose. Thus the molecular formula of ruberythric acid is  $\text{C}_{25}\text{H}_{26}\text{O}_{13}$ , and not, as was originally believed,  $\text{C}_{26}\text{H}_{28}\text{O}_{14}$ . Thus the hydrolysis is:

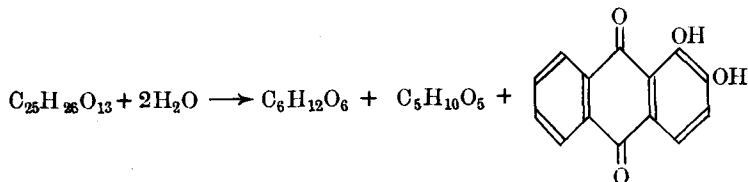

Jones and Robertson also showed that the two monosaccharide molecules were present in the form of the disaccharide **primeverose**. Now, this disaccharide is 6-O-β-D-xylopyranosyl-D-glucopyranose (Helferich, 1927), and

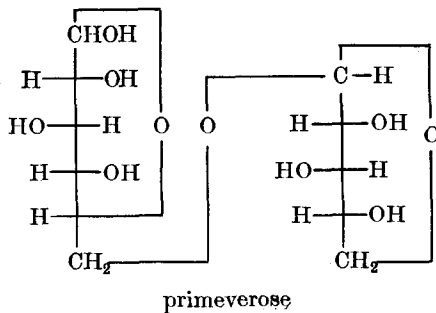

it therefore follows that alizarin is linked to the glucose half of the primeverose molecule. Further work has shown that the glucosidic link is  $\beta$ , and that it is the 2-hydroxyl group of alizarin that is involved. Thus the structure of ruberythric acid is:

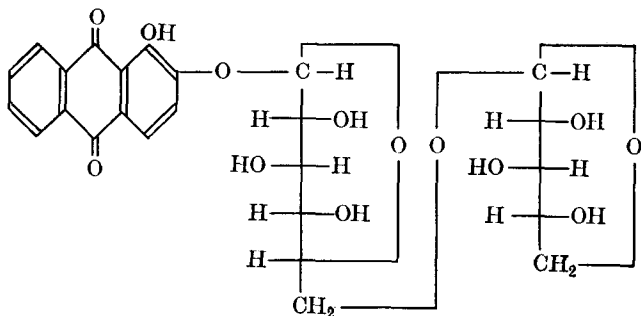

**§27. Amygdalin.** This occurs in bitter almonds. The molecular formula is  $C_{20}H_{27}O_{11}N$ , and it is hydrolysed by acids to one molecule of benzaldehyde, two molecules of D-glucose, and one of hydrogen cyanide.

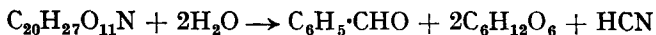

Since emulsin also brings about this hydrolysis, amygdalin must contain a  $\beta$ -glycosidic link. On the other hand, the enzyme zymase hydrolyses amygdalin into one molecule of glucose and a glucoside of (+)-mandelonitrile (this compound is

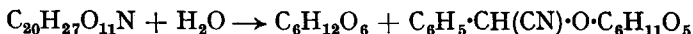

identical with *prunasin*, a naturally occurring glucoside). Thus the aglycon of amygdalin is (+)-mandelonitrile, and the sugar is a disaccharide. Haworth *et al.* (1922, 1923) have shown that this disaccharide is gentiobiose (§19), and have synthesised amygdalin (in 1924) as follows. Gentiobiose, I, was converted into hepta-acetyl-bromogentiobiose, II, by means of acetic anhydride saturated with hydrogen bromide, and then II was condensed with racemic ethyl mandelate in the presence of silver oxide, whereby the  $\beta$ -glycoside, III, was obtained. Treatment of this with ethanolic ammonia hydrolysed the acetyl groups, and at the same time converted the ester group into the corresponding amide; thus the ( $\pm$ )-amido-glycoside, IV, was obtained. IV was then treated with acetic anhydride in pyridine solution, and the ( $\pm$ )-hepta-acetyl derivative of the amide, V, was then separated into its diastereoisomers by fractional crystallisation (the mandelic acid portion is + and -, the gentiobiose portion is +; hence the two forms present are ++ and -+, *i.e.*, they are diastereoisomers). The (+)-form was then dehydrated with phosphorus pentoxide to give the (+)-nitrile, VI, and this, on de-acetylation with ethanolic ammonia, gave (+)-amygdalin, VII, which was shown to be identical with the natural compound. (See overleaf.)

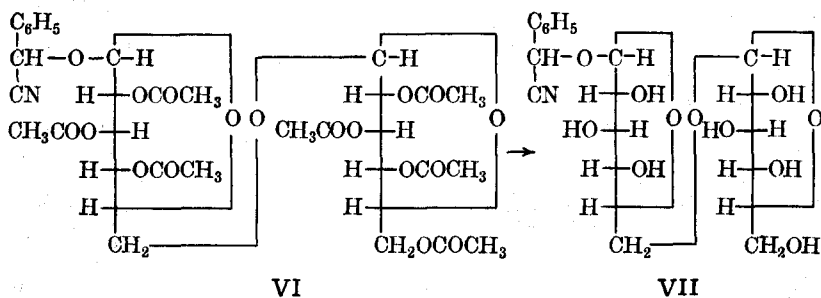
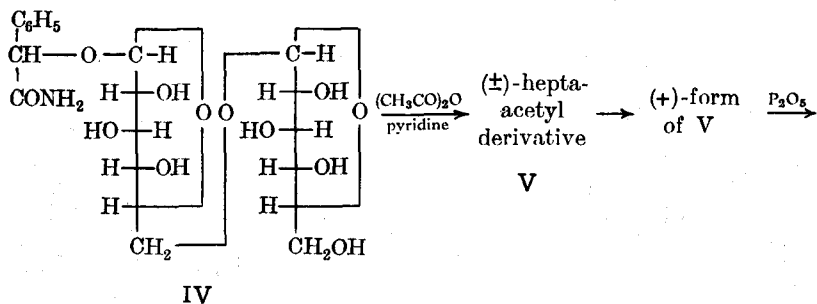
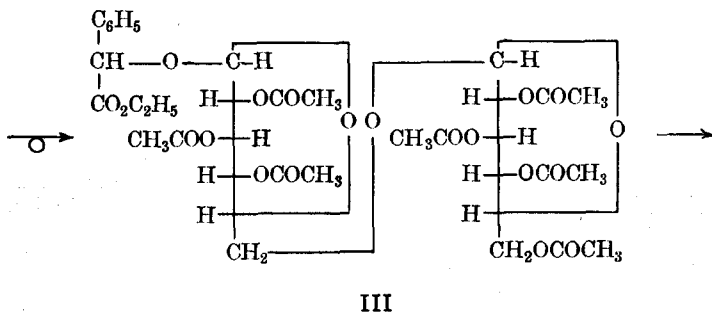
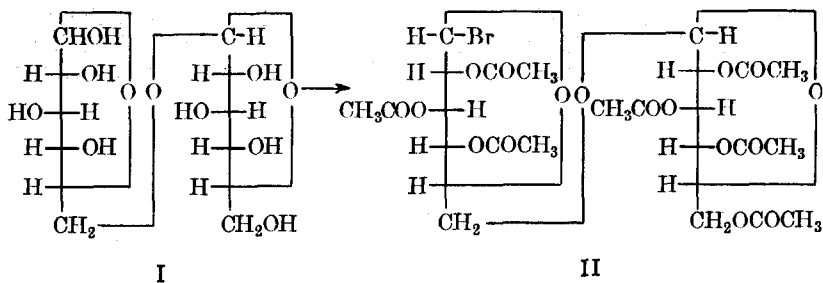

**§28. Arbutin and Methylarbutin.** Arbutin is hydrolysed by emulsin to give one molecule of D-glucose and one of quinol; thus arbutin is a  $\beta$ -glucoside. When methylated (with methyl sulphate in the presence of sodium hydroxide), arbutin forms pentamethylarbutin, and this on hydrolysis with methanolic hydrogen chloride, gives methyl 2 : 3 : 4 : 6-tetra-O-methyl-D-glucoside and monomethylquinol (Macbeth *et al.*, 1923); structure I for arbutin accounts for all these facts.



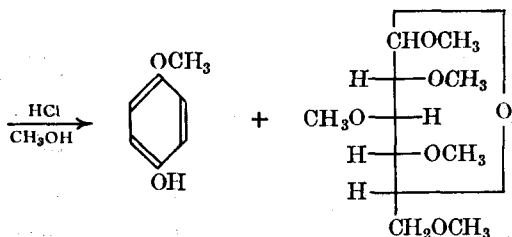
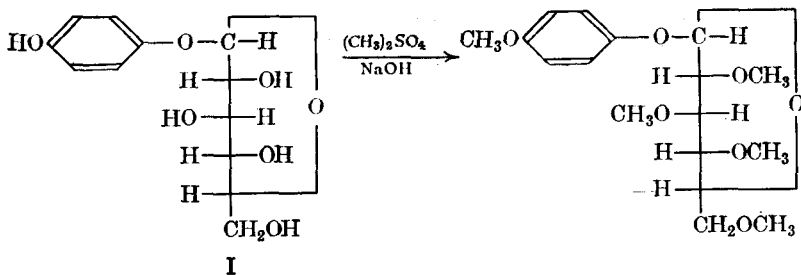

Pentamethylarbutin has been synthesised by converting 2 : 3 : 4 : 6-tetra-*O*-methyl-*D*-glucose into tetra-*O*-methyl- $\alpha$ -*D*-glucopyranosyl 1-bromide, and condensing this with monomethylquinol; the product is identical with the methylated natural compound.

**Methylarbutin.** This is hydrolysed by emulsin to one molecule of *D*-glucose and one molecule of monomethylquinol; thus methylarbutin is a  $\beta$ -glucoside, and its structure is:

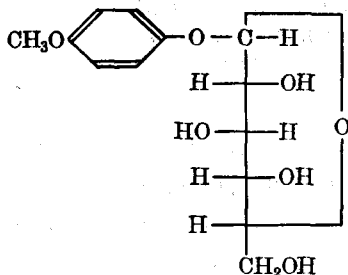

Methylarbutin has been synthesised by condensing tetra-*O*-acetyl- $\alpha$ -*D*-glucopyranosyl 1-bromide with monomethylquinol in the presence of silver carbonate, followed by de-acetylation.

**§29. Salicin.** This is hydrolysed by emulsin to one molecule of *D*-glucose and one of salicyl alcohol (saligenin). Thus salicin is a  $\beta$ -glucoside, but it is not possible to tell from the hydrolytic products whether it is the phenolic or alcoholic group of the salicyl alcohol which forms the glycosidic link. Which group is involved is readily shown as follows (Irvine *et al.*, 1906). Oxidation of salicin with nitric acid forms *helicin*, and this, on hydrolysis, gives glucose and salicylaldehyde. Thus the phenolic group in salicyl alcohol must form the glucoside. Methylation of salicin produces pentamethylsalicin, and this, on hydrolysis, gives 2 : 3 : 4 : 6-tetra-*O*-methyl-*D*-glucose. Hence the glucose residue is in the pyranose form; the structure given for salicin fits the foregoing facts. This structure has been confirmed by condensing tetra-*O*-methyl- $\alpha$ -*D*-glucopyranosyl 1-bromide with salicyl alcohol,

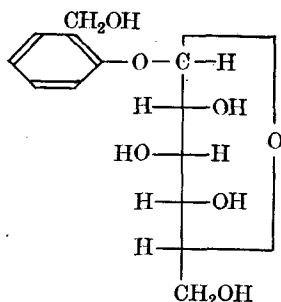

and then methylating the product. The pentamethylsalicin so obtained was identical with the methylated natural product (Irvine *et al.*, 1906).

§30. **Sinigrin.** This glycoside occurs in black mustard seed, and on hydrolysis with the enzyme myrosin, D-glucose, allyl isothiocyanate and potassium hydrogen sulphate are obtained.

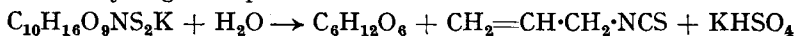

Sodium methoxide degrades sinigrin, and one of the products obtained is thioglucose,  $\text{C}_6\text{H}_{11}\text{O}_5\cdot\text{SH}$ . From this it is inferred that the glucose residue is linked to a sulphur atom in sinigrin. Gadamer (1897) proposed I for the

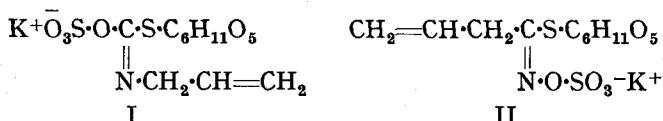

structure of sinigrin, but Ettlinger *et al.* (1956) have proposed II, since these authors have shown that allyl isothiocyanate is produced by rearrangement when the glycoside is hydrolysed by myrosin (*cf.* the Lossen rearrangement; see Vol. I).

#### READING REFERENCES

- Handbook for Chemical Society Authors*, Chemical Society (1960). Ch. 5. Nomenclature of Carbohydrates.
- Rosanoff, On Fischer's Classification of Stereoisomers, *J. Amer. Chem. Soc.*, 1906, **28**, 114.
- Haworth, *The Constitution of Sugars*, Arnold (1929).
- Honeyman, *Chemistry of the Carbohydrates*, Oxford Press (1948).
- Percival, *Structural Carbohydrate Chemistry*, Muller (2nd ed., 1962).
- Pigman and Goepf, *Chemistry of the Carbohydrates*, Academic Press (1948).
- Gilman (Ed.), *Advanced Organic Chemistry*, Wiley. (i) Vol. II (1943, 2nd ed.). Ch. 20, 21. Carbohydrates. Ch. 22. Cellulose. (ii) Vol. IV (1953). Ch. 9. Starch.
- Percival, Carbohydrate Sulphates, *Quart. Reviews (Chem. Soc.)*, 1949, **3**, 369.
- Barker and Bourne, Enzymic Synthesis of Polysaccharides, *Quart. Reviews (Chem. Soc.)*, 1953, **7**, 56.
- Hudson, Emil Fischer's Discovery of the Configuration of Glucose, *J. Chem. Educ.*, 1941, **18**, 353.
- Advances in Carbohydrate Chemistry*, Academic Press (1945-).
- Manners, The Enzymic Degradation of Polysaccharides, *Quart. Reviews (Chem. Soc.)*, 1955, **9**, 73.
- Sir Robert Robinson, *The Structural Relationships of Natural Products*, Oxford Press (1955).
- Downes, *The Chemistry of Living Cells*, Longmans, Green (2nd ed., 1963).
- Newth, Sugar Epoxides, *Quart. Reviews (Chem. Soc.)*, 1959, **13**, 30.
- Ferrier and Overend, Newer Aspects of the Stereochemistry of Carbohydrates, *Quart. Reviews (Chem. Soc.)*, 1959, **13**, 265.
- Sunderwirth and Olson, Conformational Analysis of the Pyranoside Ring, *J. Chem. Educ.*, 1962, **39**, 410.

- Manners, Structural Analysis of Polysaccharides, *Roy. Inst. Chem.*, Lectures, Monographs and Reports, 1959, No. 2.
- Wiggins, Sugar and its Industrial Applications, *Roy. Inst. Chem.*, Lectures, Monographs and Reports, 1960, No. 5.
- Bassham, Photosynthesis, *J. Chem. Educ.*, 1959, **36**, 548.
- Park, Advances in Photosynthesis, *J. Chem. Educ.*, 1962, **39**, 424.
- Arnon *et al.*, Photoproduction of Hydrogen, Photofixation of Nitrogen and a Unified Concept of Photosynthesis, *Nature*, 1961, **192**, 601.
- Roderick, Structural Variety of Natural Products, *J. Chem. Educ.*, 1962, **39**, 2.

CHAPTER VIII

TERPENES

§1. **Introduction.** The terpenes form a group of compounds the majority of which occur in the plant kingdom; a few terpenes have been obtained from other sources. The simpler mono- and sesqui-terpenes are the chief constituents of the essential oils; these are the volatile oils obtained from the sap and tissues of certain plants and trees. The essential oils have been used in perfumery from the earliest times. The di- and tri-terpenes, which are not steam volatile, are obtained from plant and tree gums and resins. The tetraterpenes form a group of compounds known as the *carotenoids*, and it is usual to treat these as a separate group (see Ch. IX). Rubber is the most important polyterpene.

Most natural terpene hydrocarbons have the molecular formula  $(C_5H_8)_n$ , and the value of  $n$  is used as a basis of classification. Thus we have the following classes (these have already been mentioned above):

- |  |                                       |
|--|---------------------------------------|
| (i) Monoterpenes, $C_{10}H_{16}$ .                             | (ii) Sesquiterpenes, $C_{15}H_{24}$ . |
| (iii) Diterpenes, $C_{20}H_{32}$ .                             | (iv) Triterpenes, $C_{30}H_{48}$ .    |
| (v) Tetraterpenes, $C_{40}H_{64}$ (these are the carotenoids). |                                       |
| (vi) Polyterpenes, $(C_5H_8)_n$ .                              |                                       |

In addition to the terpene hydrocarbons, there are the oxygenated derivatives of each class which also occur naturally, and these are mainly alcohols, aldehydes or ketones.

The term *terpene* was originally reserved for those hydrocarbons of molecular formula  $C_{10}H_{16}$ , but by common usage, the term now includes all compounds of the formula  $(C_5H_8)_n$ . There is, however, a tendency to call the whole group *terpenoids* instead of *terpenes*, and to restrict the name *terpene* to the compounds  $C_{10}H_{16}$ .

The thermal decomposition of almost all terpenes gives isoprene as one of the products, and this led to the suggestion that the skeleton structures of all naturally occurring terpenes can be built up of isoprene units; this is known as the **isoprene rule**, and was first pointed out by Wallach (1887). Thus the divisibility into isoprene units may be regarded as a necessary condition to be satisfied by the structure of any plant-synthesised terpene. Furthermore, Ingold (1925) pointed out that the isoprene units in natural terpenes were joined "head to tail" (the head being the branched end of isoprene). This divisibility into isoprene units, and their head to tail union, may conveniently be referred to as the *special isoprene rule*. It should be noted, however, that this rule, which has proved very useful, can only be used as a guiding principle and not as a fixed rule. Several exceptions to it occur among the simpler terpenes, *e.g.*, lavandulol is composed of two isoprene units which are not joined head to tail; also, the carotenoids are joined tail to tail at their centre (see Ch. IX).

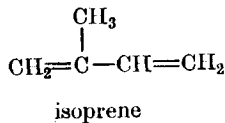
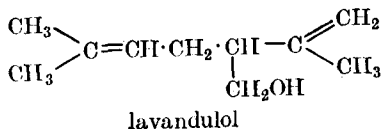

The carbon skeletons of open-chain monoterpenes and sesquiterpenes are:

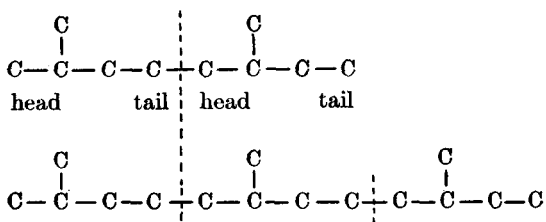

Monocyclic terpenes contain a six-membered ring, and in this connection Ingold (1921) pointed out that a *gem*-dialkyl group tends to render the cyclohexane ring unstable. Hence, in closing the open chain to a cyclohexane ring, use of this "*gem*-dialkyl rule" limits the number of possible structures (but see, *e.g.*, abietic acid, §31). Thus the monoterpene open chain can give rise to only *one* possibility for a monocyclic monoterpene, *viz.*, the *p*-cymene structure. This is shown in the following structures, the acyclic structure being written in the conventional "ring shape".

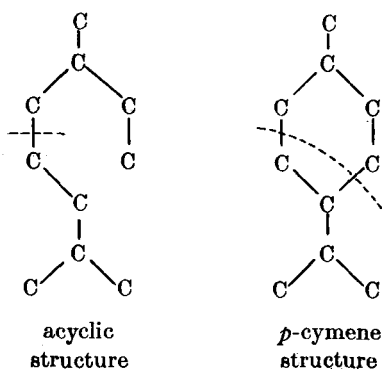

All natural monocyclic monoterpenes are derivatives of *p*-cymene.

Bicyclic monoterpenes contain a six-membered ring and a three-, four- or five-membered ring. Ingold (1921) also pointed out that cyclopropane and cyclobutane rings require the introduction of a *gem*-dimethyl group to render them sufficiently stable to be capable of occurrence in nature. Thus closure of the C<sub>10</sub> open chain gives three possible bicyclic structures; all three types are known.

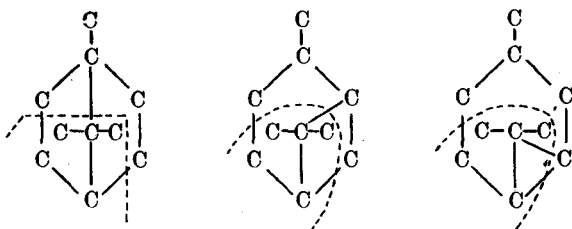

If we use these ideas with the sesquiterpene acyclic structure, then we find that only three monocyclic and three bicyclic structures are possible (not all are known; see the sesquiterpenes).

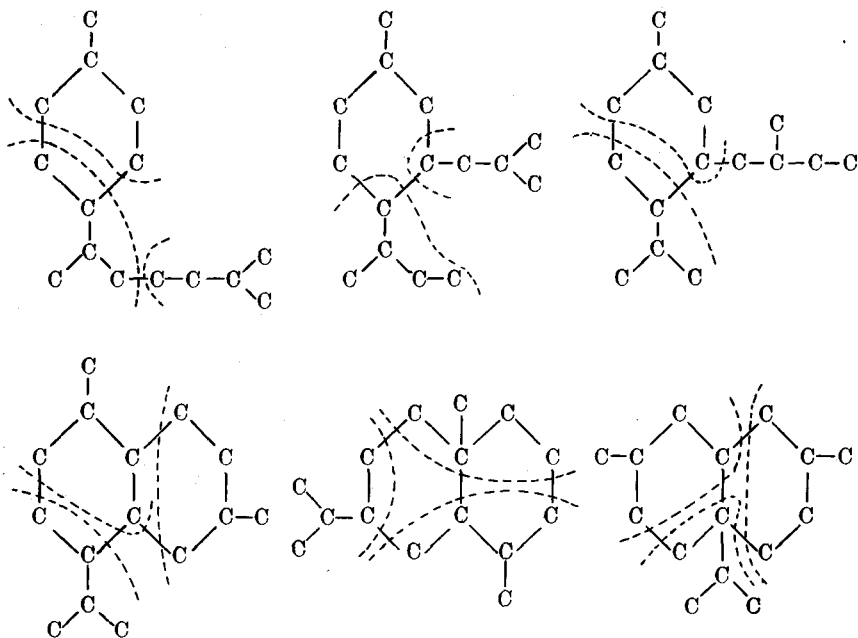

Recently some furano-terpenes have been isolated, *e.g.*, dendrolasin, which is believed to have the following structure (Quilico *et al.*, 1957); it contains three isoprene units joined head to tail.

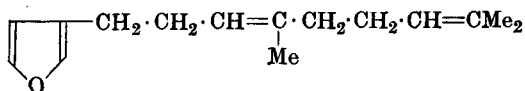

**§2. Isolation of monoterpenes and sesquiterpenes.** Plants containing essential oils usually have the greatest concentration at some particular time, *e.g.*, jasmine at sunset. In general, there are four methods of extraction of the terpenes: (i) expression; (ii) steam distillation; (iii) extraction by means of volatile solvents; (iv) adsorption in purified fats (*enfleurage*). Method (ii) is the one most widely used; the plant is macerated and then steam distilled. If the compound decomposes under these conditions, it may be extracted with light petrol at  $50^\circ$ , and the solvent then removed by distillation under reduced pressure. Alternatively, the method of adsorption in fats is used. The fat is warmed to about  $50^\circ$ , and then the flower petals are spread on the surface of the fat until the latter is saturated. The fat is now digested with ethanol, any fat that dissolves being removed by cooling to  $20^\circ$ . The essential oils so obtained usually contain a number of terpenes, and these are separated by fractional distillation. The terpene hydrocarbons distil first, and these are followed by the oxygenated derivatives. Distillation of the residue under reduced pressure gives the sesquiterpenes, and these are separated by fractional distillation.

**§3. General methods of determining structure.** The following brief account gives an indication of the various methods used in elucidating the structures of the terpenes (see the text for details).

(i) A pure specimen is obtained, and the molecular formula is ascertained by the usual methods. If the terpene is optically active, its specific rotation

is measured. Optical activity may be used as a means of distinguishing structures (see, *e.g.*, §12).

(ii) If oxygen is present in the molecule, its functional nature is ascertained, *i.e.*, whether it is present as hydroxyl, aldehyde, ketone, etc. (*cf.* alkaloids, §4. XIV).

(iii) The presence of olefinic bonds is ascertained by means of bromine, and the number of double bonds is determined by analysis of the bromide, or by quantitative hydrogenation, or by titration with monoperphthalic acid. These facts lead to the molecular formula of the parent hydrocarbon, from which the number of rings present in the structure may be deduced.

(iv) The preparation of nitrosochlorides and a study of their behaviour (see also the nitroso compounds, Vol. I).

(v) Dehydrogenation of terpenes with sulphur or selenium, and an examination of the products thereby obtained (see also §2 vii. X).

(vi) Measurement of the refractive index leads to a value for the molecular refractivity. From this may be deduced the nature of the carbon skeleton (see, in particular, sesquiterpenes). Also, optical exaltation indicates the presence of double bonds in conjugation (*cf.* §11. I).

(vii) Measurement of the ultraviolet, infra-red and Raman spectra. More recently X-ray analysis of crystals has also been used.

(viii) Degradative oxidation. The usual reagents used for this purpose are ozone, acid or alkaline permanganate, chromic acid and sodium hypobromite. In general, degradative oxidation is the most powerful tool for elucidating the structures of the terpenes.

(ix) After the analytical evidence has led to a tentative structure (or structures), the final proof of structure depends on synthesis. In terpene chemistry, many of the syntheses are ambiguous, and in such cases analytical evidence is used in conjunction with the synthesis. Many terpenes have not yet been synthesised.

### MONOTERPENES

The monoterpenes may be subdivided into three groups: acyclic, monocyclic and bicyclic. This classification affords a convenient means of study of the monoterpenes.

#### ACYCLIC MONOTERPENES

§4. **Myrcene**,  $C_{10}H_{16}$ , is an acyclic monoterpene hydrocarbon which occurs in verbena and bay oils. It is a liquid, b.p. 166–168°. Catalytic hydrogenation (platinum) converts myrcene into a decane,  $C_{10}H_{22}$ ; thus myrcene contains three double bonds, and is an open-chain compound. Furthermore, since myrcene forms an adduct with maleic anhydride, two of the double bonds are conjugated (Diels *et al.*, 1929; see the Diels–Alder reaction, Vol. I). This conjugation is supported by evidence obtained from the ultraviolet spectrum of myrcene (Booker *et al.*, 1940). These facts, *i.e.*, that myrcene contains three double bonds, two of which are in conjugation, had been established by earlier investigators (*e.g.*, Semmler, 1901). Ozonolysis of myrcene produces acetone, formaldehyde and a ketodialdehyde,  $C_5H_8O_3$ , and the latter, on oxidation with chromic acid, gives succinic acid and carbon dioxide (Ruzicka *et al.*, 1924). These results can be explained by assigning structure I to myrcene. In terpene chemistry it has become customary to use conventional formulæ rather than those of the type I. In these conventional formulæ only lines are used; carbon atoms are at the junctions of pairs of lines or at the end of a line, and unsaturation is indicated by double bonds. Furthermore, the carbon skeleton is usually

drawn in a ring fashion (the *cyclohexane* ring). Thus myrcene may be represented as II, and this type of structural formula will, in general, be

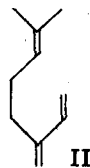
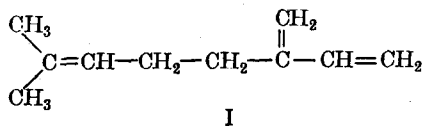

used in this book. Thus the process of ozonolysis and oxidation of the ketodialdehyde may be written:

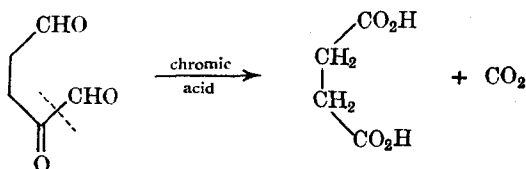
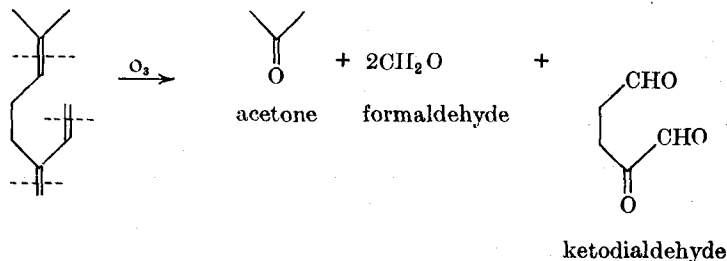

This structure for myrcene is supported by the fact that on hydration (under the influence of sulphuric acid), myrcene forms an alcohol which, on oxidation, gives citral. The structure of this compound is known (see §5), and its formation is in accord with the structure given to myrcene.

§4a. **Ocimene**, C<sub>10</sub>H<sub>16</sub>, b.p. 81°/30 mm. When catalytically hydrogenated, ocimene adds on three molecules of hydrogen to form a decane. Thus ocimene is an acyclic compound which contains three double bonds. Furthermore, since ocimene forms an adduct with maleic anhydride, two of the double bonds are conjugated. On ozonolysis, ocimene produces formaldehyde, methylglyoxal, lævulaldehyde, acetic and malonic acids, and some acetone. All of these products, except acetone, are accounted for by structure I for ocimene (this has an *isopropenyl* end-group). In order to account for the appearance of acetone in the oxidation products, ocimene

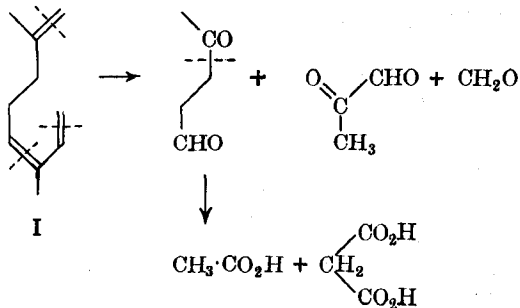



is also believed to exist in the *isopropylidene* form, II, *i.e.*, ocimene is a mixture of I and II, with I predominating (but see citral, §5).

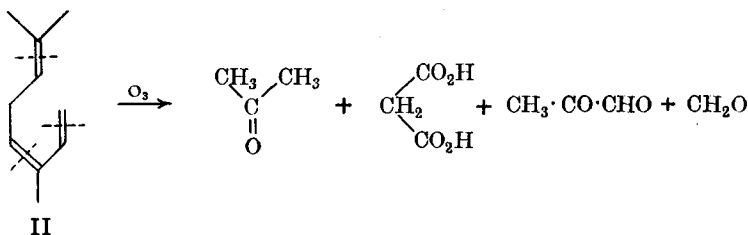

§5. **Citral**,  $C_{10}H_{16}O$ . This is the most important member of the acyclic monoterpenes, since the structures of most of the other compounds in this group are based on that of citral. Citral is widely distributed and occurs to an extent of 60–80 per cent. in lemon grass oil. Citral is a liquid which has the smell of lemons.

Citral was shown to contain an oxo group, *e.g.*, it forms an oxime, etc. On heating with potassium hydrogen sulphate, citral forms *p*-cymene, II (Semmler, 1891). This reaction was used by Semmler to determine the positions of the methyl and *isopropyl* groups in citral; Semmler realised that the citral molecule was acyclic, and gave it the skeleton structure, I (two

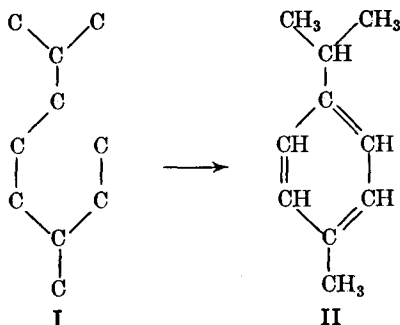

isoprene units joined head to tail). Citral can be reduced by sodium amalgam to an alcohol, geraniol,  $C_{10}H_{18}O$ , and is oxidised by silver oxide to geranic acid,  $C_{10}H_{16}O_2$ ; since there is no loss of carbon on oxidation to the acid, the oxo group in citral is therefore an aldehyde group (Semmler, 1890). Oxidation of citral with alkaline permanganate, followed by chromic acid, gives acetone, oxalic and lævulic acids (Tiemann and Semmler, 1895). Thus, if citral has structure III, the formation of these oxidation products may be

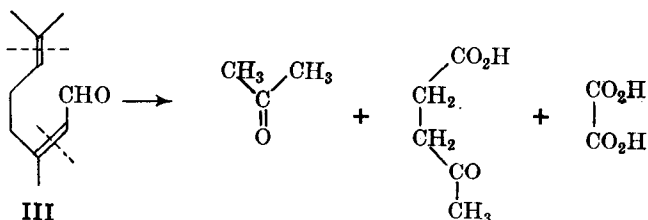

accounted for. This structure is supported by the work of Verley (1897), who found that aqueous potassium carbonate converted citral into 6-methylhept-5-en-2-one, IV, and acetaldehyde. The formation of these products

is readily explained by assuming III undergoes cleavage at the  $\alpha : \beta$ -double bond; this cleavage by alkaline reagents is a general reaction of  $\alpha : \beta$ -unsaturated oxo compounds (see Vol. I). Furthermore, methylheptenone itself is also oxidised to acetone and lævulic acid; this is again in accord with

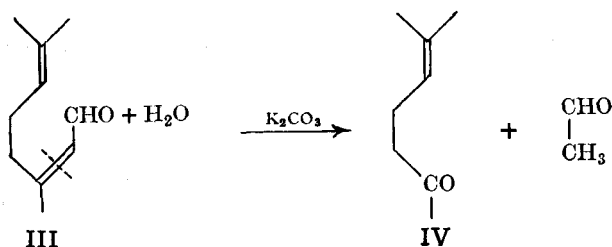

structure III. The structure of methylheptenone was already known from its synthesis by Barbier and Bouveault (1896). These workers condensed 2 : 4-dibromo-2-methylbutane with sodio-acetylacetone, and heated the resulting compound with concentrated sodium hydroxide solution. Barbier

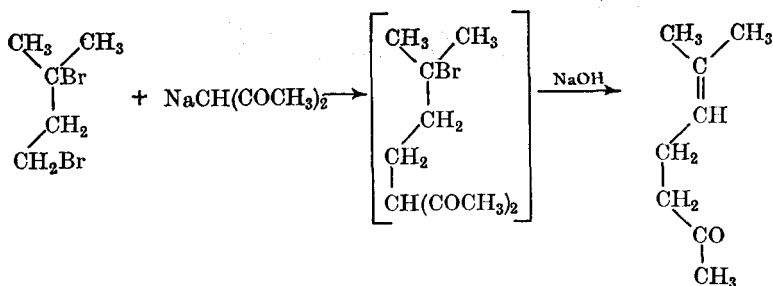

and Bouveault (1896) then converted methylheptenone into geranic ester, V, by means of the Reformatsky reaction, using zinc and ethyl iodoacetate. The synthesis of citral was completed by Tiemann (1898) by distilling a

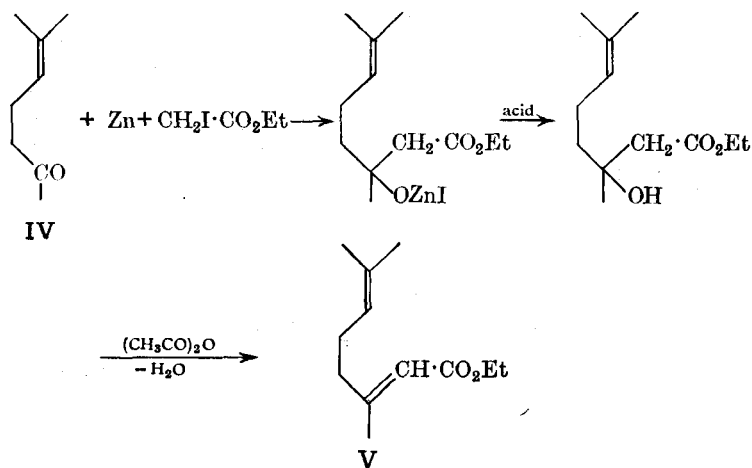

mixture of the calcium salts of geranic and formic acids (*ca* represents "half an atom of calcium"):

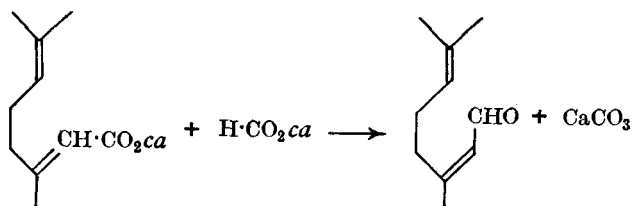

A more recent synthesis of citral is that of Arens and van Dorp (1948). Methylheptenone was first prepared as follows:

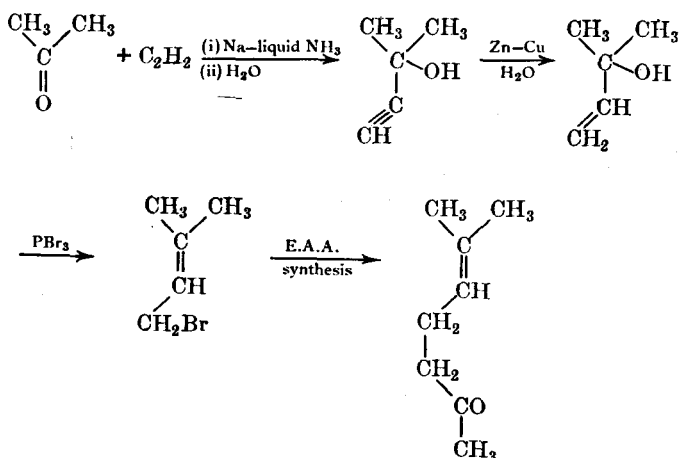

Then the methylheptenone was treated with ethoxyacetylene-magnesium bromide, the product reduced and then de-alkylated. It should be noted

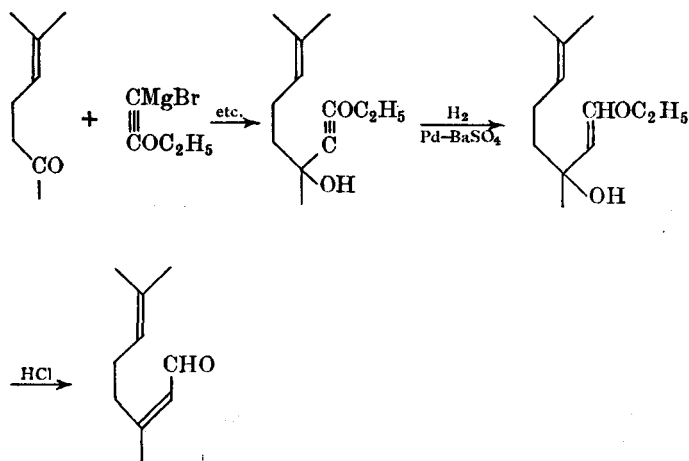

that an *allylic rearrangement* occurs in both parts of this synthesis (see also §8). Ethoxyacetylenemagnesium bromide may conveniently be prepared from chloroacetaldehyde diethyl acetal as follows (Jones *et al.*, 1954):

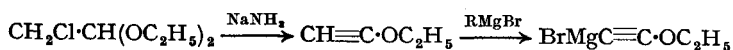

Examination of the formula of citral shows that two geometrical isomers are possible:

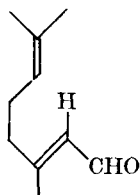

*trans*-form;  
citral-*a*;  
geranial

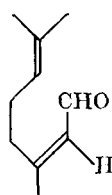

*cis*-form;  
citral-*b*;  
neral

Both isomers occur in natural citral, *e.g.*, two semicarbazones are formed by citral; both forms of citral itself have also been obtained: **citral-a** (also known as *geranial*) has a b.p. 118–119°/20 mm., and **citral-b** (also known as *neral*) has a b.p. 117–118°/20 mm. The configurations of these two forms have been determined from a consideration of the ring closures of the corresponding alcohols (see geraniol, §7).

The problem of the structure of citral is further complicated for the following reasons. Ozonolysis of citral gives acetone, lævulaldehyde and glyoxal (Harries, 1903, 1907); these products are to be expected from structure III. On the other hand, Grignard *et al.* (1924) also isolated a small amount of formaldehyde from the products of ozonolysis; this points towards structure VI, which has an *isopropenyl* end-group. Thus citral

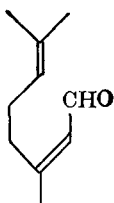

III

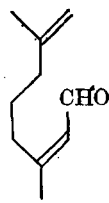

VI

has been regarded as a mixture of *four* substances, two *geranials* and two *nerals*. Assuming, then, that both the *isopropylidene* and *isopropenyl* forms are present, it is possible that these two structures form a three-carbon tautomeric system:

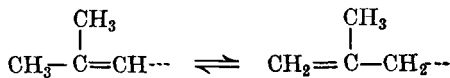

Recent work, however, has cast doubt on the existence of these two forms in citral. According to infra-red spectroscopic studies, it appears that naturally occurring acyclic monoterpenes as a class possess only the *isopropylidene* end-group structure (Barnard, Bateman *et al.*, 1950). According to these authors, *during oxidative degradation*, partial rearrangement from the *isopropylidene* to the *isopropenyl* structure occurs, and so this method of determining fine structure is unreliable (see also geraniol, §7). Oliver (1961) has developed a chemical together with a chromatographic

method for separating a mixture of *isopropylidene* and *isopropenyl* isomers. This should be of value in the studies of natural terpenes.

**§6. Ionones.** When citral is condensed with acetone in the presence of barium hydroxide,  $\psi$ -ionone is formed and this, on heating with dilute sulphuric acid in the presence of glycerol, forms a mixture of  $\alpha$ - and  $\beta$ -ionones (Tiemann and Krüger, 1893). The proportion of  $\alpha$  to  $\beta$  varies with the nature of the cyclising agent used, *e.g.*, with sulphuric acid,  $\beta$ -ionone is the main product; with phosphoric acid,  $\alpha$ -ionone is the main product. Both ionones have been obtained from natural sources; the  $\beta$ -isomer is optically inactive, whereas the  $\alpha$ -isomer can exist in optically active forms

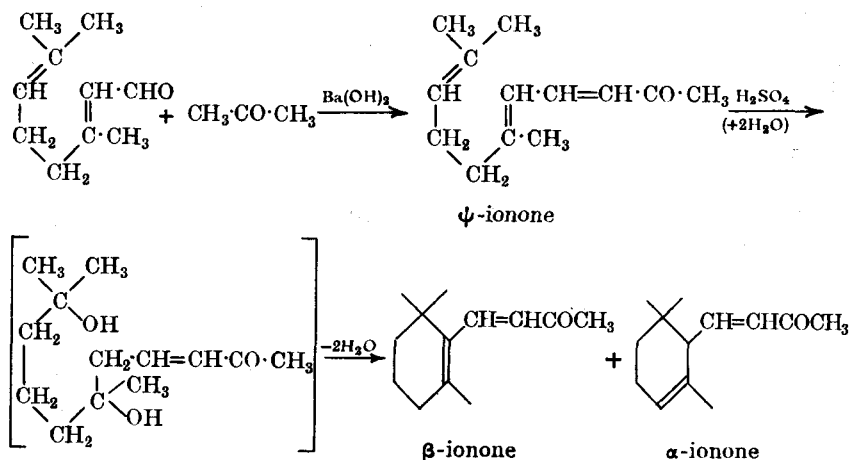

since it contains one asymmetric carbon atom. Actually, the (+)-, (-) and ( $\pm$ )-forms of  $\alpha$ -ionone occur naturally. Very dilute ethanolic solutions of  $\beta$ -ionone have the odour of violets.

The structures of the ionones were established by a study of the oxidation products produced by potassium permanganate (Tiemann, 1898, 1900);

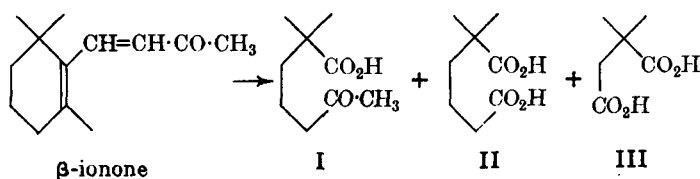

$\beta$ -ionone gave geronic acid, I,  $\alpha$ : $\alpha$ -dimethyladipic acid, II, and  $\alpha$ : $\alpha$ -dimethylsuccinic acid, III. On the other hand,  $\alpha$ -ionone gave a mixture of isogeronic acid, IV,  $\beta$ : $\beta$ -dimethyladipic acid, V, and  $\alpha$ : $\alpha$ -dimethylglutaric acid, VI.

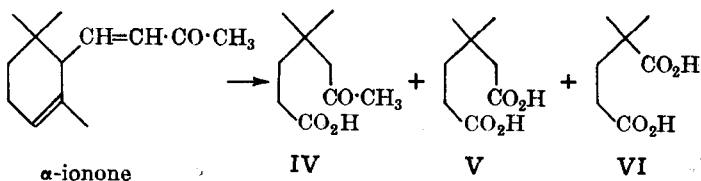

Theimer *et al.* (1962) have isolated  $\gamma$ -ionone (by vapour-phase chromato-

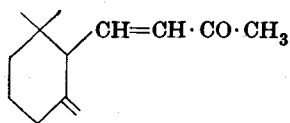

graphy) from the mixture of ionones obtained above (this ionone corresponds to the  $\gamma$ -irone; see below).

The ionones are related to **irone**,  $C_{14}H_{22}O$ ; this occurs in the oil obtained from the orris root. The structure of irone was established by Ruzicka *et al.* (1947), who showed that on ozonolysis, irone gives formaldehyde and  $\beta : \beta : \gamma$ -trimethylpimelic acid, VIII; also, reduction of irone with hydriodic acid and red phosphorus, followed by dehydrogenation with selenium, gives 1 : 2 : 6-trimethylnaphthalene, IX. Ruzicka therefore proposed structure

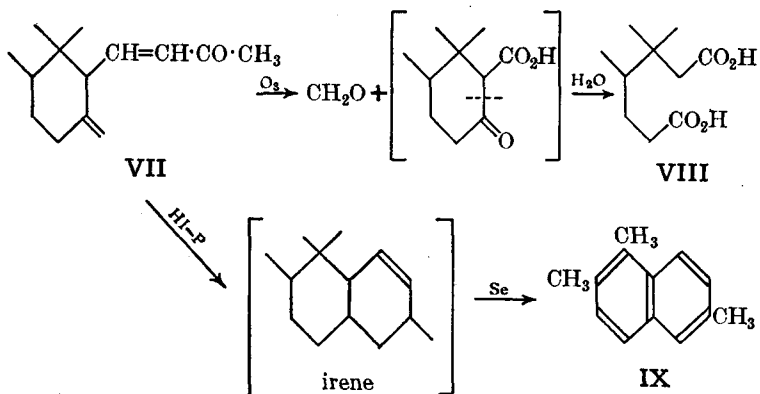

VII for irone. Ruzicka (1947) further showed that irone was a mixture of three isomers (VII is  $\gamma$ -irone):

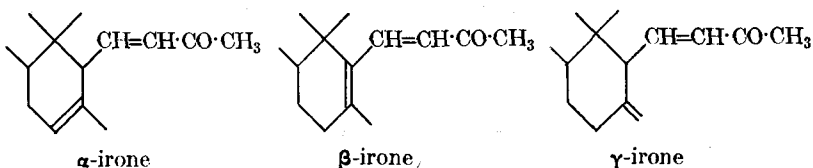

**§7. Geraniol**,  $C_{10}H_{18}O$ , b.p. 229–230°/757 mm. This is found in many essential oils, particularly rose oil. Geraniol was shown to be a primary alcohol, *e.g.*, on oxidation it gives an aldehyde (citral-*a*); and since it forms a tetrabromide, geraniol therefore contains two double bonds. Reduction of citral produces geraniol, but at the same time some nerol is formed. The *structural* identity of geraniol and nerol is shown by the following facts. Both add on two molecules of hydrogen when hydrogenated catalytically; thus both contain two double bonds. Both give the same saturated alcohol,  $C_{10}H_{22}O$ . Also, on oxidation, geraniol and nerol give the same oxidation products which, at the same time, show the positions of the double bonds to be 2 and 7 (*cf.* citral, §5). Thus geraniol and nerol are geometrical isomers. Geraniol has been assigned the *trans* configuration and nerol the *cis* on the fact that cyclisation to  $\alpha$ -terpineol (§11) by means of dilute sulphuric acid takes place about 9 times as fast with nerol as it does with geraniol;

this faster rate with nerol is due to the proximity of the alcoholic group to the carbon (\*) which is involved in the ring formation. Thus:

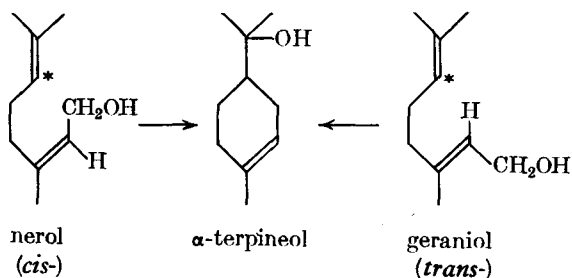

Nerol also occurs naturally in various essential oils, *e.g.*, oil of neroli, bergamot, etc.; its b.p. is 225–226°.

Knights *et al.* (1955) have found that, on ozonolysis, geranyl acetate gives less than 3 per cent. of formaldehyde, and have concluded that the acetate and geraniol itself have predominantly the *isopropylidene* structure (*cf.* citral, §5).

§8. **Linalool**,  $C_{10}H_{18}O$ , b.p. 198–199°. This is an optically active compound; the (–)-form occurs in rose oil and the (+)-form in orange oil. It was shown to be a tertiary alcohol, and since it adds on two molecules of hydrogen on catalytic hydrogenation, it must contain two double bonds. When heated with acetic anhydride, linalool is converted into geranyl acetate; and the latter is converted into the former by heating with steam at 200° under pressure. Also, heating linalool with hydrogen chloride in toluene solution at 100° produces geranyl chloride, and this, when treated with moist silver oxide in benzene solution, is reconverted into linalool. These reactions are parallel to those which occur when crotyl alcohol is treated with hydrogen bromide; a mixture of crotyl bromide and methylvinylcarbinyl bromide is obtained. When *either* of these products is treated with moist silver oxide, a mixture of crotyl alcohol and methylvinylcarbinol is obtained.

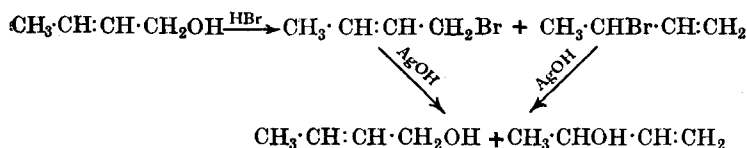

Thus the elucidation of the structure of linalool is complicated by the ease with which the *allylic rearrangement* occurs (see also Vol. I). Since the structure of geraniol is known, a possible structure for linalool is obtained on the basis of this allylic rearrangement.

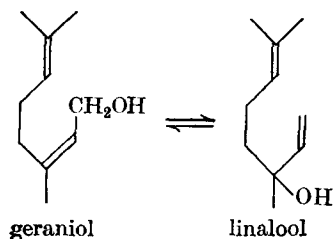

This structure has been confirmed by synthesis of linalool (Ruzicka *et al.*, 1919); 6-methylhept-5-en-2-one was treated as follows:

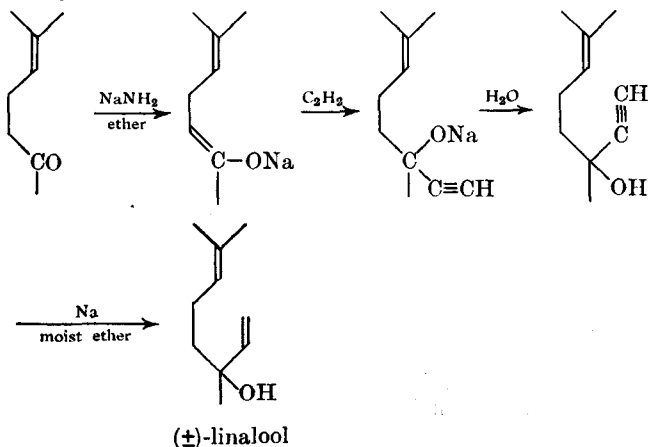

Normant (1955) has synthesised linalool in one step by the action of vinylmagnesium bromide on methylheptenone.

§9. **Citronellal**,  $C_{10}H_{18}O$ . This is an optically active compound which occurs in citronella oil. Citronellal is an aldehyde; reduction with sodium amalgam converts it into the alcohol citronellol,  $C_{10}H_{20}O$ , and oxidation gives citronellic acid,  $C_{10}H_{18}O_2$ . Now there is another aldehyde, **rhodinal**, which is isomeric with citronellal, and on reduction, rhodinal gives the alcohol, rhodinol, which is isomeric with citronellol. Furthermore, reduction of ethyl geranate with sodium and ethanol gives rhodinol (Bouveault *et al.*, 1900).

Oxidation of citronellal with chromic acid gives  $\beta$ -methyladipic acid and acetone (Tiemann *et al.*, 1896, 1897). Rhodinal also gives the *same* products

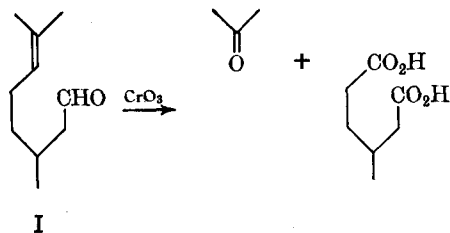

on oxidation. Thus structure I would fit the facts for both citronellal and rhodinal. On the other hand, ozonolysis of citronellal gives  $\beta$ -methyladipic acid, acetone and some formaldehyde (Harries *et al.*, 1908). These results point towards structure II for citronellal, as well as I. Thus citronellal appears to be a mixture of I (*isopropylidene* end-group) and II (*isopropenyl* end-group). Furthermore, a detailed study of rhodinal has shown that this

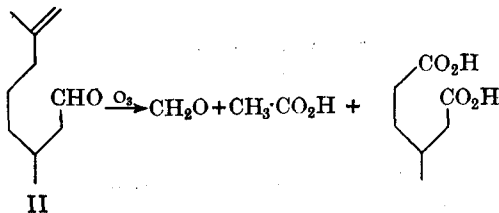



compound is identical with citronellal, but consists of a mixture of the two forms in different proportions (but *cf.* citral, §5).

§9a. **Citronellol and Rhodinol,  $C_{10}H_{20}O$ .** (–)-Citronellol occurs in rose and geranium oils, and is a mixture of the two forms:

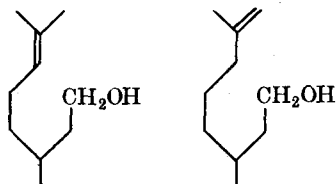

The (+)-form of citronellol is made commercially by reduction of citronellal with sodium or aluminium amalgam; it also occurs in Java citronella oil.

Rhodinol is identical with citronellol, but the proportions of the two forms are different from those which occur in citronellol; the identity of citronellol and rhodinol is shown by the products of ozonolysis.

### MONOCYCLIC MONOTERPENES

§10. **Nomenclature.** For the purposes of nomenclature of the monocyclic monoterpenes, the fully saturated compound *p*-methylisopropylcyclohexane, hexahydro-*p*-cymene or *p*-menthane,  $C_{10}H_{20}$ , is used as the parent substance; it is a synthetic compound, b.p.  $170^{\circ}$ . *p*-Menthane is I, and II is a conventional method of drawing formula I. The positions of substituents and double bonds are indicated by numbers 1, the method of numbering being shown in I (and II). When a compound derived from *p*-menthane

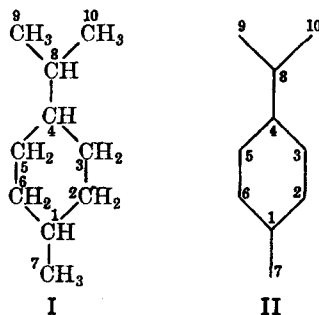

contains one or more double bonds, ambiguity may arise as to the position of a double bond when this is indicated in the usual way by a number which locates the *first* carbon atom joined by the double bond. To prevent ambiguity, the *second* carbon atom joined to the double bond is also shown,



$\Delta^2$ -*p*-menthene;  
2-*p*-menthene;  
*p*-menth-2-ene;  
*p*-menthene-2.



*p*-menth-  
1(7)-ene



*p*-mentha-  
1:4(8)-diene

but is placed in parentheses. The previous examples illustrate the method of nomenclature; in the first example, all the types of methods of nomenclature have been given; in the second and third examples, only the nomenclature that will be used in this book is given.

**§11a.  $\alpha$ -Terpineol.** This is an optically active monoterpene that occurs naturally in the (+), (-) and ( $\pm$ )-forms; it is a solid, m.p. (of the racemic modification)  $35^\circ$ . The molecular formula of  $\alpha$ -terpineol is  $C_{10}H_{18}O$ , and the oxygen atom is present as a tertiary alcoholic group (as shown by the reactions of  $\alpha$ -terpineol). Since  $\alpha$ -terpineol adds on two bromine atoms, it therefore contains one double bond. Thus the parent (saturated) hydrocarbon of  $\alpha$ -terpineol has the molecular formula  $C_{10}H_{20}$ . This corresponds to  $C_nH_{2n}$ , the general formula of the (monocyclic) *cyclo*alkanes, and so it follows that  $\alpha$ -terpineol is a monocyclic compound.

When heated with sulphuric acid,  $\alpha$ -terpineol forms some *p*-cymene. Taking this in conjunction with the tentative proposal that  $\alpha$ -terpineol is monocyclic, it is reasonable to infer that  $\alpha$ -terpineol contains the *p*-cymene skeleton. Thus we may conclude that  $\alpha$ -terpineol is probably *p*-menthane with one double bond and a tertiary alcoholic group. The positions of these functional groups were ascertained by Wallach (1893, 1895) by means of *graded* oxidation. The following chart gives the results of Wallach's work; only the carbon content is indicated to show the fate of these carbon atoms (the formulæ are given in the text).

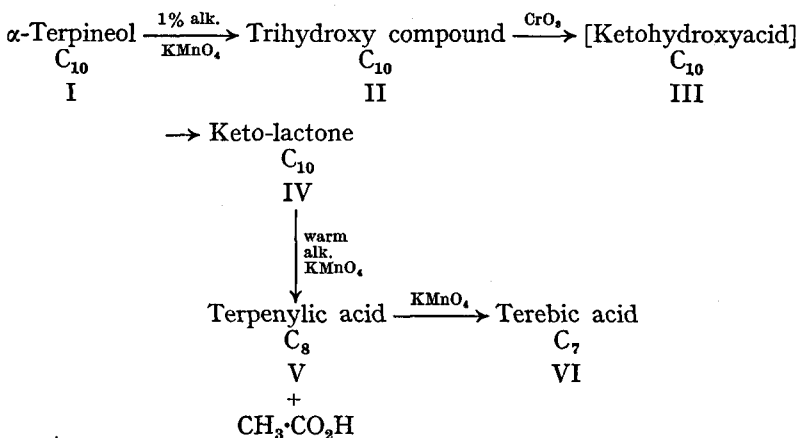

Oxidation of  $\alpha$ -terpineol, I, with 1 per cent. alkaline potassium permanganate hydroxylates the double bond to produce the trihydroxy compound II,  $C_{10}H_{20}O_3$ . This, on oxidation with chromic acid (chromium trioxide in acetic acid), produces a compound with the molecular formula  $C_{10}H_{16}O_3$  (IV). This compound was shown to contain a ketonic group, and that it was neutral, *e.g.*, it gave no reaction with sodium carbonate solution. When, however, IV was refluxed with excess of standard sodium hydroxide solution, and then back titrated, it was found that alkali had been consumed, the amount corresponding to the presence of one carboxyl group. Thus compound IV appears to be the *lactone* of a monocarboxylic acid. Furthermore, since it is the lactone that is isolated and not the hydroxy acid, this *spontaneous* lactonisation may be interpreted as being produced from a  $\gamma$ -hydroxyacid, *i.e.*, IV is a  $\gamma$ -lactone, and therefore III is a  $\gamma$ -hydroxyacid. It is possible, however, for  $\delta$ -hydroxyacids to spontaneously lactonise, and so whether IV is a  $\gamma$ - or  $\delta$ -lactone is uncertain at this stage of the evidence. Now, since IV is formed from II by scission of the glycol bond, and since

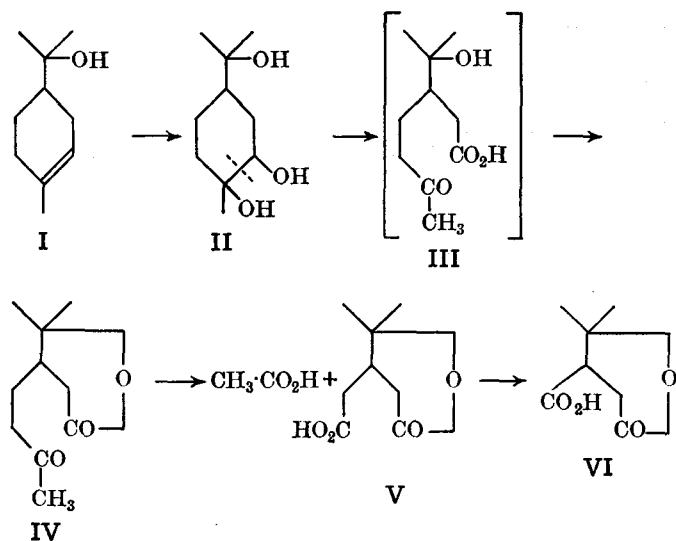

there is *no loss of carbon atoms* in the process, the double bond must therefore be in the ring in I. On warming with alkaline permanganate, IV gave acetic acid and a compound  $\text{C}_8\text{H}_{12}\text{O}_4$  (V). The formation of acetic acid suggests that IV is a *methyl ketone*, *i.e.*, a  $\text{CH}_3\cdot\text{CO}$  group is present. Thus IV is a methyl ketone and a lactone; it is known as homoterpenyl methyl ketone, and the structure assigned to it has been confirmed by synthesis (Simonsen *et al.*, 1932). A study of the properties of terpenylic acid, V, showed that it was the lactone of a monohydroxydicarboxylic acid. Further oxidation of terpenylic acid gives terebic acid  $\text{C}_7\text{H}_{10}\text{O}_4$  (VI), which is also the lactone of a monohydroxydicarboxylic acid.

The above reactions can be formulated as shown, *assuming* I (*p*-menth-1-en-8-ol) as the structure of α-terpineol. These reactions were formulated by Wallach, who adopted formula I which had been proposed by Wagner (1894). The structures of terpenylic (V) and terebic (VI) acids were established by synthesis, *e.g.*, those of Simonsen (1907).

**Terebic acid**, m.p. 175°.

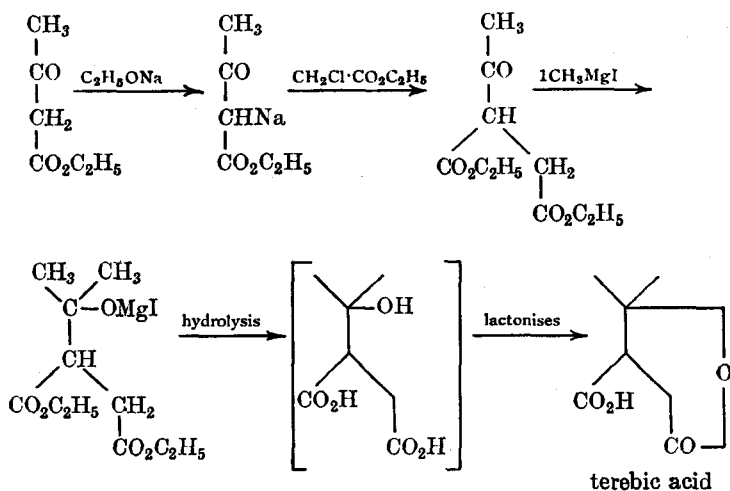

## Terpenylic acid, m.p. 90°.

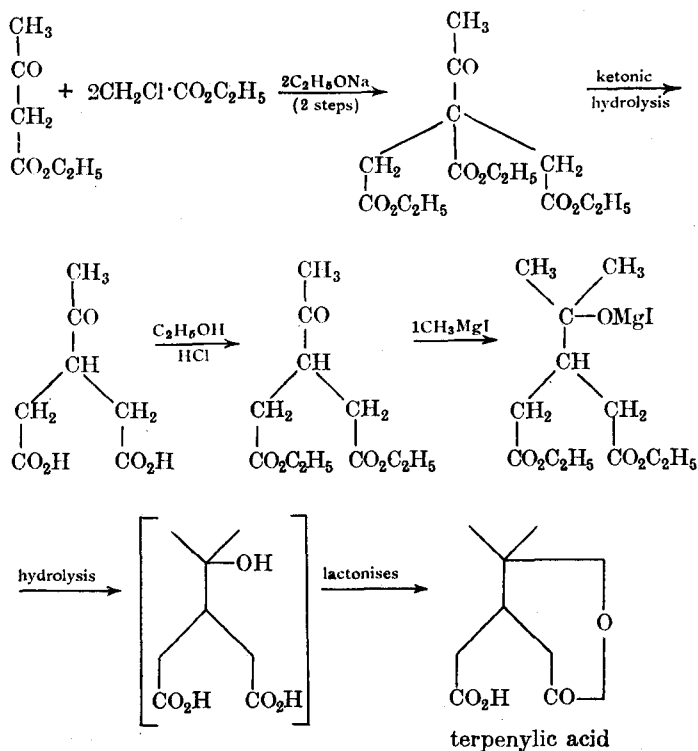

It is of interest to note here that Sandberg (1957) has prepared the  $\beta$ -acetotricarballylate in *one* step from acetoacetic ester and ethyl bromoacetate in the presence of sodium hydride (in benzene solution).

These syntheses strengthen the evidence for the structure assigned to  $\alpha$ -terpineol, but final proof rests with a synthesis of  $\alpha$ -terpineol itself. This has been carried out by Perkin, junior (1904), and by Perkin, junior, with Meldrum and Fisher (1908). Only the second synthesis is given here; this starts with *p*-toluic acid.

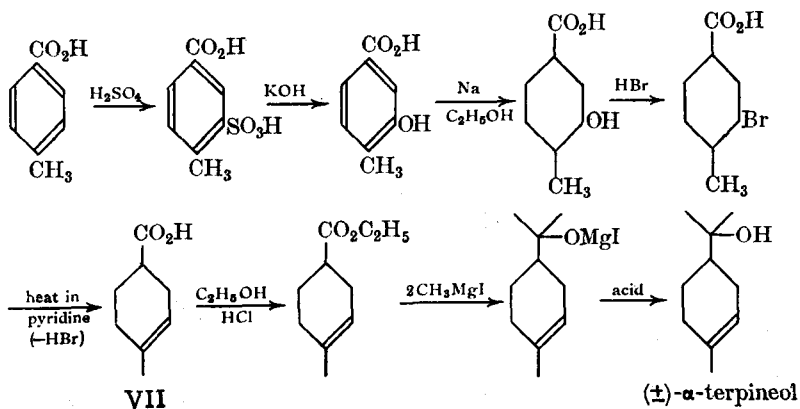

Compound VII was also resolved with strychnine, each enantiomorph treated as shown above (esterified, etc.), and thereby resulted in the formation of (+)- and (-)-terpineol. It should be noted that in the above synthesis

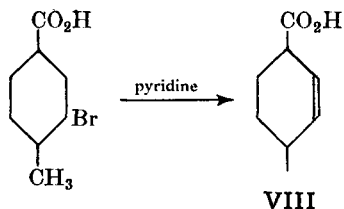

the removal of a molecule of hydrogen bromide from 3-bromo-4-methylcyclohexane-1-carboxylic acid to give VII is an ambiguous step; instead of VII, compound VIII could have been formed. That VII and not VIII is formed rests on the analytical evidence for the position of this double bond; VIII cannot give the products of oxidation that are actually obtained from  $\alpha$ -terpineol.

A much simpler synthesis of  $\alpha$ -terpineol has been carried out by Alder and Vogt (1949); this makes use of the Diels-Alder reaction, using isoprene and methyl vinyl ketone as the starting materials (see also Vol. I).

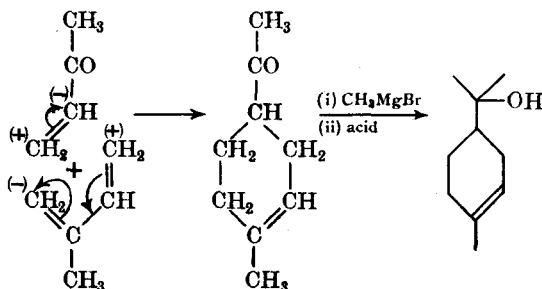

Two other terpineols are also known, *viz.*,  $\beta$ -terpineol and  $\gamma$ -terpineol; both occur naturally.

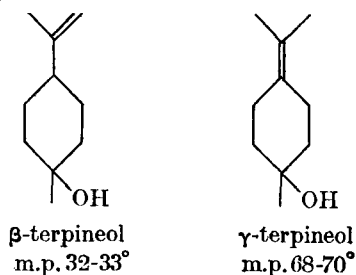

**§12. Carvone,  $C_{10}H_{14}O$ , b.p. 230°/755 mm.** This occurs in various essential oils, *e.g.*, spearmint and caraway oils, in optically active forms and also as the racemic modification.

Carvone behaves as a ketone and, since it adds on four bromine atoms, it therefore contains two double bonds. Thus the parent hydrocarbon is  $C_{10}H_{20}$ , and since this corresponds to the general formula  $C_nH_{2n}$ , carvone is monocyclic. When heated with phosphoric acid, carvone forms carvacrol; this suggests that carvone probably contains the *p*-cymene structure, and that the keto group is in the ring in the *ortho*-position with respect to the methyl group.

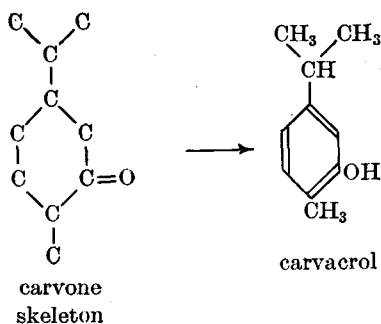

The structure of carvone is largely based on the fact that carvone may be prepared from  $\alpha$ -terpineol as follows:

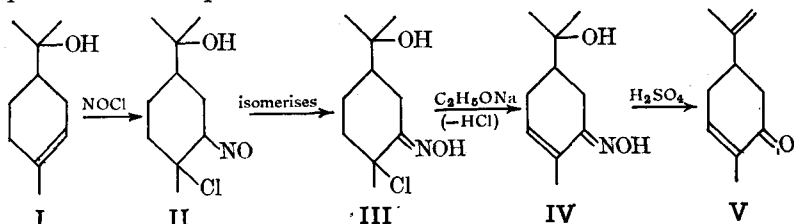

The addition of nitrosyl chloride to  $\alpha$ -terpineol, I, produces  $\alpha$ -terpineol nitrosochloride, II, the addition occurring according to Markownikoff's rule (the chlorine is the negative part of the addendum; see Vol. I). This nitrosochloride rearranges spontaneously to the oximino compound, III (see nitroso-compounds, Vol. I; it might be noted that this rearrangement proves the orientation of the addition of the nitrosyl chloride to the double bond; addition the other way could not give an oxime, since there is no hydrogen atom at position 1 in  $\alpha$ -terpineol). Removal of a molecule of hydrogen chloride from III by means of sodium ethoxide produces IV, and this, on warming with dilute sulphuric acid, loses a molecule of water with simultaneous hydrolysis of the oxime to form carvone, V. Thus, according to this interpretation of the reactions, carvone is *p*-menth-6 : 8-dien-2-one. Actually, these reactions show that carvone has the same carbon skeleton as  $\alpha$ -terpineol, and also confirm the position of the keto group. They do not prove conclusively the positions of the two double bonds; instead of position 6 (in IV), the double bond could have been 1(7), and instead of position 8 (as in V), the double bond could have been 4(8). Thus the above reactions constitute an ambiguous synthesis of carvone ( $\alpha$ -terpineol has already been synthesised). The exact positions of these two double bonds have been determined *analytically* as follows.

*The double bond in the 8-position.* The following reactions were carried out by Tiemann and Semmler (1895).

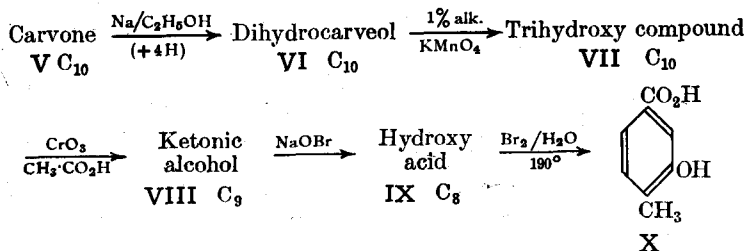

Reduction of carvone, V, with sodium and ethanol gives dihydrocarveol,  $C_{10}H_{18}O$  (VI); this is a secondary alcohol and contains *one* double bond, *i.e.*, the keto group and *one* of the two double bonds in carvone have been reduced. Hydroxylation of the double bond in dihydrocarveol by means of 1 per cent. alkaline permanganate produces the trihydroxy compound  $C_{10}H_{20}O_3$  (VII). Oxidation of VII with chromic acid causes scission of the glycol bond to produce a compound  $C_9H_{18}O_2$  (VIII); this was shown to contain a keto group and a hydroxyl (alcoholic) group. The action of sodium hypobromite on VIII caused the loss of one carbon atom to produce the compound  $C_8H_{14}O_3$  (IX); this was shown to be a hydroxymonocarboxylic acid, and since *one* carbon is lost in its formation, its precursor VIII must therefore be a methyl ketone. Finally, dehydrogenation of IX by heating with bromine-water at  $190^\circ$  under pressure produced *m*-hydroxy-*p*-toluic acid, X (a *known* compound). Tiemann and Semmler explained these reactions on the assumption that one double bond in carvone is in the 8-position. Thus:

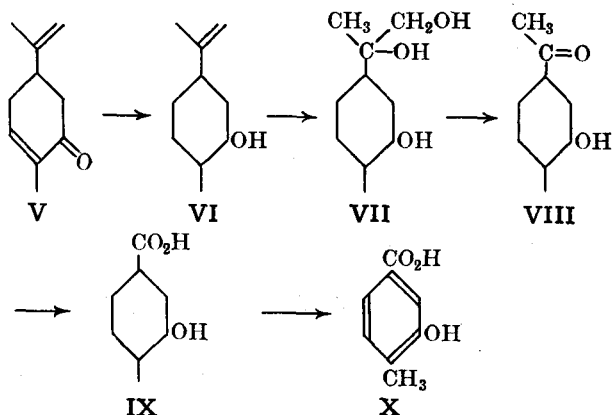

Had the double bond been in the 4(8)-position (structure Va), then compound VIII, and consequently X, could not have been obtained, since *three* carbon atoms would have been lost during the oxidation.

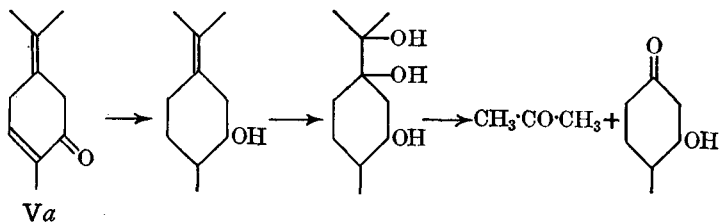

It might be noted in passing that V contains an asymmetric carbon atom, whereas Va is a symmetrical molecule and so cannot exhibit optical activity. Since carvone is known in optically active forms, structure Va must be rejected on these grounds.

*The double bond in the 6-position.* Carvone adds on one molecule of hydrogen bromide to form carvone hydrobromide,  $C_{10}H_{18}OBr$  (XI), and this, on treatment with zinc dust and methanol, is converted into carvotanacetone,  $C_{10}H_{18}O$  (XII), by replacement of the bromine atom by hydrogen. Thus the final result of these reactions is to saturate *one* of the two double bonds in carvone. Carvotanacetone, on oxidation with permanganate, gives isopropylsuccinic acid, XIII, and pyruvic acid, XIV (Semmler,

1900). These products are obtainable only if the ring contains the double bond in the 6-position. Had the double bond been in the 1(7)-position,

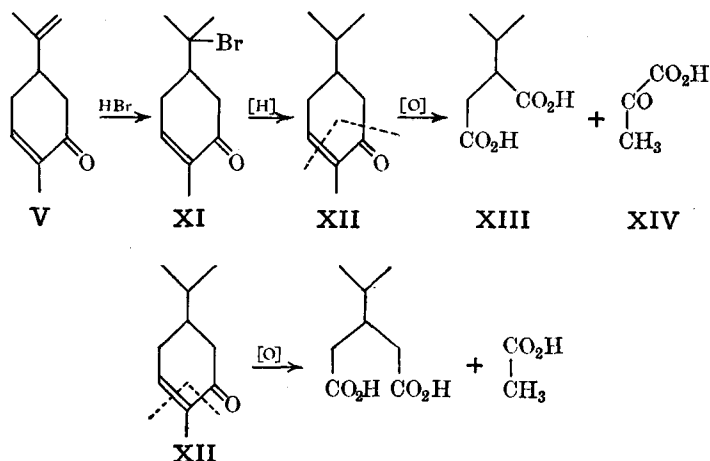

formic acid and not pyruvic acid would have been obtained. Further support for the 6-position is provided by the work of Simonsen *et al.* (1922), who obtained  $\beta$ -isopropylglutaric acid and acetic acid on oxidation of carvotanacetone with permanganate.

§13. **Limonene**,  $\text{C}_{10}\text{H}_{16}$ , b.p.  $175.5\text{--}176.5^\circ$ . This is optically active; the (+)-form occurs in lemon and orange oils, the (-)-form in peppermint oil, and the ( $\pm$ )-form in turpentine oil. The racemic modification is also produced by racemisation of the optically active forms at about  $250^\circ$ . The racemic modification is also known as **dipentene**; this name was given to the inactive form before its relation to the active form (limonene) was known.

Since limonene adds on four bromine atoms, it therefore contains two double bonds. (+)-Limonene may be prepared by dehydrating (+)- $\alpha$ -terpineol with potassium hydrogen sulphate, and limonene (or dipentene) may be converted into  $\alpha$ -terpineol on shaking with dilute sulphuric acid.

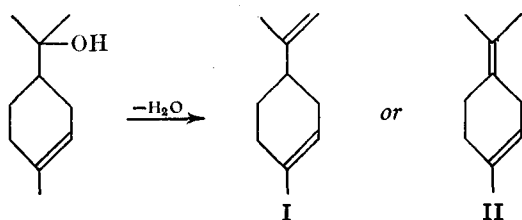

Thus the carbon skeleton and the position of one double bond in limonene are known. The position of the other double bond, however, remains uncertain from this preparation; I or II is possible.

*Proof for position 8.* Structure I contains an asymmetric carbon atom ( $\text{C}_4$ ), and hence can exhibit optical activity. II is a symmetrical molecule and so cannot be optically active. Therefore I must be limonene.

Chemical proof for position 8 is afforded by the following reactions:

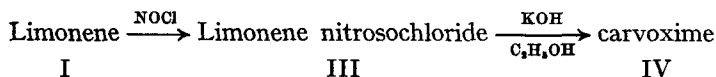



Since the structure of carboxime is known, it therefore follows that I must have one double bond in position 8; thus the above reactions may be written:

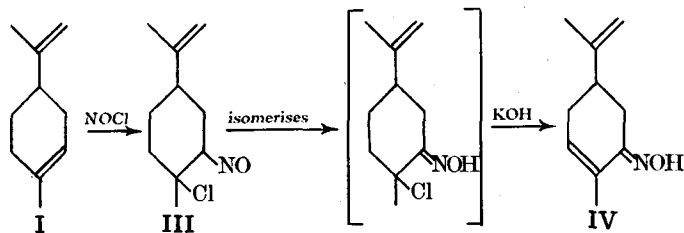

The connection between limonene and dipentene is shown by the fact that (+)- or (-)-limonene adds on two molecules of hydrogen chloride in the presence of moisture to form limonene dihydrochloride, and this is identical with dipentene dihydrochloride.

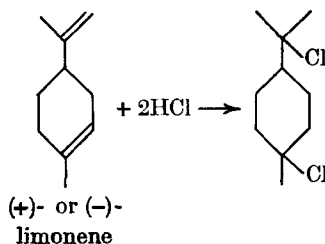

Limonene dihydrochloride no longer contains an asymmetric carbon atom, and so is optically inactive. It can, however, exhibit geometrical isomerism; the *cis*-form is produced from limonene, and the *trans*-form from cineole (§14).

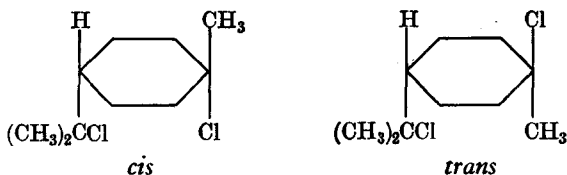

Dipentene can be regenerated by heating the dihydrochloride with sodium acetate in acetic acid, or boiling with aniline. On the other hand, when limonene dihydrochloride is heated with silver acetate in acetic acid, and then hydrolysing the ester with sodium hydroxide, 1:8-terpin is formed; the direct action of sodium hydroxide on the dihydrochloride regenerates dipentene.

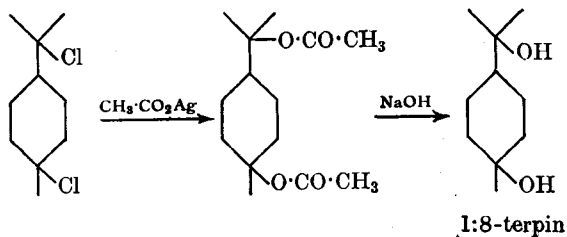

1 : 8-Terpin exists in two geometrical isomeric forms, corresponding to the *cis* and *trans* dipentene dihydrochlorides. *cis*-1 : 8-Terpin is the common form, m.p. 105°, and readily combines with one molecule of water to form terpin hydrate. The *trans*-form, m.p. 158–159°, does not form a hydrate (see also §14).

There is also a 1 : 4-terpin; this was originally prepared by the action of dilute alkali on terpinene dihydrochloride.

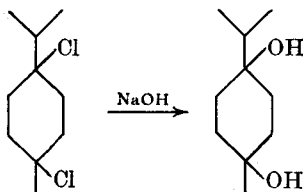

**Terpinenes,  $C_{10}H_{16}$ .** There are three isomeric terpinenes, and all give the same terpinene dihydrochloride with hydrogen chloride.

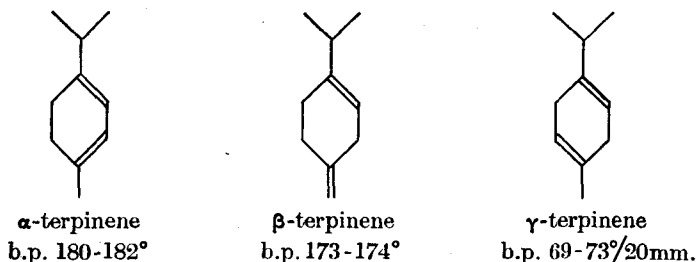

All three occur naturally.

**Terpinolene,  $C_{10}H_{16}$ ,** b.p. 67–68°/10 mm. This occurs naturally. It is not optically active, and since it may be prepared by dehydrating  $\alpha$ -terpineol with oxalic acid, its structure is known (it is II, the alternative formula offered for limonene). Terpinolene adds on two molecules of hydrogen chloride to form dipentene dihydrochloride.

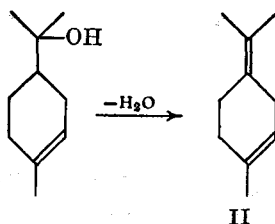

**Phellandrenes,  $C_{10}H_{16}$ .** There are two phellandrenes, both of which are optically active, and all the enantiomorphs occur naturally.

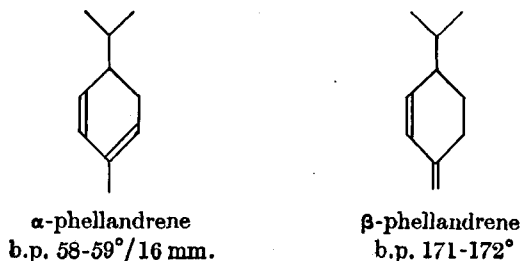

§14. **1 : 8-Cineole**,  $C_{10}H_{18}O$ , b.p.  $174.4^{\circ}$ . This occurs in eucalyptus oils. It is isomeric with  $\alpha$ -terpineol, but contains neither a hydroxyl group nor a double bond. The oxygen atom in cineole is inert, *e.g.*, it is not attacked by sodium or by the usual reducing agents. This inertness suggests that the oxygen atom is of the ether type. Support for this is obtained from the fact that dehydration of *cis*-1 : 8-terpin gives 1 : 8-cineole; at the same time, this reaction suggests that the structure of cineole is I.

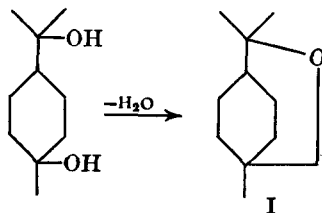

Further support for this structure is afforded by a study of the products obtained by oxidation (Wallach *et al.*, 1888, 1890, 1892). When oxidised with potassium permanganate, cineole forms cineolic acid, II, and this, on distillation with acetic anhydride, forms cineolic anhydride, III. When distilled at atmospheric pressure, cineolic anhydride forms 6-methylhept-5-en-2-one, IV, a *known* compound (§5). These reactions were interpreted by Wallach as follows:

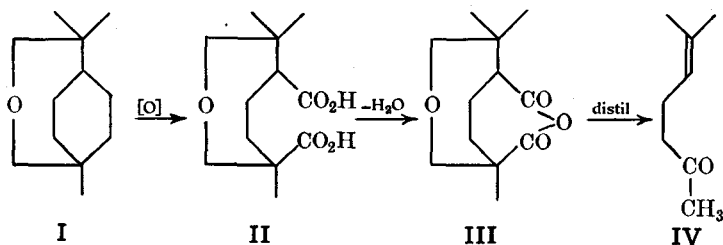

Further work on the structure of cineolic acid has confirmed the above sequence of reactions (Rupe, 1901, —).

It seems most probable that the 1 : 8-terpins have chair conformations, but when they form 1 : 8-cineole, the latter possesses the boat conformation; thus:

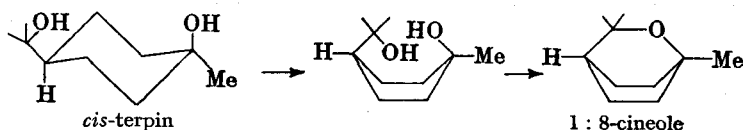

There is also a **1 : 4-cineole**; this occurs naturally.

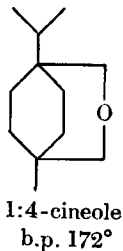

**Ascaridole**,  $C_{10}H_{16}O_2$ , b.p. 96–97°/8 mm. The cineoles are oxides; ascaridole, however, is a peroxide, the only known terpene peroxide, and it occurs naturally in, *e.g.*, chenopodium oil. When heated to 130–150°, ascaridole decomposes with explosive violence. When reduced catalytically, ascaridole forms 1 : 4-terpin (Wallach, 1912), and this led to the suggestion that

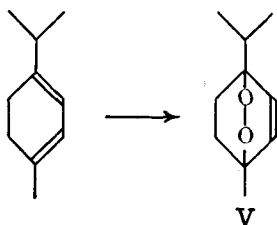

ascaridole is V. This structure has been confirmed by further analytical work. Ascaridole has been synthesised by Ziegler *et al.* (1944) by the irradiation of  $\alpha$ -terpinene in dilute solution in the presence of chlorophyll.

§15. **Sylvestrene**,  $C_{10}H_{16}$ , b.p. 175–178°. This compound exists in (+)-, (–)- and ( $\pm$ )-forms; the racemic modification is also known as **carvestrene** (*cf.* limonene and dipentene, §13). The (+)-form of sylvestrene was first obtained from Swedish pine needle oil (Attenberg, 1877), and was shown to contain the *m*-cymene carbon skeleton (Baeyer *et al.*, 1898). Thus sylvestrene appeared to be the only monocyclic monoterpene which did not have the *p*-cymene structure and was obtainable from natural sources. Although the *m*-cymene structure can be divided into two isoprene units (Wallach's isoprene rule), these two units are not joined head to tail.

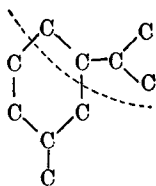

*m*-cymene skeleton

Subsequent work, however, showed that sylvestrene does not occur in pine oil. In the extraction of sylvestrene, the pine oil is heated with hydrogen chloride to give sylvestrene dihydrochloride. This compound was shown

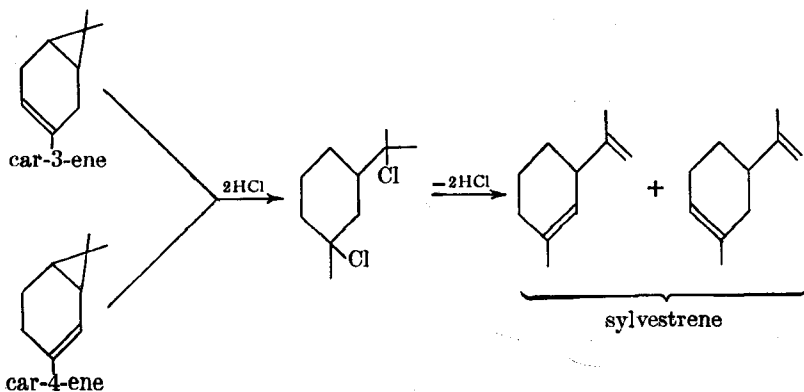

by Simonsen *et al.* (1923, 1925) to be produced by the action of hydrogen chloride on car-3-ene, *i.e.*, these workers showed conclusively that the terpene originally present in Swedish pine oil is car-3-ene. Sylvestrene may be obtained from its dihydrochloride by heating the latter with aniline; removal of hydrogen chloride from the ring can give rise to two possible positions for the ring double bond. Analytical work has shown that the side-chain is *isopropenyl* (and not *isopropylidene*), and that sylvestrene is a mixture of the two forms, *m*-mentha-1:8-diene and *m*-mentha-6:8-diene. Furthermore, it has been shown that car-4-ene is also present in pine oil; both of these carenes are readily converted into sylvestrene, and so it appears that the precursor of sylvestrene (itself a mixture) is a mixture of the two carenes (see §21).

The enantiomorphs of sylvestrene have been synthesised (Perkin, junior, *et al.*, 1913), and it has also been shown that an equimolecular mixture of the dihydrochlorides of (+)- and (–)-sylvestrene is identical with carvestrene dihydrochloride.

**§16. Menthol and menthone.** Menthol,  $C_{10}H_{20}O$ , is an optically active compound, but only the (–)-form occurs naturally, *e.g.*, in peppermint oils. (–)-Menthol, m.p.  $34^{\circ}$ , is a saturated compound, and the functional nature of the oxygen atom is alcoholic, as shown by its reactions, *e.g.*, menthol forms esters. Furthermore, since oxidation converts menthol into menthone, a *ketone*, the alcoholic group in menthol is therefore secondary. Also, since reduction with hydrogen iodide gives *p*-menthane, menthol most probably contains this carbon skeleton. Finally, since (+)-pulegone gives menthol on reduction, and since the structure of pulegone is known to be I (see §17), it therefore follows that menthol must be II. This structure,

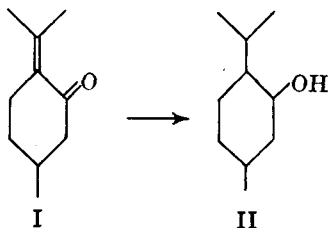

*p*-menth-3-ol, for menthol has been confirmed by consideration of the oxidation products of menthone (see below), and also by the synthesis of menthol.

Examination of the menthol structure shows that three dissimilar asymmetric carbon atoms (1, 3 and 4) are present; thus eight optically active forms (four racemic modifications) are possible theoretically. All eight enantiomorphs are known and their configurations are as follows (the horizontal lines represent the plane of the *cyclohexane* ring):

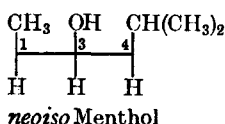
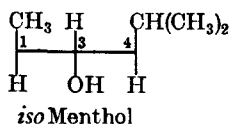
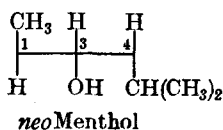
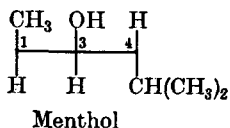

These configurations have been assigned from a study of chemical and optical relationships and the Auwers-Skita rule. More recently the application of conformational analysis has confirmed these results. Eliel (1953) applied the principle that the esterification of an axial hydroxyl group occurs less readily than with an equatorial one. Furthermore, Eliel postulated that the reaction proceeds *via* the conformation of the molecule in which the reactive hydroxyl group is equatorial, and that the rate differences should be attributed to that energy necessary to place the other substituents, if necessary, into the axial conformation (see also §12. IV). On this basis, the rates of esterification of the isomeric menthols will be:

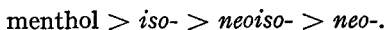

These are the orders of rates actually obtained by Read *et al.* (1934). The following conformations have been assigned by Eliel from chemical studies, and are supported by Cole *et al.* (1956) from their infra-red spectra and conformation studies.

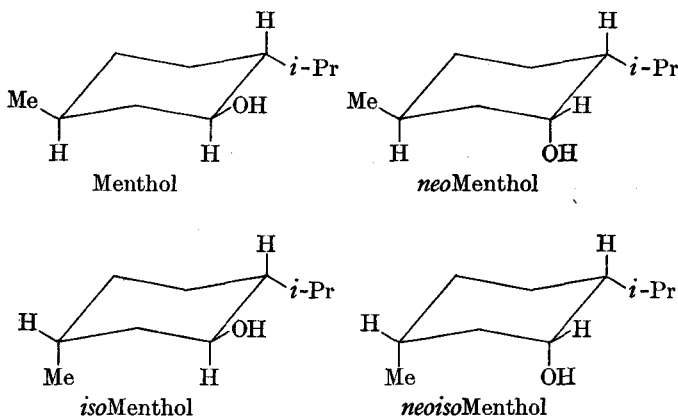

In menthol, *all* of the substituents are equatorial, and in the rest one is axial. It should also be noted that the larger of the two alkyl groups (*iso*-propyl) is always equatorial (*cf.* §11. IV).

**Menthone**,  $C_{10}H_{18}O$ , b.p.  $204^{\circ}/750$  mm. (–)-Menthone occurs in peppermint oil, and it may readily be prepared by the oxidation of (–)-menthol with chromic acid. Menthone is a saturated compound which has the characteristic properties of a ketone. When heated with hydriodic acid and red phosphorus, menthone is reduced to *p*-menthane; thus this skeleton is present in menthone. Oxidation of menthone with potassium permanganate produces a compound  $C_{10}H_{18}O_3$ ; this compound was shown to contain a keto-group and one carboxyl group, and is known as ketomenthylic acid (IV). Ketomenthylic acid itself is very readily oxidised by permanganate to  $\beta$ -methyladipic acid (V) and some other acids (Arth, 1886; Manasse *et al.*, 1894). The foregoing oxidative reactions may be formulated as follows, on the *assumption* that III is the structure of menthone. This

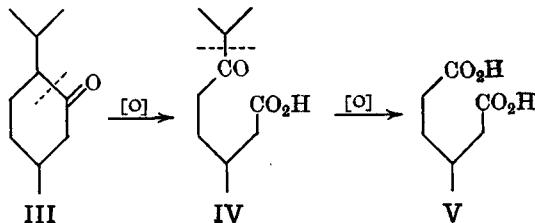

structure for menthone has been confirmed by synthesis, *e.g.*, Kötze and Schwarz (1907) obtained menthone by the distillation of the calcium salt of  $\beta'$ -methyl- $\alpha$ -isopropylpimelic acid, which was prepared as follows. 3-Methylcyclohexanone, VI, was condensed with ethyl oxalate in the presence of sodium, and the product VII then heated under reduced pressure; this gave the ethyl ester of 4-methylcyclohexan-2-one-1-carboxylic acid, VIII. VIII, on treatment with sodium ethoxide followed by isopropyl iodide, gave IX, and this when boiled with ethanolic sodium ethoxide and the product then acidified, gave  $\beta'$ -methyl- $\alpha$ -isopropylpimelic acid, X (note the acetoacetic ester fragment in VIII).

Structure III contains two dissimilar asymmetric carbon atoms (1 and 4), and so four optically active forms (and two racemic modifications) are possible. All are known, and correspond to the menthones and isomenthones; these are geometrical isomers, each one existing as a pair of enantiomorphs. The configurations have been assigned on physical evidence; the *cis*-isomer has the higher refractive index and density (Auwers-Skita rule; see §5 x. IV).

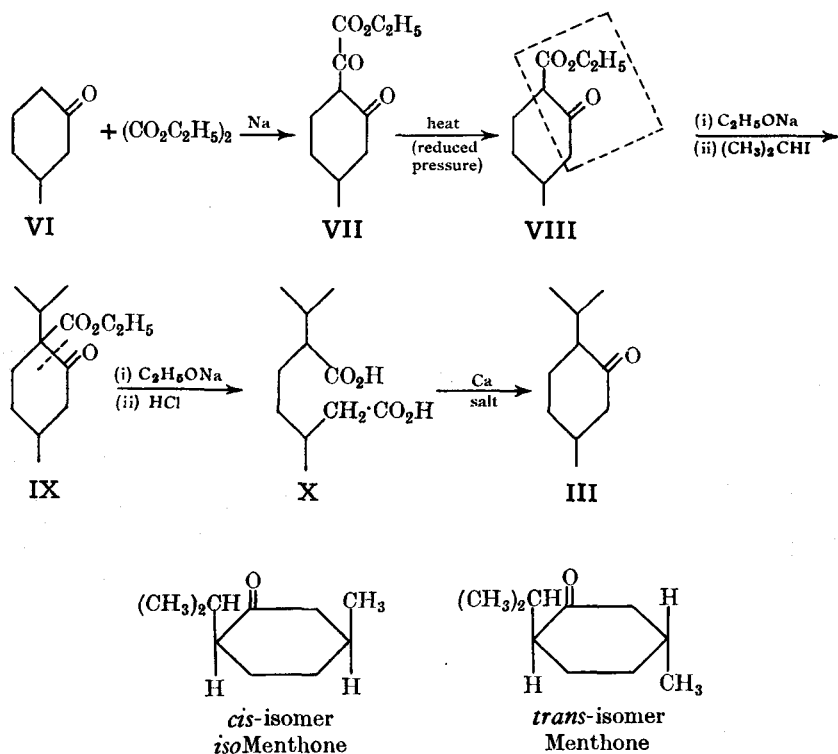

§17. ( $\pm$ )-Pulegone, C<sub>10</sub>H<sub>16</sub>O, b.p. 221–222°. This occurs in pennyroyal oils. Pulegone contains one double bond, and behaves as a ketone. On reduction, pulegone first gives menthone and this, on further reduction, gives menthol. When oxidised with permanganate, pulegone forms acetone and  $\beta$ -methyladipic acid (Semmler, 1892); when boiled with aqueous ethanolic potassium hydroxide, acetone and 3-methylcyclohexanone are obtained (Wallach, 1896). These reactions show that pulegone is *p*-menth-4(8)-en-3-one.

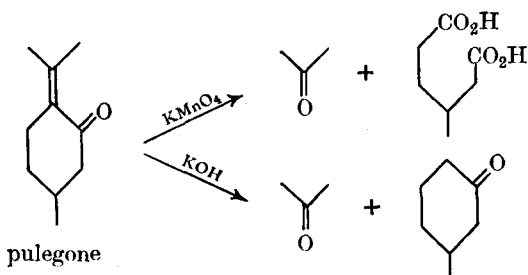

This structure has been confirmed by synthesis, starting from 3-methylcyclohexanone (Black *et al.*, 1956: *cf.* menthone, §16).

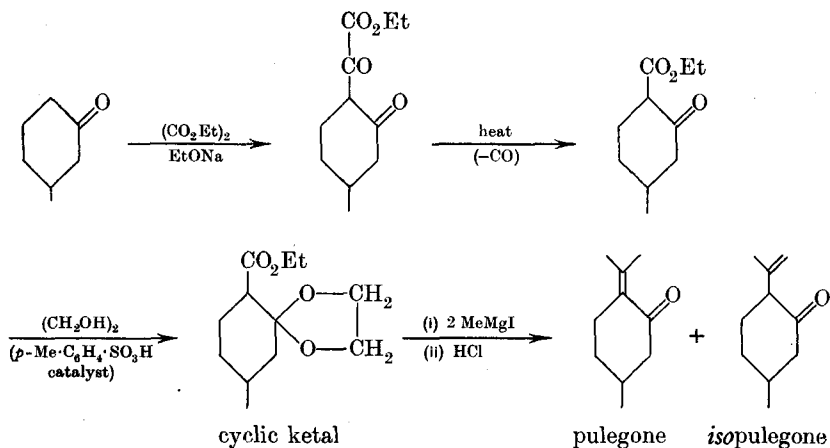

*iso*Pulegone can be isomerised to pulegone by alkaline reagents (Kon *et al.*, 1927), and Black *et al.* found that, on treating their mixture with sodium ethoxide, the resulting compound was pure pulegone.

§18. (–)-Piperitone,  $C_{10}H_{16}O$ , b.p. 232–233°/768 mm. This occurs in eucalyptus oils, and is a valuable source of menthone and thymol. Piperitone contains one double bond, and behaves as a ketone. Piperitone, on catalytic hydrogenation (nickel), gives menthone in almost quantitative yield; on oxidation with ferric chloride, thymol is obtained (Smith *et al.*, 1920). These reactions show that piperitone is *p*-menthene-3-one, but do

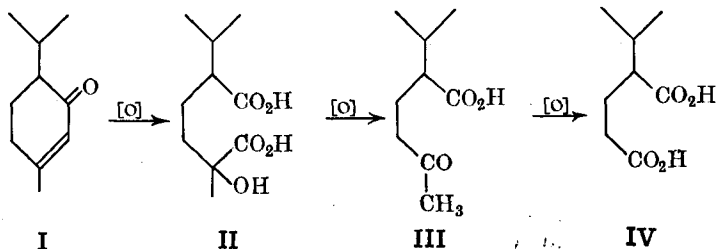

not show the position of the double bond. This had been shown by Schimmel (1910), who found that on oxidation with alkaline permanganate, piperitone gave  $\alpha$ -hydroxy- $\alpha$ -methyl- $\alpha'$ -isopropylgladipic acid, II,  $\gamma$ -acetyl- $\alpha$ -isopropylbutyric acid, III, and  $\alpha$ -isopropylglutaric acid, IV. These results can be explained only if piperitone is *p*-menth-1-en-3-one, I. This structure for piperitone has been confirmed by various syntheses (*e.g.*, Henecka,



1948; Birch *et al.*, 1949). Bergmann *et al.* (1959) have shown that piperitone is formed directly by the condensation of mesityl oxide with methyl vinyl ketone.

### BICYCLIC MONOTERPENES

§19. Introduction. The bicyclic monoterpenes may be divided into three classes according to the size of the *second* ring, the first being a six-membered ring in each class.

**Class I** (6- + 3-membered ring).

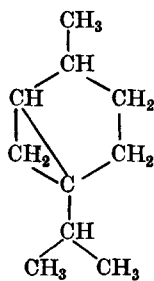

thujane

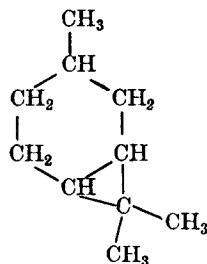

carane

**Class II** (6- + 4-membered ring).

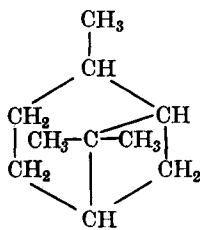

pinane

**Class III** (6- + 5-membered ring).

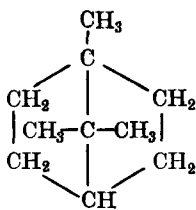

camphane

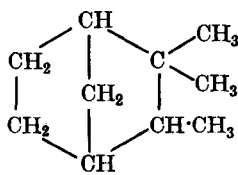

isocamphane

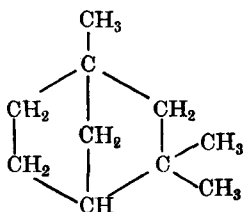

fenchane

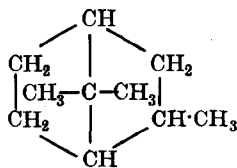

isobornylene

It is important to note that the two rings do not lie in one plane, but are almost perpendicular to each other (see, *e.g.*, §23b).

§20. **Thujone and its derivatives.** The members of this group which occur naturally are the following:

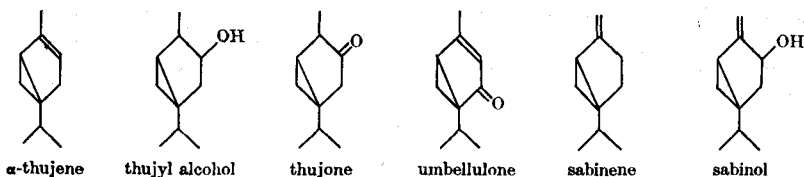

§21. **Carane and its derivatives.** It appears that only three carane derivatives occur naturally:

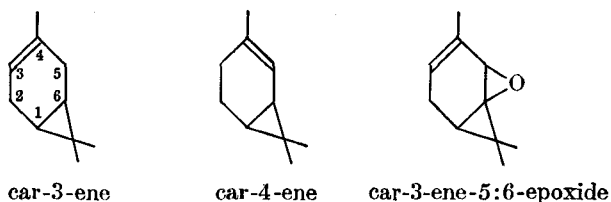

**Car-3-ene** occurs in Swedish pine needle oil. It is a liquid, b.p. 170°; when treated with hydrogen chloride it forms a mixture of sylvestrene dihydrochloride (see §15) and dipentene dihydrochloride (§13).

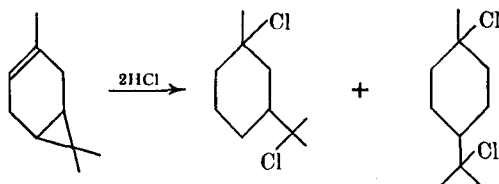

(+)-**Car-4-ene**, b.p. 165.5–167°/707 mm., occurs in various essential oils. It forms sylvestrene dihydrochloride on treatment with hydrogen chloride (§15).

**Car-3-ene-5 : 6-epoxide**, b.p. 83–85°/14 mm., occurs in certain essential oils.

**Carone**, b.p. 99–100°/15 mm., is a synthetic compound, and is of some importance because of its relationship to carane. It was first prepared by

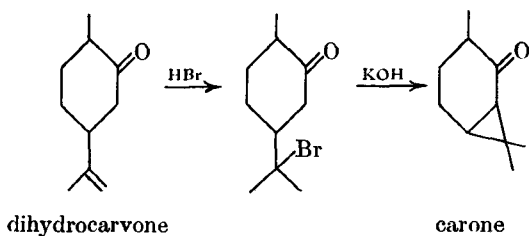

Baeyer *et al.* (1894) by the action of hydrogen bromide on dihydrocarvone, which was then treated with ethanolic potassium hydroxide, whereupon carone was obtained.

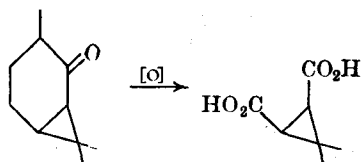

The structure of carone was established by Baeyer *et al.* (1896), who obtained caronic acid on oxidation of carone with permanganate. Baeyer suggested that caronic acid was a *cyclopropane* derivative, and this was confirmed by synthesis (Perkin, junior, and Thorpe, 1899), starting with ethyl  $\beta$ : $\beta$ -dimethylacrylate and ethyl cyanoacetate.

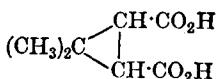
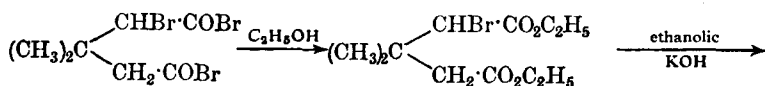
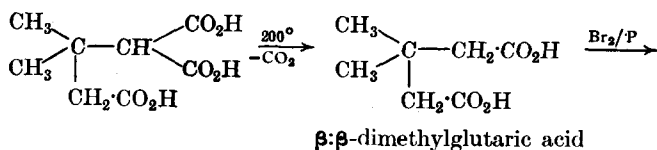
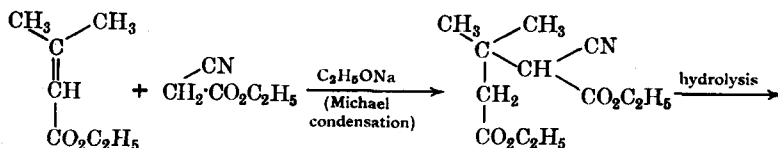

An interesting point about carone is that its ultraviolet absorption spectrum shows similarities to that of  $\alpha$ : $\beta$ -unsaturated ketones (Klotz, 1941).

§22. **Pinane and its derivatives.** Pinane, the parent compound of this group, is a synthetic substance which may be prepared by the catalytic hydrogenation (nickel or platinum) of either  $\alpha$ - or  $\beta$ -pinene. Pinane exists

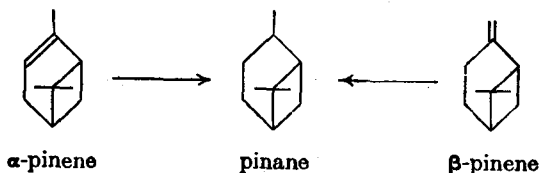

in two geometrical isomeric forms, *cis* and *trans*, and each of these exists as a pair of enantiomorphs.

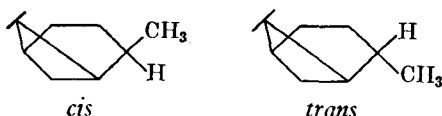

§22a.  $\alpha$ -Pinene. This is the most important member of the pinane class. It occurs in both the (+)- and (-)-forms in all turpentine oils; it is a liquid, b.p.  $156^\circ$ .

The analytical evidence for the structure of  $\alpha$ -pinene may conveniently be divided into two sections, each section leading independently to the structure, and the two taken together giving very powerful evidence for the structure assigned.

*Method I.* The molecular formula of  $\alpha$ -pinene is  $C_{10}H_{16}$ , and since  $\alpha$ -pinene adds on two bromine atoms, one double bond is present in the molecule. Thus the parent hydrocarbon is  $C_{10}H_{18}$ , and since this corresponds to the general formula  $C_nH_{2n-2}$  the general formula of compounds containing two rings, it therefore follows that  $\alpha$ -pinene is bicyclic (Wallach, 1887-1891). In the preparation of  $\alpha$ -pinene nitrosochloride (by the action of nitrosyl chloride on  $\alpha$ -pinene) the by-products which were formed were steam distilled, and the compound *pinol*,  $C_{10}H_{16}O$ , was thereby obtained. Pinol adds on one molecule of bromine to form pinol dibromide, and so pinol contains one double bond. Furthermore, the action of lead hydroxide on pinol dibromide converts the latter into pinol glycol,  $C_{10}H_{16}O(OH)_2$ , and this, on oxidation, gives terpenylic acid (Wallach *et al.*, 1889). Pinol (III) is also obtained by the action of sodium ethoxide on  $\alpha$ -terpineol dibromide, II (Wallach, 1893). Wagner (1894) showed that the oxidation of pinol with permanganate gives pinol glycol (IV), which is further oxidised to terpenylic acid (V). All these facts can be explained as follows, based on I being the structure of  $\alpha$ -terpineol (see also §11).

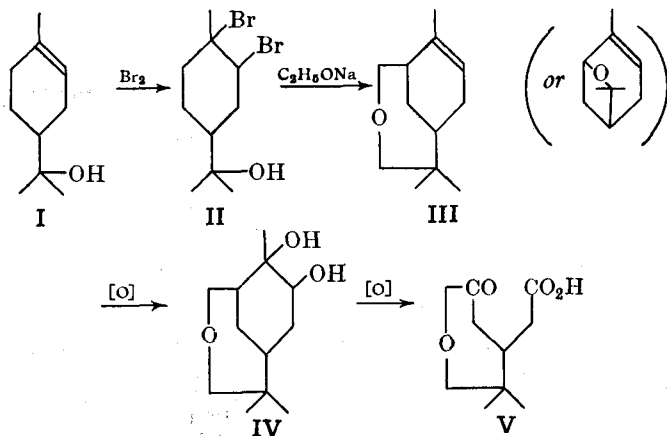

Support for the structure given for pinol (III) is obtained from the fact that oxidation of *sobrerol* (pinol hydrate) produces a tetrahydric alcohol, *sobrerithritol*. Sobrerol itself is readily prepared by the action of hydrogen bromide on pinol, followed by sodium hydroxide. These reactions may thus be formulated:

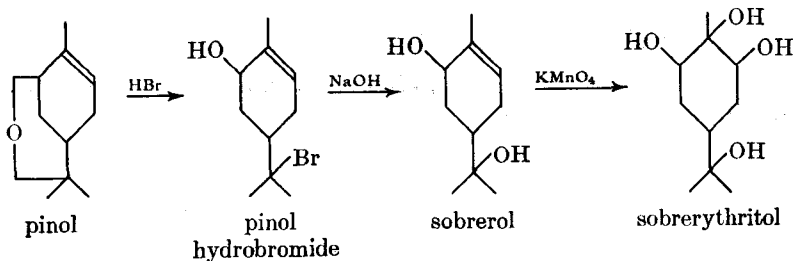

Thus, if the formula for  $\alpha$ -pinene is VI, then the formation of the above substances can be explained. This structure also accounts for other reactions of  $\alpha$ -pinene, *e.g.*, its ready hydration to  $\alpha$ -terpineol (see later).



VI

Although the Wagner formula (VI) for  $\alpha$ -pinene readily explains all the facts, there is no *direct* evidence for the existence of the *cyclobutane* ring. Such evidence was supplied by Baeyer (1896). This is described in method 2.

*Method 2.* As in *method 1*,  $\alpha$ -pinene was shown to be bicyclic. When treated with ethanolic sulphuric acid,  $\alpha$ -pinene is converted into  $\alpha$ -terpineol (Flavitzky, 1879). Therefore  $\alpha$ -pinene contains a six-membered ring and another ring (since it is bicyclic), the carbon skeleton of pinene being such as to give  $\alpha$ -terpineol when this second ring opens. Since, in the formation of  $\alpha$ -terpineol, one molecule of water is taken up and the hydroxyl group becomes attached to  $C_8$ , this suggests that the  $C_8$  of  $\alpha$ -terpineol is involved in forming the second ring in  $\alpha$ -pinene. There are three possible points of union for this  $C_8$ , resulting in two three-membered and one four-membered ring (see VII); at the same time the position of the double bond in  $\alpha$ -pinene is also shown by the conversion into  $\alpha$ -terpineol (I).

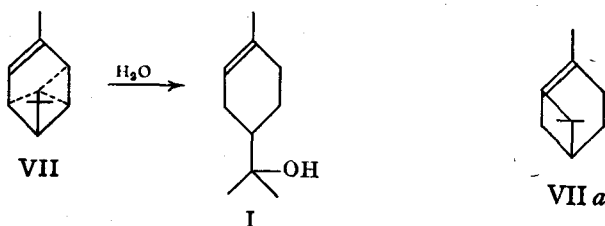

A point of interest here is that there are actually *four* possible points of union for  $C_8$ , the three shown in VII and the fourth being at the double bond to form a four-membered ring (VIIa). This one, however, was rejected on the grounds of *Bredt's rule* (1924) which states that a double bond cannot be formed by a carbon atom occupying the bridge-head (of a bicyclic system). The explanation for this rule is that structures such as VIIa have a large amount of strain.

This second ring was shown to be four-membered by Baeyer (1896), who carried out the following series of reactions.

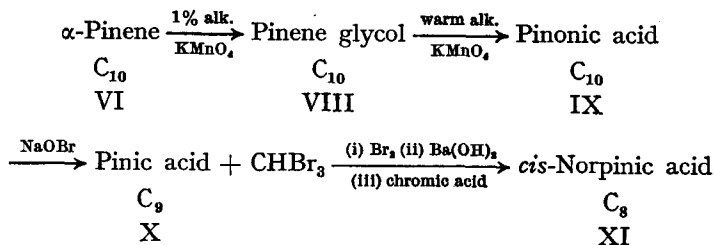

Pinene glycol,  $\text{C}_{10}\text{H}_{16}(\text{OH})_2$ , is produced by hydroxylation of the double bond in  $\alpha$ -pinene, and pinonic acid,  $\text{C}_{10}\text{H}_{16}\text{O}_3$ , is produced by scission of the glycol bond. Pinonic acid was shown to be a saturated keto-monocarboxylic

acid. The formation of pinic acid,  $C_9H_{14}O_4$ , and bromoform, indicates the presence of an acetyl group in pinonic acid. Pinic acid, which was shown to be a saturated dicarboxylic acid, on treatment with bromine, then barium hydroxide, and finally the product oxidised with chromic acid, gives *cis*-norpinic acid,  $C_8H_{12}O_4$ . This was shown to be a saturated dicarboxylic acid, and so its formula may be written  $C_6H_{10}(CO_2H)_2$ . Furthermore, since  $\alpha$ -pinene contains two methyl groups attached to a carbon atom in the second ring (see VII), and it is the *other* ring (the six-membered one containing the double bond) that has been opened by the above oxidation, then norpinic acid (with this second ring intact) contains these two methyl groups. Thus the formula for norpinic acid may be written  $(CH_3)_2C_4H_4(CO_2H)_2$ . Hence, regarding the methyl and carboxyl groups as substituents, the parent (saturated) hydrocarbon (from which norpinic acid is derived) is  $C_4H_8$ . This corresponds to *cyclobutane*, and so norpinic acid is (probably) a dimethyl-*cyclobutanedicarboxylic acid*. On this basis, pinic acid could therefore be a *cyclobutane* derivative with one side-chain of  $-CH_2CO_2H$ .

Baeyer therefore *assumed* that pinic and norpinic acids contained a *cyclobutane* ring, and so suggested the following structures to account for the above reactions, accepting structure VI for  $\alpha$ -pinene, the structure already proposed by Wagner (1894).

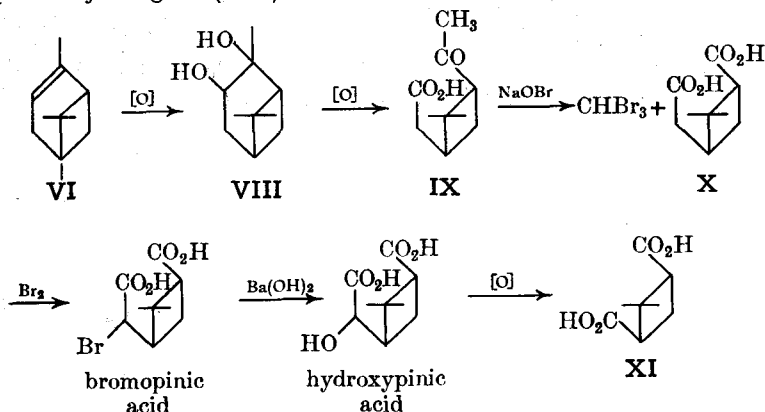

The synthesis of norpinic acid (to confirm the above reactions) proved to be a very difficult problem, and it was not carried out until 1929, when Kerr succeeded with the following ingenious method (apparently the presence of the *gem* dimethyl group prevents closure to form the *cyclobutane* ring).

The norpinic acid obtained was the *trans*-isomer; this is readily converted into the *cis*-isomer (the isomer obtained from the oxidation of  $\alpha$ -pinene) by heating the *trans* acid with acetic anhydride, whereupon the *cis* anhydride is formed and this, on hydrolysis, gives the *cis* acid (Simonsen *et al.*, 1929).

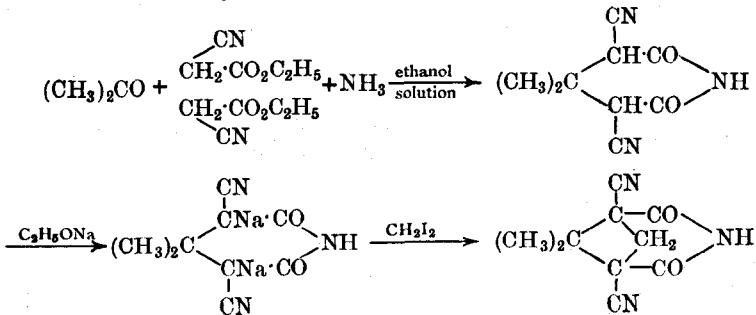

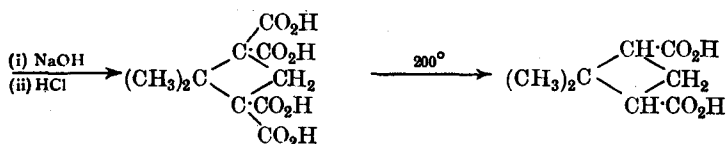

The total synthesis of  $\alpha$ -pinene has now been carried out in the following way. Guha *et al.* (1937) synthesised pinic acid from norpinic acid, and Rao (1943) synthesised pinonic acid from synthetic pinic acid.

Ruzicka *et al.* (1920–1924) had already synthesised  $\alpha$ -pinene starting from pinonic acid (obtained by the oxidation of  $\alpha$ -pinene). Thus we now have

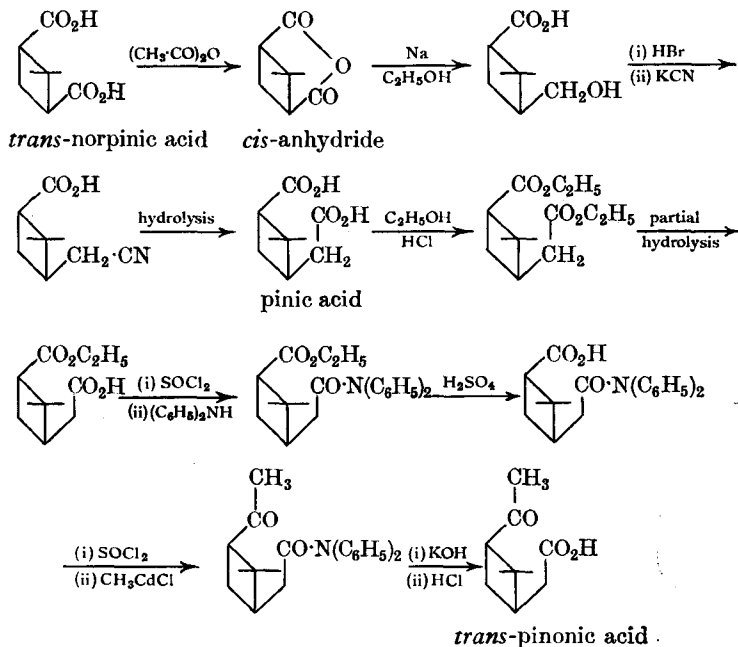

a total synthesis of  $\alpha$ -pinene. Ruzicka's synthesis makes use of the Darzens glycidic ester synthesis (see Vol. I); the steps are:

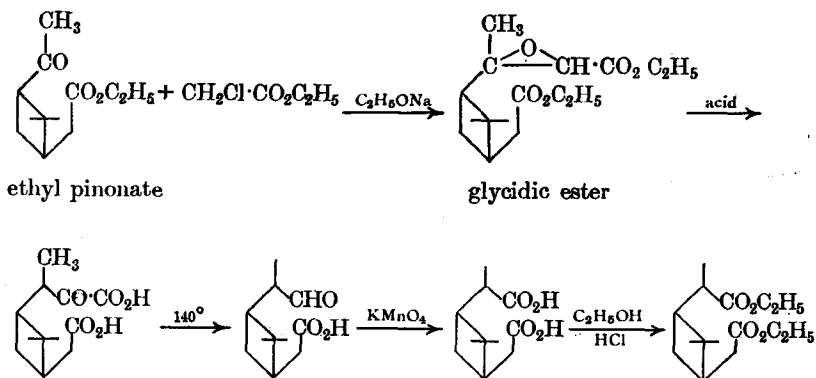

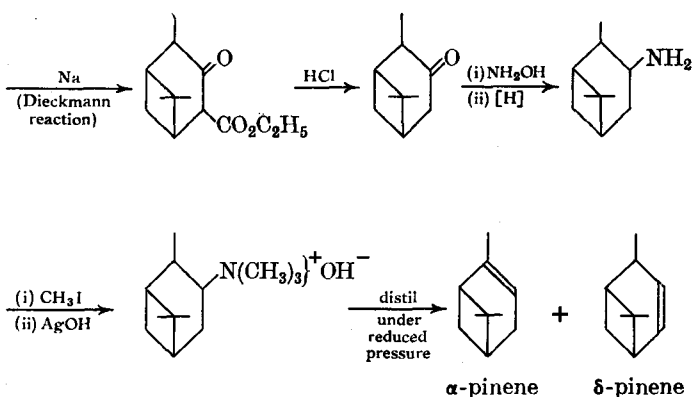

The final step gives a mixture of two compounds,  $\alpha$ - and  $\delta$ -pinene. The former was identified by the preparation of the nitroschloride; this proves that one of the products is  $\alpha$ -pinene, but does not prove which is  $\alpha$  and which is  $\delta$ . These are differentiated by consideration of the analytical evidence; the following evidence also supports the structure given for  $\alpha$ -pinene. This evidence is based on the fact that diazoacetic ester combines with compounds containing a double bond to form pyrazoline derivatives, and these, on heating alone or with copper powder, decompose to produce cyclopropane derivatives (see also §2a. XII). When the two pinenes were subjected to this

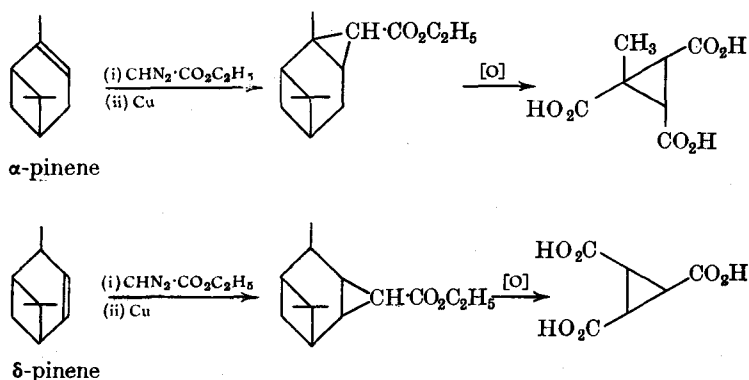

treatment, and the resulting compounds oxidised,  $\alpha$ -pinene gave 1-methylcyclopropane-1 : 2 : 3-tricarboxylic acid, and  $\delta$ -pinene cyclopropane-1 : 2 : 3-tricarboxylic acid. These products are in accord with the structures assigned to  $\alpha$ - and  $\delta$ -pinene.

Examination of the  $\alpha$ -pinene structure shows that two dissimilar asymmetric carbon atoms are present; thus two pairs of enantiomorphs are possible. In practice, however, only one pair is known. This is due to the fact that the four-membered ring can only be fused to the six-membered one in the *cis*-position; *trans* fusion is impossible. Thus only the enantiomorphs of the *cis*-isomer are known.

Isomeric with  $\alpha$ -pinene are  $\beta$ - and  $\delta$ -pinene; the former occurs naturally, the latter is synthetic (see Ruzicka's synthesis). Crowley (1962) has obtained a small amount of  $\beta$ -pinene by irradiating a one per cent. ethereal solution of myrcene (§4) with ultraviolet light. This is of some interest in connection with the biosynthesis of terpenes (see §32a).



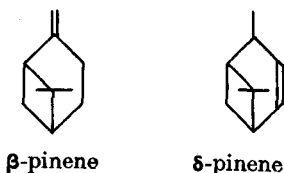

§23. **Camphane and its derivatives.** Camphane,  $C_{10}H_{18}$ , is a synthetic compound, and may be prepared from camphor, *e.g.*,

(i) By reduction of camphor to a mixture of borneols (§23b), these then converted to the bornyl iodides which are finally reduced to camphane (Aschan, 1900).

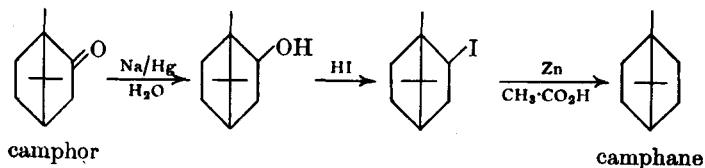

(ii) Camphor may also be converted to camphane by means of the Wolff-Kishner reduction (see also Vol. I).

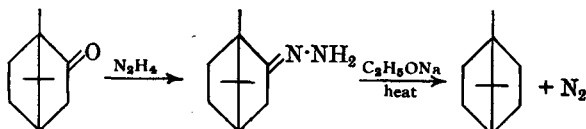

Camphane is a solid, m.p.  $156^\circ$ ; it is optically inactive.

§23a. **Camphor.** This occurs in nature in the camphor tree of Formosa and Japan. It is a solid, m.p.  $179^\circ$ , and is optically active; the (+)- and (-)-forms occur naturally, and so does racemic camphor, which is the usual form of synthetic camphor (from  $\alpha$ -pinene; see later).

A tremendous amount of work was done before the structure of camphor was successfully elucidated; in the following account only a small part of the work is described, but it is sufficient to justify the structure assigned to camphor.

The molecular formula of camphor is  $C_{10}H_{16}O$ , and the general reactions and molecular refractivity of camphor show that it is saturated. The functional nature of the oxygen atom was shown to be oxo by the fact that camphor formed an oxime, etc., and that it was a keto group was deduced from the fact that oxidation of camphor gives a *dicarboxylic acid* containing 10 carbon atoms; a *monocarboxylic acid* containing 10 carbon atoms cannot be obtained (this type of acid would be expected if camphor contained an *aldehyde group*). From the foregoing facts it can be seen that the parent hydrocarbon of camphor has the molecular formula  $C_{10}H_{18}$ ; this corresponds to  $C_nH_{2n-2}$ , and so camphor is therefore bicyclic. Camphor contains a  $-CH_2\cdot CO-$  group, since it forms an oxime with nitrous acid (*isoamyl nitrite* and hydrogen chloride). Finally, distillation of camphor with zinc chloride or phosphorus pentoxide produces *p*-cymene.

Bredt (1893) was the first to assign the correct formula to camphor (over 30 have been proposed). Bredt based his formula on the above facts and also on the facts that (a) oxidation of camphor with nitric acid gives **camphoric acid**,  $C_{10}H_{16}O_4$  (Malaguti, 1837); (b) oxidation of camphoric acid

(or camphor) with nitric acid gives **camphoric acid**,  $C_9H_{14}O_6$  (Bredt, 1893).

Since camphoric acid contains the same number of carbon atoms as camphor, the keto group must be in one of the rings in camphor. Camphoric acid is a dicarboxylic acid, and its molecular refractivity showed that it is saturated. Thus, in the formation of camphoric acid from camphor, the ring containing the keto group is opened, and consequently camphoric acid must be a monocyclic compound.

Camphoric acid was shown to be a saturated tricarboxylic acid, and on distillation at atmospheric pressure, it gave *isobutyric acid*, II, trimethylsuccinic acid, III, carbon dioxide and carbon (and a small amount of some other products). Bredt (1893) therefore *suggested* that camphoric acid is  $\alpha : \alpha - \beta$ -trimethyltricarballic acid, I, since this structure would give the required decomposition products. In the following equations, the left-hand-side molecule is imagined to break up as shown; one molecule of carbon dioxide and two molecules of *isobutyric acid* are produced (but there is a shortage of two hydrogen atoms). The right-hand-side molecule breaks up to form one molecule of trimethylsuccinic acid, one molecule of carbon dioxide, one atom of carbon and *two atoms of hydrogen* which now make up the shortage of the left-hand-side molecule. Thus:

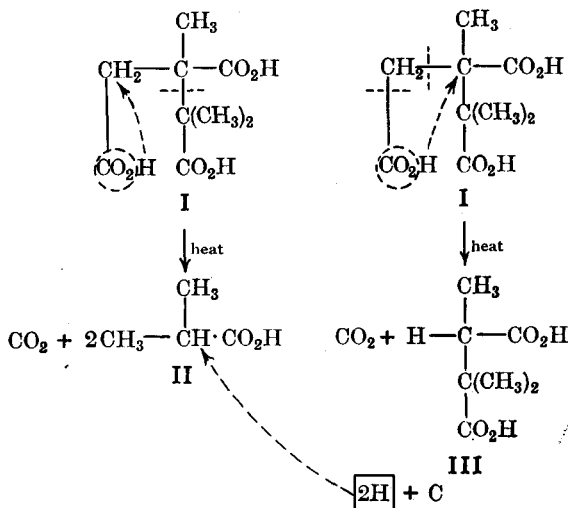

Hence, if camphoric acid has structure I, then camphoric acid (and camphor) must contain *three methyl groups*. On this basis, the formula of camphoric acid,  $C_{10}H_{16}O_4$ , can be written as  $(\text{CH}_3)_3\text{C}_5\text{H}_5(\text{CO}_2\text{H})_2$ . The parent (saturated) hydrocarbon of this is  $C_5H_{10}$ , which corresponds to  $C_nH_{2n}$ , *i.e.*, camphoric acid is a *cyclopentane derivative* (this agrees with the previous evidence that camphoric acid is monocyclic). Thus the oxidation of camphoric acid to camphoronic acid may be written:

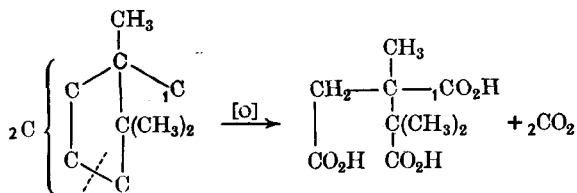

This skeleton, plus one carbon atom, arranged with two carboxyl groups, will therefore be the structure of camphoric acid. Now camphoric anhydride forms only one monobromo derivative (bromine and phosphorus); therefore there is only *one*  $\alpha$ -hydrogen atom in camphoric acid. Thus the carbon atom of one carboxyl group must be  $_1\text{C}$  (this is the only carbon atom joined to a tertiary carbon atom). Furthermore,  $_1\text{C}$  must be the carbon of the keto or methylene group in camphor, since it is these two groups which produce the two carboxyl groups in camphoric acid. The problem is now to find the position of the other carboxyl group in camphoric acid. Its position must be such that when the *cyclopentane* ring is opened to give camphoronic acid, one carbon atom is readily lost. Using this as a working hypothesis, then there are only two reasonable structures for camphoric

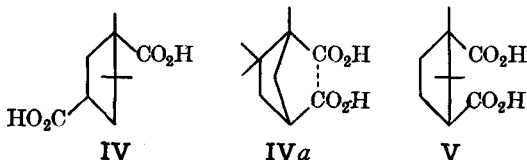

acid, IV and V. IV may be rewritten as IVa, and since the two carboxyl groups are produced from the  $-\text{CH}_2\cdot\text{CO}-$  group in camphor, the precursor of IVa (*i.e.*, camphor) will contain a six-membered ring with a *gem*-dimethyl group. This structure cannot account for the conversion of camphor into *p*-cymene. On the other hand, V accounts for all the facts given in the foregoing discussion. Bredt therefore assumed that V was the structure of camphoric acid, and that VI was the structure of camphor, and proposed the following reactions to show the relationships between camphor, camphoric acid and camphoronic acid.

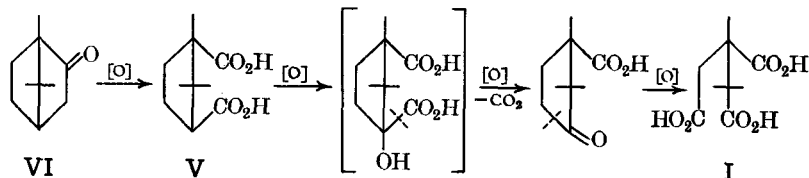

Bredt, however, realised that if camphor had structure VII, then all the foregoing facts would be equally satisfied, but he rejected VII in favour of VI for a number of reasons. One simple fact that may be used here for

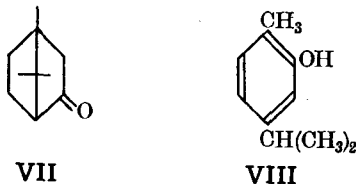

rejection of VII is that camphor gives carvacrol, VIII, when distilled with iodine. The formation of this compound can be expected from VI but not from VII.

Formula VI for camphor was accepted with reserve at the time when Bredt proposed it (in 1893), but by 1903 all the deductions of Bredt were confirmed by the syntheses of camphoronic acid, camphoric acid and camphor.

**Synthesis of ( $\pm$ )-camphoronic acid (Perkin, junior, and Thorpe, 1897).**

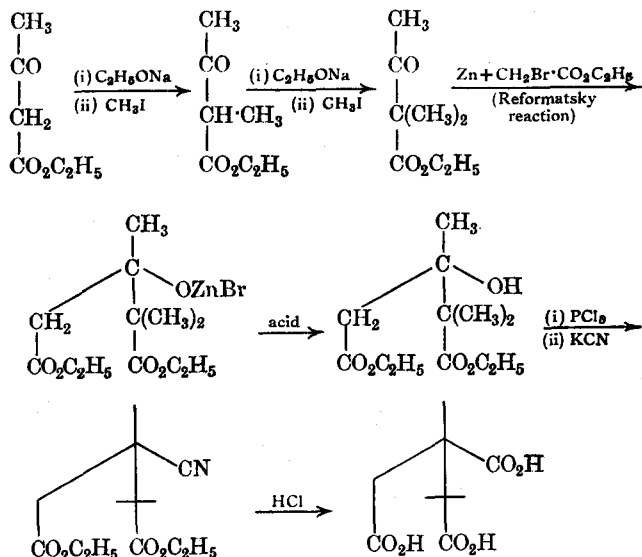

**Synthesis of ( $\pm$ )-camphoric acid (Komppa, 1903).** Komppa (1899) first synthesised  $\beta$ : $\beta$ -dimethylglutaric ester as follows, starting with mesityl

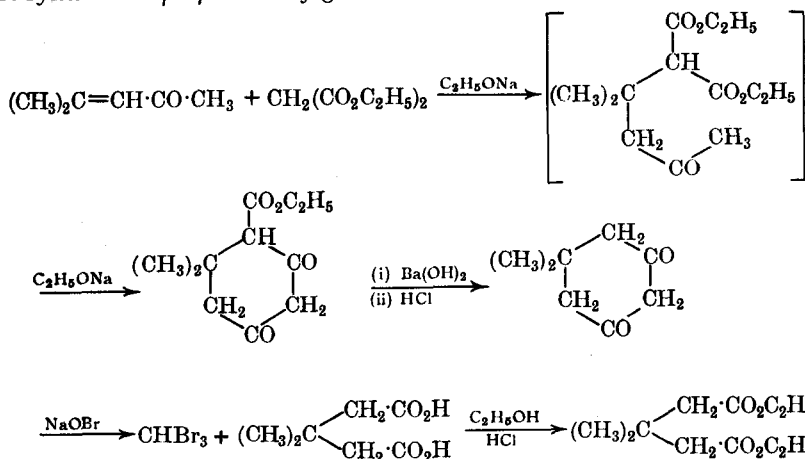

oxide and ethyl malonate. The product obtained was 6:6-dimethylcyclohexane-2:4-dione-1-carboxylic ester (this is produced first by a Michael condensation, followed by a Dieckmann reaction). On hydrolysis, followed by oxidation with sodium hypobromite,  $\beta$ : $\beta$ -dimethylglutaric acid was obtained (*cf.* carone, §21).

Komppa (1903) then prepared camphoric acid as follows:

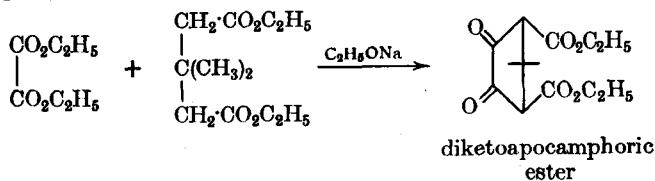

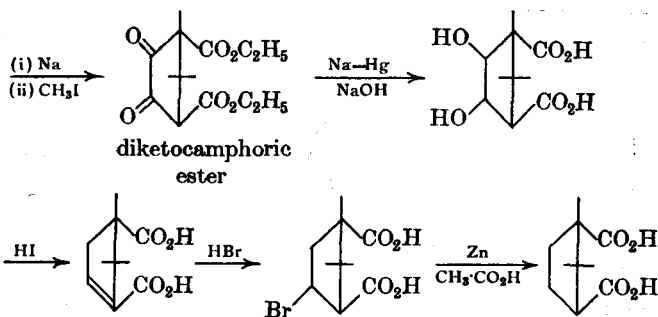

The structure given for camphoric acid can exist in two geometrical isomeric forms, *cis* and *trans*, neither of which has any elements of symmetry. Thus four optically active forms are possible; all are known, and correspond to the (+)- and (-)-forms of camphoric acid and *isocamphoric* acid. Since camphoric acid forms an anhydride, and *isocamphoric* acid does not, the former is the *cis*-isomer, and the latter the *trans*- (§5 i. IV).

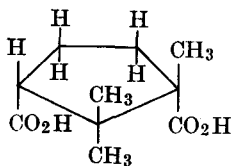

camphoric acid,  
m.p. 187°

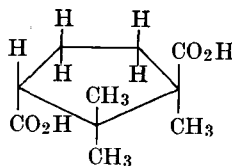

*iso*-camphoric acid,  
m.p. 171-172°

**Synthesis of camphor** (Haller, 1896). Haller started with camphoric acid prepared by the oxidation of camphor, but since the acid was synthesised later by Komppa, we now have a total synthesis of camphor.

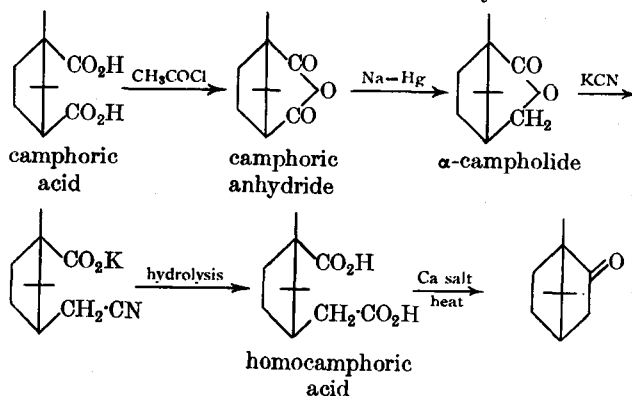

This is *not* an unambiguous synthesis, since the campholide obtained might have had the structure IX (this is actually β-campholide).

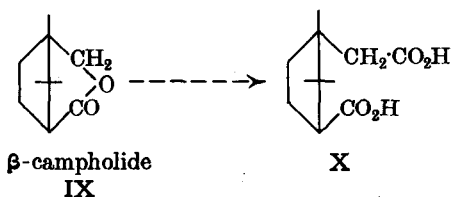

In this case, homocamphoric acid would have had structure X, and this would have given camphor with structure VII which, as we have seen, was rejected. Sauers (1959) has now oxidised camphor directly to  $\alpha$ -campholide by means of peracetic acid. It is also of interest to note that Otvös *et al.* (1960) have shown, using labelled  $-\text{CH}_2\cdot\text{C}^*\text{O}_2\text{H}$  ( $^{14}\text{C}$ ), that in the pyrolysis of the calcium salt of homocamphoric acid to camphor, it is the labelled carboxyl group that is lost.

**Stereochemistry of camphor.** Camphor has two dissimilar asymmetric carbon atoms (the same two as in camphoric acid), but only one pair of enantiomorphs is known. This is due to the fact that only the *cis*-form is possible; *trans* fusion of the *gem*-dimethylmethylene bridge to the cyclohexane ring is impossible. Thus only the enantiomorphs of the *cis*-isomer are known (*cf.*  $\alpha$ -pinene, §22a).

Camphor and its derivatives exist in the boat conformation. Since the *gem*-dimethyl bridge must be *cis*, the cyclohexane ring must have the boat form (see also §23b for the usual way of drawing these conformations; the viewing point is different):

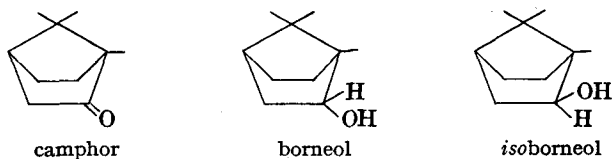

**Some derivatives of camphor.** The positions of substituent groups in camphor are indicated by numbers or by the Greek letters  $\alpha$  (= 3),  $\beta$  or  $\omega$  (= 10) and  $\pi$  (= 8 or 9). When (+)-camphor is heated with bromine at  $100^\circ$ ,  $\alpha$ -bromo-(+)-camphor is produced. This, on warming with sulphuric acid, is converted into  $\alpha$ -bromo-(+)-camphor- $\pi$ -sulphonic acid which,

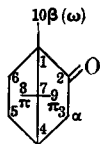

on reduction, forms (+)-camphor- $\pi$ -sulphonic acid. ( $\pm$ )-Camphor- $\pi$ -sulphonic acid is obtained by the sulphonation of (+)-camphor with fuming sulphuric acid; under these conditions, (+)-camphor is racemised. On the other hand, sulphonation of (+)-camphor with sulphuric acid in acetic anhydride solution produces (+)-camphor- $\beta$ -sulphonic acid. These various (+)-camphorsulphonic acids are very valuable reagents for resolving racemic bases (§10 *iv.* II).

**Commercial preparation of camphor.** Synthetic camphor is usually obtained as the racemic modification. The starting material is  $\alpha$ -pinene, and the formation of camphor involves the Wagner-Meerwein rearrangements (see §23d). Scheme (i) is the earlier method, and (ii) is the one that is mainly used now.

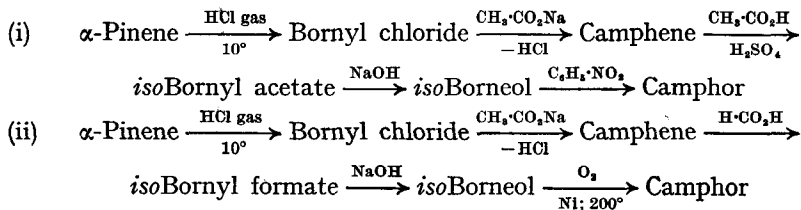

§23b. **Borneols**,  $C_{10}H_{18}O$ . There are two stereoisomeric compounds of the formula  $C_{10}H_{18}O$ ; these correspond to **borneol** and **isoborneol**, and both are known in the (+)- and (-)-forms. The borneols occur widely distributed in essential oils, but it appears that the *isoborneols* have been isolated from only one essential oil. Borneol and *isoborneol* are secondary alcohols, and the evidence now appears to be conclusive that borneol has the *endo*-configuration in which the *gem*-dimethyl bridge is above the plane

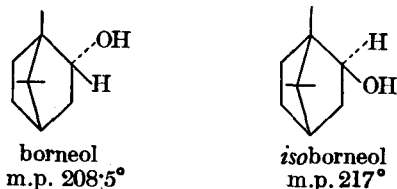

of the *cyclohexane* ring and the hydroxyl group is below the plane. *iso*-Borneol has the *exo*-configuration in which the bridge and the hydroxyl group are both above the plane of the *cyclohexane* ring (see also §23a).

Kwart *et al.* (1956) have now obtained direct evidence on the configuration of bornyl chloride. Bornyl dichloride (I), the structure of which has been established by Kwart (1953), is converted into bornyl chloride (II) by sodium amalgam and ethanol, and into camphane (III) by sodium and ethanol.

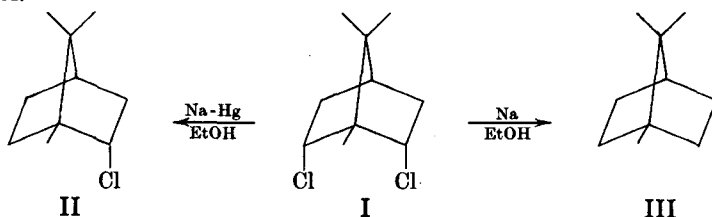

Both borneol and *isoborneol* are produced when camphor is reduced, but the relative amounts of each are influenced by the nature of the reducing agent used, *e.g.*, electrolytic reduction gives mainly borneol, whereas catalytic hydrogenation (platinum) gives mainly *isoborneol*; *isoborneol* is also the main product when aluminium *isopropoxide* is used as the reducing agent (the Meerwein-Ponndorf-Verley reduction; see Vol. I). Borneol is converted into a mixture of bornyl and *isobornyl* chlorides by the action of phosphorus pentachloride. Borneol and *isoborneol* are both dehydrated to camphene (§23c), but the dehydration occurs more readily with *isoborneols* than with borneol. Both alcohols are oxidised to camphor, but whereas borneol can be dehydrogenated to camphor by means of a copper catalyst, *isoborneol* cannot.

§23c. **Camphene and Bornylene**. **Camphene**,  $C_{10}H_{16}$ , m.p. 51–52°, occurs naturally in the (+)-, (-)- and (±)-forms. It may be prepared by the removal of a molecule of hydrogen chloride from bornyl and *isobornyl* chlorides by means of sodium acetate, or by the dehydration of the borneols with potassium hydrogen sulphate. These methods of preparation suggest that camphene contains a double bond, and this is supported by the fact that camphene adds on one molecule of bromine or one molecule of hydrogen chloride. Oxidation of camphene with dilute nitric acid produces carboxyapocamphoric acid,  $C_{10}H_{14}O_6$ , and apocamphoric acid,  $C_9H_{14}O_4$  (Marsh *et al.*, 1891). The formation of the former acid, which contains the same number of carbon atoms as camphene, implies that the double bond in camphene is in a ring; and the fact that carboxyapocamphoric acid is converted into

apocamphoric acid when heated above its melting point implies that the former contains two carboxyl groups attached to the same carbon atom

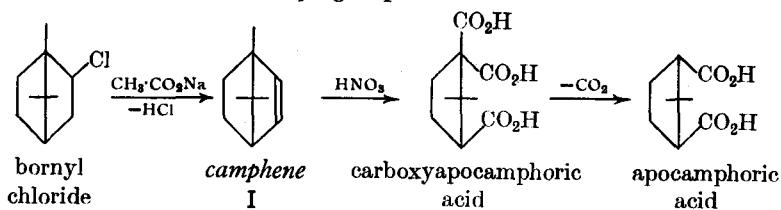

(*cf.* malonic ester syntheses). These facts were explained by giving camphene the formula shown (I). The structure of apocamphoric acid was later proved by synthesis (Komppa, 1901; *cf.* camphoric acid, §23a).

This structure for camphene, however, was opposed by Wagner. The oxidation of camphene with dilute permanganate gives camphene glycol,  $C_{10}H_{16}(OH)_2$  [Wagner, 1890]. This glycol is saturated, and so camphene is a bicyclic compound (so, of course, is structure I). On further oxidation of camphene glycol, Wagner (1896, 1897) obtained camphenic acid,  $C_{10}H_{16}O_4$  (a dibasic acid), and camphenylic acid,  $C_{10}H_{16}O_3$  (a hydroxy-monobasic acid), which, on oxidation with lead dioxide, gave camphenilone,  $C_9H_{14}O$  (a ketone). According to Wagner, it was difficult to explain the formation of these compounds if camphene had structure I. Wagner (1899) therefore suggested that camphene is formed by a molecular rearrangement when the borneols or bornyl chlorides are converted into camphene, and proposed structure II for camphene (see also §23d).

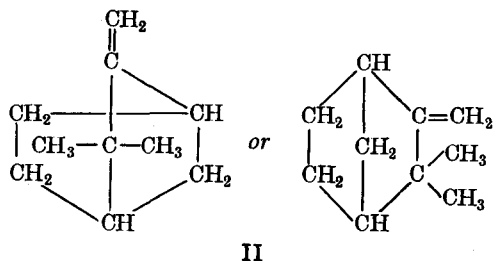

With this formula, the formation of camphene glycol, camphenylic acid and camphenilone could be explained as follows:

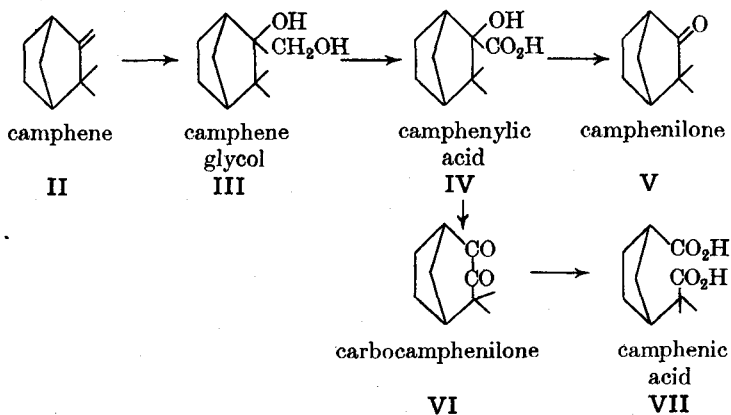

Although it was easy to explain the formation of III, IV and V, it was difficult to explain the formation of VII. The formation of VII was ex-



plained by later workers, who suggested it was produced *via* carbocamphenilone, VI. Another difficulty of the camphene formula, II, is that it does not explain the formation of apocamphoric acid when camphene is oxidised with nitric acid (see above). The course of its formation has been suggested by Komppa (1908, 1911), who proposed a mechanism involving a Wagner rearrangement.

Structure II for camphene is supported by the fact that treatment of bornyl iodide with ethanolic potassium hydroxide at 170° gives **bornylene**,  $C_{10}H_{16}$  (m.p. 98°), as well as camphene (Wagner *et al.*, 1899). Bornylene is readily oxidised by permanganate to camphoric acid; it therefore follows that bornylene has the structure I, the structure originally assigned to camphene; no rearrangement occurs in the formation of bornylene.

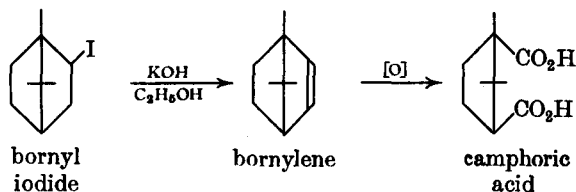

Ozonolysis of camphene gives camphenilone and formaldehyde (Harries *et al.*, 1910); these products are in keeping with the Wagner formula for camphene.

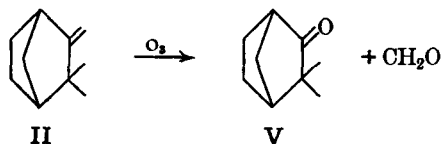

Further support for this structure for camphene is afforded by the work of Buchner *et al.* (1913). These workers showed that camphene reacts with diazoacetic ester, and when the product is hydrolysed and then oxidised,

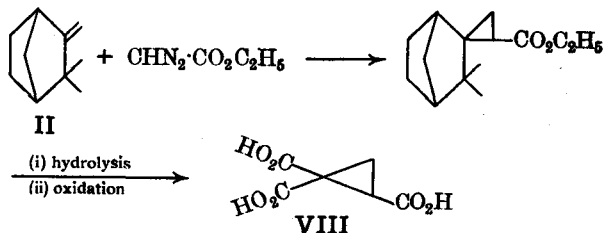

*cyclopropane-1 : 1 : 2-tricarboxylic acid*, VIII, is produced. VIII is to be expected from structure II, but not from I; I (bornylene) would give *cyclopropane-1 : 2 : 3-tricarboxylic acid*, IX.

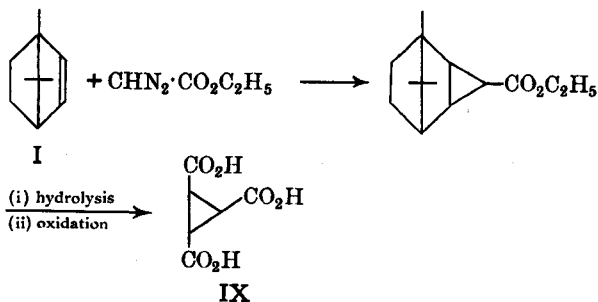

Lipp (1914) has synthesised camphenic acid (VII), and showed that it has the structure assigned to it by Wagner. Finally, camphene has been synthesised as follows (Diels and Alder, 1928–1931).

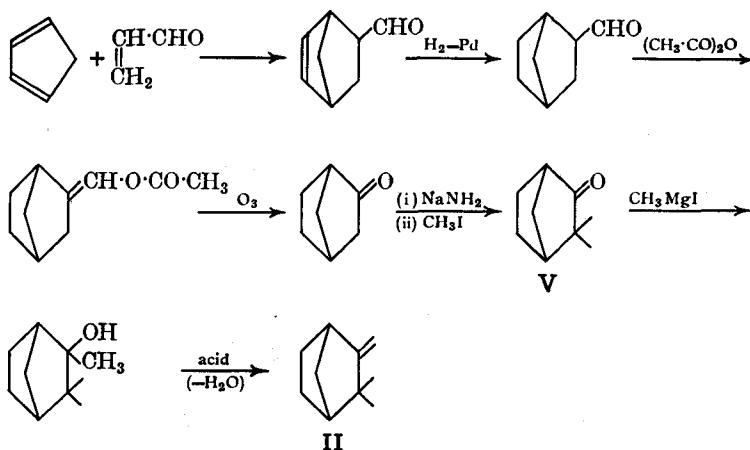

§23d. **Wagner–Meerwein rearrangements.** Wagner, as we have seen, proposed a molecular rearrangement to explain the formation of camphene from the borneols and bornyl chlorides. Wagner also recognised that a molecular rearrangement occurred when  $\alpha$ -pinene was converted into bornyl chloride. Many other investigations concerning rearrangements in the terpene field were carried out by Meerwein and his co-workers, *e.g.*, when  $\alpha$ -pinene is treated in ethereal solution at  $-20^\circ$  with hydrogen chloride, the product is pinene hydrochloride. This is unstable, and if the temperature is allowed to rise to about  $10^\circ$ , the pinene hydrochloride rearranges to bornyl chloride (Meerwein *et al.*, 1922). Rearrangements such as these which occur with bicyclic monoterpenes are known as *Wagner–Meerwein rearrangements*. Furthermore, Meerwein extended the range of these rearrangements to compounds outside bicyclic terpenes; these compounds were monocyclic. Finally, the range was extended to acyclic compounds, the classical example being that of *neopentyl* into *t*-pentyl compounds (Whitmore *et al.*, 1932- ).

All of these rearrangements conform to a common pattern, ionisation to a carbonium ion followed by rearrangement. Most rearrangements in the terpene field involve a change in ring structure, and in a few cases the migration of a methyl group. All of these rearrangements are examples of the 1,2-shifts (Vol. I, Ch. V).

The following are examples, and the details of the mechanisms are discussed later; (but see Vol. I for a discussion of example v).

(i) *The conversion of  $\alpha$ -pinene hydrochloride into bornyl chloride.*

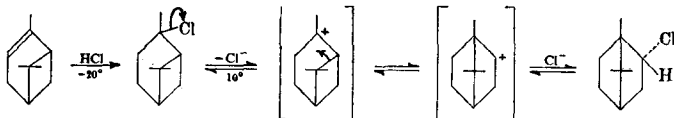

(ii) *The conversion of camphene hydrochloride into isobornyl chloride.*

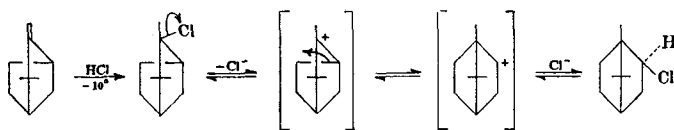

(i) and (ii) are of particular interest since both appear to proceed through the same carbonium ion. Why the epimers should be obtained is not certain (but see later).

(iii) *The dehydration of borneol to camphene (with acids).*

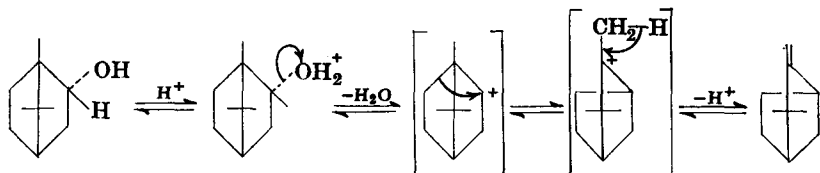

(iv) *The racemisation of camphene hydrochloride.*

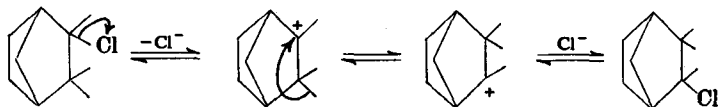

(v) *Rearrangements in the neopentyl system; e.g., the action of hydrobromic acid on neopentyl alcohol to give *t*-pentyl bromide.*

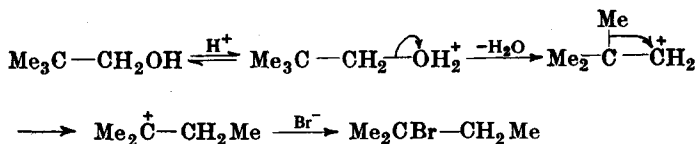

**Evidence for the intermediate formation of a carbonium ion in the Wagner-Meerwein rearrangement.** Meerwein *et al.* (1922), in their detailed investigation of the reversible conversion of camphene hydrochloride into *iso*-bornyl chloride (example ii), concluded that the first step was ionisation, and this was then followed by rearrangement of the carbonium ion:

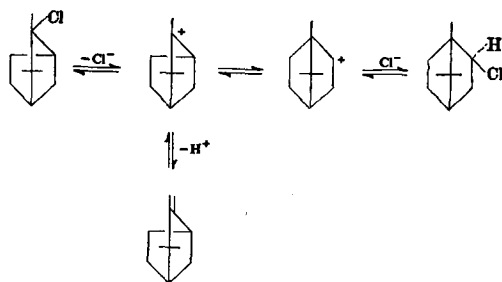

Their evidence for this mechanism was that the rate of the rearrangement was first order, and that the rate depended on the nature of the solvent, the rate being faster the greater the ionising power of the solvent. The order observed for some solvents was:

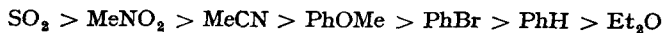

This dependence of rate on solvent was more clearly shown by also studying the solvolysis rates of triphenylmethyl chloride in the same solvents. It was found that the rate of the rearrangement of camphene hydrochloride was faster in those solvents in which triphenylmethyl chloride undergoes solvolysis more readily. Meerwein also found that the rearrangement was strongly catalysed by Lewis acids such as stannic chloride, ferric chloride, etc. All of these form complexes with triphenylmethyl chloride. Furthermore, halides such as phosphorus trichloride and silicon tetrachloride, which do not form complexes with triphenylmethyl chloride, did not catalyse the rearrangement. Further evidence

by Meerwein *et al.* (1927) and by Ingold (1928) also supports the mechanism given above.

Meerwein, however, recognised a difficulty in his proposed mechanism. The carbonium ion formed in the rearrangement of camphene hydrochloride would presumably be the same as that formed in the rearrangement of pinene hydrochloride to bornyl chloride (example i). The reason why the epimers are obtained is not certain; one possibility is that the ions are *not* the same, and as we shall see later, the ions are not identical if we assume there is neighbouring group participation producing a non-classical carbonium ion.

Bartlett *et al.* (1937, 1938) showed that the rearrangement of camphene hydrochloride in non-hydroxylic solvents is strongly catalysed by hydrogen chloride, and pointed out that the formation of *isobornyl* chloride requires a Walden inversion at the new asymmetric carbon atom. According to these authors, the function of the hydrochloric acid is to help the ionisation of the chloride ion (from the camphene hydrochloride). Evidence for this is that phenols have a catalytic effect on the rearrangement rate of camphene hydrochloride, and that the order of this catalytic activity of substituted phenols is the same as the order of the increase in acid strength of hydrogen chloride which phenols promote in dioxan as solvent. These catalytic effects were explained by Bartlett *et al.* (1941) as being due to hydrogen bonding between the phenolic hydroxyl group and the receding chloride ion.

Nevell *et al.* (1939) suggested that the type of resonance hybrid Z is involved in the rearrangement. Thus the hydrogen chloride-catalysed reaction in the inert solvents used would produce an ion-pair  $[Z^+][HCl_2^-]$  (§2e. III).  $Z^+$  can



now react with  $HCl_2^-$  at position 1 to regenerate camphene hydrochloride, or at position 2 to give *isobornyl* chloride. This interpretation is supported by experimental work.

(i) Nevell *et al.* found that the rate of radioactive chlorine ( $^{36}Cl$ ) exchange between  $HCl^*$  and camphene hydrochloride is 15 times faster than the rate of rearrangement to *isobornyl* chloride. It therefore follows that the rate-determining step of the rearrangement is *not* the ionisation step, but is the reaction of the bridged-ion with  $HCl_2^-$  at position 2. It also follows, from the principle of microscopic reversibility (Vol. I), that the rate-determining step of the rearrangement of *isobornyl* chloride back to camphene hydrochloride is the reaction with hydrogen chloride to produce the ion-pair directly.

(ii) On the basis of the bridged-ion being an intermediate in the rearrangement in inert solvents and also for solvolytic reactions of both camphene hydrochloride and *isobornyl* chloride, then both isomers should give the *same* products. Meerwein *et al.* (1922) found that methanolysis, in the cold, of camphene hydrochloride gave at first the *t*-methyl ether (attack at position 1) and this, on long standing, gave *isobornyl* methyl ether. *isoBornyl* chloride also gave *isobornyl* methyl ether, but in this case the reaction was slower. These results can be explained by the presence of the liberated hydrogen chloride which would make the methanolysis reversible.

(iii) Neighbouring group participation in solvolytic reactions of camphene hydrochloride would be expected to accelerate these reactions (anchimeric assistance) as compared with the formation of a classical carbonium ion intermediate. This will be so because the formation of the bridge will assist the expulsion of the chloride ion. Hughes, Ingold *et al.* (1951) have found that the ethanolysis of camphene hydrochloride is 6000 times faster (at  $0^\circ$ ) than the corresponding reaction with *t*-butyl chloride. Also, from the reaction rates of the solvolysis of 1-chloro-1-methylcyclopentane, it followed that camphene hydrochloride is 370 times more reactive than this cyclopentyl derivative. Purely on the basis of ring strain, the camphene compound should have been *less* reactive. Thus the high reactivity of the camphene compound is very strong evidence for neighbouring group participation.

The relative rates of solvolysis of *cyclopentyl* chloride, bornyl chloride, and *isobornyl* chloride (in 80 per cent. ethanol at 85°) are respectively 9.4, 1.0 and 36,000 (Roberts *et al.*, 1949; Winstein *et al.*, 1952). This very large difference between the behaviour of bornyl and *isobornyl* chlorides is readily explained by neighbouring group participation. In *isobornyl* chloride the methylene group that forms the bridged ion is *trans* to the chloride ion ejected and so can readily

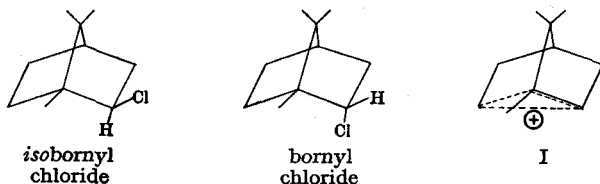

attack the C<sup>+</sup> (of the C—Cl) at the rear, thereby assisting ionisation; this neighbouring group participation cannot occur with bornyl chloride. Various representations of this bridged-ion are possible; I has been proposed by Winstein *et al.* (1952).

Very strong evidence for the participation of a neighbouring saturated hydrocarbon radical has been obtained by Winstein *et al.* (1952) in their detailed examination of some reactions of the parent norbornyl systems.

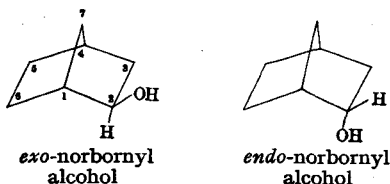

These authors showed that the relative rates of acetolysis of the brosylates (*p*-bromobenzenesulphonates) of *exo/endo* norbornyl alcohols in acetic acid at 25° are 350/1. The explanation offered for the large relative rate of the *exo*-isomer acetolysis was neighbouring group participation to form the non-classical carbonium ion (Ia). As the OBs<sup>-</sup> ion is leaving from the front, the neighbouring group (group C<sub>6</sub>) can attack from the rear to form the bridged-ion. This

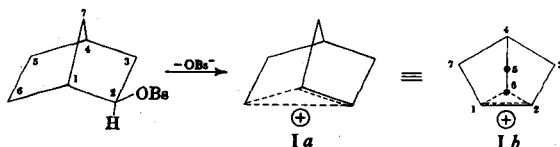

sequence is not possible as such for the *endo*-compound, and so the latter reacts far more slowly. Further support for the formation of (Ia) is as follows. This ion has a plane of symmetry (see Ib) and hence is optically inactive. It has been shown that solvolysis of *exo*-norbornyl brosylate in aqueous acetone, ethanol or acetic acid gives only *exo*-products, but in these products the carbon atoms have become "shuffled" (see below). Winstein *et al.* (1952) also showed that acetolysis of optically active *exo*-norbornyl brosylate gave racemic *exo*-norbornyl acetate. Attack must be from the back of the CH<sub>2</sub> bridge and so this results in the *exo*-product; also, since positions 1 and 2 are equivalent, equal amounts of the enantiomorphs (*i.e.*, racemate) will be produced.

When *endo*-norbornyl brosylate undergoes acetolysis, ionisation of the OBs<sup>-</sup> group leaves the *endo*-norbornyl carbonium ion. This is probably originally the

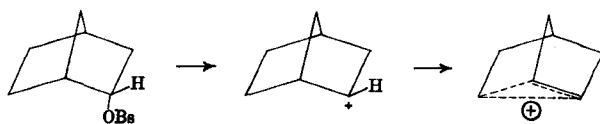

classical carbonium ion, but it then rearranges to the more stable *exo*-bridged-ion. The formation of the latter is shown by the fact that acetolysis of the optically active *endo*-brosylate produces racemic *exo*-acetate.

The structure of the bridged carbonium ion, however, appears to be more complicated than that shown by formula (1a). Examination of (1b) shows the equivalence of positions 1 and 2, and of positions 3 and 7. Thus labelling the brosylate with  $^{14}\text{C}$  at positions 2 and 3 should give products equally labelled at positions 1, 2, 3 and 7. Roberts *et al.* (1954) carried out the acetolysis of this labelled *exo*-brosylate, and the tracer atom was found at 1, 2, 3 and 7, but positions 5 and 6 also contained labelled carbon (15 per cent. of the total radioactivity). These results can be explained on the basis that there is also a 1,3-hydride shift from position 2 to position 6. Thus positions 1, 2 and 6 become shuffled to a certain extent, and there is also the same amount of interchange among positions 3, 5 and 7. This raises the question as to whether some ions

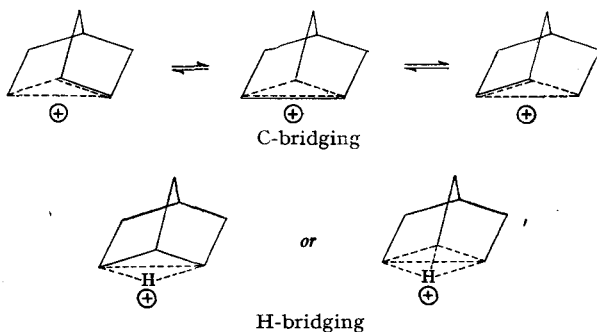

have both carbon and hydrogen bridging. Winstein (1955) has pointed out that the "extra" carbon shuffling (to positions 5 and 6) depends on the nucleophilic activity of the solvent, and is zero for very reactive solvents in which the life of the carbonium ion is short. This suggests that the hydrogen shift competes with the solvent attack and so occurs *after* the formation of the purely carbon bridged-ion.

**§23e. Correlation of configurations of terpenes.** This has been made possible by the work of Fredga on quasi-racemic compounds (see §9a. II). This author has established the following configurations:

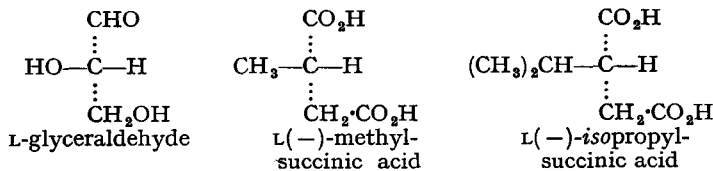

By means of these configurations, combined with various interrelations obtained by oxidative degradations and by molecular rearrangements, it has been possible to correlate the configurations of many mono- and bicyclic terpenes with L-glyceraldehyde, *e.g.*,

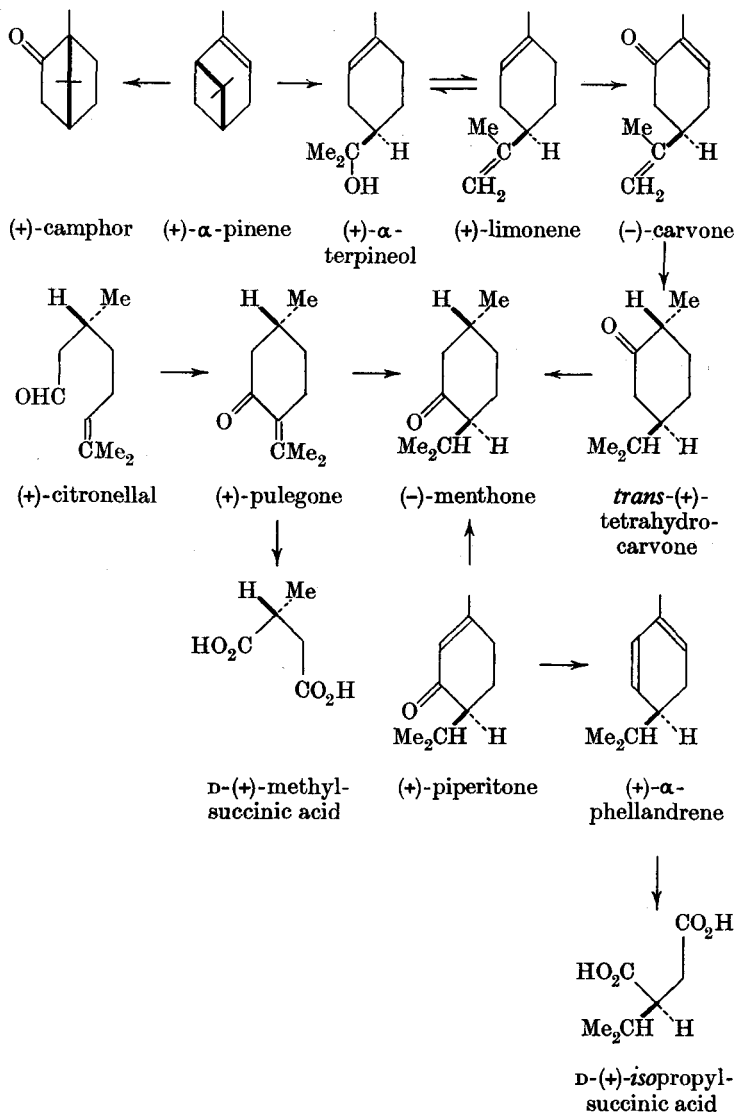

**§24. Fenchane and its derivatives.** The most important natural terpene of this group is **fenchone**; this occurs in oil of fennel. It is a liquid, b.p. 192–193°, and is optically active, both enantiomorphs occurring naturally.

The molecular formula of fenchone is  $C_{10}H_{16}O$ , and the compound behaves as a ketone. When fenchone (I) is reduced with sodium and ethanol, fenchyl alcohol,  $C_{10}H_{18}O$  (II), is produced, and this, on dehydration under the influence of acids, gives  $\alpha$ -fenchene,  $C_{10}H_{16}$  (III). On ozonolysis,  $\alpha$ -fenchene is converted into  $\alpha$ -fenchocamphorone,  $C_9H_{14}O$  (IV), which, on oxidation with nitric acid, forms apocamphoric acid, V, a compound of known structure. This work was carried out by Wallach *et al.* (1890–1898), but it was Semmler (1905) who was the first to assign the correct structure to fenchone; the foregoing reactions may be formulated:

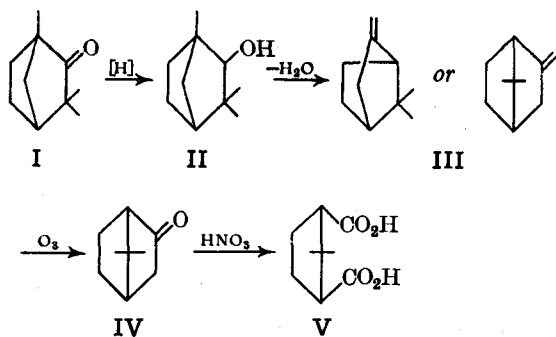

It should be noted that the dehydration of fenchyl alcohol, II, to  $\alpha$ -fenchene, III, occurs *via* a Wagner–Meerwein rearrangement; the mechanism for this reaction may thus be written (*cf.* §23d):

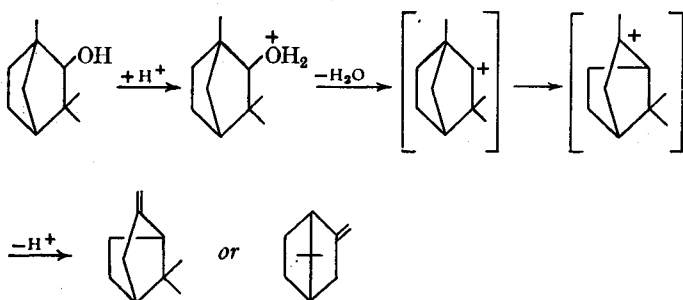

The structure of fenchone has been confirmed by synthesis (Ruzicka, 1917).

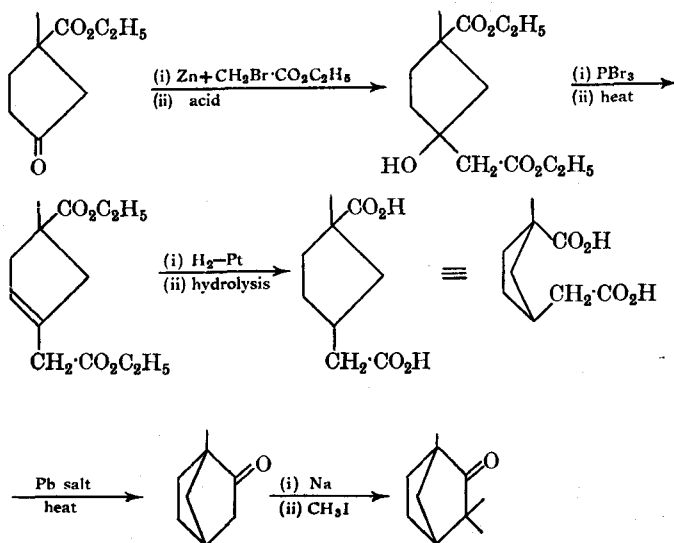



### SESQUITERPENES

**§25. Introduction.** The sesquiterpenes, in general, form the higher boiling fraction of the essential oils; this provides their chief source. Wallach (1887) was the first to suggest that the sesquiterpene structure is built up of three isoprene units; this has been shown to be the case for the majority of the known sesquiterpenes, but there are some exceptions.

The sesquiterpenes are classified into four groups according to the number of rings present in the structure. If we use the *isoprene rule*, then when three isoprene units are linked (head to tail) to form an acyclic sesquiterpene hydrocarbon, the latter will contain *four* double bonds. Each isoprene unit contains *two* double bonds, but one disappears for each pair that is connected:

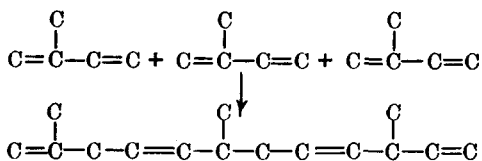

When this open-chain compound is converted into a monocyclic structure, another double bond is utilised in the process, and so monocyclic sesquiterpene hydrocarbons contain three double bonds. In a similar manner, it will be found that a bicyclic structure contains two double bonds, and a tricyclic one. Thus the nature of the sesquiterpene skeleton is also characterised by the number of double bonds present in the molecule. The sesquiterpene hydrocarbon structures may also be distinguished by the calculation of the molecular refractivities for the various types of structures, and then using these values to help elucidate the structures of new sesquiterpenes; *e.g.*, zingiberene (§27a).

Class of sesquiterpene	Number of double bonds	Molecular refractivity
Acyclic . . . . .	4	69.5
Monocyclic . . . . .	3	67.8
Bicyclic . . . . .	2	66.1
Tricyclic . . . . .	1	64.4

This type of information can also be used with the monoterpenes, but in this case it has not been so useful as in the sesquiterpenes. It might be noted here that the non-acyclic members of the sesquiterpenoid group may have rings of various sizes: 4, 5, 6, 7, 9, 10 and 11; and in many of these the rings are fused.

#### ACYCLIC SESQUITERPENES

**§26. Farnesene,  $C_{15}H_{24}$ ,** b.p. 128–130°/12 mm., is obtained by the dehydration of farnesol with potassium hydrogen sulphate (Harries *et al.*,

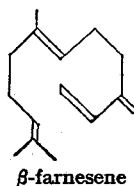
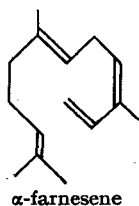

1913). This compound is the  $\alpha$ -isomer, and it has now been shown that the  $\beta$ -isomer occurs naturally (in oil of hops), and Sorm *et al.* (1949, 1950) have assigned it the structure shown.  $\beta$ -Farnesene is also obtained by the dehydration of nerolidol.

§26a. **Farnesol**,  $C_{15}H_{26}O$ , b.p.  $120^\circ/0.3$  mm., occurs in the oil of ambrette seeds, etc. Its structure was elucidated by Kerschbaum (1913) as follows. When oxidised with chromic acid, farnesol is converted into farnesal,  $C_{15}H_{24}O$ , a compound which behaves as an aldehyde. Thus farnesol is a primary alcohol. Conversion of farnesal into its oxime, followed by hydrolysis with acetic anhydride, produces a cyanide which, on hydrolysis with alkali, forms farnesenic acid,  $C_{15}H_{24}O_2$ , and a ketone,  $C_{13}H_{22}O$ . This ketone was then found to be dihydro-*pseudo-ionone* (geranylacetone). In the formation of this ketone, two carbon atoms are removed from its precursor. This reaction is characteristic of  $\alpha : \beta$ -unsaturated carbonyl compounds, and so it is inferred that the precursor, farnesenic acid (or its nitrile), is an  $\alpha : \beta$ -unsaturated compound. Thus the foregoing facts may be formulated as follows, on the basis of the known structure of geranylacetone.

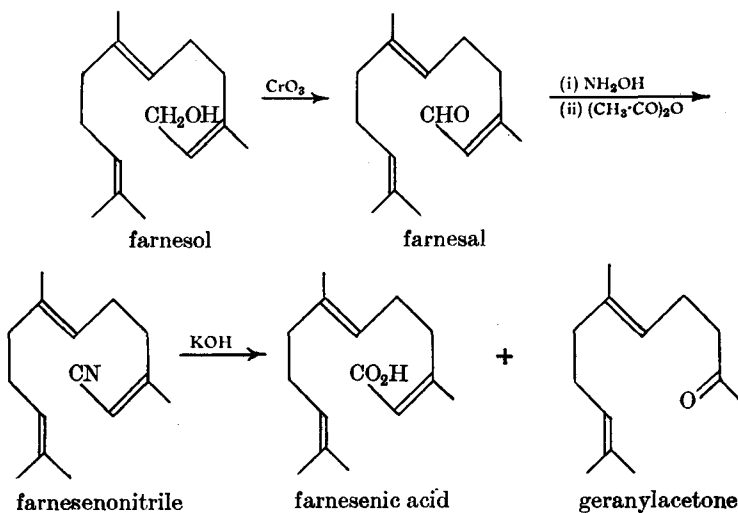

Kerschbaum's formula has been confirmed by Harries *et al.* (1913), who obtained acetone, lævulaldehyde and glycolaldehyde on the ozonolysis of farnesol.

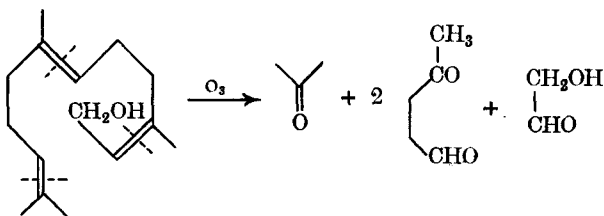

Ozonolysis, however, also gave some formaldehyde, thus indicating the presence of the *isopropenyl* end-group as well as the *isopropylidene* end-group (but *cf.* citral, §5). Ruzicka (1923) synthesised farnesol (with the *isopropylidene* end-group) by the action of acetic anhydride on synthetic nerolidol (*cf.* linalool, §8).

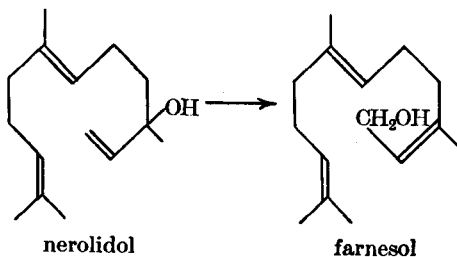

§26b. Nerolidol,  $C_{15}H_{26}O$ , b.p.  $125-127^{\circ}/4-5$  mm., occurs in the oil of neroli, etc., in the (+)-form. Nerolidol is isomeric with farnesol, and Ruzicka (1923) showed that the relationship between the two is the same as that between linalool and geraniol (see §8). Ruzicka (1923) confirmed the structure of nerolidol by synthesis.

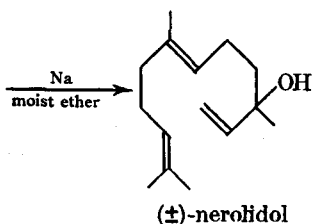
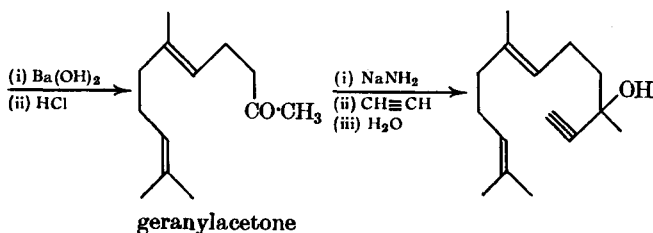
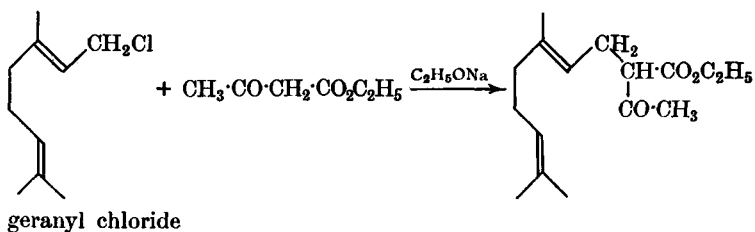

#### MONOCYCLIC SESQUITERPENES

§27. Bisabolene,  $C_{15}H_{24}$ , b.p.  $133-134^{\circ}/12$  mm., occurs in the oil of myrrh and in other essential oils. The structure of bisabolene was determined by Ruzicka *et al.* (1925). Bisabolene adds on three molecules of hydrogen chloride to form bisabolene trihydrochloride, and this regenerates bisabolene when heated with sodium acetate in acetic acid solution. Thus bisabolene contains three double bonds and is therefore monocyclic (see §25). Nerolidol may be dehydrated to a mixture of  $\alpha$ - and  $\beta$ -farnesenes (*cf.* §26). This mixture, on treatment with formic acid, forms a monocyclic sesquiterpene (or possibly a mixture) which combines with hydrogen chloride to form bisabolene trihydrochloride. Removal of these three molecules of

hydrogen chloride (by means of sodium acetate in acetic acid) produces bisabolene; thus bisabolene could be I, II or III, since all three would give the *same* bisabolene trihydrochloride.

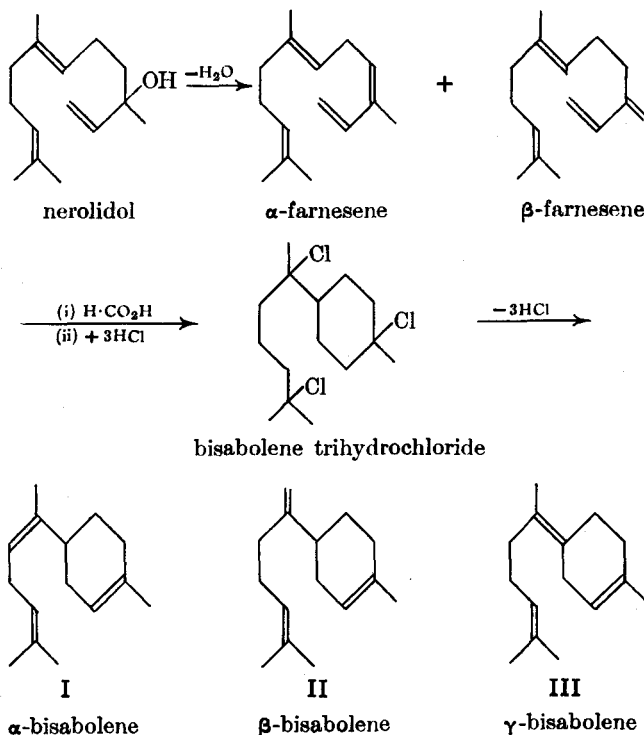

Ruzicka *et al.* (1929) showed that synthetic and natural bisabolene consisted mainly of the  $\gamma$ -isomer (III), since on ozonolysis of bisabolene, the products were acetone, lævulic acid and a small amount of succinic acid. These products are readily accounted for by III; and this structure has been confirmed by synthesis (Ruzicka *et al.*, 1932).

§27a. **Zingiberene**,  $C_{15}H_{24}$ , b.p.  $134^\circ/14$  mm., occurs in the (–)-form in ginger oil. It forms a dihydrochloride with hydrogen chloride, and thus apparently contains two double bonds. The molecular refractivity, however, indicates the presence of three double bonds and, if this be the case, zingiberene is monocyclic (see §25). The presence of these three double bonds is conclusively shown by the fact that catalytic hydrogenation (platinum) converts zingiberene into hexahydrozingiberene,  $C_{15}H_{30}$ . Zingiberene can be reduced by means of sodium and ethanol to dihydrozingiberene,  $C_{15}H_{26}$ ; this indicates that two of the double bonds are probably conjugated (Semmler *et al.*, 1913). Further evidence for this conjugation is afforded by the fact that zingiberene shows optical exaltation, whereas dihydrozingiberene does not. The absorption spectrum of zingiberene also shows the presence of conjugated double bonds (Gillam *et al.*, 1940).

Ozonolysis of zingiberene gives acetone, lævulic acid and succinic acid (Ruzicka *et al.*, 1929). Since these products are also obtained from bisabolene (§27), it appears probable that zingiberene and bisabolene have the same carbon skeleton. Oxidation of dihydrozingiberene, I, with permanganate gives a keto-dicarboxylic acid,  $C_{12}H_{20}O_5$  (II), which, on oxidation

with sodium hypobromite, forms a tricarboxylic acid,  $C_{11}H_{18}O_6$  (III). Thus II must contain a methyl ketone group ( $CH_3 \cdot CO-$ ), and so, if I be assumed as the structure of dihydrozingiberene, the foregoing oxidation reactions may be formulated:

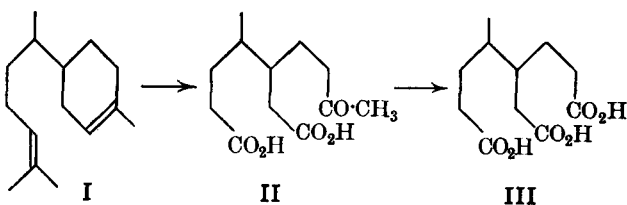

Thus I, with another double bond in conjugation with one already present, will be (probably) the structure of zingiberene. The position of this third double bond was shown as follows (Eschenmoser *et al.*, 1950). Zingiberene forms an adduct with methyl acetylenedicarboxylate, and this adduct (which was not isolated), on pyrolysis, gives 2:6-dimethylocta-2:7-diene and methyl 4-methylphthalate. These reactions can be explained on the assumption that zingiberene has the structure shown below.

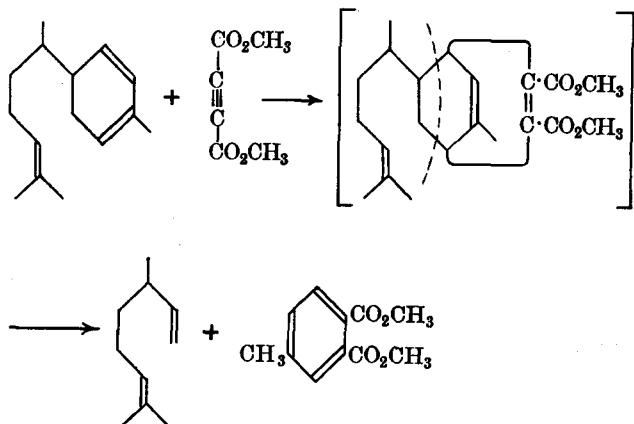

§27b. **Humulene** ( $\alpha$ -caryophyllene),  $C_{15}H_{24}$ , b.p.  $264^\circ$ , is an eleven-membered ring compound which contains three double bonds. Its structure is very closely related to that of caryophyllene (§28c).

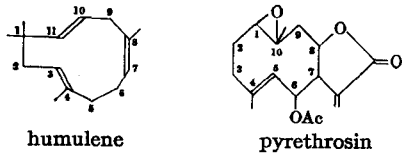

**Pyrethrosin** is also a monocyclic sesquiterpene; it is a  $\gamma$ -lactone which contains a ten-membered ring.

#### BICYCLIC SESQUITERPENES

§28. **Cadinene**,  $C_{15}H_{24}$ , b.p.  $134-136^\circ/11$  mm., occurs in the (-)-form in oil of cubeb, etc. Catalytic hydrogenation converts cadinene into tetrahydrocadinene,  $C_{15}H_{28}$ . Thus cadinene contains two double bonds and is

bicyclic. On dehydrogenation with sulphur, cadinene forms cadalene,  $C_{15}H_{18}$  (Ruzicka *et al.*, 1921). Cadalene does not add on bromine, and forms a picrate. This led to the belief that cadalene was an aromatic compound, and its structure was deduced as follows. Ruzicka assumed that the relationship of farnesol (§26a) to cadinene was analogous to that of geraniol (§7) to dipentene (§13). Furthermore, since dipentene gives *p*-cymene when dehydrogenated with sulphur, then cadalene should be, if the analogy is correct, 1 : 6-dimethyl-4-*isopropyl*naphthalene; thus:

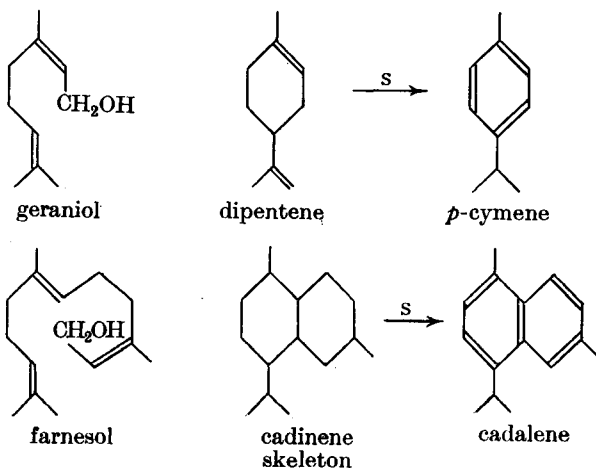

1 : 6-Dimethyl-4-*isopropyl*naphthalene was synthesised by Ruzicka *et al.* (1922), and was found to be identical with cadalene.

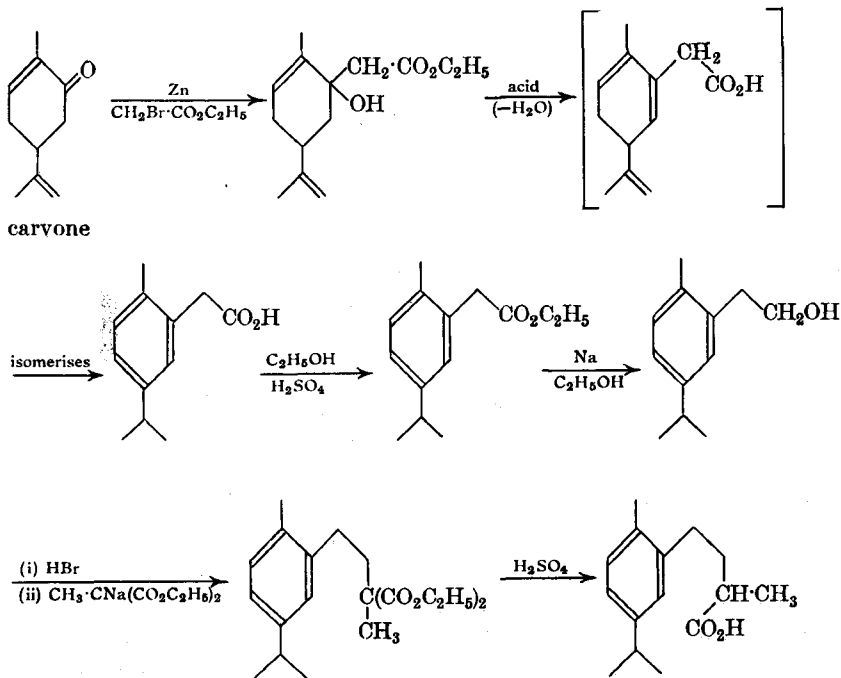

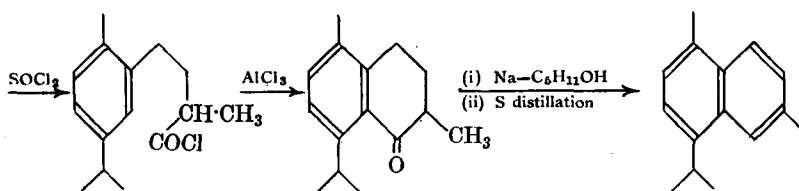

Thus cadinene has the carbon skeleton assumed. The only remaining problem is to ascertain the positions of the two double bonds in cadinene. Since the molecular refractivity shows no optical exaltation, the two double bonds are not conjugated (§11. I); this is supported by the fact that cadinene is not reduced by sodium and amyl alcohol. Ozonolysis of cadinene produces a compound containing the *same* number of carbon atoms as cadinene. The two double bonds are therefore in ring systems, but they cannot be in the *same* ring, since in this case carbon would have been lost on ozonolysis. Ruzicka *et al.* (1924) were thus led to suggest I ( $\alpha$  or  $\beta$ ) for the structure of cadinene, basing it on the relationship of cadinene to copaaene, which had been given structure II by Semmler (1914). I was proposed mainly on the

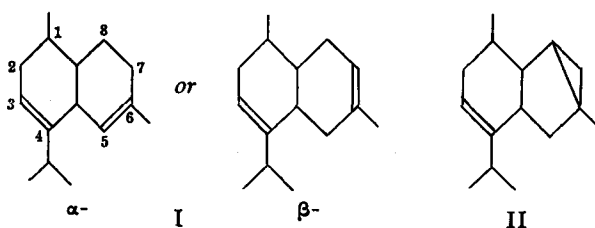

fact that copaaene adds two molecules of hydrogen chloride to form copaaene dihydrochloride, which is *identical* with cadinene dihydrochloride (both the  $\alpha$  and  $\beta$  structures of I would give the *same* dihydrochloride as II). Structure I ( $\alpha$  or  $\beta$ ) was accepted for cadinene until 1942, when Campbell and Soffer re-investigated the problem. These authors converted cadinene into its monoxide and dioxide by means of perbenzoic acid, treated these oxides with excess of methylmagnesium chloride, and then dehydrogenated the product with selenium. By this means, Campbell and Soffer obtained a monomethylcadalene from cadinene monoxide, and a dimethylcadalene from cadinene dioxide. Now the introduction of a methyl group *via* the oxide takes place according to the following scheme:

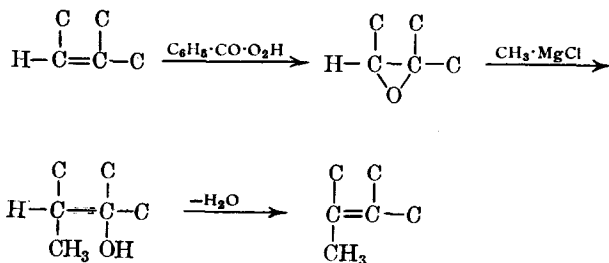

Thus the positions of the additional methyl groups show the positions of the double bonds in cadinene. The Ruzicka formula for cadinene would give dimethylcadalene III (from the  $\alpha$  isomer) or IV (from the  $\beta$ ), and the monomethylcadalenes would be V (from  $\alpha$  or  $\beta$ ), VI (from  $\alpha$ ) and VII (from  $\beta$ ). Campbell and Soffer oxidised their dimethylcadalene, first with chromic acid and then with nitric acid, and thereby obtained pyromellitic acid

(benzene-1:2:4:5-tetracarboxylic acid), VIII. The formation of VIII therefore rules out III as the structure of dimethylcadalene, but IV, with

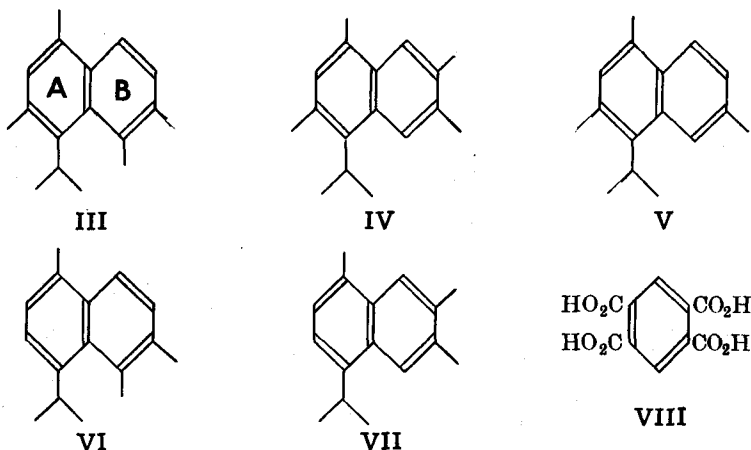

the two methyl groups at positions 6 and 7 in ring B, could give VIII. Therefore the double bond in cadinene in ring B is 6:7. From this it follows that VI is also eliminated. If the double bond in ring A is as in structure I, then dimethylcadalene is IV, and monomethylcadalene is V or VII. Campbell and Soffer synthesised IV and VII, and found that each was different from the methylcadalenes they had obtained from cadinene. Thus IV and VII are incorrect; consequently the double bond in ring A cannot be 3:4. The only other dimethylcadalene which could give VIII on oxidation is IX. This was synthesised, and was found to be identical with the dimethylcadalene from cadinene. Cadinene must therefore be X, and the introduction of one or two methyl groups may thus be formulated as follows:

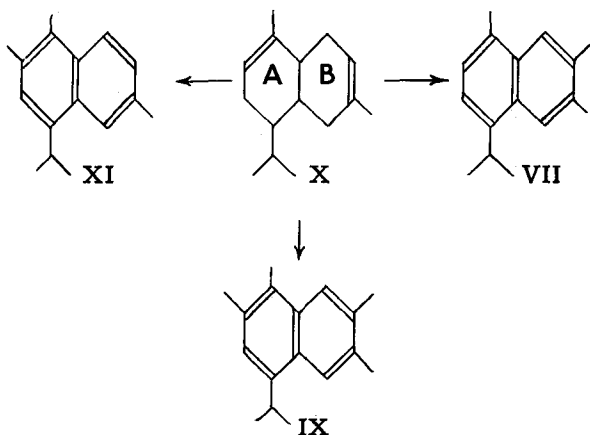

X could give two monoxides (oxidation of ring A or B), and one of these (ring B oxidised) would give VII. This, as pointed out above, was different from the monomethylcadalene actually obtained. Therefore, if X is the structure of cadinene, the monomethylcadalene obtained from cadinene must be XI. XI was synthesised, and was found to be identical with the compound obtained from cadinene. Thus X is the structure of cadinene.



It should be noted, in passing, that this new structure for cadinene has necessitated revision of the structure of copaene. Briggs and Taylor (1947), using a technique similar to that of Campbell and Soffer, have assigned the following structure to copaene.

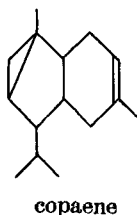

The absolute configurations of the cadinenes (and cadinols) have now been established (Motl *et al.*, 1958; Soffer *et al.*, 1958).

**§28a. Selinenes,  $C_{15}H_{24}$ .** Selinene occurs in celery oil; when treated with hydrogen chloride, it forms a dihydrochloride which, when warmed with aniline, is converted into the compound  $C_{15}H_{24}$ . This is isomeric with selinene, and the natural compound was called  $\beta$ -selinene, and the synthetic isomer  $\alpha$ -selinene (Semmler *et al.*, 1912). Semmler showed that the catalytic hydrogenation of the two selinenes gives the same tetrahydroselinene,  $C_{15}H_{28}$ . Thus they each contain two double bonds, and are bicyclic. Ozonolysis of  $\beta$ -selinene produces a diketone (I) with the loss of two carbon atoms, and oxidation of I with sodium hypobromite gives a tricarboxylic acid (II), with the loss of one carbon atom. From this it follows that I contains a  $CH_3 \cdot CO-$  group. Ozonolysis of  $\alpha$ -selinene gives a diketo-monocarboxylic acid (III) with loss of one carbon atom, and III, on oxidation with sodium hypobromite, loses two carbon atoms to form II. Thus III contains *two*  $CH_3 \cdot CO-$  groups (Semmler *et al.*, 1912). Ruzicka *et al.* (1922) distilled  $\beta$ -selinene with sulphur, and thereby obtained eudalene (see §28b for the evidence for the structure of this compound). If we use the isoprene rule, all the foregoing facts are explained by giving the selinenes the following structures (Ruzicka *et al.*, 1922). The relationship of the selinenes to eudesmol (§28b) confirms the nature of the carbon skeleton given to the selinenes.

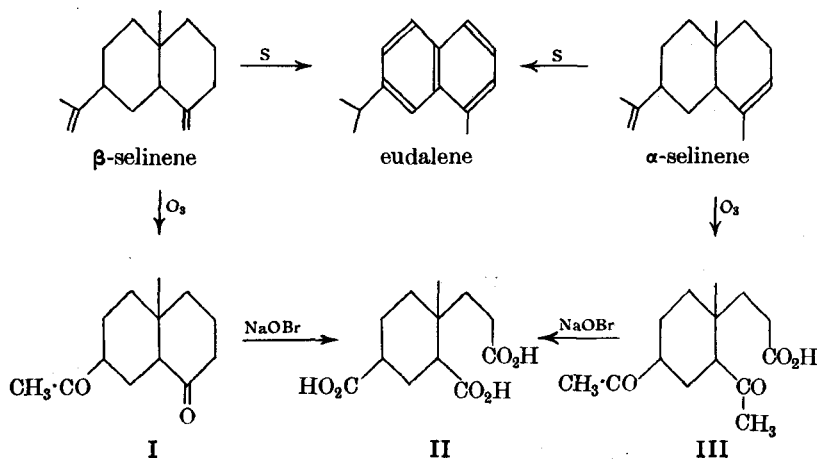

§28b. **Eudesmol**,  $C_{15}H_{26}O$ , occurs in eucalyptus oil. Catalytic hydrogenation converts eudesmol into dihydroeudesmol,  $C_{15}H_{28}O$ . Thus one double bond is present in the molecule, and since eudesmol behaves as a tertiary alcohol, the parent hydrocarbon is  $C_{15}H_{28} \equiv C_nH_{2n-2}$ ; eudesmol is therefore bicyclic. When dehydrogenated with sulphur, eudesmol forms eudalene,  $C_{14}H_{16}$ , and methanethiol (Ruzicka *et al.*, 1922). Eudalene behaved as an aromatic compound (*cf.* cadalene, §28), and its structure was deduced as follows. Since eudalene was a naphthalene derivative, and since it contained one carbon atom less than cadalene, it was thought to be an apocadalene, *i.e.*, cadalene minus one methyl group. Thus eudalene is either 1-methyl-4-isopropyl-naphthalene (IIa) or 7-methyl-1-isopropyl-naphthalene (Ia). To test this hypothesis, Ruzicka oxidised cadalene with chromic acid, and thereby obtained a naphthoic acid,  $C_{15}H_{16}O_2$ , which must

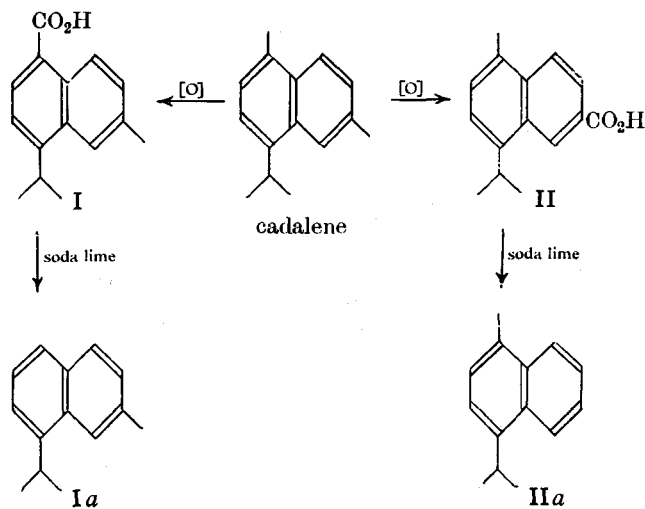

be I or II. Distillation of this acid with soda-lime gives a methylisopropyl-naphthalene which must be Ia or IIa. IIa was synthesised from carvone (the synthesis is the same as for cadalene except that ethyl malonate is used instead of ethyl methylmalonate; see §28). The synthetic compound (IIa) was found to be different from the hydrocarbon obtained by the distillation of the naphthoic acid from cadalene. Thus the apocadalene obtained must be Ia, *i.e.*, 7-methyl-1-isopropyl-naphthalene.

Ruzicka now found that eudalene was not identical with either Ia or IIa. On oxidation, however, eudalene gives the same naphthalenedicarboxylic acid as that which is obtained by the oxidation of Ia. This is only possible if in eudalene the two side-chains in Ia are interchanged, *i.e.*, eudalene is 1-methyl-7-isopropyl-naphthalene; thus:

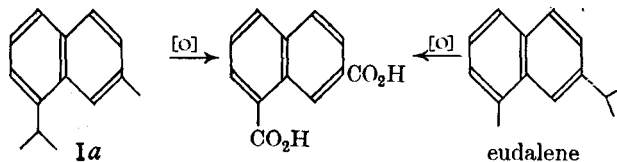

This structure for eudalene was proved by synthesis (Ruzicka *et al.*, 1922).

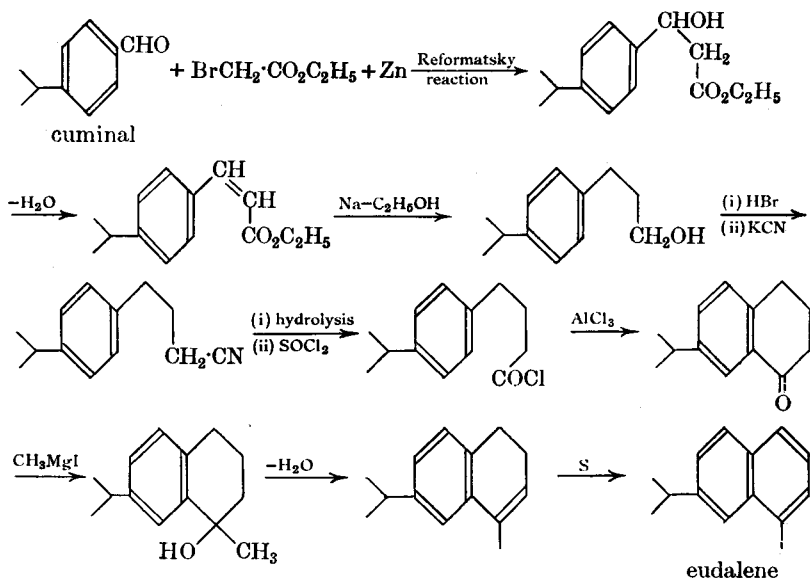

To develop the sesquiterpene carbon skeleton from that of eudalene, it is necessary to introduce one carbon atom in such a position that it is eliminated as methanethiol during the sulphur desulfurization (see above). If we use the *isoprene rule* with the units joined head to tail, then there is only one possible structure that fits the requirements, *viz.*, III (*cf.* §1).

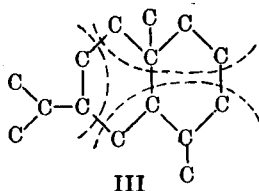

Now  $\beta$ -selinene combines with hydrogen chloride to form selinene dihydrochloride, which is also obtained by the action of hydrogen chloride on eudesmol (Ruzicka *et al.*, 1927, 1931). Since eudesmol contains one double bond and a tertiary alcoholic group, it follows that the double bond must be in the side-chain, and the hydroxyl group in the ring, or *vice versa*, *i.e.*, IV, V or VI is the structure of eudesmol.

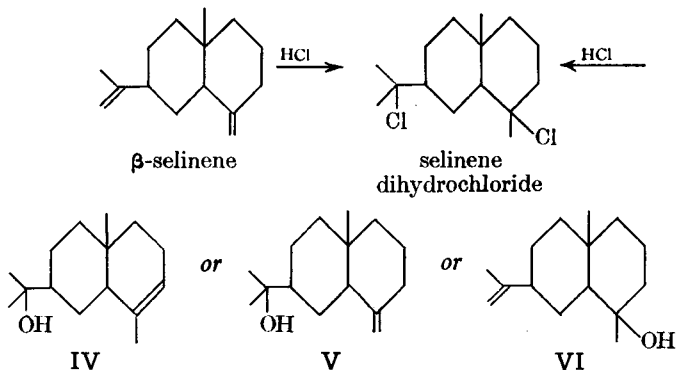

Hydrogenation of eudesmol forms dihydroeudesmol, VII, and this, on treatment with hydrogen chloride followed by boiling with aniline (to remove a molecule of hydrogen chloride), gives dihydroeudesmene, VIII. VIII, on ozonolysis, forms 3-acetyl-5:9-dimethyldecalin, IX, with the elimination of one carbon atom. These results are explained if IV or V is the structure of eudesmol, but not by VI. Thus the hydroxyl group is in the *isopropyl* side-chain.

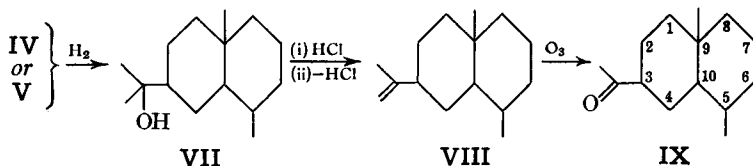

The final problem is to ascertain the position of the double bond in eudesmol, *i.e.*, Is the structure IV or V? Ozonolysis of eudesmol showed that eudesmol is a mixture of IV ( $\alpha$ -eudesmol) and V ( $\beta$ -eudesmol), since *two* products are obtained: a hydroxyketo-acid X, with no loss of carbon, and a hydroxyketone XI, with the loss of one carbon atom (but *cf.* citral, §5).

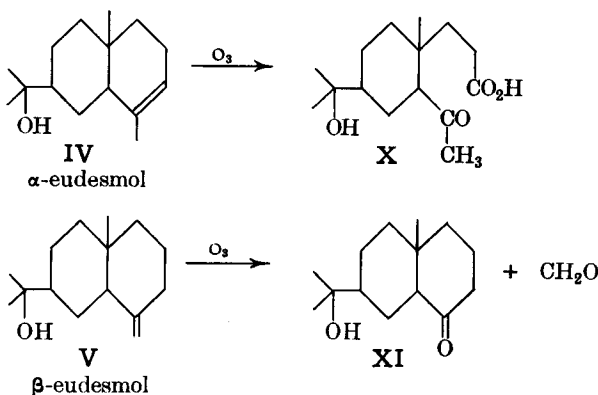

The proportions of these two isomers vary with the source, and McQuillin *et al.* (1956) have succeeded in separating them (*via* their 3:5-dinitrobenzoates), and at the same time have characterised a third, synthetic  $\gamma$ -isomer.

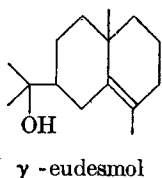

§28c. **Caryophyllene**,  $C_{15}H_{24}$ , b.p. 123–125°/10 mm., is a bicyclic sesquiterpene containing a fused system of a four- and a nine-membered ring. The main source of this compound is the sesquiterpene fraction of oil of cloves, and three isomeric hydrocarbons have been isolated. These were originally called

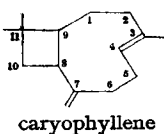

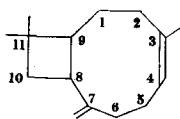

isocaryophyllene

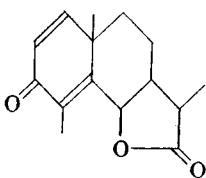

santonin

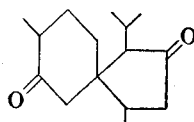

acorone

$\alpha$ -,  $\beta$ -, and  $\gamma$ -caryophyllene, but it has now been shown that the  $\alpha$ -isomer is identical with humulene (§27b); the  $\beta$ -isomer (the main hydrocarbon) is called caryophyllene; and the  $\gamma$ -isomer (which is believed to be produced by thermal isomerisation) is known as *isocaryophyllene*.

**Santonin** is a lactone sesquiterpene of the decalin type (*cf.* pyrethrosin, §27b).

**Acorone** is a most interesting bicyclic sesquiterpene in that it is a carbocyclic spiran, the first example of such a compound to be found in nature.

§29. **Azulenes.** Many essential oils contain blue or violet compounds, or may form such compounds after distillation at atmospheric pressure or dehydrogenation with sulphur, selenium or palladium-charcoal (Ruzicka *et al.*, 1923). These coloured compounds may be extracted by shaking an ethereal solution of the essential oil with phosphoric acid (Sherndal, 1915). These coloured substances are known as **azulenes**. Their molecular formula is  $C_{15}H_{18}$ , and they are sesquiterpenes, the parent substance being azulene,  $C_{10}H_8$ , which contains a seven-membered ring fused to a five-membered one. Azulene has been synthesised as follows (Plattner *et al.*, 1936).

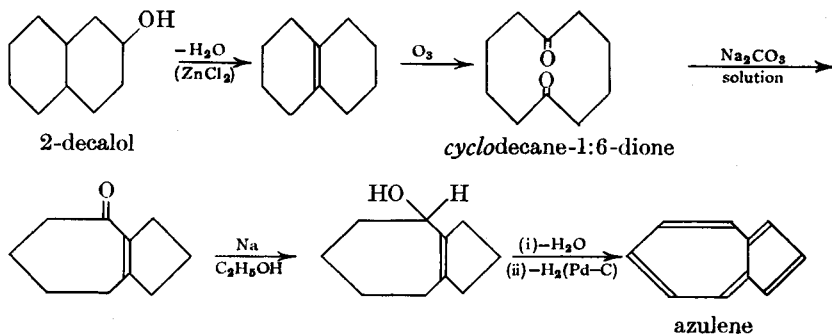

Azulene is a deep blue solid, m.p.  $99^\circ$ ; its systematic name is bicyclo[5 : 3 : 0]-decane. Two sesquiterpenes containing this bicyclodecane skeleton are

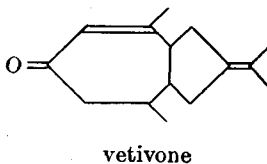
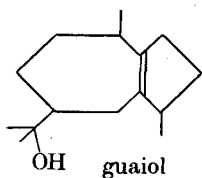

Azulene is a *non-benzenoid* aromatic compound in which  $n = 2$  (aromatics

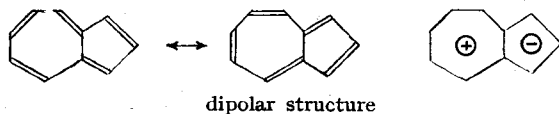

contain  $(4n + 2)$   $\pi$ -electrons in a "circular" system; see Vol. I, Ch. XX). It undergoes many typical aromatic substitution reactions.

## DITERPENES

§30. **Phytol**,  $C_{20}H_{40}O$ , b.p.  $145^{\circ}/0.03$  mm., is an acyclic diterpene; it is produced from the hydrolysis of chlorophyll (§6. XIX), and it also forms part of the molecules of vitamins E and K (see Ch. XVII). The reactions of phytol showed that it is a primary alcohol (Willstätter *et al.*, 1907), and since on catalytic reduction phytol forms dihydrophytol,  $C_{20}H_{42}O$ , it therefore follows that phytol contains one double bond. Thus the parent hydrocarbon is  $C_{20}H_{42}$  ( $\equiv C_nH_{2n+2}$ ), and so phytol is acyclic. Ozonolysis of phytol gives glycolaldehyde and a saturated ketone,  $C_{18}H_{36}O$  (F. Fischer *et al.*, 1928). Thus this reaction may be written:

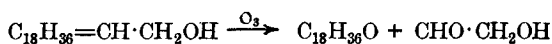

The formula of phytol led to the suggestion that it was composed of four reduced isoprene units. If this were so, and assuming that the units are joined head to tail, the structure of the saturated ketone would be:

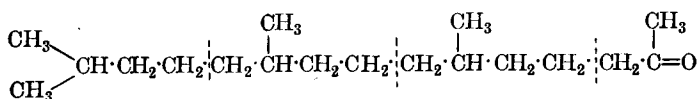

This structure was proved to be correct by the synthesis of the ketone from farnesol (F. Fischer *et al.*, 1928). The catalytic hydrogenation of farnesol, I, produces hexahydrofarnesol, II, which, on treatment with phos-

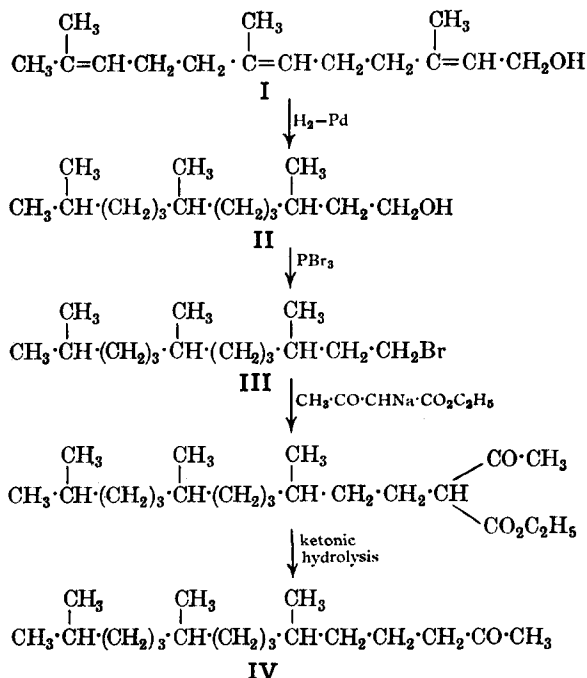

phorus tribromide, gives hexahydrofarnesyl bromide, III. III, on treatment with sodio-acetoacetic ester, followed by ketonic hydrolysis, forms the saturated ketone, IV. This ketone (IV) was then converted into phytol as follows (F. Fischer *et al.*, 1929); it should be noted that the last step involves an allylic rearrangement (*cf.* linalool, §8).

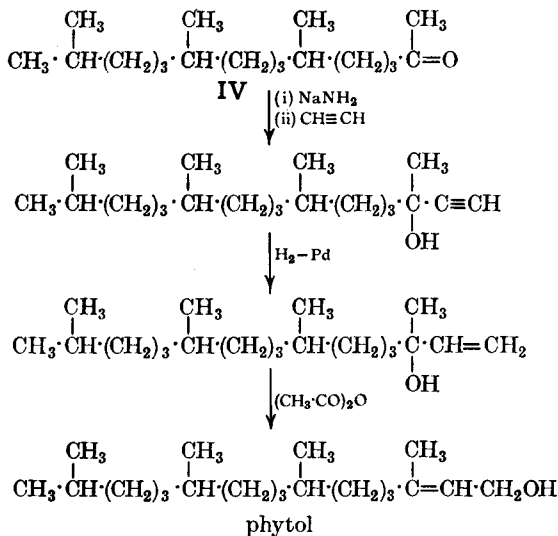

It appears that natural phytol has a very small optical rotation; Karrer *et al.* (1943) have isolated a (+)-form from nettles.

§31. **Abietic acid**,  $\text{C}_{20}\text{H}_{30}\text{O}_2$ , m.p. 170–174°, is a tricyclic diterpene. The non-steam volatile residue from turpentine is known as rosin (or colophony), and consists of a mixture of resin acids which are derived from the diterpenes. Abietic acid is one of the most useful of these acids.

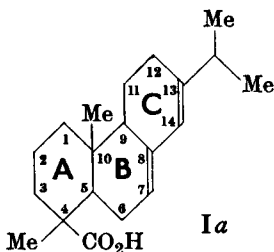
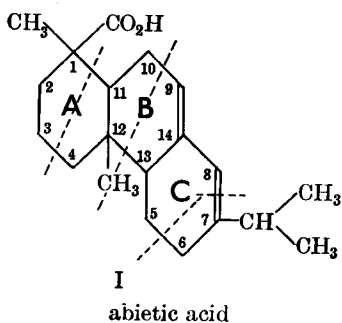

A great amount of work was done before the structure of abietic acid was elucidated. For our purpose it is useful to have the structure of abietic acid as a reference, and then describe the evidence that led to this structure. I is the structure of abietic acid; the system of numbering is shown, and also the four isoprene units comprising it. This way of numbering abietic acid follows the phenanthrene numbering. There has been recently, however, a tendency to bring the numbering of all diterpenes in line with the steroids (§3. XI); this is shown in Ia. In the following discussion I has been used (the reader should work out the change-over for himself).

The general reactions of abietic acid showed that it was a monocarboxylic acid. On dehydrogenation with sulphur, abietic acid gives retene (Vesterberg, 1903); better yields of retene are obtained by dehydrogenating with selenium (Diels *et al.*, 1927), or with palladised charcoal (Ruzicka *et al.*, 1933). Retene,  $\text{C}_{18}\text{H}_{18}$ , m.p. 99°, was shown by oxidative degradation to

be 1-methyl-7-isopropylphenanthrene (Bucher, 1910), and this structure was later confirmed by synthesis, *e.g.*, that of Haworth *et al.* (1932).

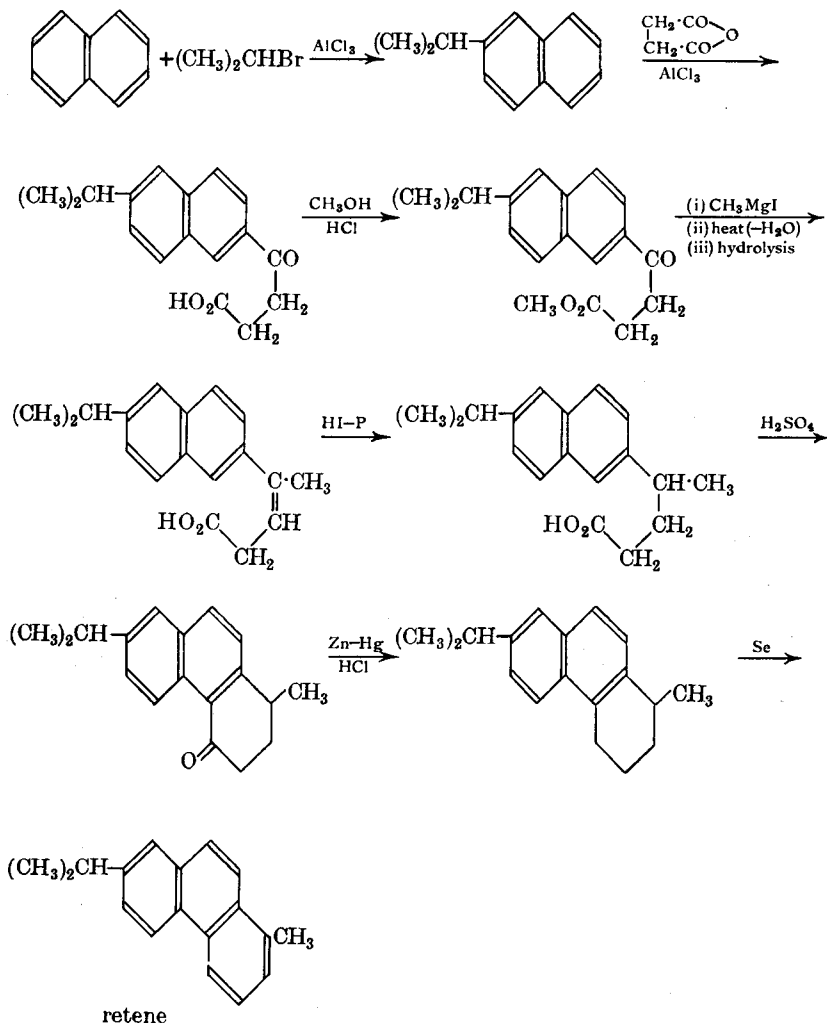

Hence we may assume that this carbon skeleton is present in abietic acid. Thus:

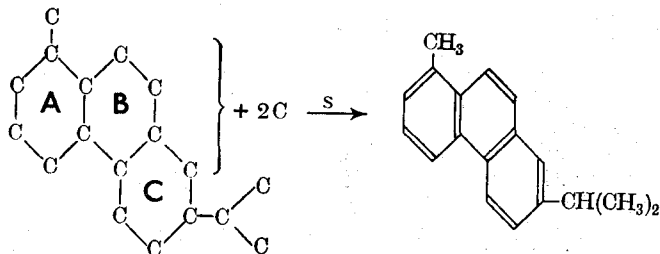

Now it is known that in sulphur dehydrogenations, carboxyl groups and



*angular* methyl groups can be eliminated (see §2 vii. X). It is therefore possible that the two carbon atoms lost may have been originally the carboxyl group (in abietic acid) and an angular methyl group.

Abietic acid is very difficult to esterify, and since this is characteristic of a carboxyl group attached to a tertiary carbon atom, it suggests that abietic acid contains a carboxyl group in this state. This is supported by the fact that abietic acid evolves carbon monoxide when warmed with concentrated sulphuric acid; this reaction is also characteristic of a carboxyl group attached to a tertiary carbon atom.

Catalytic hydrogenation of abietic acid gives tetrahydroabietic acid,  $C_{20}H_{34}O_2$ . Thus abietic acid contains two double bonds; also, since the parent hydrocarbon is  $C_{19}H_{34}$  (regarding the carboxyl group as a substituent group), abietic acid is tricyclic (parent corresponds to  $C_nH_{2n-4}$ ), which agrees with the evidence already given.

Oxidation of abietic acid with potassium permanganate gives a mixture of products, among which are two tricarboxylic acids,  $C_{11}H_{16}O_6$  (II), and  $C_{12}H_{18}O_6$  (III) [Ruzicka *et al.*, 1925, 1931]. II, on dehydrogenation with selenium, forms *m*-xylene, and III forms hemimellitene (1 : 2 : 3-trimethylbenzene) [Ruzicka *et al.*, 1931]. In both cases there is a loss of three carbon atoms, and if we assume that these were the three carboxyl groups, then two methyl groups in II and III must be in the *meta*-position. Furthermore, since II and III each contain the methyl group originally present in abietic acid (position 1), acids II and III must contain ring A of abietic acid. This suggests, therefore, that there is an angular methyl group at position 12, since it can be expected to be eliminated from this position in sulphur dehydrogenations of abietic acid (this 12-methyl group is *meta* to the 1-methyl group). Vocke (1932) showed that acid II evolves two molecules of carbon monoxide when warmed with concentrated sulphuric acid; this indicates that II contains two carboxyl groups attached to tertiary carbon atoms. These results can be explained by assuming that one carboxyl group in II is that in abietic acid, and since in both cases this carboxyl group is attached to a tertiary carbon atom, the most likely position of this group is 1 (in abietic acid). Accepting these assumptions, the oxidation of abietic acid may be formulated as follows, also assuming IV as the carbon

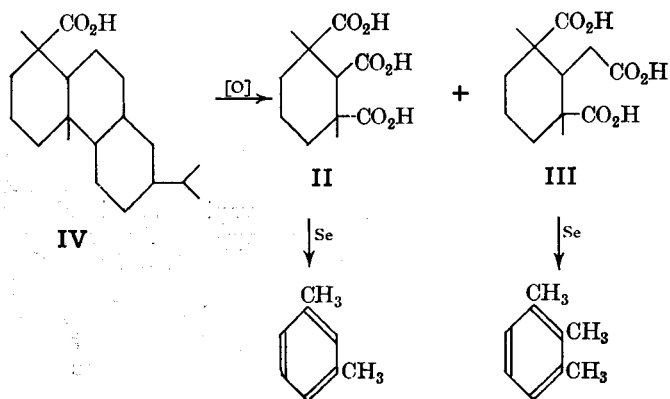

skeleton of abietic acid. Vocke subjected II to oxidative degradation, and obtained a dicarboxylic acid (V) which, on further oxidation, gave  $\alpha$ -methylglutaric acid (VI). Vocke assumed that II had the structure shown, and formulated the reactions as below, assuming structure V as the best way of explaining the results.

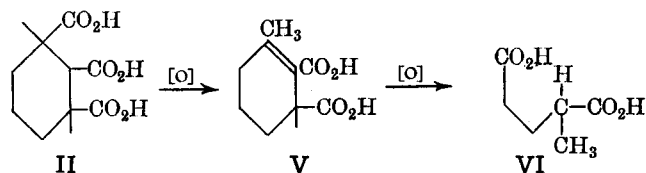

Structure V (assumed by Vocke) has been confirmed by synthesis (Rydon, 1937).

The position of the carboxyl group at position 1 in abietic acid (assumed above) has been confirmed by Ruzicka *et al.* (1922). Methyl abietate,  $C_{19}H_{29}\cdot CO_2CH_3$ , on reduction with sodium and ethanol, forms abietinol,  $C_{19}H_{29}\cdot CH_2OH$ , which, on treatment with phosphorus pentachloride, loses a molecule of water to form "methylabietin",  $C_{20}H_{30}$ . This, on distillation with sulphur, forms homoretene,  $C_{19}H_{20}$ . Homoretene contains one  $CH_2$  group more than retene, and on oxidation with alkaline potassium ferricyanide, gives phenanthrene-1 : 7-dicarboxylic acid, the identical product obtained from the oxidation of retene under similar conditions (Ruzicka *et al.*, 1932). These results can only be explained by assuming that homoretene has an ethyl group at position 1 (instead of the methyl group in retene), *i.e.*, homoretene is 1-ethyl-7-isopropylphenanthrene. This has been confirmed by synthesis (Haworth *et al.*, 1932; ethylmagnesium iodide was used instead of methylmagnesium iodide in the synthesis of retene). The formation of an ethyl group in homoretene can be explained by assuming that abietinol undergoes a Wagner-Meerwein rearrangement on dehydration (see §23d). Thus:

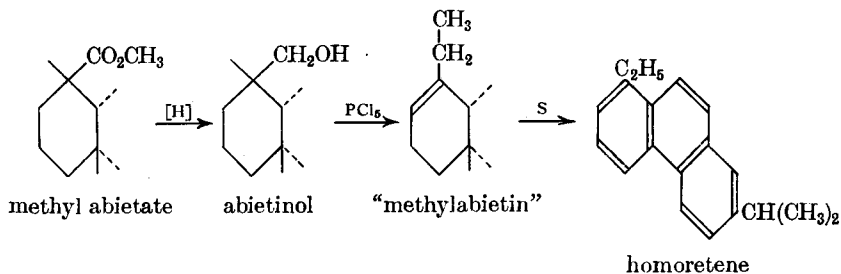

It has already been pointed out that abietic acid has two double bonds. Since abietic acid forms an adduct with maleic anhydride *at above*  $100^\circ$ , it was assumed that the two double bonds are conjugated (Ruzicka *et al.*, 1932). It was later shown, however, that levopimaric acid also forms the same adduct *at room temperature*. It thus appears that abietic acid isomerises to levopimaric acid at above  $100^\circ$ , and *then* forms the adduct. Thus this reaction cannot be accepted as evidence for conjugation in abietic acid. Nevertheless, the conjugation of the double bonds in abietic acid has been shown by means of the ultraviolet spectrum, which has not only shown the conjugation, but also indicates that the two double bonds are *not* in the same ring (Kraft, 1935; Sandermann, 1941).

Oxidation of abietic acid with potassium permanganate gives, among other products, isobutyric acid (Ruzicka *et al.*, 1925). This suggests that one double bond is in ring C and the 6 : 7- or 7 : 8-position. If the double bond is in the 6 : 7-position, then the other double bond, which is conjugated with it, must also be in the *same* ring (5 : 13 or 8 : 14); if 7 : 8, then the other double bond could be in the same ring C, but it could also

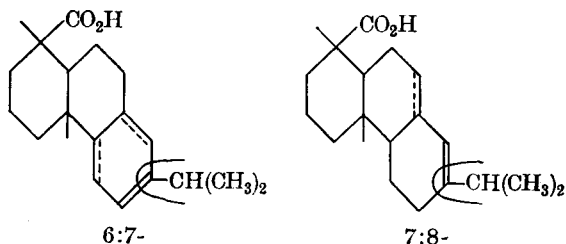

be in ring B. Since, as we have seen, the two double bonds are in different rings, their positions are *probably* 7 : 8 and 14 : 9. Further evidence for these positions is afforded by the fact that in the oxidation of abietic acid to give acids II and III (see above), *in which ring A is intact*, rings B and C are opened, and this can be readily explained only if rings B and C each have a double bond. Oxidative studies on abietic acid by Ruzicka *et al.* (1938–1941) have conclusively confirmed the positions 7 : 8 and 14 : 9.

The only other point that will be mentioned here is the conversion of abietic acid into levopimaric acid. Since the latter was originally believed to be the enantiomorph of (+)-pimaric acid, it was called (–)-pimaric acid or levopimaric acid. It is now known to be a *structural* isomer of dextropimaric acid, and so it has been suggested that levopimaric acid be called sapietic acid to avoid any confusion. The following equations show the formation of the adduct of abietic acid with maleic anhydride.

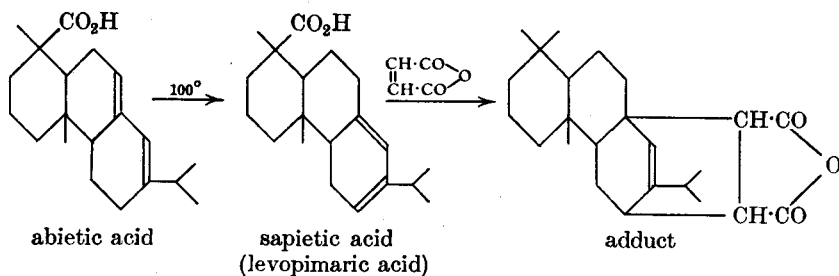

### TRITERPENES

§32. **Squalene**, C<sub>30</sub>H<sub>50</sub>, b.p. 240–242°/4 mm., has been isolated from the liver oils of sharks. Other sources are olive oil and several other vegetable oils. Squalene has also been detected in leaves. Catalytic hydrogenation (nickel) converts squalene into perhydrosqualene, C<sub>30</sub>H<sub>62</sub>; therefore squalene has six double bonds, and is acyclic. Ozonolysis of squalene gives, among other products, lævulic acid; this suggests that the following group is present in squalene:

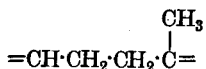

Since squalene cannot be reduced by sodium and amyl alcohol, there are no conjugated double bonds present in the molecule. Perhydrosqualene was found to be identical with the product obtained by subjecting hexahydrofarnesyl bromide to the Wurtz reaction. This led Karrer *et al.* (1931) to synthesise squalene itself from farnesyl bromide by a Wurtz reaction.



units and type of reaction are usually dependent on each other. Furthermore, other reactions which are known to occur in biological syntheses are *O*- and *N*-methylation or acylation. These may be described as *extra-skeletal processes*, and can occur at any suitable stage in the postulated biosynthesis. Another extra-skeletal process is *C*-methylation, but this is much rarer than those mentioned above.

Now let us apply these principles to the biosynthesis of terpenes. As we have seen, according to the special isoprene rule, terpenes are built up of isoprene units joined head to tail (§1). Assuming then that the isoprene unit is the basic unit, the problem is: How is it formed, and how do these units join to form the various types of terpenes? At present it is believed that the fundamental units used in the cell in syntheses are water, carbon dioxide, formic acid (as "active formate"), and acetic acid (as "active acetate"). These "active" compounds are acyl derivatives of coenzyme A (written as CoA—H in the following equation); e.g., acetoacetic acid is believed to be formed as follows:

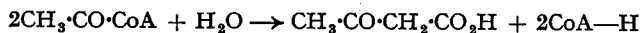

Now the biosynthesis of cholesterol (§7a. XI) from acetic acid labelled with  $^{14}\text{C}$  in the methyl group ( $C_m$ ) and in the carboxyl group ( $C_c$ ) has led to the suggestion that the carbon atoms in the isoprene unit are distributed as follows:

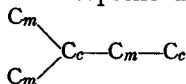

This distribution is in agreement with a scheme in which senecioic acid (3-methylbut-2-enoic acid) is formed first, and this pathway was supported by the isolation of this acid from natural sources. Further support for the formation of this carbon skeleton is given by the fact that labelled *isovaleric* acid gives rise to cholesterol in which the *isopropyl* group and the carboxyl group have been incorporated.

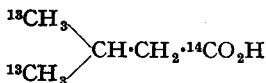

Tavormina *et al.* (1956), however, have shown that the lactone of mevalonic acid ( $\beta$ -hydroxy- $\beta$ -methyl- $\delta$ -valerolactone) is converted almost completely into cholesterol by rat liver, and is a much better precursor than senecioic acid. The following scheme has therefore been proposed for the early stages in the biosynthesis of terpenes; it is in agreement with the distribution of the carbon atoms in cholesterol (see above):

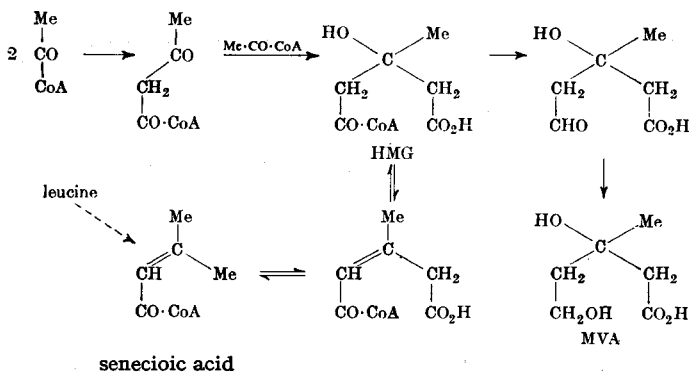

senecioic acid

Three molecules of active acetate form hydroxymethylglutaric acid, HMG (Lynen *et al.*, 1958; Rudney, 1959), and this is then converted into mevalonic

acid (MVA), possibly through the intermediate mevaldic acid (Rudney *et al.*, 1958; Lynen, 1959). Support for this sequence is afforded by the following facts. MVA has been isolated from natural sources (Wolf *et al.*, 1957), and it is also known that HMG may be formed from leucine by the route shown (Lynen *et al.*, 1958, 1959).

The biosynthesis of terpenes can be subdivided into three definite steps: (i) the formation of a biological *isopentane* unit from acetate; (ii) the condensation of this unit to form acyclic terpenes; (iii) the conversion of acyclic into cyclic terpenes.

The stages leading to MVA have been discussed above. What happens after this is uncertain. One suggestion is that MVA forms a pyrophosphate (at the primary alcoholic group), and then the carboxyl and the tertiary hydroxyl group are eliminated simultaneously to form *isopentenyl* pyrophosphate (I). This isomerises to the *isopropylidene* compound,  $\beta$ : $\beta$ -dimethylallyl pyrophosphate, which combines with (I) to form the pyrophosphate of the acyclic terpene geraniol (in the following equations P represents the pyrophosphate residue,  $P_2O_6H_3$ ):

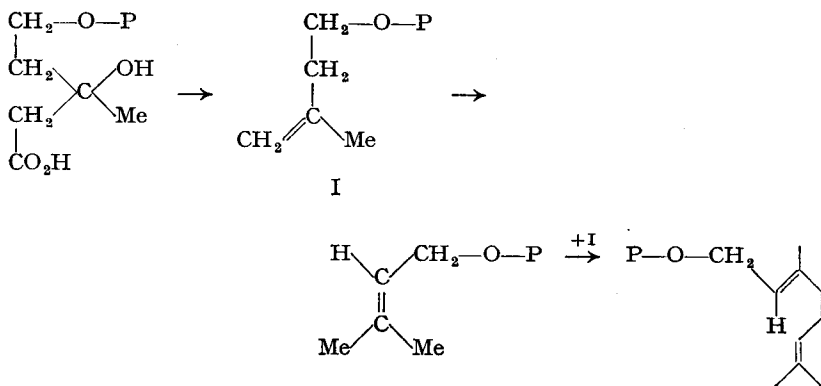

This is supported by the following work: Stanley (1958) has shown that labelled MVA ( $2\text{-}^{14}\text{C}$ -MVA) is incorporated into  $\alpha$ -pinene. Park *et al.* (1958) have observed the incorporation of labelled MVA into rubber (§33) by an enzyme system from latex, and Lynen *et al.* (1961) have also demonstrated the conversion of *isopentenyl* pyrophosphate into rubber (see also §7a. XI). Geranyl pyrophosphate has also been shown to be a precursor for farnesyl pyrophosphate, which then gives squalene.

A point of interest here is that Harley-Mason *et al.* (1961) have prepared phenylpropionic acid by the action of brosyl chloride on the sodium derivative of diethyl benzoylmalonate and treating the product with sodium hydroxide in aqueous dioxan at room temperature. The reaction has been formulated as follows:

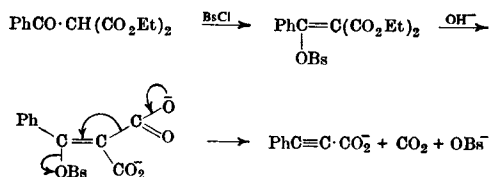

This provides one of the mildest known methods for making an acetylenic bond, and this reaction may be regarded as support for the mechanism proposed by Jones (1961) as a possible route for the biosynthesis of acetylenic bonds:

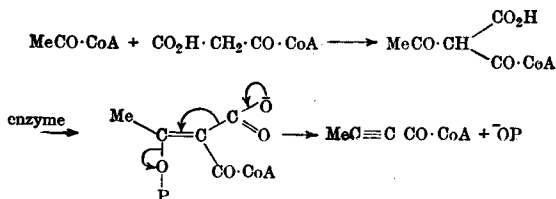

### POLYTERPENES

§33. **Rubber.** *Rubber (caoutchouc)* is obtained from latex, which is an emulsion of rubber particles in water that is obtained from the inner bark of many types of trees which grow in the tropics and sub-tropics. When the bark of the rubber tree is cut, latex slowly exudes from the cut. Addition of acetic acid coagulates the rubber, which is then separated from the liquor and either pressed into blocks or rolled into sheets, and finally dried in a current of warm air, or smoked.

Crude latex rubber contains, in addition to the actual rubber hydrocarbons (90–95 per cent.), proteins, sugars, fatty acids and resins, the amounts of these substances depending on the source. Crude rubber is soft and sticky, becoming more so as the temperature rises. It has a low tensile strength and its elasticity is exhibited only over a narrow range of temperature. When treated with solvents such as benzene, ether, light petrol, a large part of the crude rubber dissolves; the rest swells but does not dissolve. This insoluble fraction apparently contains almost all of the protein impurity. On the other hand, rubber is insoluble in acetone, methanol, etc. When unstretched, rubber is amorphous; stretching or prolonged cooling causes rubber to crystallise.

**Structure of rubber.** The destructive distillation of rubber gives isoprene as one of the main products; this led to the suggestion that rubber is a polymer of isoprene, and therefore to the molecular formula  $(\text{C}_5\text{H}_8)_n$ . This molecular formula has been confirmed by the analysis of pure rubber. Crude rubber may be purified by fractional precipitation from benzene solution by the addition of acetone. This fractional precipitation, however, produces molecules of different sizes, as shown by the determination of the molecular weights of the various fractions by osmotic pressure, viscosity and ultra-centrifuge measurements; molecular weights of the order of 300,000 have been obtained.

The halogens and the halogen acids readily add on to rubber, *e.g.*, bromine gives an addition product of formula  $(\text{C}_5\text{H}_8\text{Br}_2)_n$ , and hydrogen chloride the addition product  $(\text{C}_5\text{H}_8\text{Cl})_n$ . Pure rubber has been hydrogenated to the fully saturated hydrocarbon  $(\text{C}_5\text{H}_{10})_n$ —this is known as *hydrorubber*—by heating with hydrogen in the presence of platinum as catalyst (Pummerer *et al.*, 1922). Rubber also forms an ozonide of formula  $(\text{C}_5\text{H}_8\text{O}_3)_n$ . All these addition reactions clearly indicate that rubber is an unsaturated compound, and the formulæ of the addition products show that there is one double bond for each isoprene unit present.

Ozonolysis of rubber produces lævulaldehyde and its peroxide, lævulic acid and small amounts of carbon dioxide, formic acid and succinic acid (Harries, 1905–1912). Pummerer (1931) showed that the lævulic derivatives comprised about 90 per cent. of the products formed by the ozonolysis. This observation led to the suggestion that rubber is composed of isoprene units joined head to tail. Thus, if rubber has the following structure, the formation of the products of ozonolysis can be explained:

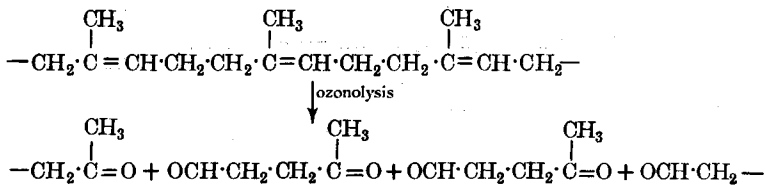

Some of the lævulaldehyde is further oxidised to lævulic and succinic acids.

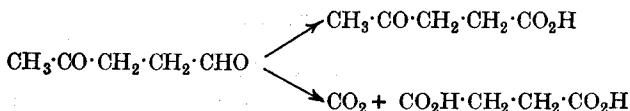

**Gutta-percha** (which is also obtained from the bark of various trees) is isomeric with rubber; their structures are the same, as shown by the methods of analysis that were used for rubber. X-ray diffraction studies (Bunn,

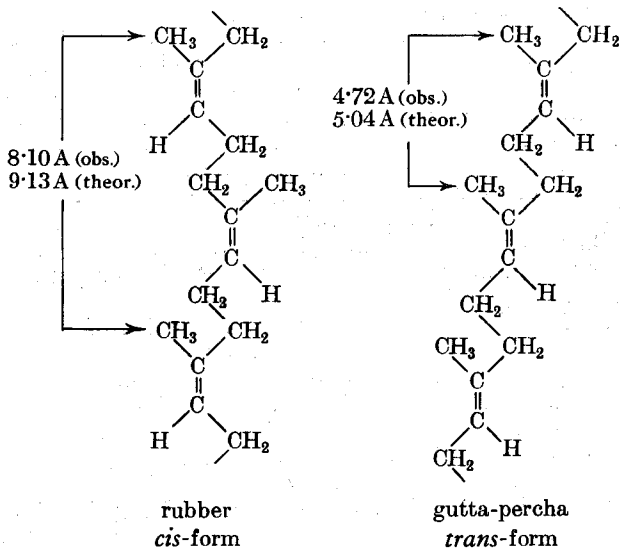

1942) have shown that rubber is composed of long chains built up of isoprene units arranged in the *cis*-form, whereas gutta-percha is the *trans*-form. Gutta-percha is hard and has a very low elasticity.

In rubber, the chain repeat unit is 8·10 Å, whereas in gutta-percha it is 4·72 Å. Both of these values are shorter than the theoretical values of the repeat distances (9·13 Å and 5·04 Å respectively) calculated from models. The reasons for these discrepancies are not clear, but for gutta-percha it has been explained by assuming that the isoprene units are not coplanar. The infra-red absorption spectrum of rubber has bands which are in keeping with the structure that has been proposed. Also, the *linear* shape of the molecule is indicated by viscosity measurements of rubber solutions. Schulz *et al.* have examined *cyclohexane* solutions of rubber by light-scattering methods, and obtained a value of 1,300,000 for the molecular weight. Their other work also supports the linear nature of the chain.

§33a. **Vulcanisation of rubber.** When crude rubber is heated with a few per cent. of sulphur, the rubber becomes *vulcanised*. Vulcanised rubber



is less sticky than crude rubber, and is not so soluble and does not swell so much in organic solvents. Furthermore, vulcanised rubber has greater tensile strength and elasticity than crude rubber.

The mechanism of vulcanisation is still not clear. Vulcanised rubber is not so unsaturated as rubber itself, the loss of one double bond corresponding approximately to each sulphur atom introduced. It therefore appears that *some* sulphur atoms enter the chain, vulcanisation thus occurring through intramolecular and intermolecular cross-links; it is the latter type of reaction that is desirable in vulcanisation. It should be noted that not all the sulphur is in a combined state; some is *free*, and this can be readily extracted.

Vulcanisation may be accelerated and carried out at lower temperatures in the presence of certain organic compounds. These compounds are consequently known as *accelerators*, and all of them contain nitrogen or sulphur, or both, *e.g.*,

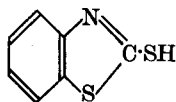
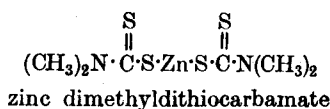
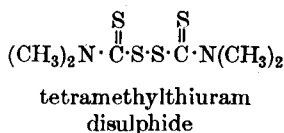
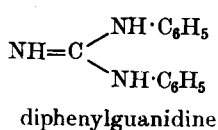

mercaptobenzothiazole

Mercaptobenzothiazole is the most widely used accelerator. Many inorganic compounds can also act as accelerators, *e.g.*, zinc oxide. Organic accelerators are promoted by these inorganic compounds, and current practice is to vulcanise rubber with, *e.g.*, mercaptobenzothiazole in the presence of zinc oxide.

The actual properties of vulcanised rubber depend on the amount of sulphur used, the best physical properties apparently being achieved by using about 3 per cent. sulphur, 5 per cent. zinc oxide and about 1 per cent. of the accelerator. When 30–50 per cent. sulphur is used, the product is *ebonite*.

The elasticity of rubber is believed to be due to the existence of rubber as long-chain molecules which are highly “kinked” in the normal state. When subjected to a stretching force, these chains “unkink”, and return to their normal condition when the force is removed.

**§33b. Synthetic rubbers.** There are many synthetic rubbers in use, each type possessing certain desirable properties. A great deal of work has been done on the synthesis of *natural* rubber, but the difficulty has been to obtain the isoprene units in the all-*cis* configuration. Wilson *et al.* (1956) have achieved this by using stereospecific catalysts.

**Buna rubbers.** Under the influence of sodium, butadiene polymerises to a substance which has been used as a rubber substitute under the name of *Buna* (see Vol. I). *Buna N* is a synthetic rubber which is produced by the copolymerisation of butadiene and vinyl cyanide. *Buna S* or *Perbunan* is a copolymer of butadiene and styrene.

**Butyl rubber.** Copolymerisation of *isobutylene* with a small amount of isoprene produces a polyisobutylene known as *Butyl rubber*.

**Neoprene.** When passed into a solution of cuprous chloride in ammonium chloride, acetylene dimerises to vinylacetylene. This dimer can

add on one molecule of hydrogen chloride to form *Chloroprene* (2-chlorobut-1:3-diene), the addition taking place in accordance with Markownikoff's rule (see also Vol. I).



Chloroprene readily polymerises to a rubber-like substance known as *Neoprene*. Actually, the nature of the polychloroprene depends on the conditions of the polymerisation.

**Silicone rubbers.** These are chemically similar to the silicone resins. The chief silicone rubber is prepared by treating the hydrolysis product of dimethyldichlorosilane,  $(\text{CH}_3)_2\text{SiCl}_2$ , with various compounds capable of increasing the molecular weight without the formation of cross-links, *i.e.*, they produce long-chain molecules.

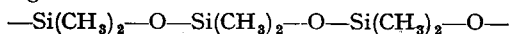

Silicone rubbers have very high electrical insulating properties, and do not deteriorate on exposure to light and air, and are resistant to the action of acids and alkalis.

#### READING REFERENCES

- The Terpenes*, Cambridge University Press (2nd ed.). Sir John Simonsen and Owen. Vol. I (1947); Vol. II (1949). Sir John Simonsen and Barton. Vol. III (1952). Sir John Simonsen and Ross. Vol. IV. (1957); Vol. V. (1957).
- Gilman (Ed.), *Advanced Organic Chemistry*, Wiley (1953). Vol. IV, Ch. 7. The Terpenes.
- Rodd (Ed.), *Chemistry of the Carbon Compounds*, Elsevier. (i) Vol. IIA (1953). Ch. 11. Rubber and Rubber-like Compounds (p. 407). (ii) Vol. IIB (1953). Chh. 12-16. Terpenoids.
- Mayo, Vol. I. *Mono- and Sesquiterpenoids*. Vol. II. *The Higher Terpenoids*. Interscience (1959).
- Pinder, *The Chemistry of the Terpenes*, Chapman and Hall (1960).
- Ruzicka, History of the Isoprene Rule, *Proc. Chem. Soc.*, 1959, 341.
- Ginsburg (Ed.), *Non-Benzenoid Aromatic Compounds*, Interscience (1959). Chh. V, VI. Azulenes.
- Streitwieser, Solvolytic Displacement Reactions at Saturated Carbon Atoms, *Chem. Reviews*, 1956, 56, p. 698 (Wagner-Meerwein Rearrangements).
- Barton, The Chemistry of the Diterpenoids, *Quart. Reviews (Chem. Soc.)*, 1949, 3, 36.
- Gascoigne and Simes, The Tetracyclic Terpenes, *Quart. Reviews (Chem. Soc.)*, 1955, 9, 328.
- Barton and Mayo, Recent Advances in Sesquiterpenoid Chemistry, *Quart. Reviews (Chem. Soc.)*, 1957, 11, 189.
- Halsall and Theobald, Recent Aspects of Sesquiterpenoid Chemistry, *Quart. Reviews (Chem. Soc.)*, 1962, 16, 101.
- Progress in Organic Chemistry*, Butterworths. Vol. 5 (1961). Ch. 4. The Chemistry of the Higher Terpenoids.
- Ciba Foundation Symposium on the Biosynthesis of Terpenes and Sterols, Churchill (1959).
- Sir Robert Robinson, *The Structural Relations of Natural Products*, Oxford Press (1955).
- Downes, *The Chemistry of Living Cells*, Longmans, Green (2nd ed., 1963).
- Birch, Some Pathways in Biosynthesis, *Proc. Chem. Soc.*, 1962, 3.
- Gee, Some Thermodynamic Properties of High Polymers and their Molecular Interpretation, *Quart. Reviews (Chem. Soc.)*, 1947, 1, 265.
- Hardy and Megson, The Chemistry of Silicon Polymers, *Quart. Reviews (Chem. Soc.)*, 1948, 2, 25.
- Flory, *Principles of Polymer Chemistry*, Cornell University Press (1953).

CHAPTER IX  
CAROTENOIDS

**§1. Introduction.** The carotenoids are yellow or orange pigments which are widely distributed in plants and animals. Chlorophyll is always associated with the carotenoids carotene and lutein; the carotenoids act as photosensitisers in conjunction with chlorophyll. When chlorophyll is absent, *e.g.*, in fungi, then the carotenoids are mainly responsible for colour. Carotenoids are also known as lipochromes or chromolipids because they are fat-soluble pigments. They give a deep blue colour with concentrated sulphuric acid and with a chloroform solution of antimony trichloride (the Carr-Price reaction); this Carr-Price reaction is the basis of one method of the quantitative estimation of carotenoids. Some carotenoids are hydrocarbons; these are known as the *carotenes*. Other carotenoids are oxygenated derivatives of the carotenes; these are the *xanthophylls*. There are also acids, the *carotenoid acids*, and esters, the *xanthophyll esters*.

Chemically, the carotenoids are polyenes, and almost all the carotenoid hydrocarbons have the molecular formula  $C_{40}H_{56}$ . Also, since the carbon skeleton of these compounds has a polyisoprene structure, they may be regarded as tetraterpenes (*cf.* §1. VIII).

In most of the carotenoids, the central portion of the molecule is composed of a long conjugated chain comprised of four isoprene units, the centre two of which are joined tail to tail. The ends of the chain may be two open-chain structures, or one open-chain structure and one ring, or two rings. The colour of the carotenoids is attributed to the extended conjugation of the central chain (see Vol. I). X-ray analysis has shown that in the majority of natural carotenoids, the double bonds are in the *trans*-position; a few natural carotenoids are *cis*-. Thus, if we represent the ends of the chain by R (where R may be an open-chain structure or a ring system), *trans*-carotenes may be written:

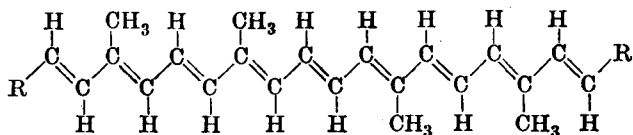

If we use the conventional formulæ of terpenes (§4. VIII), the above formula will be the following (the reader should write out in this way the various formulæ given in the text; see §6 for an example):

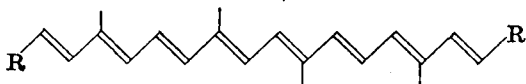

**§2. Carotenes.** Carotene was first isolated by Wackenroder (1831) from carrots (this was the origin of the name *carotin*, which was later changed to *carotene*). The molecular formula of carotene, however, was not determined until 1907, when Willstätter showed it was  $C_{40}H_{56}$ . Carotene was shown to be unsaturated, and when treated with a *small* amount of iodine, it forms a crystalline di-iodide,  $C_{40}H_{56}I_2$ . Kuhn (1929) separated this di-iodide into two fractions by means of fractional crystallisation. Treatment of each fraction with thiosulphate regenerated the corresponding carotenes, which were designated  $\alpha$ - and  $\beta$ -carotene. Kuhn *et al.* (1933) then found that

chromatography gives a much better separation of the carotenes themselves, and in this way isolated a third isomer, which he designated  $\gamma$ -carotene.

$\alpha$ -Carotene, m.p. 187–187.5°; optically active (dextrorotatory).

$\beta$ -Carotene, m.p. 184.5°; optically inactive.

$\gamma$ -Carotene, m.p. 176.5°; optically inactive.

It appears that all three carotenes occur together in nature, but their relative proportions vary with the source, *e.g.*, carrots contain 15 per cent.  $\alpha$ , 85 per cent.  $\beta$  and 0.1 per cent.  $\gamma$ . Carotenes are obtained commercially by chromatography, two of the best sources being carrots and alfalfa.

Biosynthetic studies of the carotenes have been carried out, and the pathways are those for the terpenes (§32a. VIII). Thus Braithwaite *et al.* (1957) and Grob (1957) have shown that labelled mevalonic acid is incorporated into  $\beta$ -carotene. Scheuer *et al.* (1959) have also shown that this acid is incorporated into lycopene. Furthermore, Modi *et al.* (1961) have isolated mevalonic acid from carrots.

**§3.  $\beta$ -Carotene,  $C_{40}H_{56}$ .** When catalytically hydrogenated (platinum),  $\beta$ -carotene forms perhydro- $\beta$ -carotene,  $C_{40}H_{78}$ . Thus  $\beta$ -carotene contains eleven double bonds, and since the formula of perhydro- $\beta$ -carotene corresponds to the general formula  $C_nH_{2n-2}$ , it follows that the compound contains two rings.

When exposed to air,  $\beta$ -carotene develops the odour of violets. Since this odour is characteristic of  $\beta$ -ionone, it was thought that this residue is present in  $\beta$ -carotene (see §6. VIII). This was confirmed by the fact that the oxidation of a benzene solution of  $\beta$ -carotene with cold aqueous potassium permanganate gives  $\beta$ -ionone. Now  $\beta$ -ionone, I, on ozonolysis, gives, among other things, geronic acid, II (Karrer *et al.*, 1929).

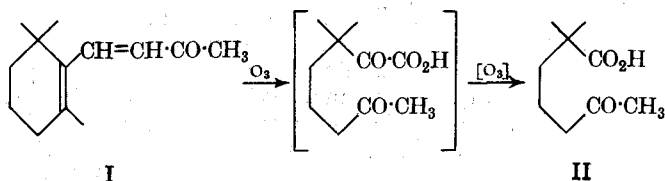

$\beta$ -Carotene, on ozonolysis, gives geronic acid in an amount that corresponds to the presence of two  $\beta$ -ionone residues (Karrer *et al.*, 1930). Thus a tentative structure for  $\beta$ -carotene is:

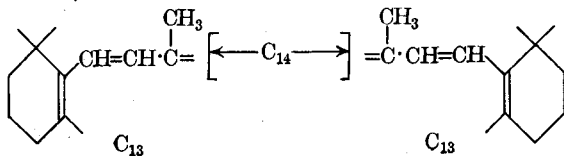

Since the colour of  $\beta$ -carotene is due to extended conjugation (§1), the  $C_{14}$  portion of the molecule will be conjugated. The presence of conjugation in this central portion is confirmed by the fact that  $\beta$ -carotene forms an adduct with five molecules of maleic anhydride (Nakamiya, 1936).

Geronic acid, on oxidation with cold aqueous potassium permanganate, forms a mixture of acetic acid,  $\alpha$ : $\alpha$ -dimethylglutaric, III,  $\alpha$ : $\alpha$ -dimethylsuccinic, IV, and dimethylmalonic acids, V.

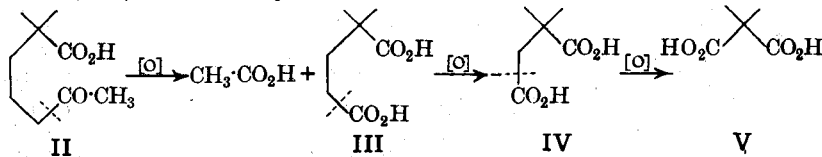

Oxidation of  $\beta$ -carotene in benzene solution with cold aqueous permanganate gives a mixture of  $\beta$ -ionone, III, IV, V, and acetic acid, the amount of acetic acid being more than can be accounted for by the presence of two  $\beta$ -ionone residues. Thus there must be some methyl side-chains in the central  $C_{14}$  portion of the molecule. Since it is essential to know the exact number of these methyl side-chains, this led to the development of the **Kuhn-Roth methyl side-chain determination** (1931). The first method used was to oxidise the carotenoid with alkaline permanganate, but later chromic acid (chromium trioxide in sulphuric acid) was found to be more reliable, the methyl group in the fragment  $-C(CH_3)=$  being always oxidised to acetic acid. It was found that alkaline permanganate only oxidises the fragment  $=C(CH_3)-CH=$  to acetic acid, and fragments such as  $=C(CH_3)-CH_2-$  are incompletely oxidised to acetic acid, or not attacked at all (Karrer *et al.*, 1930). Since a molecule ending in an isopropylidene group also gives acetic acid on oxidation with chromic acid, this end group is determined by ozonolysis, the acetone so formed being estimated volumetrically. Application of the Kuhn-Roth methyl side-chain determination to  $\beta$ -carotene gave four molecules of acetic acid, thus indicating that there are four  $-C(CH_3)=$  groups in the *chain*. The positions of two of these have already been tentatively placed in the two end  $\beta$ -ionone residues (see tentative structure above), and so the problem is now to find the positions of the remaining two. This was done as follows. Distillation of carotenoids under normal conditions brings about decomposition with the formation of aromatic compounds. Thus the distillation of  $\beta$ -carotene produces toluene, *m*-xylene and 2:6-dimethylnaphthalene (Kuhn *et al.*, 1933). The formation of these compounds may be explained by the cyclisation of fragments of the polyene chain, without the  $\beta$ -ionone rings being involved. The following types of chain fragments would give the desired aromatic products:

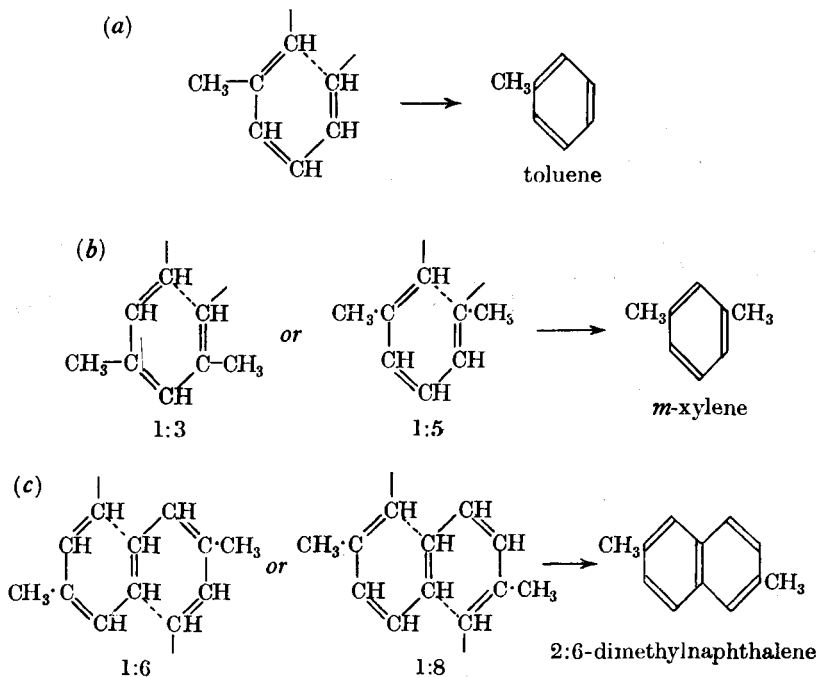

The following *symmetrical* structure for  $\beta$ -carotene would satisfy the requirements of (a), (b) and (c); the tail to tail union of the two isoprene units at the centre should be noted.

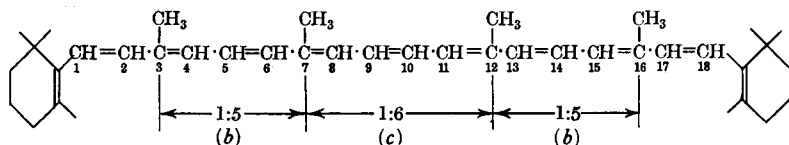

This symmetrical formula for  $\beta$ -carotene has been confirmed by the following oxidation experiments (Kuhn *et al.*, 1932-1935). When  $\beta$ -carotene is oxidised *rapidly* with potassium dichromate, dihydroxy- $\beta$ -carotene, VI, is obtained and this, on oxidation with lead tetra-acetate, gives semi- $\beta$ -carotenone, VII, a diketone. Since both VI and VII contain the *same* number of carbon atoms as  $\beta$ -carotene, it follows that the *double bond in one of the  $\beta$ -ionone rings* has been oxidised; otherwise there would have been chain scission had the chain been oxidised. Oxidation of semi- $\beta$ -carotenone with chromium trioxide produces  $\beta$ -carotenone, VIII, a tetraketone which also has the same number of carbon atoms as  $\beta$ -carotene. Thus, in this compound, the *other  $\beta$ -ionone ring is opened*. Now only *one* dihydroxy- $\beta$ -carotene and *one* semi- $\beta$ -carotenone are obtained, and this can be explained only by assuming a symmetrical structure for  $\beta$ -carotene. Thus the oxidations may be formulated:

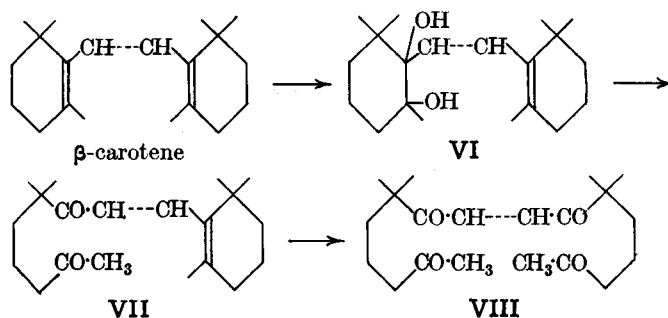

This structure for  $\beta$ -carotene has been confirmed by synthesis, *e.g.*, that of Karrer *et al.* (1950). The acetylenic carbinol IX is treated with ethylmagnesium bromide and the product is treated as shown on opposite page.

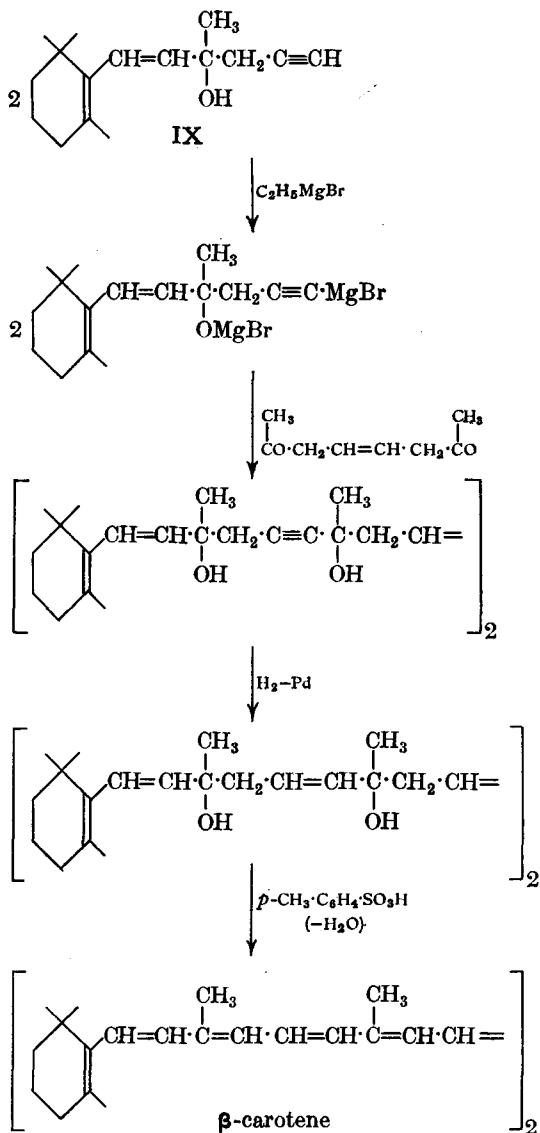

IX has been prepared by Isler (1949) by treating  $\beta$ -ionone with propargyl bromide in the presence of zinc (*cf.* the Reformatsky reaction):

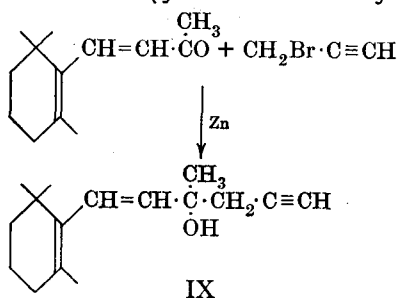

The most convenient way of preparing the diketone (oct-4-ene-2 : 7-dione) starts with but-1-yn-3-ol (Inhoffen *et al.*, 1951):

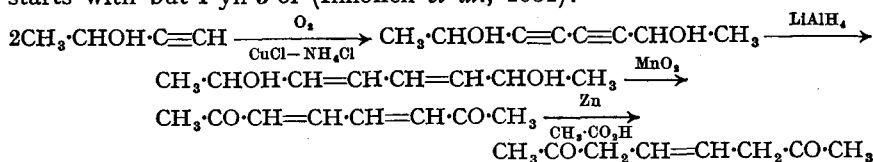

An important point to note in this synthesis is that lithium aluminium hydride will reduce a triple bond to a double bond when the former is adjacent to a propargylic hydroxyl group, *i.e.*,

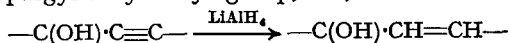

It is worth while at this point to consider the general aspects of carotene syntheses. All syntheses have used the union of a bifunctional unit, which forms the central part of the carotene molecule, with two molecules (identical as for, *e.g.*,  $\beta$ -carotene, or not identical as for, *e.g.*,  $\alpha$ -carotene). The various methods have been divided into four groups according to the carbon content of the three units used in the synthesis:  $\text{C}_{19} + \text{C}_2 + \text{C}_{19}$ ;  $\text{C}_{16} + \text{C}_8 + \text{C}_{16}$ ;  $\text{C}_{14} + \text{C}_{12} + \text{C}_{14}$ ;  $\text{C}_{10} + \text{C}_{20} + \text{C}_{10}$ . The second group has been used in the above synthesis of  $\beta$ -carotene.

An example of the synthesis of  $\beta$ -carotene by the third is that of Isler *et al.* (1957) [ $\text{R}_\beta = \beta$ -ionine ring]:

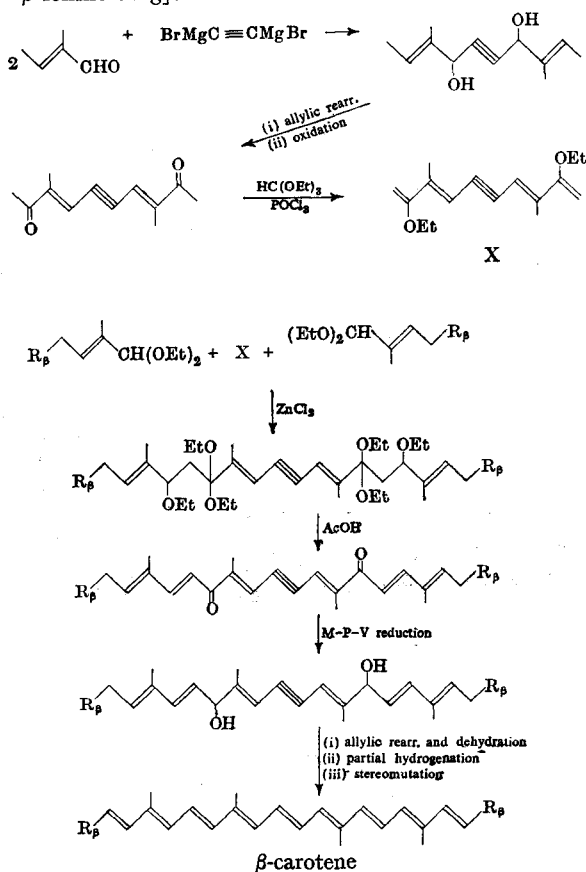



An example of the fourth group makes use of the Wittig reaction (see crocetin, §9 for an illustration of this method).

§4.  **$\alpha$ -Carotene,  $C_{40}H_{56}$ .** This is isomeric with  $\beta$ -carotene, and oxidation experiments on  $\alpha$ -carotene have led to results similar to those obtained for  $\beta$ -carotene, except that *isogeronic acid* is obtained as well as *geronic acid*. Since *isogeronic acid* is an oxidation product of  $\alpha$ -ionone, the conclusion is that  $\alpha$ -carotene contains one  $\beta$ -ionone ring and one  $\alpha$ -ionone ring (§6. VIII) [Karrer *et al.*, 1933].

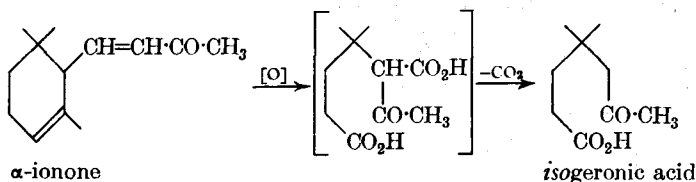

Thus the structure of  $\alpha$ -carotene is:

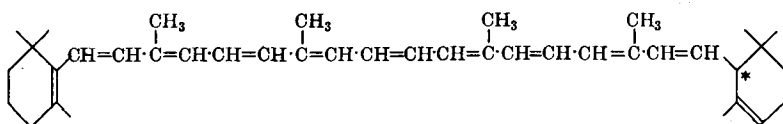

As we have seen,  $\alpha$ -carotene is optically active (§1), and this is due to the presence of the asymmetric carbon atom (\*) in the  $\alpha$ -ionone ring. The structure given for  $\alpha$ -carotene has been confirmed by synthesis (Karrer *et al.*, 1950). The method is the same as that described for  $\beta$ -carotene, except that *one* molecule of the acetylenic alcohol (structure IX, §3) is used together with one molecule of the corresponding  $\alpha$ -ionone derivative:

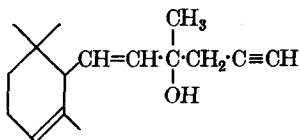

It is interesting to note that  $\alpha$ -carotene has been converted into the  $\beta$ -isomer by heating the  $\alpha$ -compound with ethanolic sodium ethoxide and benzene at 100–110° for some time (Karrer *et al.*, 1947); this is an example of *three carbon prototropy*.

§5. **Lycopene,  $C_{40}H_{56}$ ,** m.p. 175°, is a carotenoid that is the tomato pigment. Since the structure of  $\gamma$ -carotene depends on that of lycopene, the latter will be discussed here, and the former in the next section.

On catalytic hydrogenation (platinum), lycopene is converted into perhydrolycopene,  $C_{40}H_{82}$ . Therefore lycopene has thirteen double bonds, and is an acyclic compound (Karrer *et al.*, 1928). Ozonolysis of lycopene gives, among other products, acetone and laevulic acid; this suggests that lycopene contains the terminal residue:

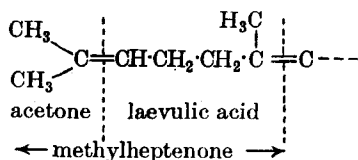

This is supported by the fact that controlled oxidation of lycopene with chromic acid produces 6-methylhept-5-en-2-one (*cf.* §5. VIII). Quantitative oxidation experiments (ozonolysis) indicate that this grouping occurs at each end of the molecule (Karrer *et al.*, 1929, 1931). Also, the quantitative oxidation of lycopene with chromic acid gives six molecules of acetic acid per molecule of lycopene, thereby suggesting that there are six  $-\text{C}(\text{CH}_3)=$  groups present in the chain (*cf.* §3). Controlled oxidation of lycopene with chromic acid gives one molecule of methylheptenone and one molecule of lycopenal,  $\text{C}_{32}\text{H}_{42}\text{O}$ , and the latter may be further oxidised with chromic acid to another molecule of methylheptenone and one molecule of a dialdehyde,  $\text{C}_{24}\text{H}_{28}\text{O}_2$  (Kuhn *et al.*, 1932). Thus this dialdehyde constitutes the central part of the chain, and the two molecules of methylheptenone must have been produced by the oxidation of each end of the chain in lycopene. The dialdehyde may be converted into the corresponding dioxime, and this, on dehydration to the dicyanide, followed by hydrolysis, forms the dicarboxylic acid  $\text{C}_{24}\text{H}_{28}\text{O}_4$ , which is identical with norbixin (§9). Thus the dialdehyde must be bixindialdehyde, and so it may be inferred that the structure of lycopene is the following symmetrical one, since it accounts for all the above facts.

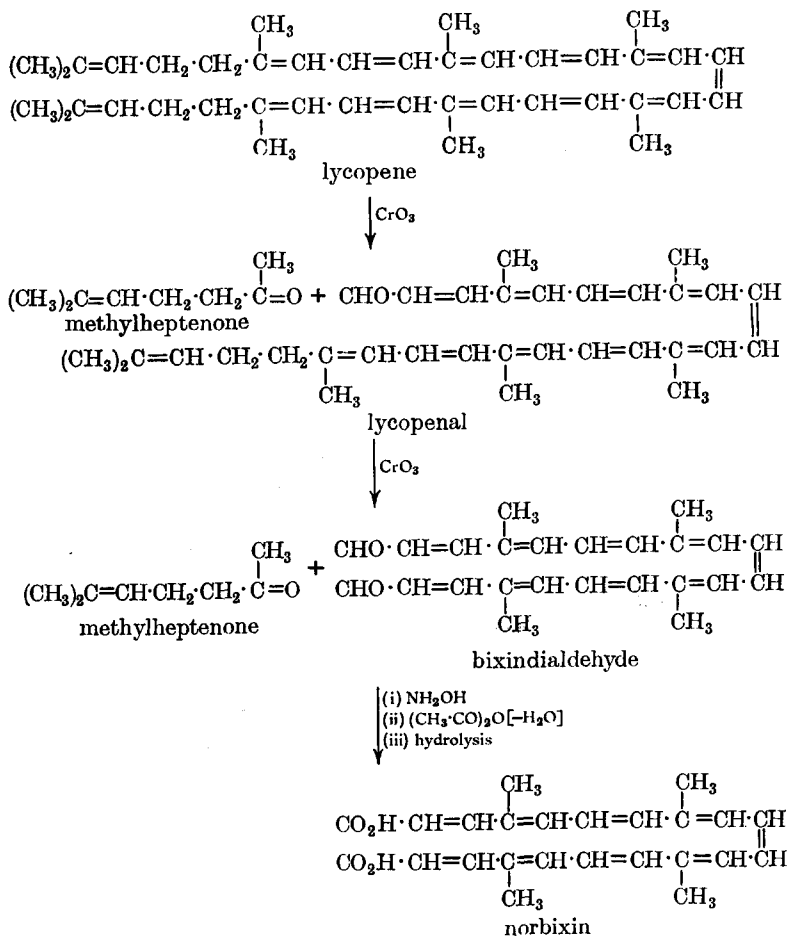

The structure assigned to lycopene has been confirmed by synthesis (Karrer *et al.*, 1950). Instead of the acetylenic carbinol IX in §3, two molecules of the following compound were used.

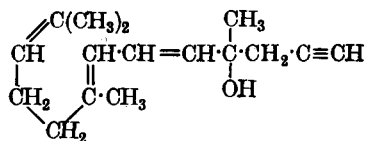

§6.  $\gamma$ -Carotene,  $\text{C}_{40}\text{H}_{56}$ . Catalytic hydrogenation converts  $\gamma$ -carotene into perhydro- $\gamma$ -carotene,  $\text{C}_{40}\text{H}_{80}$ . Thus there are twelve double bonds present, and the compound contains one ring. Ozonolysis of  $\gamma$ -carotene gives, among other products, acetone, lævulic acid and geronic acid. The formation of acetone and lævulic acid indicates the structural relationship of  $\gamma$ -carotene to lycopene, and the formation of geronic acid indicates the presence of a  $\beta$ -ionone ring (Kuhn *et al.*, 1933). On this evidence, and also on the fact that the growth-promoting response in rats was found to be half that of  $\beta$ -carotene, Kuhn suggested that  $\gamma$ -carotene consists of half a molecule of  $\beta$ -carotene joined to half a molecule of lycopene; thus:

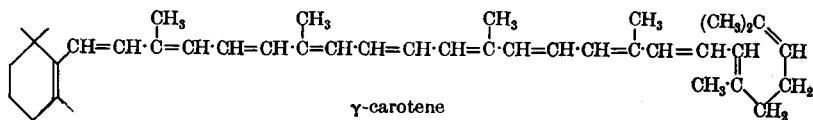

This structure for  $\gamma$ -carotene is supported by the fact that the absorption maximum of  $\gamma$ -carotene in the visible region lies between that of  $\beta$ -carotene and that of lycopene. Final proof for this structure has been obtained by the synthesis of  $\gamma$ -carotene (Karrer *et al.*, 1953); the following reactions are written with the conventional formulæ (see §1):

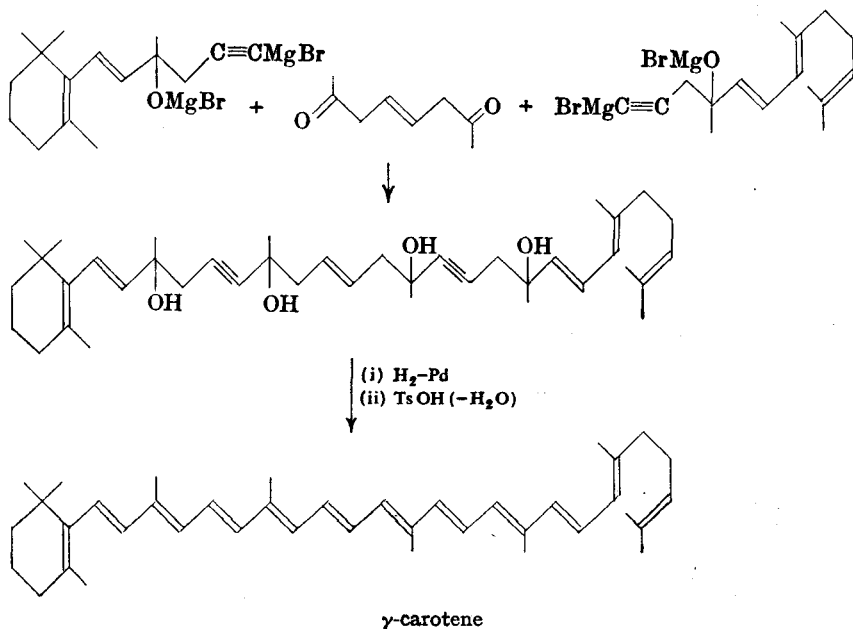

A  $\delta$ -carotene has also been isolated, and this has been shown to be the  $\alpha$ -ionone analogue of  $\gamma$ -carotene (Kargel *et al.*, 1960).

§7. **Vitamin A**,  $C_{20}H_{30}O$ . Vitamin A is also known as **Axerophthol**, and is also usually referred to as vitamin  $A_1$  since a second compound, known as vitamin  $A_2$ , has been isolated.

Vitamin  $A_1$  influences growth in animals, and also apparently increases resistance to disease. Night blindness is due to vitamin  $A_1$  deficiency in the human diet, and a prolonged deficiency leads to xerophthalmia (hardening of the cornea, etc.). Vitamin  $A_1$  occurs free and as esters in fats, in fish livers and in blood. It was originally isolated as a viscous yellow oil, but later it was obtained as a crystalline solid, m.p.  $63-64^\circ$  (Baxter *et al.*, 1940). Vitamin  $A_1$  is estimated by the blue colour reaction it gives with a solution of antimony trichloride in chloroform (the Carr-Price reaction; *cf.* §1); it is also estimated by light absorption (vitamin  $A_1$  has a maximum at  $328 m\mu$ ).

Carotenoids are converted into vitamin  $A_1$  in the intestinal mucosa, and feeding experiments showed that the potency of  $\alpha$ - and  $\gamma$ -carotenes is half that of  $\beta$ -carotene. This provitamin nature of  $\beta$ -carotene led to the suggestion that vitamin  $A_1$  is half the molecule of  $\beta$ -carotene.

On catalytic hydrogenation, vitamin  $A_1$  is converted into perhydrovitamin  $A_1$ ,  $C_{20}H_{40}O$ ; thus vitamin  $A_1$  contains five double bonds. Since vitamin  $A_1$  forms an ester with *p*-nitrobenzoic acid (this ester is not crystallisable), it follows that vitamin  $A_1$  contains a hydroxyl group. Thus the parent hydrocarbon of vitamin  $A_1$  is  $C_{20}H_{40}$ , and consequently the molecule contains one ring. Ozonolysis of vitamin  $A_1$  produces one molecule of geronic acid (§3) per molecule of vitamin  $A_1$ , and so there must be one  $\beta$ -ionone nucleus present (Karrer, 1931, 1932). Oxidation of vitamin  $A_1$  with permanganate produces acetic acid; this suggests that there are some  $-C(CH_3)=$  groups in the chain. All of the foregoing facts are in keeping with the suggestion that vitamin  $A_1$  is half the  $\beta$ -carotene structure. When heated with an ethanolic solution of hydrogen chloride, vitamin  $A_1$  is converted into some compound (II) which, on dehydrogenation with selenium forms 1:6-dimethylnaphthalene, III (Heilbron *et al.*, 1932). Heilbron assumed I as the structure of vitamin  $A_1$ , and explained the course of the reaction as follows:

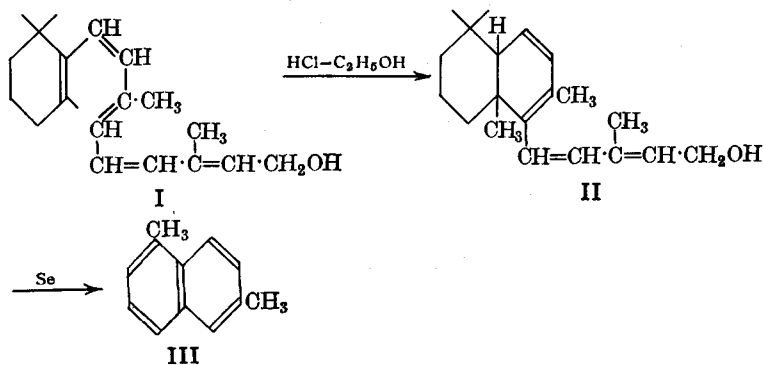

Perhydrovitamin  $A_1$  has been synthesised from  $\beta$ -ionone (Karrer, 1933), and was shown to be identical with the compound obtained by reducing vitamin  $A_1$ ; thus there is evidence to support the structure assigned to vitamin  $A_1$ . Final proof of structure must rest with a synthesis of vitamin  $A_1$  itself, and this has now been accomplished by several groups of workers.

The following synthesis is that of Isler *et al.* (1947). This starts with methyl vinyl ketone to produce compound IV, one stage of the reactions involving

*Preparation of IV.*

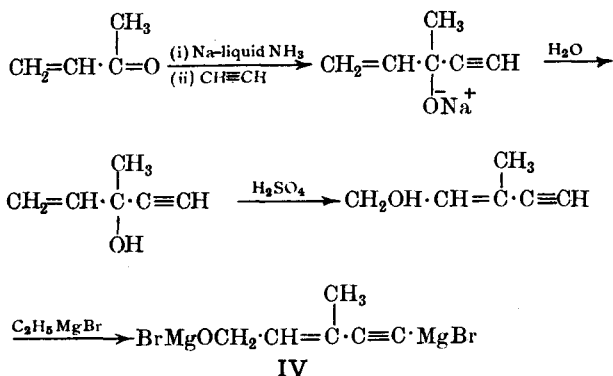

*Preparation of V.*

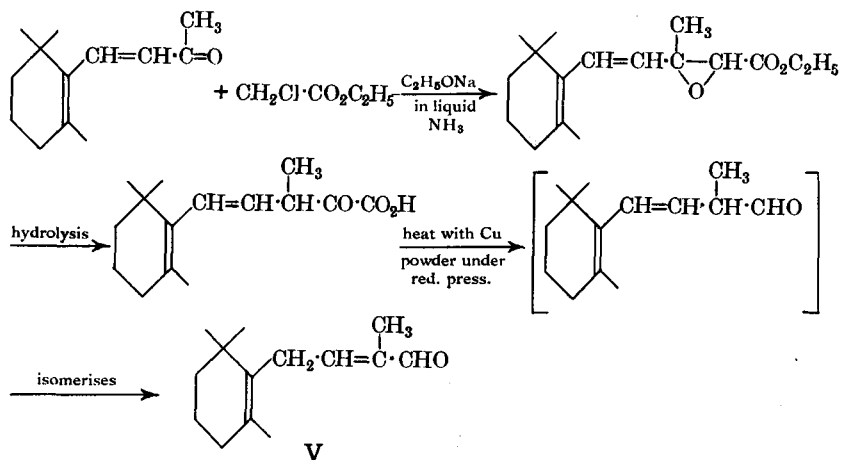

an allylic rearrangement (*cf.* §8. VIII). Compound V is prepared from  $\beta$ -ionone by means of the Darzens glycidic ester reaction (see also Vol. I). The following chart shows the steps of the synthesis, and it should be noted that another allylic rearrangement is involved in one of the later steps.

Combination of IV and V, etc.

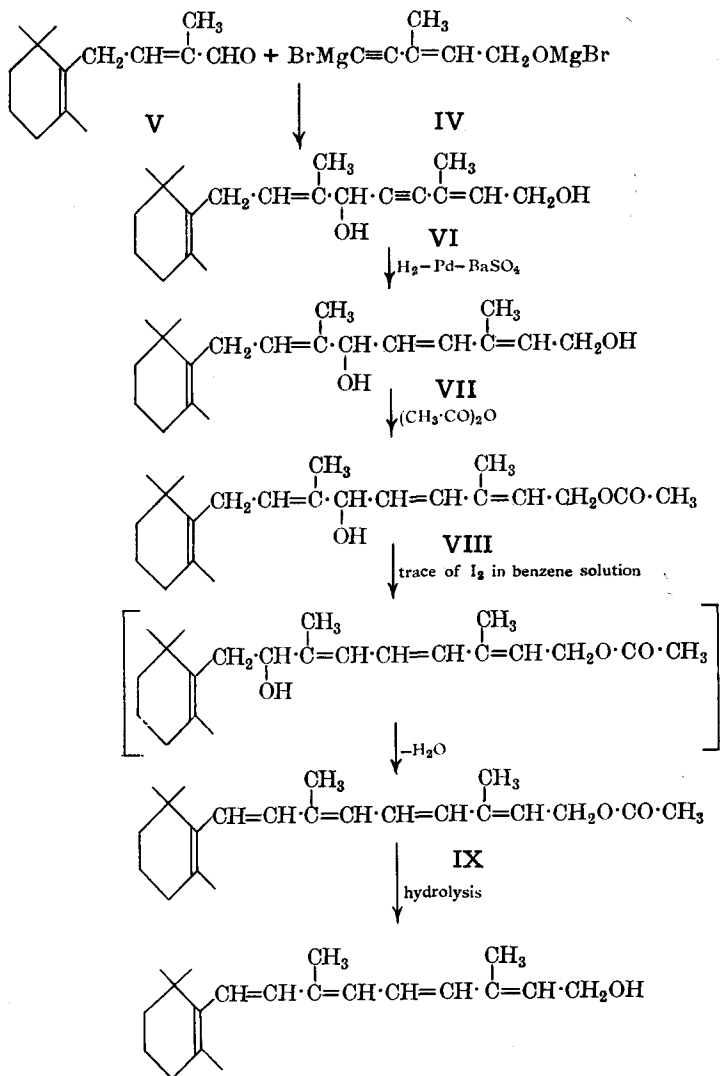

In the hydrogenation of VI to VII, barium sulphate is used to act as a poison to the catalyst to prevent hydrogenation of the *double* bonds. Partial acetylation of VII (primary alcoholic groups are more readily acetylated than secondary) protects the terminal group from an allylic rearrangement in the conversion of VIII to IX.

The crude vitamin  $A_1$  obtained in the above synthesis was purified *via* its ester with anthraquinone-2-carboxylic acid, and was thereby obtained in a crystalline form which was shown to be identical with natural vitamin  $A_1$ .

Lindlar (1952) has shown that triple bonds may be partially hydrogenated in the presence of a Pd—CaCO<sub>3</sub> catalyst that has been partially inactivated by treatment with lead acetate; better results are obtained by the addition of quinoline. Thus the hydrogenation of VI gives VII in 86 per cent. yield when the Lindlar catalyst is used.

Another method of synthesising vitamin A<sub>1</sub> is due to van Dorp *et al.* (1946) who prepared vitamin A<sub>1</sub> acid (X), which was then reduced by means of lithium aluminium hydride to vitamin A<sub>1</sub> by Tishler (1949); β-ionone and methyl γ-bromocrotonate are the starting materials.

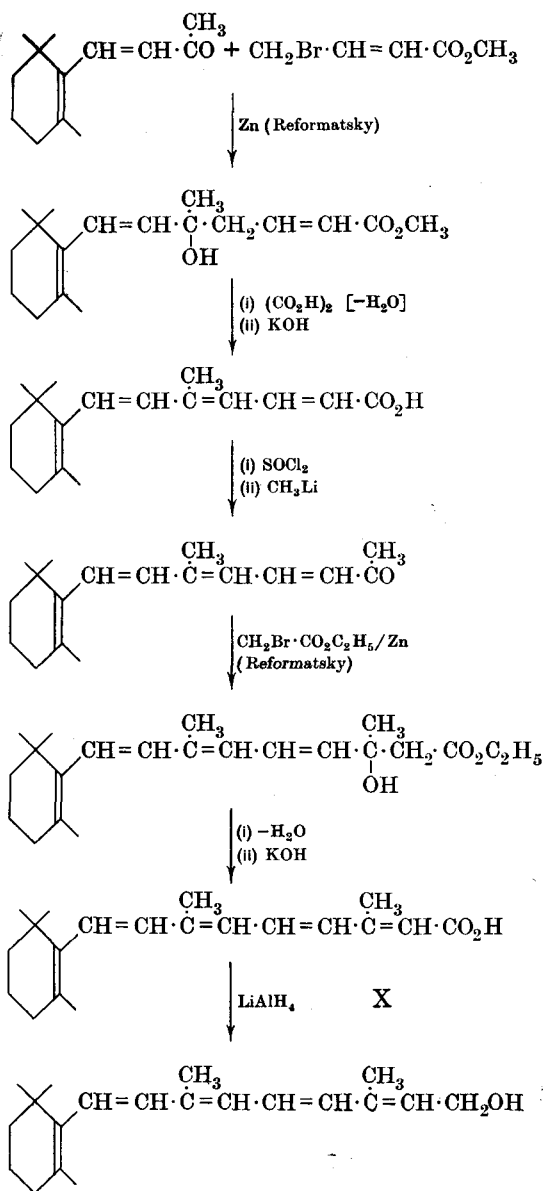

Attenburrow *et al.* (1952) have also synthesised vitamin A<sub>1</sub> starting from 2-methylcyclohexanone.

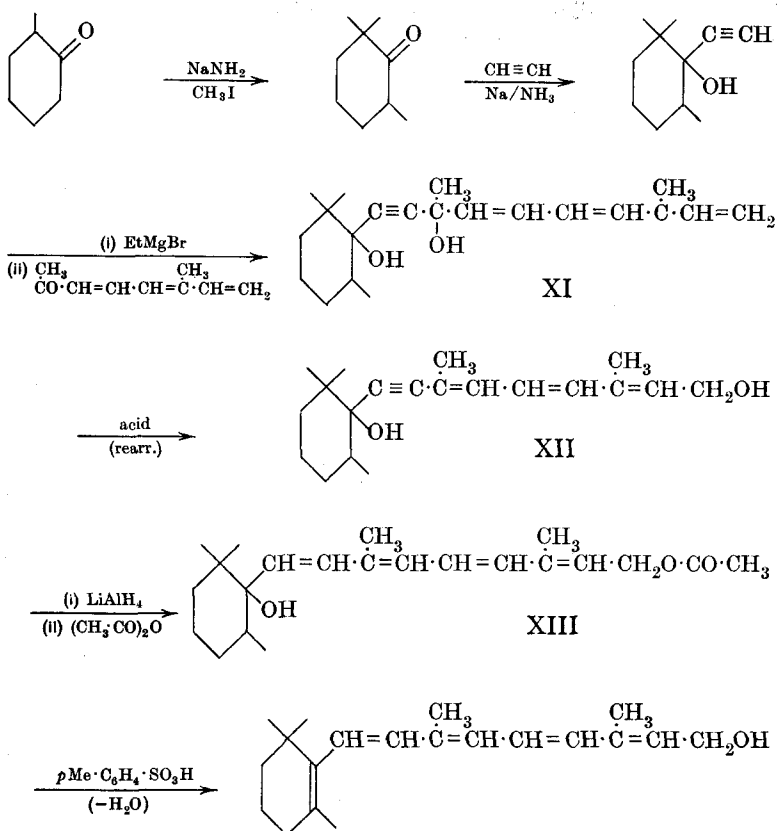

Acid causes rearrangement of XI to XII in which all multiple bonds are in complete conjugation, and the reduction of XII to XIII by lithium aluminium hydride is possible because of the presence of the propargylic hydroxyl grouping (§3).

Synthetic vitamin A<sub>1</sub> is now a commercial product.

Two biologically active geometrical isomers of Vitamin A<sub>1</sub> (all-*trans*) have also been isolated: **neovitamin a** from rat liver (Robeson *et al.*, 1947) and **neovitamin b** from the eye (Oroshnik *et al.*, 1956). Vitamin A<sub>1</sub> is the most active form in curing "vitamin A" deficiency.

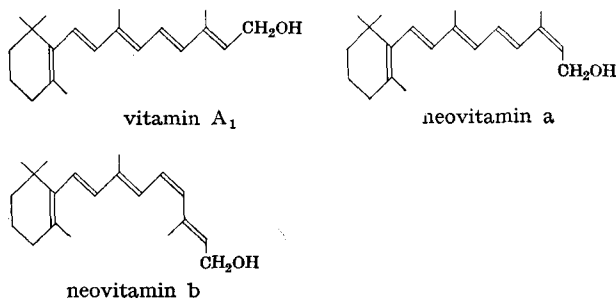



**Vitamin A<sub>2</sub>.** A second vitamin A, vitamin A<sub>2</sub>, has been isolated from natural sources, and has been synthesised by Jones *et al.* (1951, 1952); it is dehydrovitamin A<sub>1</sub>.

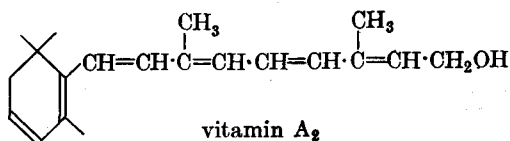

Jones *et al.* (1955) have also introduced a method for converting vitamin A<sub>1</sub> into vitamin A<sub>2</sub>. Vitamin A<sub>1</sub> may be oxidised to vitamin A<sub>1</sub> aldehyde (**retinene<sub>1</sub>**) by means of manganese dioxide in acetone solution (Morton *et al.*, 1948), and then treated as follows:

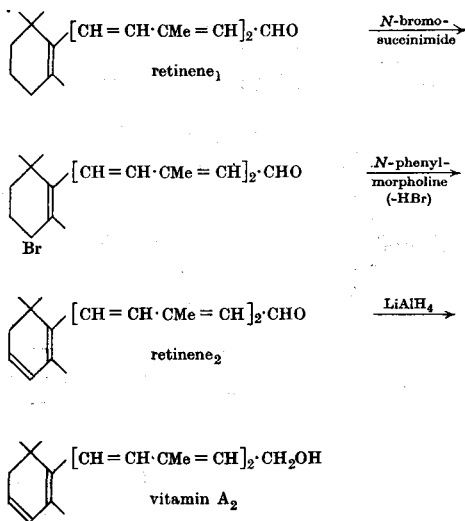

**§8. Xanthophylls.** The xanthophylls occur naturally, and all have the same carbon skeletons as the carotenes or lycopene (except flavoxanthin).

**Cryptoxanthin**, C<sub>40</sub>H<sub>56</sub>O, m.p. 169°, is monohydroxy-β-carotene; it has provitamin-A activity.

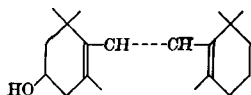

**Rubixanthin**, C<sub>40</sub>H<sub>56</sub>O, m.p. 160°, is monohydroxy-γ-carotene, and **lycoxanthin**, C<sub>40</sub>H<sub>56</sub>O, m.p. 168°, appears to be monohydroxylycopene.

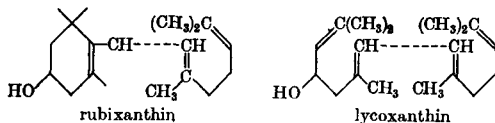

**Rhodoxanthin**, C<sub>40</sub>H<sub>52</sub>O<sub>2</sub>, m.p. 219°, is believed to be the following diketone.

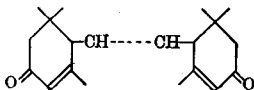

**Lutein**,  $C_{40}H_{56}O_2$ , m.p.  $193^\circ$ , was formerly known as xanthophyll; it is dihydroxy- $\alpha$ -carotene.

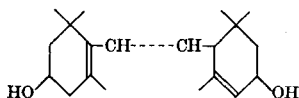

**Zeaxanthin**, m.p.  $205^\circ$ , and **lycophyll**, m.p.  $179^\circ$ , are the corresponding dihydroxy derivatives of  $\beta$ -carotene and lycopene, respectively.

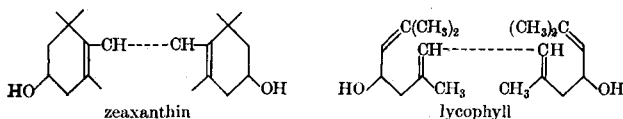

§9. **Carotenoid acids.** These are compounds which do not contain 40 carbon atoms.

**Bixin**,  $C_{25}H_{30}O_4$ . Natural bixin is a brown solid, m.p.  $198^\circ$ , and is the *cis*-form; it is readily converted into the more stable *trans*-form, m.p.  $216$ – $217^\circ$ .

When boiled with potassium hydroxide solution, bixin produces one molecule of methanol and a dipotassium salt which, on acidification, gives the dibasic acid **norbixin**,  $C_{24}H_{28}O_4$ . Thus bixin is a monomethyl ester, and can be esterified to give methylbixin.

On catalytic hydrogenation, bixin is converted into perhydrobixin,  $C_{25}H_{48}O_4$ ; thus there are 9 double bonds present in the molecule (Liebermann *et al.*, 1915). Perhydrobixin, on hydrolysis, forms perhydronorbixin. Oxidation of bixin with permanganate produces four molecules of acetic acid (Kuhn *et al.*, 1929); thus there are four  $-\text{C}(\text{CH}_3)=$  groups in the chain. Furthermore, since the parent hydrocarbon of perhydronorbixin,  $C_{24}H_{46}O_4$ , is  $C_{22}H_{46}$  (the two carboxyl groups are regarded as substituents), the molecule is acyclic.

The thermal decomposition of bixin produces toluene, *m*-xylene, *m*-toluic acid and the methyl ester of this acid (Kuhn *et al.*, 1932). Hence the following assumptions may be made regarding the nature of the chain (*cf.*  $\beta$ -carotene, §3).

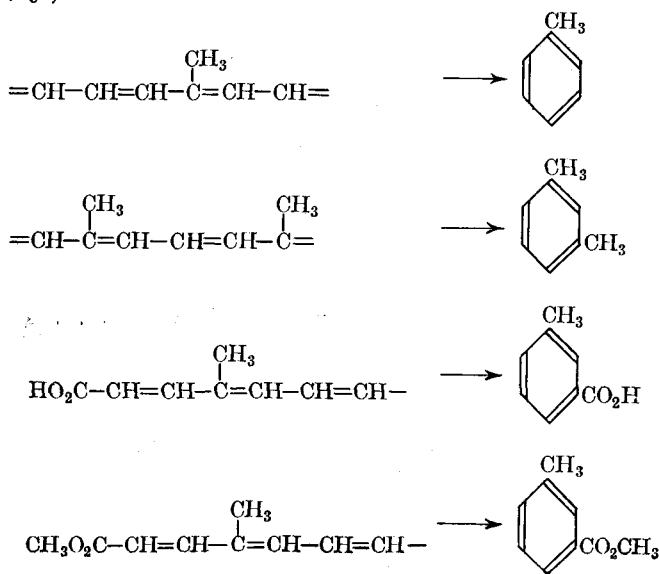

The foregoing facts may be explained by assuming the following structure for bixin (Kuhn *et al.*, 1932):

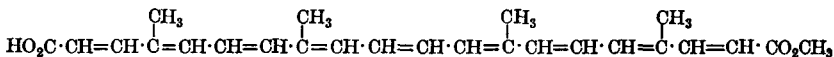

This structure is supported by the fact that perhydronorbixin has been synthesised, and shown to be identical with the compound obtained from the reduction of bixin (Karrer *et al.*, 1933). Further proof is the synthesis of norbixin (Isler *et al.*, 1957).

Jackman *et al.* (1960) have shown, from an examination of the NMR spectra (§19a. I) of many carotenoids, that the positions of the absorption bands resulting from the methyl groups give some indication of the molecular environment of these groups. "Natural" methylbixin is the *cis*-isomer of the following *trans*-isomer:

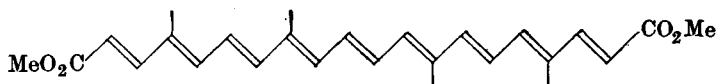

The methyl ester of crocetin (see below) also probably has the *cis*-configuration at the corresponding 2,3-position.

**Crocetin**,  $\text{C}_{20}\text{H}_{24}\text{O}_4$ . Crocetin occurs in saffron as the digentiobioside, *crocin*. The structure of crocetin was elucidated by Karrer *et al.* (1928) and Kuhn *et al.* (1931). Crocetin behaves as a dicarboxylic acid and has seven double bonds (as shown by catalytic hydrogenation to perhydrocrocetin,  $\text{C}_{20}\text{H}_{38}\text{O}_4$ ). On oxidation with chromic acid, crocetin gives 3-4 molecules of acetic acid per molecule of crocetin; thus there are 3-4 methyl side-chains. The structure of crocetin was finally shown by the degradation of perhydronorbixin,  $\text{C}_{24}\text{H}_{46}\text{O}_4$ , by means of the following method:

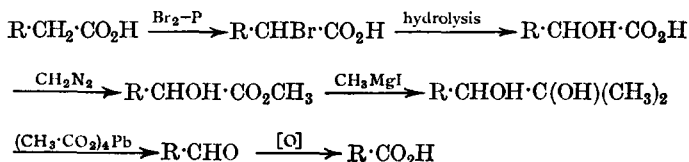

This set of reactions was performed *twice* on perhydronorbixin, thereby resulting in the loss of four carbon atoms (two from each end); the product so obtained was perhydrocrocetin,  $\text{C}_{20}\text{H}_{38}\text{O}_4$ . On these results, crocetin is therefore:

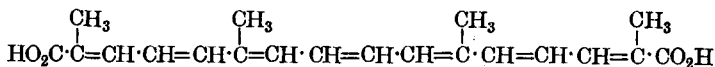

This structure is supported by the fact that the removal of two carbon atoms from perhydrocrocetin by the above technique (one carbon atom is lost from each end) resulted in the formation of a *diketone*. The formation of this compound shows the presence of an  $\alpha$ -methyl group at each end of the molecule. The structure of crocetin is further supported by the synthesis of perhydrocrocetin, and by the synthesis of crocetin diesters by Isler *et al.* (1957). These diesters probably have the *cis*-configuration at the 2,3-position (see bixin, above). The *trans*-crocetin dimethyl ester has been synthesised by the Wittig reaction (a carbonyl group is exchanged for a methylene group; Vol. I) between the dialdehyde and two molecules of the phosphorane (Buchta *et al.*, 1959, 1960).

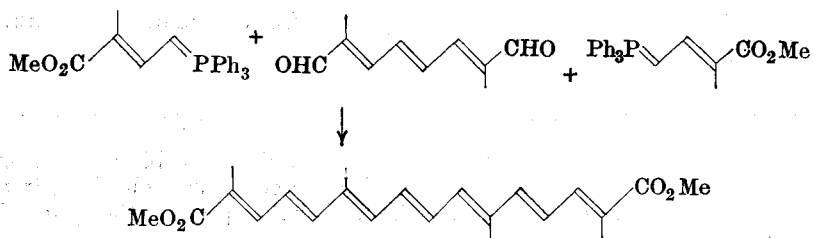

## READING REFERENCES

- Karrer and Jucker, *Carotenoids*, Elsevier (translated and revised by Braude, 1950).
- Rodd (Ed.), *Chemistry of the Carbon Compounds*, Elsevier. Vol. 11A (1953). Ch. 10. The Carotenoid Group.
- Gilman (Ed.), *Advanced Organic Chemistry*, Wiley. Vol. IV (1953). Ch. 7. The Terpenes (see the section on Tetraterpenes).
- Bentley, *The Natural Pigments*, Interscience (1960).

CHAPTER X

POLYCYCLIC AROMATIC HYDROCARBONS

§1. **Introduction.** Naphthalene, anthracene, phenanthrene, fluorene, etc., have been described in Volume I. All these compounds occur in coal-tar, but also present are many polycyclic hydrocarbons containing four or more rings, and others of this type have been synthesised.

§2. **General methods of preparation of polycyclic hydrocarbons.** Before dealing with a number of individual hydrocarbons, it is instructive to review some of the general methods whereby these polycyclic hydrocarbons may be prepared (see also Vol. I).

(i) **Fittig reaction**, *e.g.*, anthracene and phenanthrene may be prepared by the action of sodium on *o*-bromobenzyl bromide.

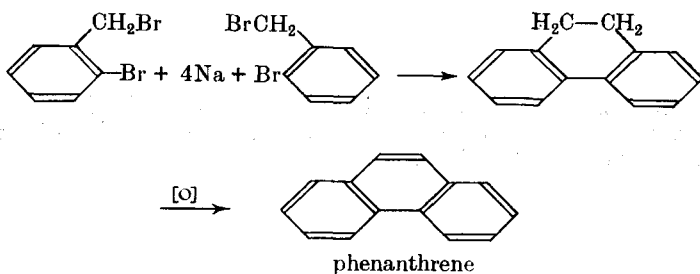
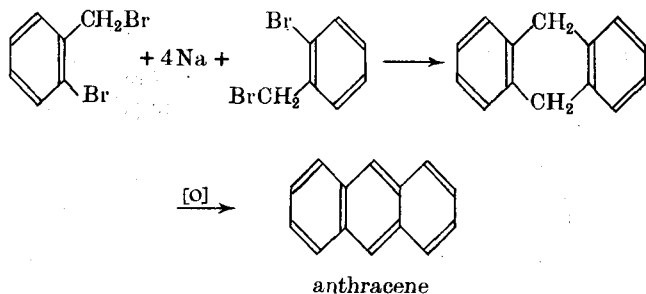

(ii) **Ullmann diaryl synthesis.** This method results in the formation of isolated polynuclear compounds, *e.g.*, heating iodobenzene with copper powder in a sealed tube produces diphenyl.



Compounds of the isolated system type can, under suitable conditions, be converted into condensed polycyclic compounds (see method iii). In certain cases, the Ullmann synthesis leads to condensed systems (see §4c).

(iii) Many compounds of the isolated system type can be converted into condensed systems by strong heating, *e.g.*, *o*-methyldiphenyl forms fluorene. 2 : 2'-Dimethyldiphenyl forms phenanthrene when passed through a red-hot

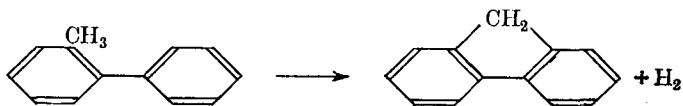

tube, but a much better yield is obtained when the dimethyldiphenyl is heated with sulphur. The latter is an example of cyclodehydrogenation (see also method vii).

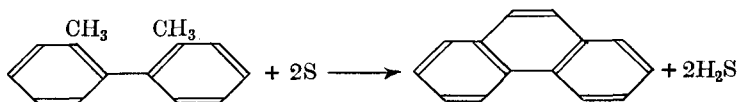
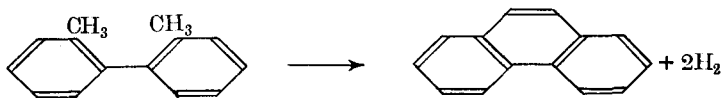

(iv) **Friedel-Crafts reaction.** Condensed polycyclic compounds may be prepared *via* an external or an internal Friedel-Crafts reaction. An example of the former is the preparation of anthracene from benzyl chloride; an example of the latter is the preparation of phenanthraquinone from benzil.

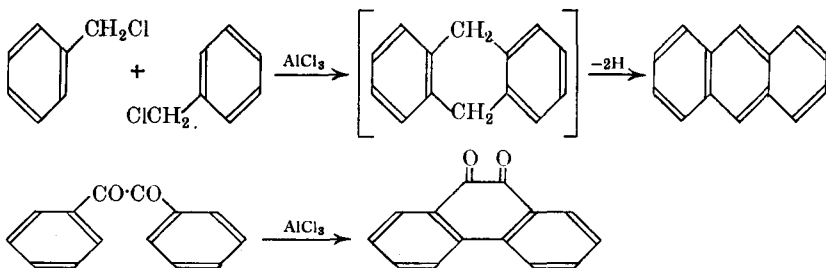

A very important case of the internal Friedel-Crafts reaction is that in which ring closure is effected on acid chlorides, *e.g.*, the conversion of  $\gamma$ -phenylbutyryl chloride to  $\alpha$ -tetralone.

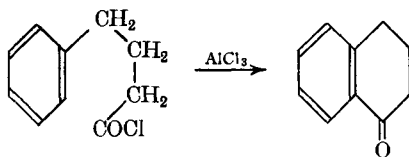

This type of ring closure may be effected by the action of concentrated sulphuric acid on the carboxylic acid itself, *e.g.*,

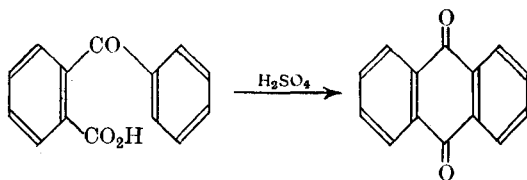

(v) **Elbs reaction.** In this method, polynuclear hydrocarbons are produced from a diaryl ketone containing a methyl group in the *o*-position to the keto group. The reaction is usually carried out by heating the ketone under reflux or at 400–450° until water is no longer evolved, *e.g.*, *o*-methylbenzophenone forms anthracene.

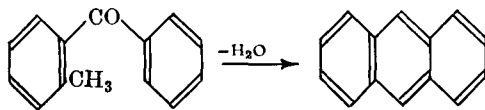

(vi) **Phenanthrene syntheses.** The phenanthrene nucleus is particularly important in steroid chemistry, and so a number of methods for synthesising phenanthrene are dealt with in some detail.

(a) **Pschorr synthesis (1896).** This method offers a means of preparing phenanthrene and substituted phenanthrenes with the substituents in known positions. Phenanthrene may be prepared as follows, starting with *o*-nitrobenzaldehyde and sodium  $\beta$ -phenylacetate.

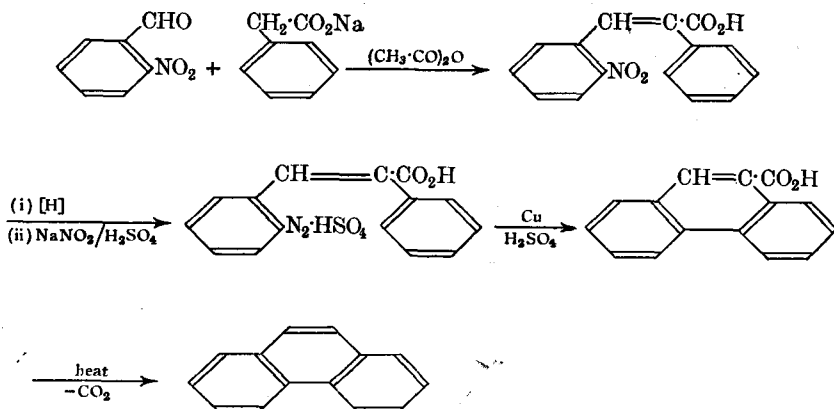

(b) **Haworth synthesis (1932).** Naphthalene is condensed with succinic anhydride in the presence of aluminium chloride in nitrobenzene solution. Two naphthoylpropionic acids are obtained, and these may be separated (see next page).

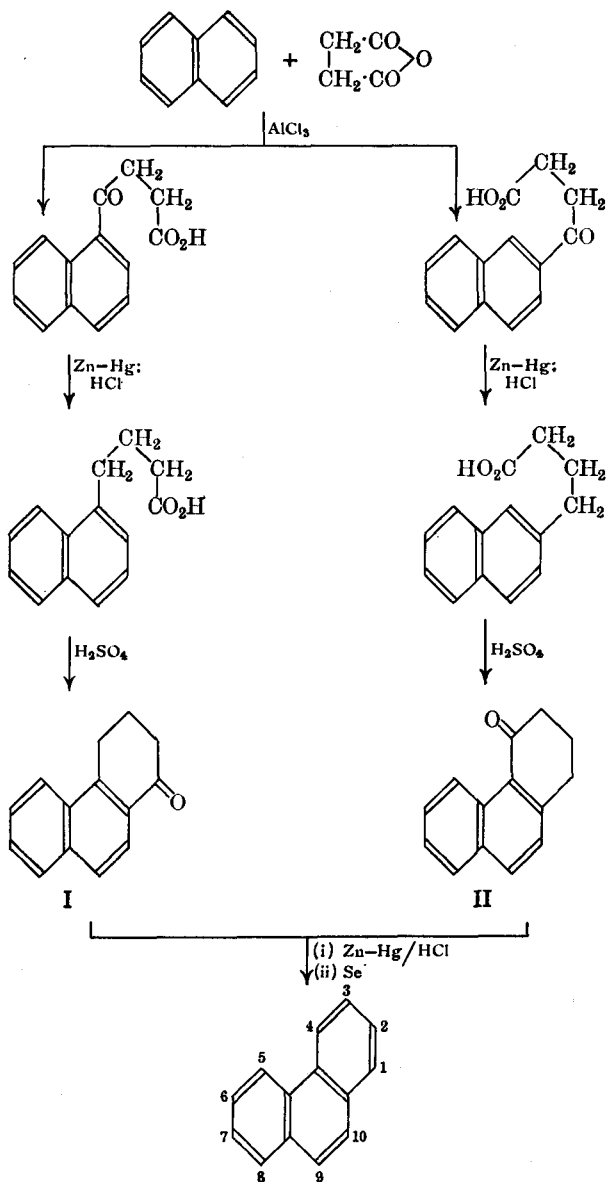

The Haworth synthesis is very useful for preparing alkylphenanthrenes with the alkyl group in position 1 (from I) or position 4 (from II); *e.g.*,

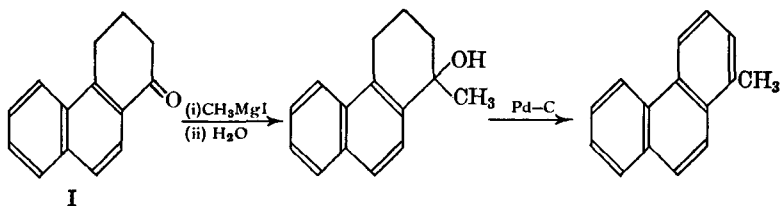



By using methylsuccinic anhydride instead of succinic anhydride, a methyl group can be introduced into the 2- or 3-position; in this case the condensation occurs at the less hindered keto group, *i.e.*, at the one which is farther removed from the methyl substituent.

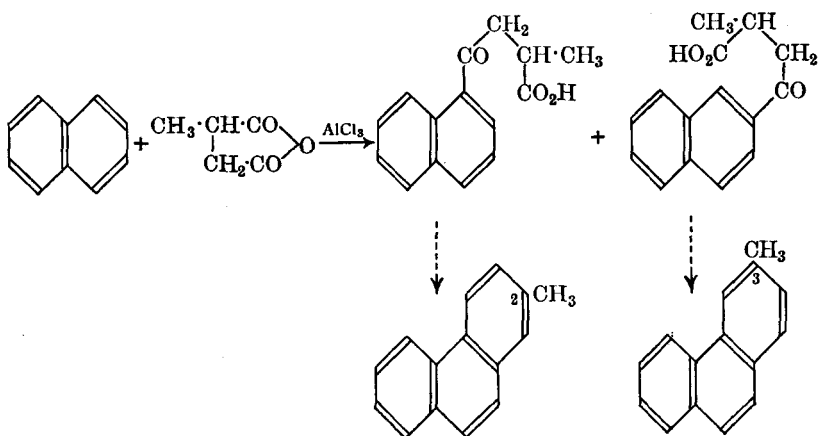

$\alpha$ -Bromoketone derivatives of naphthalene may be used in the malonic ester synthesis to prepare alkylphenanthrenes, *e.g.*,

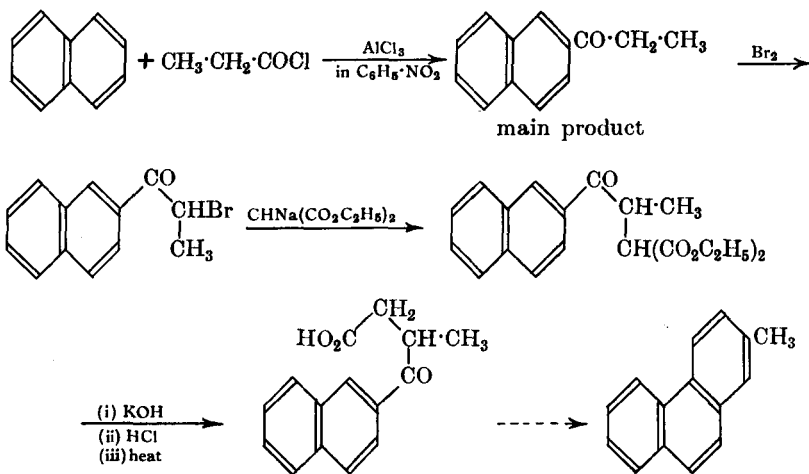

(c) **Stobbe condensation** (1893). This method has been improved by Johnson (1944), and has been used to prepare phenanthrene derivatives (see Vol. I); *e.g.*,

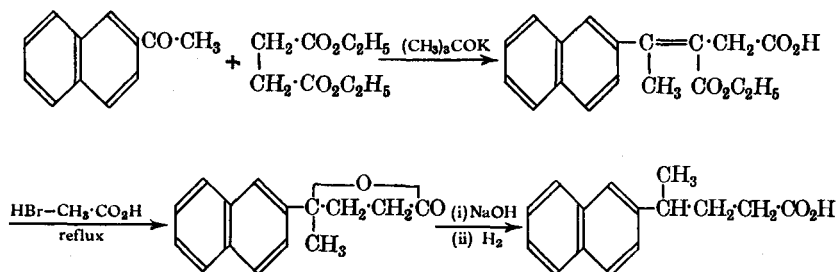

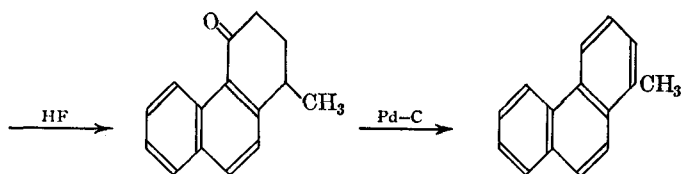

(d) **Bardhan-Sengupta synthesis** (1932). In this synthesis the starting materials are 2-phenylethyl bromide and ethyl cyclohexane-2-carboxylate; these may be prepared as follows:

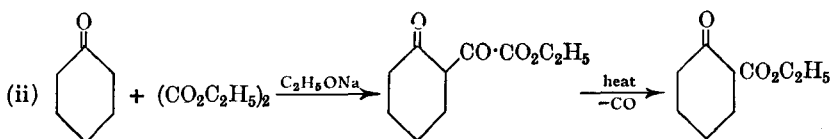
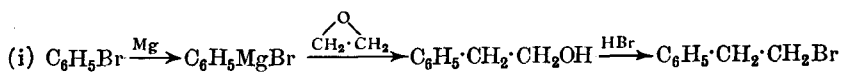

These two compounds are then treated as shown:

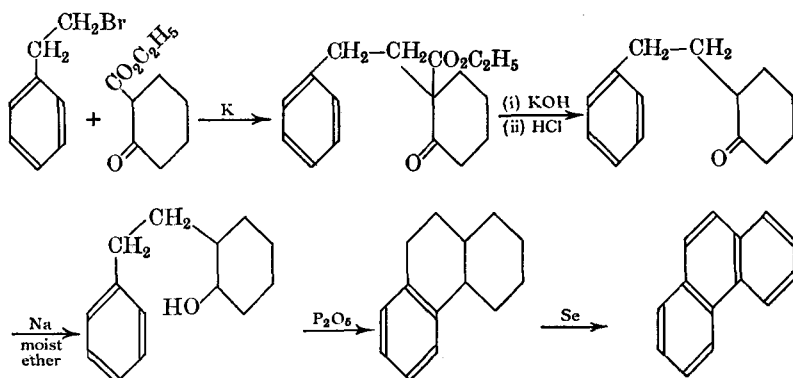

(e) **Bogert-Cook synthesis** (1933). The following chart shows the preparation of phenanthrene.

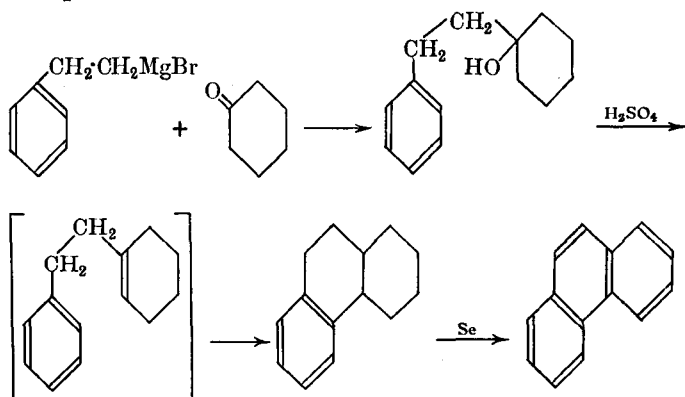

It might be noted here that the Bardhan-Sengupta and Bogert-Cook methods

both proceed *via* the formation of olefin III, which then gives a mixture of octahydrophenanthrene IV and the spiran V.

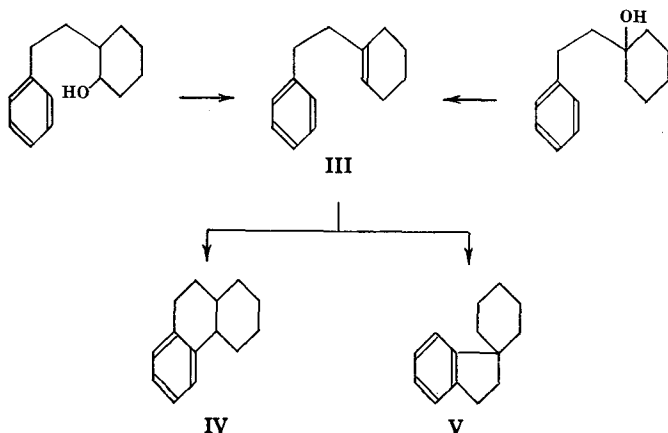

(vii) **Dehydrogenation of hydroaromatic compounds with sulphur, selenium or palladised charcoal.** This method is mainly confined to the dehydrogenation of six-membered rings, but five-membered rings may sometimes be dehydrogenated when they are fused to a six-membered ring. The general methods are as follows:

(a) Heating the compound with the calculated amount of sulphur at 200–220°; hydrogen is eliminated as hydrogen sulphide (Vesterberg, 1903).

(b) Heating the compound with the calculated amount of selenium at 250–280°; hydrogen is eliminated as hydrogen selenide (Diels, 1927).

(c) Heating the compound with palladium-charcoal up to about 300°, or passing the vapour of the compound over the catalyst heated at 180–350°; hydrogen is eliminated catalytically. Simple examples of catalytic dehydrogenation are:

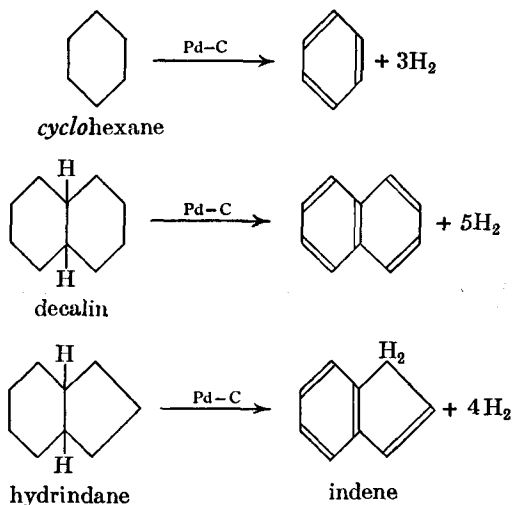

Perhydro-compounds, *i.e.*, fully hydrogenated compounds, are readily dehydrogenated catalytically, but are very little affected, if at all, by the chemical reagents sulphur and selenium. Partially unsaturated compounds, however, are readily dehydrogenated by sulphur and selenium.

The method of dehydrogenation has been very useful in the elucidation of structure in terpene and steroid chemistry; specific examples are described in these two chapters. The following is an account of some of the general problems involved in dehydrogenation.

Originally, dehydrogenation was applied almost entirely to hydrocarbons, but subsequently it was found that many compounds containing certain functional groups could also be dehydrogenated, the nature of the products depending on the nature of the functional group.

(i) Alcoholic groups may be eliminated with the formation of unsaturated hydrocarbons, *e.g.*, eudesmol gives eudalene (§28b. VIII); cholesterol gives Diels' hydrocarbon (§1. XI).

(ii) Phenolic hydroxyl groups and methylated phenolic groups are usually unaffected by dehydrogenation with sulphur. With selenium, these groups may or may not be eliminated, but the higher the temperature at which the dehydrogenation is carried out (particularly above 300°), the greater the likelihood of these groups being eliminated.

(iii) The products obtained from ketones depend on whether the keto group is in a ring or in an open chain. Thus cyclic ketones are dehydrogenated to phenols, *e.g.*,

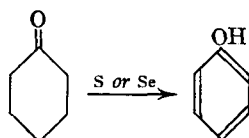

When the keto group is in a side-chain, then it is often unaffected.

(iv) Carboxyl (or carboalkoxyl) groups are eliminated when attached to a tertiary carbon atom, *e.g.*, abietic acid gives retene (§31. VIII). If, however, the carboxyl group is attached to a primary or secondary carbon atom, it is usually unaffected when the dehydrogenation is carried out with sulphur or palladium-charcoal. On the other hand, the carboxyl group is usually eliminated (decarboxylation) when selenium is used, but in some cases it is converted into a methyl group (see, *e.g.*, vitamin D, §6. XI).

(v) In a number of cases, dehydrogenation is accompanied by a rearrangement of the carbon skeleton, this tending to occur at higher temperatures and when the heating is prolonged.

(a) Ring contraction may occur, *e.g.*,

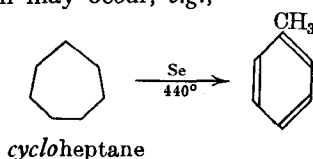

(b) Ring expansion may occur, *e.g.*, cholesterol gives chrysene (see §1. XI).

(c) Compounds containing an *angular* methyl group tend to eliminate this methyl group as  $\text{CH}_3\text{SH}$  or  $\text{CH}_3\text{SeH}$ , *e.g.*, eudesmol gives eudalene (§28b. VIII), cholesterol gives Diels' hydrocarbon (§1. XI). In some cases, the angular methyl group enters a ring,

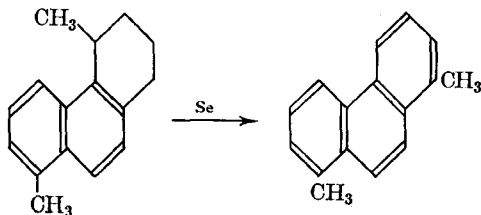

thereby bringing about ring expansion [cf. (b) above]. On the other hand, a normal substituent methyl group may migrate to another position, e.g., 5 : 6 : 7 : 8-tetrahydro-1 : 5-dimethylphenanthrene gives 1 : 8-dimethylphenanthrene on dehydrogenation with selenium.

(d) Side-chains larger than methyl may remain intact, or be eliminated or be degraded, e.g.,



(e) Dehydrogenation may produce new rings (cf. method iii); e.g.,

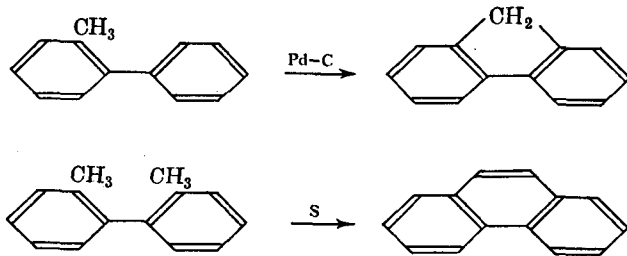

### BENZANTHRACENES

§3. **Naphthacene** (2 : 3-Benzanthracene),  $C_{18}H_{12}$ , is an orange solid, m.p. 357°. It occurs in coal-tar, and has been synthesised as follows (Fieser, 1931).

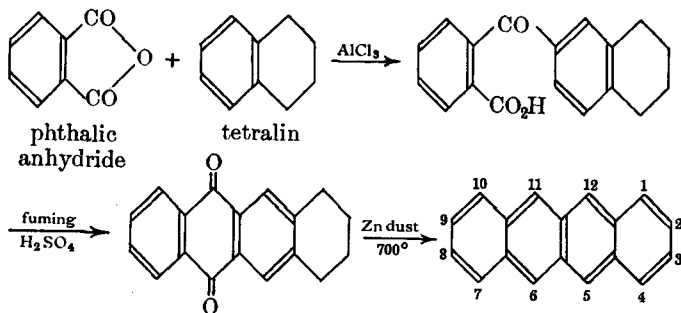

When oxidised with fuming nitric acid, naphthalene forms naphthalene-quinone.

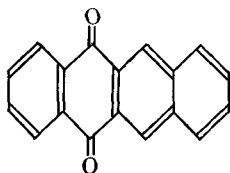

§3a. **Rubrene** (5 : 6 : 11 : 12-tetraphenylnaphthalene) may be prepared by heating 3-chloro-1 : 3 : 3-triphenylprop-1-yne alone, or better, with quinoline at  $120^\circ$  *in vacuo* (Dufraisse *et al.*, 1926).

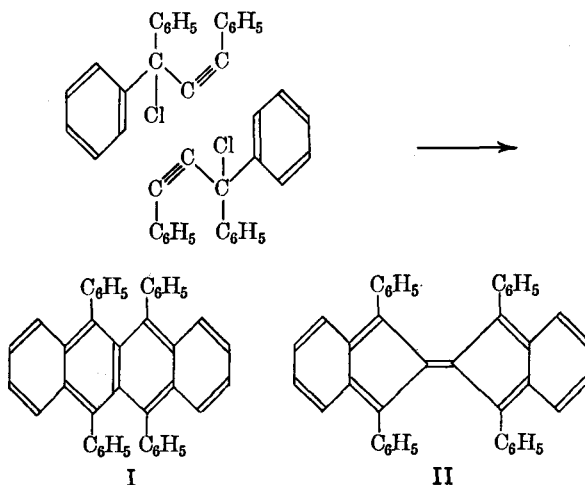

It is interesting to note that Dufraisse originally gave rubrene structure II, but changed it to I in 1935. The mechanism of the reaction is uncertain.

Rubrene is an orange-red solid, m.p.  $334^\circ$ . Its solution in benzene has a yellow fluorescence, but when this solution is shaken with air in sunlight, the fluorescence slowly disappears, and a white solid can now be isolated. This is rubrene peroxide, and when heated to  $100\text{--}140^\circ$  in a high vacuum, it emits yellow-green light and evolves oxygen, reforming rubrene.

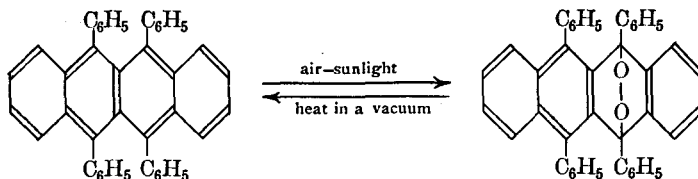

Rubrene peroxide is actually a derivative of 5 : 12-dihydronaphthalene, and so the molecule is not flat but folded about the O-O axis (the carbon atoms at 5 and 12 are tetrahedrally hybridised).

§3b. Two linear benzene derivatives of naphthalene have been prepared, *viz.*, **pentacene** (a deep violet-blue solid) and **hexacene** (a deep-green solid) [Clar, 1930, 1939].

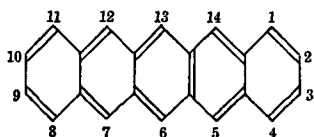

pentacene

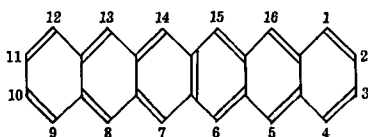

hexacene

Clar (1942) thought he had prepared heptacene, but in 1950 he showed that the compound he had isolated was 1 : 2-benzohexacene. Bailey *et al.* (1955) have synthesised heptacene.

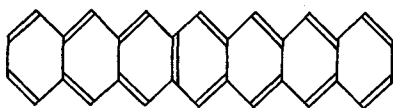

heptacene

§3c. 1 : 2-Benzanthracene, m.p. 160°, occurs in coal-tar, and has been synthesised as follows (Bachmann, 1937).

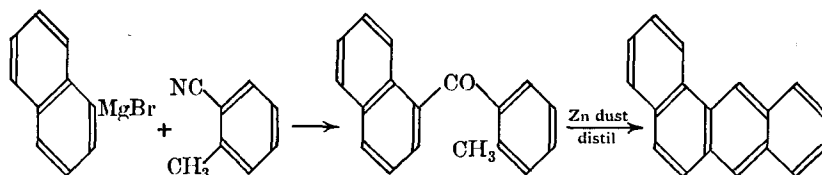
1-naphthalene-  
magnesium  
bromide

§3d. 1 : 2 : 5 : 6-Dibenzanthracene, m.p. 266°, has been synthesised by Cook *et al.* (1931), who showed that it had strong carcinogenic activity.

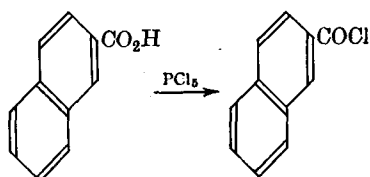
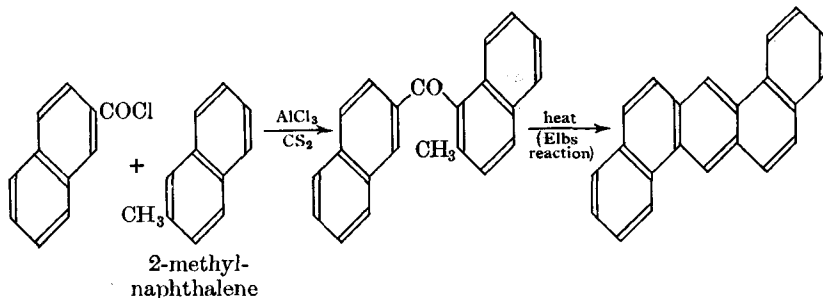
2-naphthoic  
acid2-methyl-  
naphthalene

Buu-Hoï *et al.* (1960) have shown that picene (§4a) is converted into 1:2:5:6-dibenzanthracene by aluminium chloride in benzene.

§3e. **3:4-Benzpyrene** is a pale yellow solid, m.p. 179°, which is very strongly carcinogenic. It occurs in coal-tar, and has been synthesised as follows from pyrene (see §4b).

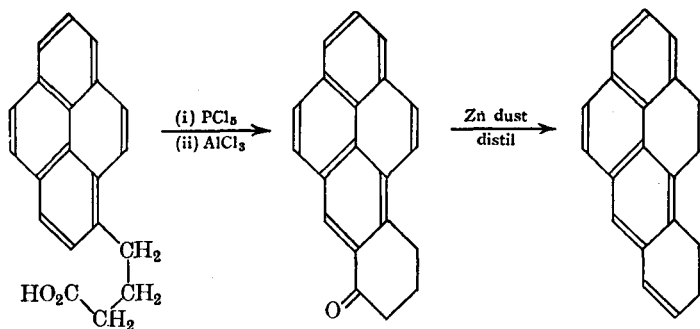
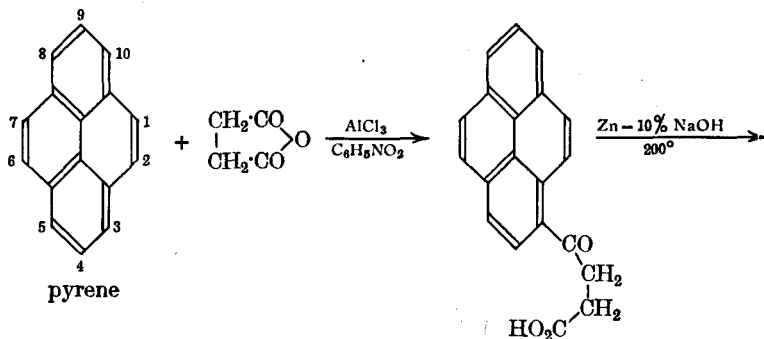

§3f. **20-Methylcholanthrene** is a pale yellow solid, m.p. 180°. It is a steroid derivative, and has been prepared by the degradation of, *e.g.*, cholesterol (see §3 iii. XI). Cook (1934) showed that methylcholanthrene has powerful carcinogenic properties, and Fieser *et al.* (1935) synthesised it in the following way:



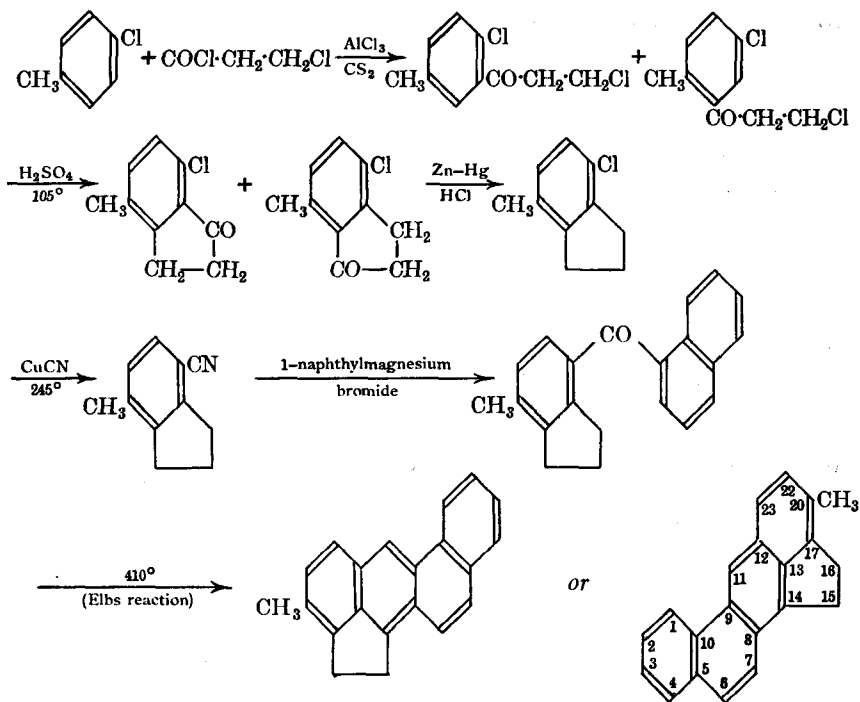

The alternative way of writing the formula shows more clearly the relationship of methylcholanthrene to the steroids (see §3. XI for the method of numbering in cholesterol). The steroids are phenanthrene derivatives, and so methylcholanthrene may also be regarded as a phenanthrene derivative (instead of an anthracene derivative).

#### PHENANTHRENE DERIVATIVES

§4. **Chrysene** (1:2-benzphenanthrene) is a colourless solid, m.p. 251°. It occurs in coal-tar, and has been synthesised in several ways:

(i) By strongly heating 2-[1-naphthyl]-1-phenylethane.

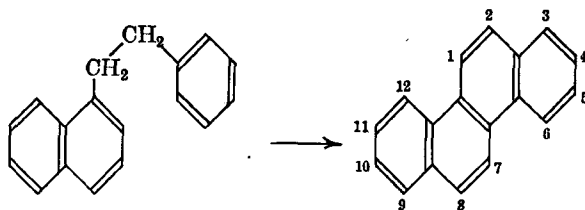

(ii) By a Bogert-Cook synthesis (*cf.* §2. (vi) *e*).

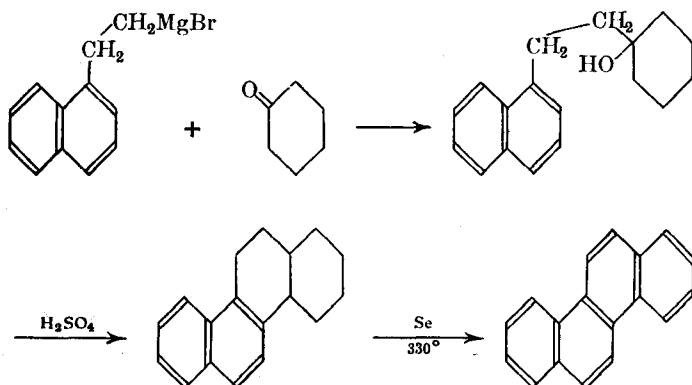

(iii) By a Pschorr synthesis [*cf.* §2 (vi) *a*].

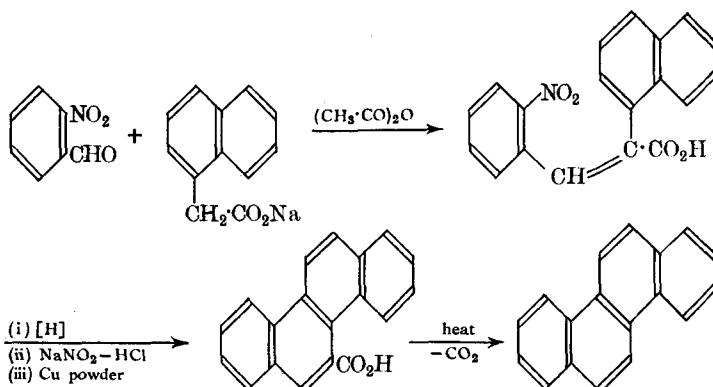

(iv) Phillips (1956) has prepared chrysene from naphthalene and the lactone of *trans* 2-hydroxycyclohexaneacetic acid:

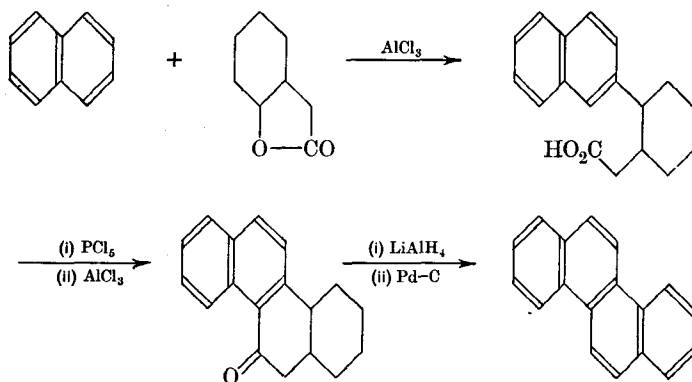

Chrysene is produced by the pyrolysis of indene, and also by the dehydrogenation of steroids with selenium.

§4a. **Picene** (1 : 2 : 7 : 8-dibenzphenanthrene), m.p.  $365^\circ$ , is obtained when cholesterol or cholic acid is dehydrogenated with selenium. It has been

synthesised by heating 1-methylnaphthalene with sulphur at 300° (see also §3d).

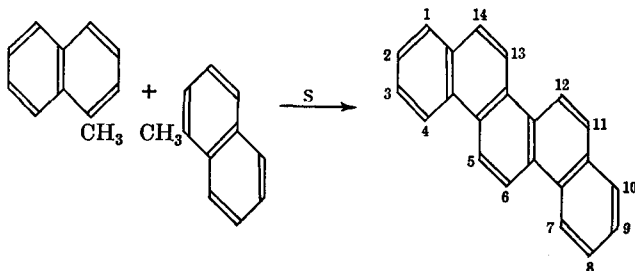

§4b. **Pyrene** is a colourless solid, m.p. 150°. It occurs in coal-tar, and has been synthesised from diphenyl-2 : 2'-diacetyl chloride as follows:

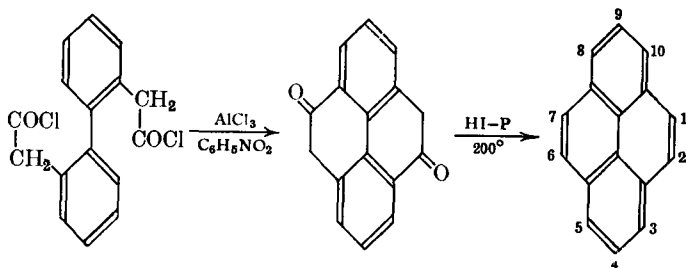

Buchta *et al.* (1958) have synthesised pyrene using an internal Stobbe reaction [§2 (vi) c]:

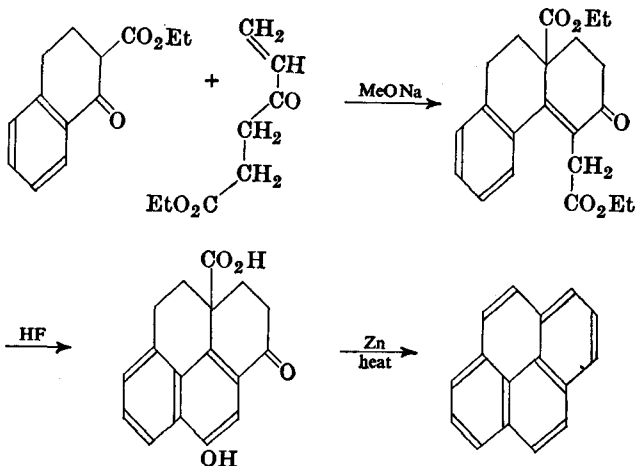

§4c. **Perylene** is a very pale yellow solid, m.p. 273°. It occurs in coal-tar, and has been synthesised in several ways.

(i) 2-Naphthol, on treatment with ferric chloride solution, forms 1 : 1'-dinaphthol, and this, on heating with a mixture of phosphorus pentachloride and phosphorous acid, gives perylene.

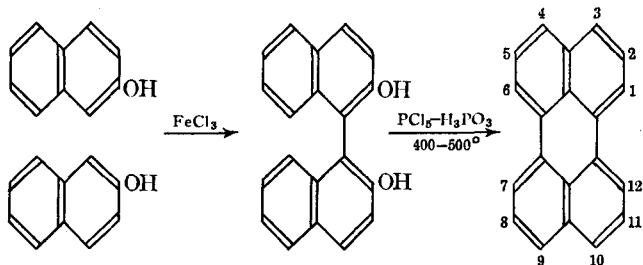

(ii) Perylene may also be prepared by heating 1 : 8-di-iodonaphthalene with copper powder (*i.e.*, by an Ullmann synthesis; *cf.* §2. ii).

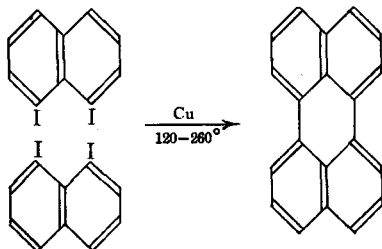

(iii) Perylene is formed when 1 : 1'-dinaphthyl is heated with hydrogen fluoride under pressure.

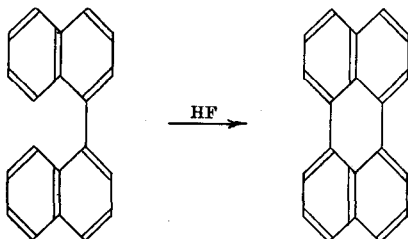

Robertson *et al.* (1953), by X-ray analysis of perylene, have shown that the two bonds connecting the two naphthalene units are longer (1.50 Å) than the usual aromatic C—C bond (1.38–1.44 Å). The existence of these long bonds is supported by some magnetic susceptibility measurements (Hazato, 1949).

§4d. **Coronene**, m.p.  $430^\circ$ , is a yellow solid with a blue fluorescence in benzene solution; it has been found in coal-gas (Lindsay *et al.*, 1956). It was synthesised by Scholl *et al.* (1932), starting from *m*-xylene and anthraquinone-1 : 5-dicarbonyl chloride, the latter behaving in the tautomeric form shown in the following chart.

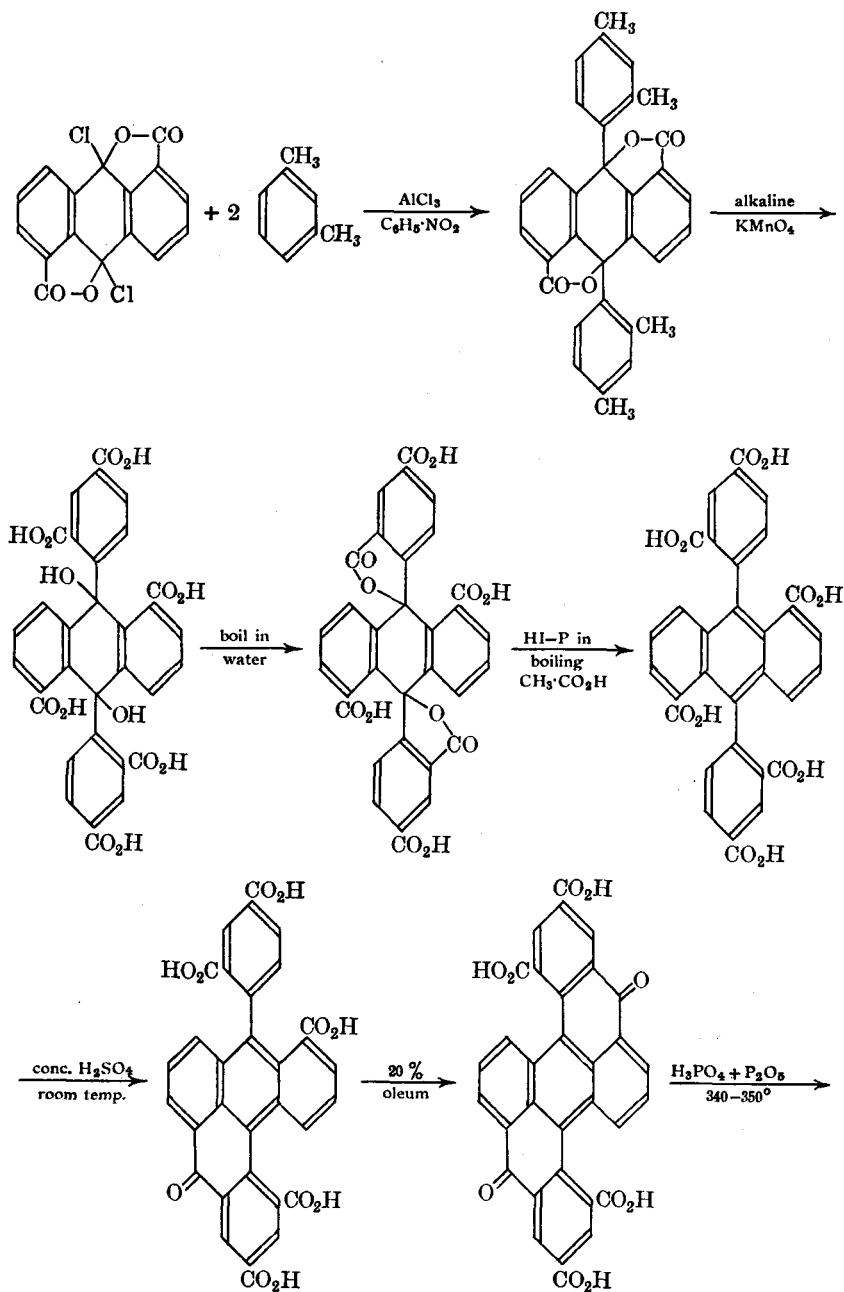

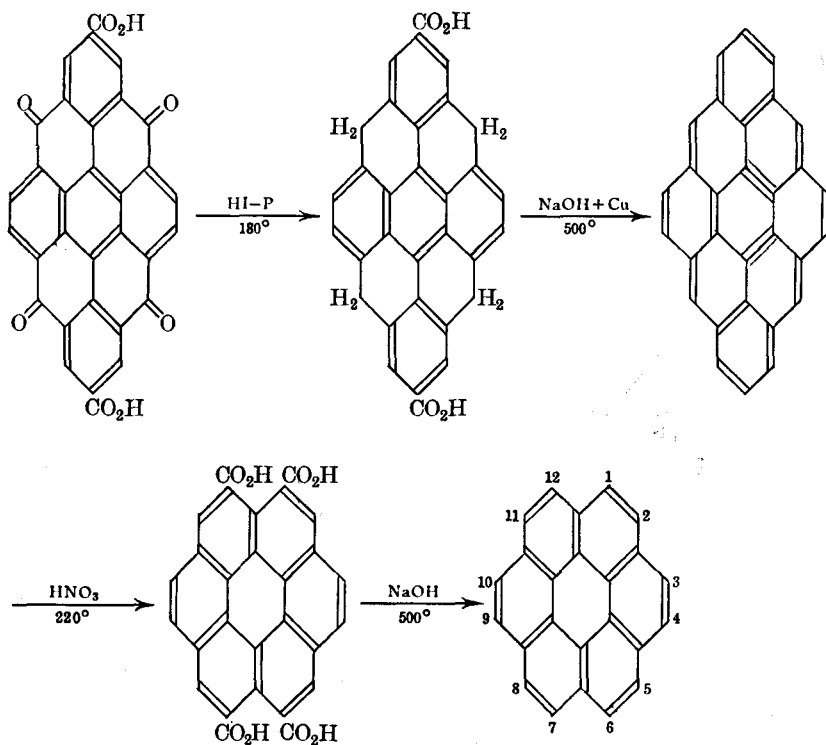

Newman (1940) has also synthesised coronene, starting from 7-methyl-tetralone, and proceeding as follows:

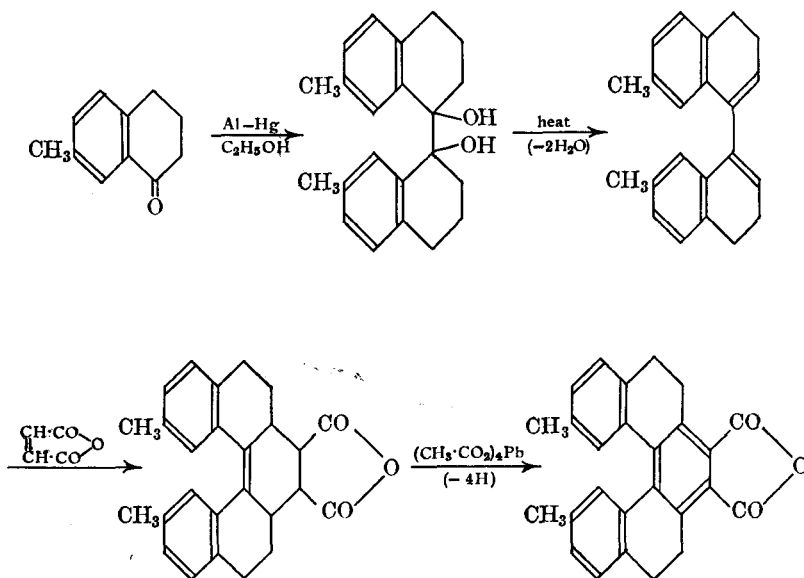

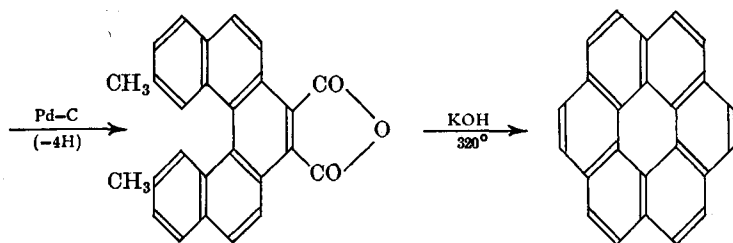

The simplest and most efficient synthesis of coronene appears to be that of Clar *et al.* (1957). The starting material is perylene (§4c), and this is treated with (i) maleic anhydride and chloranil, and followed by (ii) heating with soda-lime; these processes are then repeated:

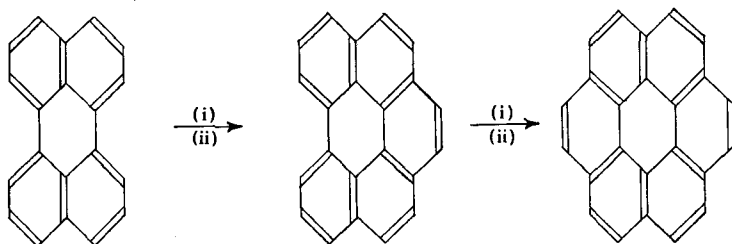

#### READING REFERENCES

- Newer Methods of Preparative Organic Chemistry*, Interscience Publishers (1948). Dehydrogenation with Sulphur, Selenium and Platinum Metals (pp. 21-59).
- Gilman (Ed.), *Advanced Organic Chemistry*, Wiley. Vol. IV (1953), pp. 1232- . Dehydrogenating Agents.
- Genie, La Cyclodéshydrogénation Aromatique, *Ind. chim. belg.*, 1953, 18, 670.
- Cook, Polycyclic Aromatic Hydrocarbons, *J.C.S.*, 1950, 1210.
- Traité de Chimie Organique*, Masson et Cie., Vol. XVII. Part II (1949).
- Encyclopædia of Organic Chemistry*, Elsevier. Vol. 14 (1940). Tetracyclic and Higher-Cyclic Compounds. See also Vol. 14 Supplement (1951).
- Cocker, Cross *et al.*, The Elimination of Non-angular Alkyl Groups in Aromatisation Reactions. Part II. *J.C.S.*, 1953, 2355.
- Cook (Ed.), *Progress in Organic Chemistry*, Butterworth. Vol. 2 (1953). Ch. 5. The Relationship of Natural Steroids to Carcinogenic Aromatic Compounds.
- Badger, *The Structures and Reactions of Aromatic Compounds*, Cambridge Press (1954).

CHAPTER XI  
STEROIDS

§1. **Introduction.** The steroids form a group of structurally related compounds which are widely distributed in animals and plants. Included in the steroids are the sterols (from which the name *steroid* is derived), vitamin D, the bile acids, a number of sex hormones, the adrenal cortex hormones, some carcinogenic hydrocarbons, certain sapogenins, etc. The structures of the steroids are based on the 1:2-cyclopentenophenanthrene skeleton (Rosenheim and King, 1932; Wieland and Dane, 1932). All the steroids

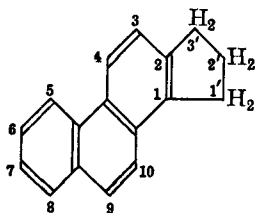

1:2-cyclopentenophenanthrene

give, among other products, Diels' hydrocarbon on dehydrogenation with selenium at 360° (Diels, 1927). In fact, a steroid could be defined as any compound which gives Diels' hydrocarbon when distilled with selenium. When the distillation with selenium is carried out at 420°, the steroids give mainly chrysene (§4. X) and a small amount of picene (§4a. X).

**Diels' hydrocarbon** is a solid, m.p. 126–127°. Its molecular formula is  $C_{18}H_{16}$ , and the results of oxidation experiments, X-ray crystal analysis and absorption spectrum measurements showed that the hydrocarbon is probably 3'-methyl-1:2-cyclopentenophenanthrene. This structure for the compound was definitely established by synthesis, *e.g.*, that of Harper, Kon and Ruzicka (1934) who used the Bogert–Cook method [§2 (vi) *e.* X], starting from 2-(1-naphthyl)-ethylmagnesium bromide and 2:5-dimethylcyclopentanone.

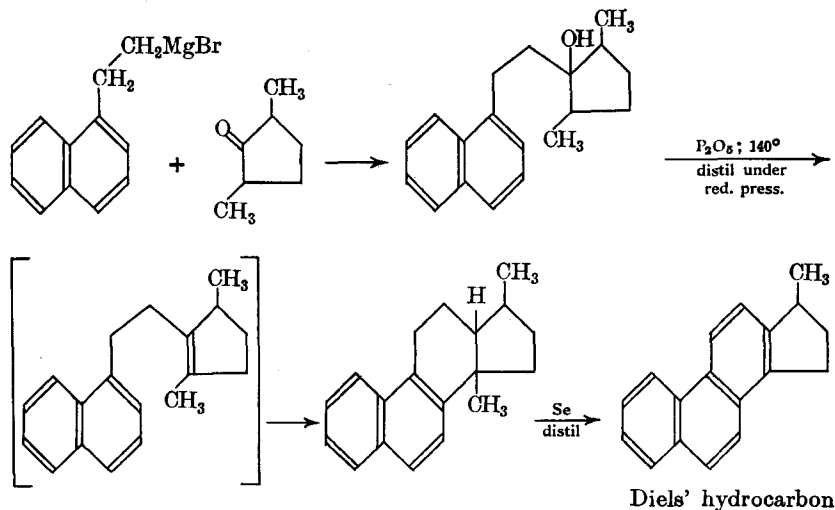

Diels' hydrocarbon



## STEROLS

§2. Sterols occur in animal and plant oils and fats. They are crystalline compounds, and contain an alcoholic group; they occur free or as esters of the higher fatty acids, and are isolated from the unsaponifiable portion of oils and fats. Cholesterol, cholestanol and coprostanol (coprosterol) are the animal sterols; ergosterol and stigmasterol are the principal plant sterols. The sterols that are obtained from animal sources are often referred to as the *zoosterols*, and those obtained from plant sources as the *phytosterols*. A third group of sterols, which are obtained from yeast and fungi, are referred to as the *mycoosterols*. This classification, however, is not rigid, since some sterols are obtained from more than one of these groups.

§3. **Cholesterol**,  $C_{27}H_{46}O$ , m.p.  $149^{\circ}$ . This is the sterol of the higher animals, occurring free or as fatty esters in all animal cells, particularly in the brain and spinal cord. Cholesterol was first isolated from human gallstones (these consist almost entirely of cholesterol). The main sources of cholesterol are the fish-liver oils, and the brain and spinal cord of cattle. Lanoline, the fat from wool, is a mixture of cholesteryl palmitate, stearate and oleate.

Cholesterol is a white crystalline solid which is optically active (lævo-rotatory). Cholesterol (and other sterols) gives many colour reactions, *e.g.*,

(i) *The Salkowski reaction* (1908). When concentrated sulphuric acid is added to a solution of cholesterol in chloroform, a red colour is produced in the chloroform layer.

(ii) *The Liebermann-Burchard reaction* (1885, 1890). A greenish colour is developed when a solution of cholesterol in chloroform is treated with concentrated sulphuric acid and acetic anhydride.

When an ethanolic solution of cholesterol is treated with an ethanolic solution of digitonin (a saponin; see §19. iii), a large white precipitate of cholesterol digitonide is formed. This is a molecular complex containing one molecule of cholesterol and one of digitonin, from which the components may be recovered by dissolving the complex in pyridine (which brings about complete dissociation) and then adding ether (the cholesterol remains in solution and the digitonin is precipitated). Digitonide formation is used for the estimation of cholesterol.

The structure of cholesterol was elucidated only after a tremendous amount of work was done, particularly by Wieland, Windaus and their co-workers (1903–1932). Only a very bare outline is given here, and in order to appreciate the evidence that is going to be described, it is necessary to

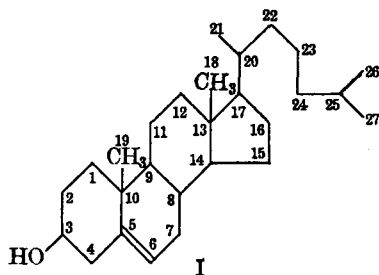

have the established structure of cholesterol at the beginning of our discussion. I is the structure of cholesterol, and shows the method of numbering. The molecule consists of a *side-chain* and a *nucleus* which is composed of four rings; these rings are usually designated A, B, C and D or I, II, III and

IV, beginning from the six-membered ring on the left (see also (iii) below). It should be noted that the nucleus contains two angular methyl groups, one at C<sub>10</sub> and the other at C<sub>13</sub>.

(i) **Structure of the ring system.** Under this heading we shall deal with the nature of the ring system present in cholesterol; the problem of the angular methyl groups is dealt with later [see (iv)].

The usual tests for functional groups showed that cholesterol contains one double bond and one hydroxyl group. Now let us consider the following set of reactions.

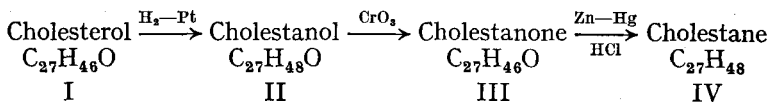

The conversion of cholesterol into cholestanol, II, shows the presence of one double bond in I, and the oxidation of II to the ketone cholestanone, III, shows that cholesterol is a secondary alcohol. Cholestane, IV, is a saturated hydrocarbon, and corresponds to the general formula C<sub>n</sub>H<sub>2n-6</sub>, and consequently is tetracyclic; thus cholesterol is tetracyclic.

When cholesterol is distilled with selenium at 360°, Diels' hydrocarbon is obtained (see §1). The formation of this compound could be explained by assuming that this nucleus is present in cholesterol. The yield of this hydrocarbon, however, is always poor, and other products are always formed at the same time, particularly chrysene (see §1). Thus, on the basis of this dehydrogenation, the presence of the *cyclopentenophenanthrene* nucleus must be accepted with reserve. Rosenheim and King (1932) thought that chrysene was the normal product of the selenium dehydrogenation, and so proposed (on this basis and also on some information obtained from X-ray analysis work of Bernal, 1932; see §4a) that the steroids contained the chrysene skeleton. Within a few months, however, Rosenheim and King (1932) modified this suggestion, as did also Wieland and Dane (1932). These two groups of workers proposed that the *cyclopentenophenanthrene* nucleus is the one present in cholesterol (*i.e.*, in steroids in general). This structure fits far better all the evidence that has been obtained from a detailed investigation of the oxidation products of the sterols and bile acids. This structure has now been confirmed by the synthesis of cholesterol (see later in this section).

Although an account of the oxidative degradation of the steroids cannot be discussed here, the following points in this connection are of some interest.

(i) The nature of the *nucleus* in sterols and bile acids was shown to be the same, since cholanolic acid or *allocholanolic* acid is one of the oxidation products (see §4a for the significance of the prefix *allo*).

(ii) The oxidation of the bile acids led to the formation of products in which various rings were opened. The examination of these products showed that the positions of the hydroxyl groups were limited mainly to three positions, and further work showed that the hydroxyl groups behaved differently towards a given reagent, *e.g.*,

(a) The ease of oxidation of hydroxyl groups to keto groups by means of chromic acid is C<sub>7</sub> > C<sub>12</sub> > C<sub>3</sub>. More recently, Fonken *et al.* (1955) have shown that *tert.*-butyl hypochlorite apparently oxidises the 3-OH group selectively to the keto group; this reaction, however, failed with cholesterol. Sneedon *et al.* (1955) have also shown that the 3-OH group in sterols is oxidised by oxygen-platinum, but not those at 6, 7 or 12.

(b) The three keto groups are not equally readily reduced to a methylene group (by the Clemmensen reduction) or to an alcoholic group (by H<sub>2</sub>-platinum). The ease of reduction is C<sub>3</sub> > C<sub>7</sub> > C<sub>12</sub>. This is also the order

for the ease of hydrolysis or acetylation when these positions are occupied by hydroxyl groups (see also testosterone, §13). More recently, it has been shown that the modified Wolff-Kishner reduction of Huang-Minlon (see Vol. I) on steroid ketones reduces keto groups at 3, 7, 12, 17 and 20, but not at 11. Another interesting point in this connection is that lithium aluminium hydride, in the presence of aluminium chloride, does not reduce unsaturated ketones to alcohols, *e.g.*, cholest-4-en-3-one, under these conditions, is reduced to cholest-3-ene (Broome *et al.*, 1956).

Thus a knowledge of (a) and (b) enabled workers to open the molecule at *different* points by oxidation under the appropriate conditions. This led to a large variety of degradation products, the examination of which enabled the nature of the nucleus to be ascertained.

(c) Blanc's rule was also used to determine the sizes of the various rings, but the failure of the rule in certain cases led to an erroneous formula; *e.g.*, ring C was originally believed to be five-membered. Thus Windaus and Wieland (1928) proposed the following formula for cholesterol, and the uncertain point (at that time) was the nature of the two extra carbon atoms. These were *assumed* to be present as an ethyl group at position 10, but Wieland *et al.* (1930) finally proved that there was no ethyl group at this

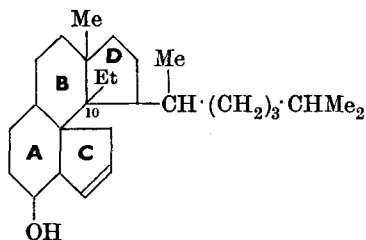

position. These two "homeless" carbon atoms were not placed until Rosenheim and King first proposed that steroids contained the chrysenes nucleus and then proposed the *cyclopentenophenanthrene* nucleus (see above). Bernal (1932) also showed, from the X-ray analysis of cholesterol, ergosterol, etc., that the molecule was thin, whereas the above structure for the steroid nucleus would be rather thick.

(ii) **Positions of the hydroxyl group and double bond.** Let us consider the following reactions:

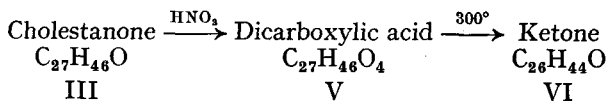

Since the dicarboxylic acid V contains the same number of carbon atoms as the ketone (III) from which it is derived, the keto group in III must therefore be in a ring. Also, since pyrolysis of the dicarboxylic acid V produces a ketone with the loss of one carbon atom, it therefore follows from Blanc's rule that V is either a 1:6- or 1:7-dicarboxylic acid. Now we have seen that the nucleus contains three six-membered rings and one five-membered ring. Thus the dicarboxylic acid V must be obtained by the opening of ring A, B or C, and consequently it follows that the hydroxyl group in cholesterol (which was converted into the keto group in cholestanone; see (i) above) is in ring A, B or C.

Actually *two* isomeric dicarboxylic acids are obtained when cholestanone is oxidised. The formation of these two acids indicates that the keto group

in cholestanone is flanked on either side by a methylene group, *i.e.*, the grouping  $-\text{CH}_2\cdot\text{CO}\cdot\text{CH}_2-$  is present in cholestanone. Examination of the reference structure I of cholesterol shows that such an arrangement is possible only if the hydroxyl group is in ring A.

Now let us consider the further set of reactions:

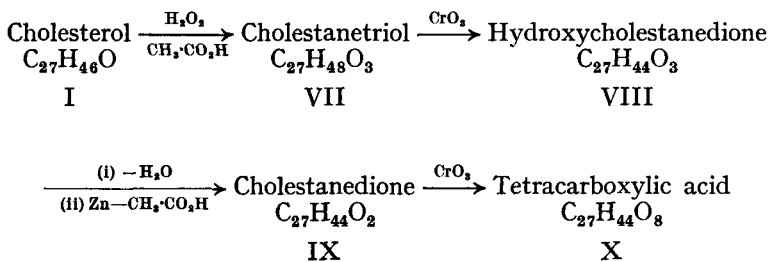

In the conversion of I into VII, the double bond in I is hydroxylated. Since only two of the three hydroxyl groups in VII are oxidised to produce VIII, these two groups are secondary alcoholic groups (one of these being the secondary alcoholic group in cholesterol), and the third, being resistant to oxidation, is probably a tertiary alcoholic group. Dehydration of VIII (by heating *in vacuo*) and subsequent reduction of the double bond forms IX, and this, on oxidation, gives a tetracarboxylic acid *without loss of carbon atoms*. Thus the two keto groups in IX must be in *different* rings; had they been in the *same* ring, then carbon would have been lost and X not obtained. It therefore follows that the hydroxyl group and double bond in cholesterol must be in *different* rings. Furthermore, since IX forms a pyridazine derivative with hydrazine, IX is a  $\gamma$ -diketone. Since we have already tentatively placed the hydroxyl group in ring A, the above reactions can be readily explained if we place the hydroxyl group at position 3, and the double bond between 5 and 6. In the following equations only rings A and B are drawn; this is an accepted convention of focusing attention on any part of the steroid molecule that is under consideration (also note that full lines represent groups lying above the plane, and broken lines groups lying below the plane; see also §§4, 4a, 4b). Noller (1939) has shown that the pyridazine derivative is a polymer, and so the interpretation that IX is a  $\gamma$ -diketone is rendered uncertain. Supporting evidence, however, for the above interpretation is afforded by the fact that when cholesterol is heated with copper oxide at 290°, cholestenone, XI, is produced, and this on oxidation with permanganate forms a keto-acid, XII, with the loss of one carbon atom. The formation of XII indicates that the keto group and the double bond in cholestenone are in the *same* ring. The ultraviolet absorption spectrum of cholestenone shows that the keto group and the double bond are conjugated (Menschick *et al.*, 1932). These results can be explained if we assume that the double bond in cholesterol migrates in the formation of cholestenone, the simplest explanation being that the hydroxyl group

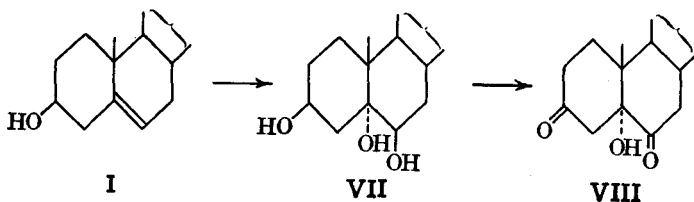

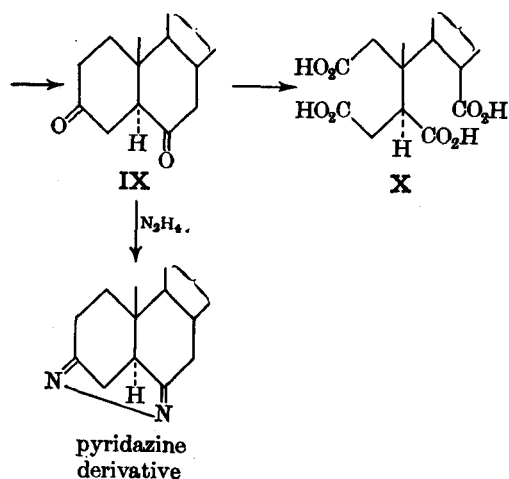

is in position 3 and the double bond between 5 and 6, position 5 being common to both rings A and B. Thus:

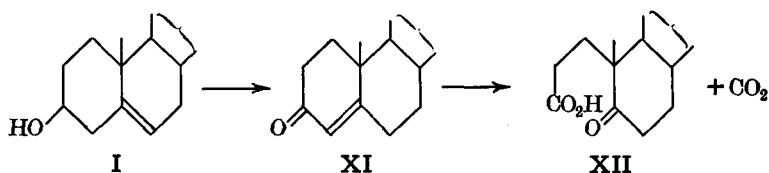

The position of the hydroxyl group at position 3 is definitely proved by the experiments of Kon *et al.* (1937, 1939). These authors reduced cholesterol, I, to cholestanol, II, oxidised this to cholestanone, III, treated this with methylmagnesium iodide and dehydrogenated the product, a tertiary alcohol, XIII, to 3':7-dimethylcyclopentenophenanthrene, XIV, by means of selenium. The structure of XIV was proved by synthesis, and so the reactions may be formulated as follows, with the hydroxyl at position 3.

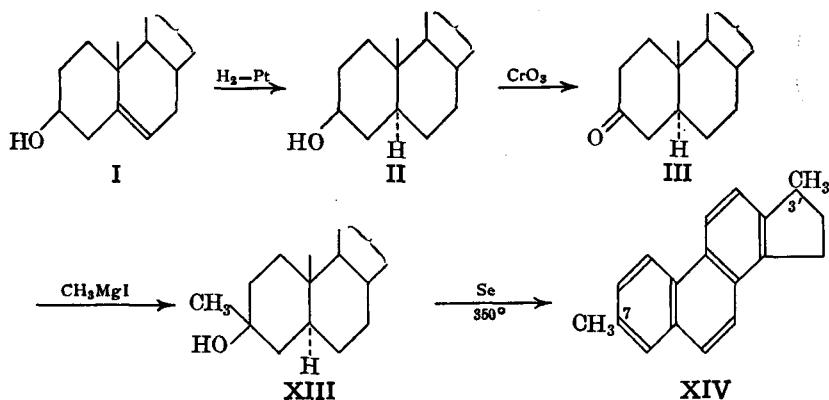

It might be noted here that the orientation of the two hydroxyl groups (introduced across the double bond in cholesterol) depends on the nature of the reagent used. With hydrogen peroxide, or *via* the oxide, the cholestanetriol is *trans*-5:6 (VII); with potassium permanganate or osmium

tetroxide, the product is *cis*-5 : 6 (VIIa; cf. §5a. IV). These orientations may be explained as follows. When the addition of the two hydroxyl groups occurs *via* the oxide (the 5 : 6-oxide), the oxide ring will be formed *behind* the plane of the molecule due to the steric effect of the methyl group. Since opening of the epoxide ring occurs by attack on the conjugate acid (§5a. IV), the water molecule will attack from the back of the ring (*i.e.*, from the *front* of the molecule), and also preferably at position 6 due to the steric effect of the methyl group. Thus the orientation of the two hydroxyl groups (*trans*) will be as shown in VII. With permanganate (and osmium tetroxide),

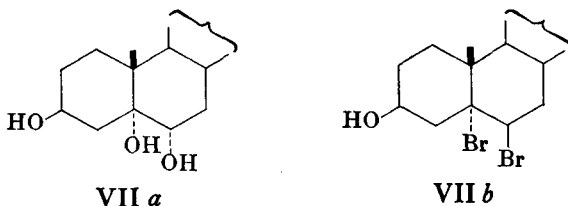

the plane of the cyclic compound will lie at the back of the molecule, again due to the steric effect of the methyl group. Moreover, since in the formation of the dihydroxy compound, *both* glycol oxygen atoms come from the permanganate ion (§5a. IV), it follows that *both* hydroxyl groups will be at the back of the molecule (VIIa).

The addition of bromine, occurring *via* a brominium ion (§5a. IV), will produce the dibromide VIIb, the reasons for the orientation being the same as those for the formation of VII (*via* the epoxide).

Since secondary alcoholic groups in steroids are readily oxidised to keto groups, and the latter may be located by mass spectra measurements (see §4b), this offers a very good way of locating secondary hydroxyl groups in the steroid molecule.

(iii) **Nature and position of the side-chain.** Acetylation of cholesterol produces cholesteryl acetate and this, on oxidation with chromium trioxide, forms a steam-volatile ketone and the acetate of a hydroxyketone (which is not steam volatile). The ketone was shown to be *isohexyl* methyl ketone,  $\text{CH}_3 \cdot \text{CO} \cdot (\text{CH}_2)_3 \cdot \text{CH}(\text{CH}_3)_2$ . Thus this ketone is the side-chain of cholesterol, the point of attachment of the side-chain being at the carbon of the keto group. These results do not show where the side-chain is attached to the nucleus of cholesterol, but if we accept that the position is at 17, then we may formulate the reactions as follows:

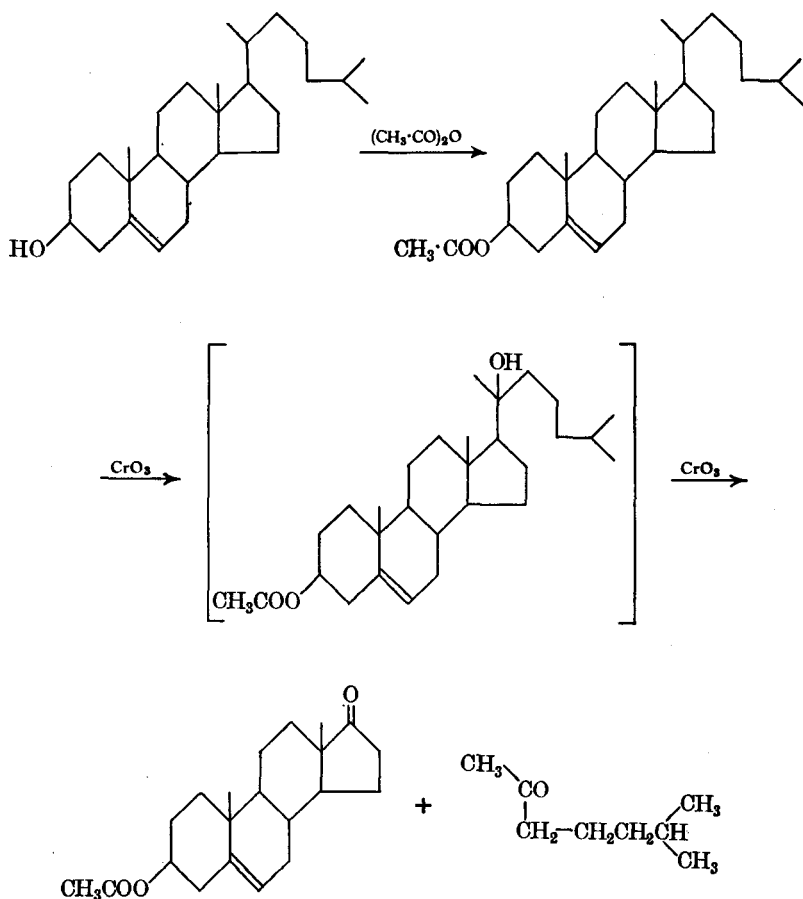

The nature of the side-chain has also been shown by the application of the Barbier-Wieland degradation. Since this method also leads to evidence that shows *which ring* of the nucleus is attached to the side-chain, we shall consider the problem of the nature of the side-chain again.

The Barbier-Wieland degradation offers a means of "stepping down" an acid one carbon atom at a time as follows:

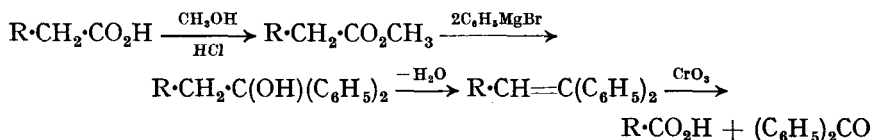

Methylmagnesium bromide may be used instead of phenylmagnesium bromide, and the alcohol so obtained may be directly oxidised:

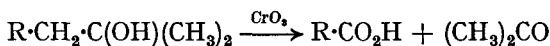

In the following account, only phenylmagnesium bromide will be used to demonstrate the application of the method to the steroids.

Cholesterol was first converted into coprostanone (a stereoisomer of cholesterol; see §§4, 4a). If we represent the nucleus of coprostanone as Ar, and

the side-chain as  $C_n$ , then we may formulate the degradation of coprostanone as follows (B-W represents a Barbier-Wieland degradation):

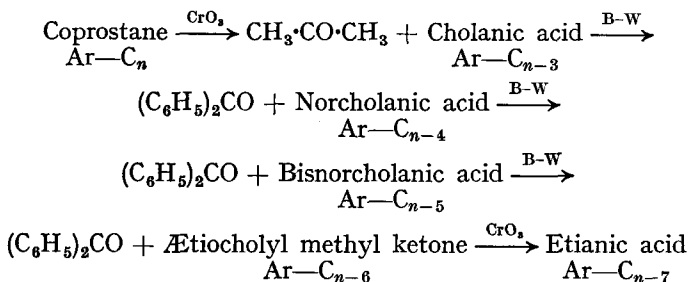

The formation of acetone from coprostanone indicates that the side-chain terminates in an *isopropyl* group. The conversion of bisnorcholanone into a ketone shows that there is an alkyl group on the  $\alpha$ -carbon atom in the former compound. Furthermore, since the ketone is oxidised to etianic acid (formerly known as *\text{\textbackslash}tiocholanone*) with the loss of one carbon atom, the ketone must be a methyl ketone, and so the alkyl group on the  $\alpha$ -carbon atom in bisnorcholanone is a methyl group.

Now the carboxyl group in etianic acid is directly attached to the nucleus; this is shown by the following fact. When etianic acid is subjected to one more Barbier-Wieland degradation, a ketone, *\text{\textbackslash}tiocholone*, is obtained and this, on oxidation with nitric acid, gives a dicarboxylic acid, *\text{\textbackslash}tiobilanic acid*, without loss of any carbon atoms. Thus *\text{\textbackslash}tiocholone* must be a cyclic ketone, and so it follows that there are *eight* carbon atoms in the side-chain, which must have the following structure in order to account for the foregoing degradations (see also the end of this section iii):

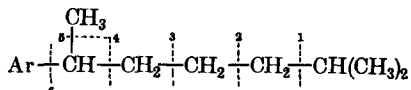

In addition to the Barbier-Wieland degradation, there are also more recent methods for degrading the side-chain:

(i) Gallagher *et al.* (1946) have introduced a method to eliminate *two* carbon atoms at a time:

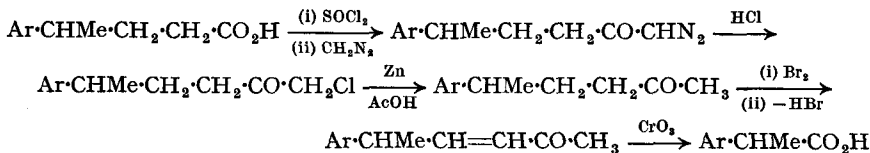

(ii) Miescher *et al.* (1944) have introduced a method to eliminate *three* carbon atoms at a time:

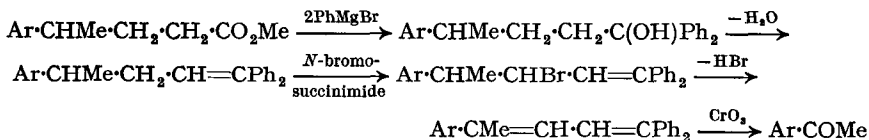

(iii) Jones *et al.* (1958) have carried out the fission of a steroid side-chain with an acid catalyst and have then subjected the volatile products to chromatography. This method has been used with as little as 30 mg. of material.



The problem now is: Where is the position of this side-chain? This is partly answered by the following observation. The dicarboxylic acid, ætiobilanic acid, forms an anhydride when heated with acetic anhydride. Thus the ketone (ætiocholanone) is probably a five-membered ring ketone (in accordance with Blanc's rule), and therefore the side-chain is attached to the five-membered ring D. The actual point of attachment to this ring, however, is not shown by this work. The formation of Diels' hydrocarbon (§1) from cholesterol suggests that the side-chain is at position 17, since selenium dehydrogenations may degrade a side-chain to a methyl group (see §2 vii. X). Position 17 is also supported by evidence obtained from X-ray photographs and surface film measurements. Finally, the following chemical evidence may be cited to show that the position of the side-chain is 17. As we have seen above, cholanic acid may be obtained by the oxidation of deoxycholic acid (a bile acid; see §8) followed by a Clemmensen reduction. Thus the side-chains in cholesterol and deoxycholic acid are in the same position. Now deoxycholic acid can also be converted into 12-ketocholanic acid which, on heating to 320°, loses water and carbon dioxide to form dehydronorcholene (Wieland *et al.*, 1930). This, when distilled with selenium, forms 20-methylcholanthrene, the structure of which is indicated by its oxidation to 5:6-dimethyl-1:2-benzanthraquinone which, in turn, gives on further oxidation, anthraquinone-1:2:5:6-tetracarboxylic acid (Cook, 1933). Finally, the structure of 20-methylcholanthrene has been confirmed by synthesis (Fieser *et al.*, 1935; see §3f. X). The foregoing facts can be explained only if the side-chain in cholesterol is in position 17; thus:

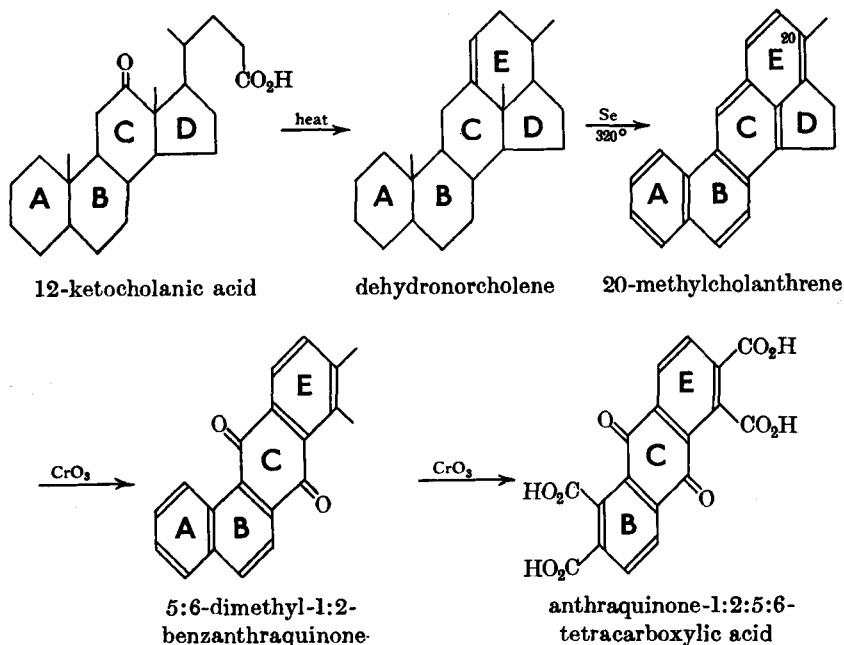

It should be noted that the isolation of methylcholanthrene affords additional evidence for the presence of the *cyclopentenophenanthrene* nucleus in cholesterol.

Thus, now that we know the nature and position of the side-chain, we can formulate the conversion of coprostanone into ætiobilanic acid as follows:

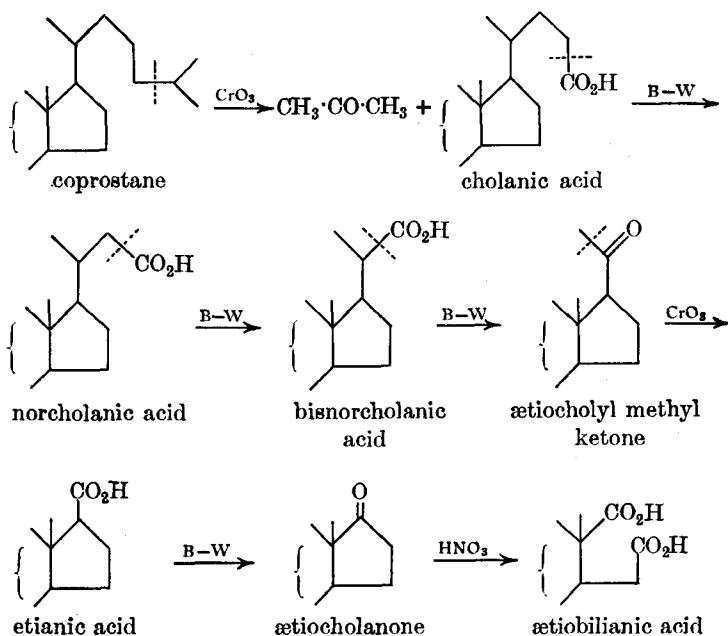

A point of interest in this connection is that when the anhydride of ætiobilanic acid is distilled with selenium, 1:2-dimethylphenanthrene is obtained (Butenandt *et al.*, 1933). This also provides proof for the presence of the phenanthrene nucleus in cholesterol, and also evidence for the position of the C<sub>13</sub> angular methyl group (see iv).

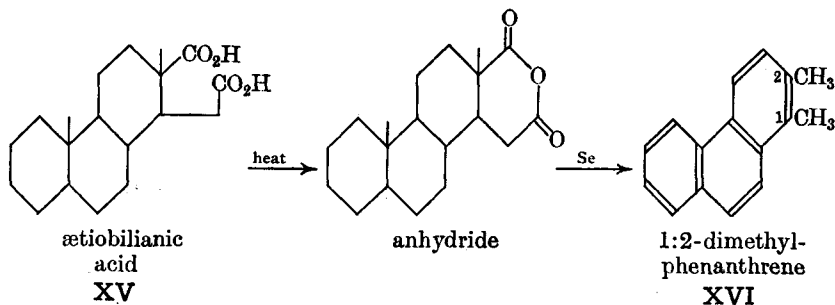

(iv) **Positions of the two angular methyl groups.** The cyclopenteno-phenanthrene nucleus of cholesterol accounts for seventeen carbon atoms, and the side-chain for eight. Thus twenty-five carbon atoms in all have been accounted for, but since the molecular formula of cholesterol is C<sub>27</sub>H<sub>46</sub>O, two more carbon atoms must be fitted into the structure. These two carbon atoms have been shown to be angular methyl groups.

In elucidating the positions of the hydroxyl group and double bond, one of the compounds obtained was the keto-acid XII. This compound, when subjected to the Clemmensen reduction and followed by two Barbier-Wieland degradations, gives an acid which is very difficult to esterify, and evolves carbon monoxide when warmed with concentrated sulphuric acid (Tschesche, 1932). Since these reactions are characteristic of an acid containing a carboxyl group attached to a tertiary carbon atom (*cf.* abietic acid, §31. VIII), the side-chain in XII must be of the type

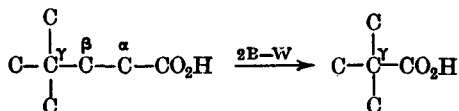

Thus there must be an alkyl group at position 10 in XII. This could be an ethyl group (as originally believed by Windaus and Wieland) or a methyl group, provided that in the latter case the second "missing" carbon atom can be accounted for. As we shall see later, there is also a methyl group at position 13, and so the alkyl group at position 10 must be a methyl group. On this basis, the degradation of XII may be formulated:

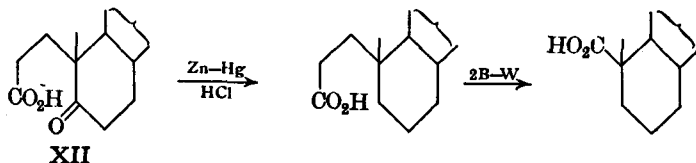

The position of the other angular methyl group is indicated by the following evidence. When cholesterol is distilled with selenium, chrysene is obtained as well as Diels' hydrocarbon (see §1). How, then, is the former produced if the latter is the ring skeleton of cholesterol? One possible explanation is that there is an angular methyl group at position 13, and on selenium dehydrogenation, this methyl group enters the five-membered ring D to form a six-membered ring; thus:

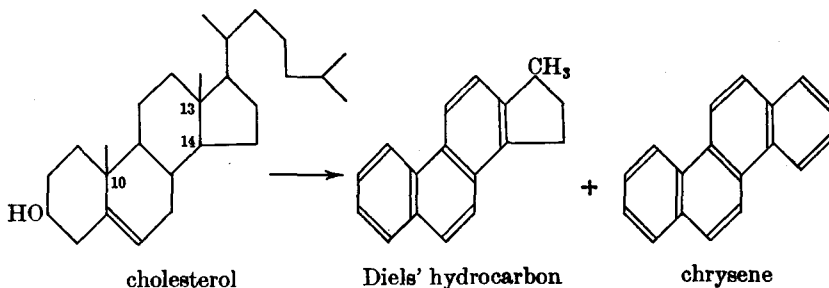

This evidence, however, is not conclusive, since ring expansion could have taken place had the angular methyl group been at position 14. Further support for the positions of the two angular methyl groups is given by the following degradative experiments (Wieland *et al.*, 1924, 1928, 1933) (see overleaf).

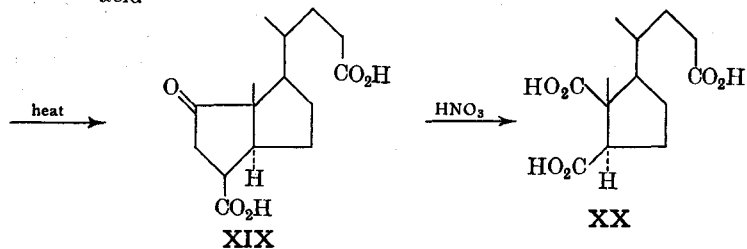
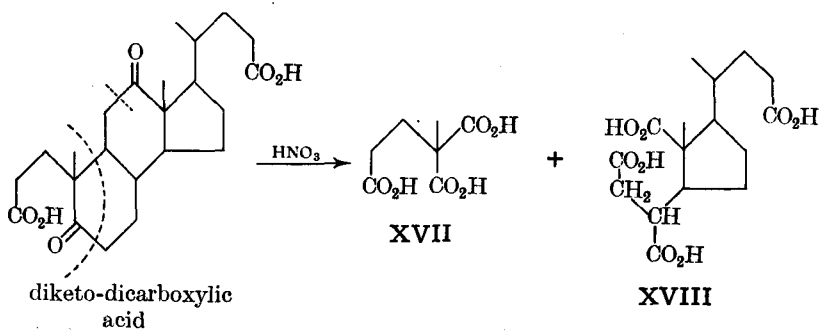
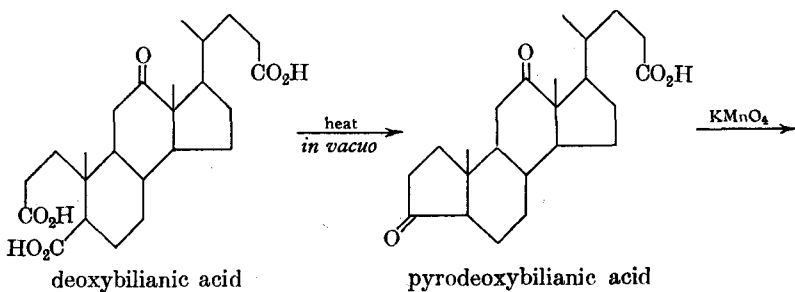
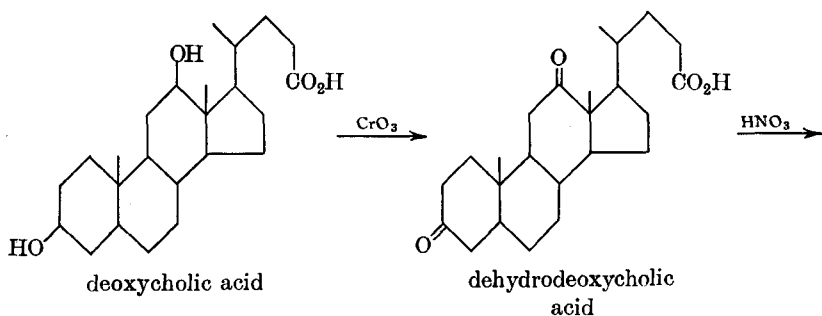

XVII was shown to be butane-2:2:4-tricarboxylic acid; thus there is a methyl group at position 10. XVIII was shown to be a tetracarboxylic acid containing a *cyclopentane* ring with a side-chain



Thus this compound is derived from ring D. XX was also shown to be a tricarboxylic acid containing a *cyclopentane* ring. Furthermore, one carb-

oxyl group in XX was shown to be attached to a tertiary carbon atom, and so it follows that there is a methyl group at 13 or 14. XX was then shown to have the *trans* configuration, *i.e.*, the two carboxyl groups are *trans*. Thus its precursor XIX must have its two rings in the *trans* configuration (the methyl group and hydrogen atom at the junction of the rings are thus *trans*). Theoretical considerations of the strain involved in the *cis*- and *trans*-forms of XIX suggest that the *cis*-form of XIX would have been obtained had the methyl group been at position 14. Thus the position of this angular methyl group appears (from this evidence) to be at 13, and this is supported by the fact that aetiobilanic acid (XV, section iii) gives 1 : 2-dimethylphenanthrene (XVI) on dehydrogenation with selenium. Had the angular methyl group been at position 14, 1-methylphenanthrene would most likely have been obtained.

(v) **Synthesis of cholesterol.** Two groups of workers, *viz.*, Sir R. Robinson *et al.* (1951) and Woodward *et al.* (1951), have synthesised cholesterol. One of the outstanding difficulties in the synthesis of steroids is the stereochemical problem. The cholesterol nucleus contains eight asymmetric carbon atoms and so 256 optical isomers are possible (see also §4 for further details). Thus every step in the synthesis which produced a new asymmetric carbon atom had to result in the formation of some (the more the better) of the desired stereoisomer, and at the same time resolution of racemic modifications also had to be practicable. Another difficulty was attacking a particular point in the molecule without affecting other parts. This problem led to the development of specific reagents. The following is an outline of the Woodward synthesis. 4-Methoxy-2 : 5-toluquinone, XXI, was prepared from 2-methoxy-*p*-cresol as follows:

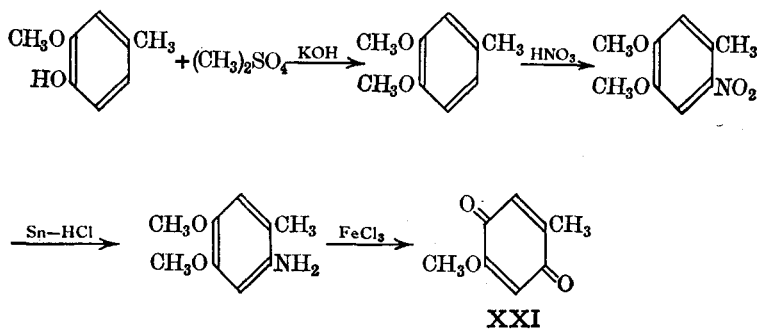

XXI was condensed with butadiene (Diels-Alder reaction) to give XXII. This had the *cis* configuration and was isomerised (quantitatively) to the *trans*-isomer XXIII by dissolving in aqueous alkali, adding a seed crystal of the *trans*-form, and then acidifying. XXIII, on reduction with lithium aluminium hydride, gave the glycol XXIV, and this, on treatment with aqueous acid, gave XXV. Conversion of XXV to XXVI by removal of the hydroxyl group was carried out by a new technique: XXV was acetylated and the product, the ketol acetate, was heated with zinc in acetic anhydride to give XXVI (reduction with metal and acid usually reduces  $\alpha$  :  $\beta$ -unsaturated bonds in ketones). XXVI, on treatment with ethyl formate in the presence of sodium methoxide, gave the hydroxymethylene ketone XXVII (Claisen condensation). When this was treated with ethyl vinyl ketone in the presence of potassium *tert.*-butoxide, XXVIII was formed (Michael condensation). The object of the double bond in the ketone ring in XXVI is to prevent formylation occurring on that side of the keto group, and the purpose of the formyl group is to produce an active methylene

group (this is now flanked on *both* sides by carbonyl groups). The necessity for this "activation" lies in the fact that ethyl vinyl ketone tends to self-condense, and consequently decrease the yield of XXVIII. XXVIII was now cyclised (quantitatively) by means of potassium hydroxide in aqueous dioxan to the single product XXIX. This is the desired compound; the other possible isomer (XXIX with the two hydrogens *cis* instead of *trans* as shown) is not formed since the *cis*-isomer is less stable than the *trans*-. XXIX was then treated with osmium tetroxide to give two *cis*-glycols of structure XXX. These were separated, and the desired isomer (the one insoluble in benzene) was treated with acetone in the presence of anhydrous copper sulphate to give the *isopropylidene* derivative XXXI. This, on catalytic reduction ( $H_2$ -Pd/SrCO<sub>3</sub>) gave XXXII which was condensed with ethyl formate in the presence of sodium methoxide to give XXXIII, and this was then converted into XXXIV by means of methylaniline. The purpose of this treatment was to block undesired condensation reactions on this side of the keto group (at this position 3). When XXXIV was condensed with vinyl cyanide (cyanoethylation) and the product hydrolysed with alkali, the product was a mixture of two keto acids. These were separated and the stereoisomer XXXV (methyl group in front and propionic acid group behind the plane of the rings) was converted into the enol lactone XXXVI which, on treatment with methylmagnesium bromide, gave XXXVII, and this, on ring closure by means of alkali, gave XXXVIII. When this was oxidised with periodic acid in aqueous dioxan, the dialdehyde XXXIX was obtained, and this, when heated in benzene solution in the presence of a small amount of piperidine acetate, gave XL (and a small amount of an isomer). This ketoaldehyde was oxidised to the corresponding acid which was then converted into the methyl ester XLI with diazomethane. XLI, a racemate, was resolved by reduction of the keto group with sodium borohydride to the hydroxy esters [(±)-3 $\alpha$ - and (±)-3 $\beta$ -]. The (+)-form of the 3 $\beta$ -alcohol was preferentially precipitated by digitonin, and this stereoisomer was now oxidised (Oppenauer oxidation) to give the desired stereoisomer (+)-XLI. This was catalytically reduced ( $H_2$ -Pt) to XLII, which was then oxidised to XLIII which was a mixture of stereoisomers (from the mixture of XLII; H at 17 behind and in front). These were separated, reduced (sodium borohydride), and hydrolysed. The  $\beta$ -isomer, XLIV, was converted into the methyl ketone by first acetylating, then treating with thionyl chloride and finally with dimethylcadmium. This acetylated hydroxyketone, XLV, on treatment with *isohexylmagnesium* bromide, gave XLVI. This was a mixture of isomers (a new asymmetric carbon has been introduced at position 20). XLVI, on dehydration, gave one product, XLVII, and this, on catalytic hydrogenation ( $H_2$ -Pt), gave a mixture of cholestanyl acetates (the asymmetric C<sub>20</sub> has been re-introduced). These acetates were separated and the desired isomer, on hydrolysis, gave cholestanol, XLVIII, which was identical with natural cholestanol. The conversion of cholestanol into cholesterol, LIII, is then carried out by a series of reactions introduced by various workers: XLVIII to XLIX (Bruce, 1943); XLIX to L (Butenandt *et al.*, 1935); L to LI (Ruzicka, 1938); LI to LII (Westphal, 1937); LII to LIII (Dauben *et al.*, 1950).

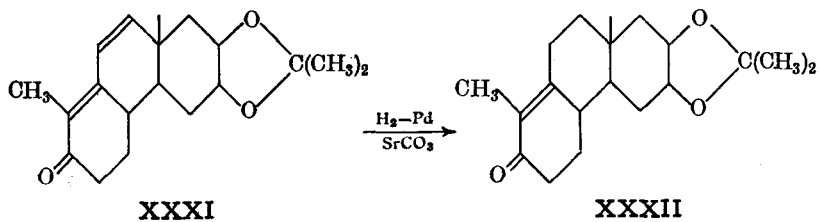
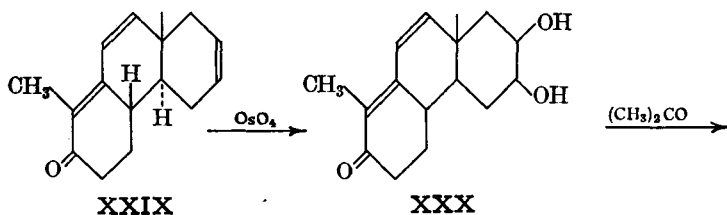
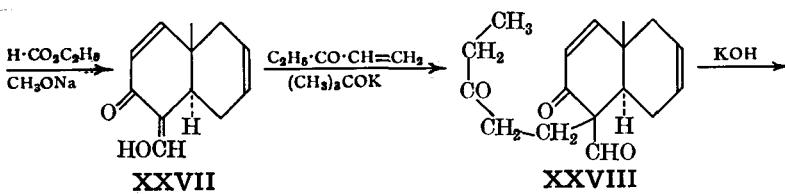
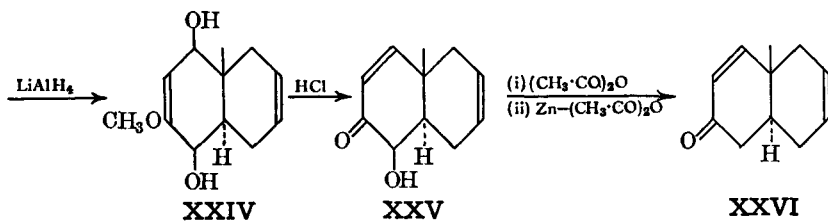
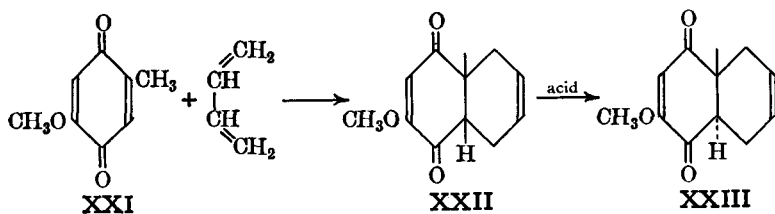

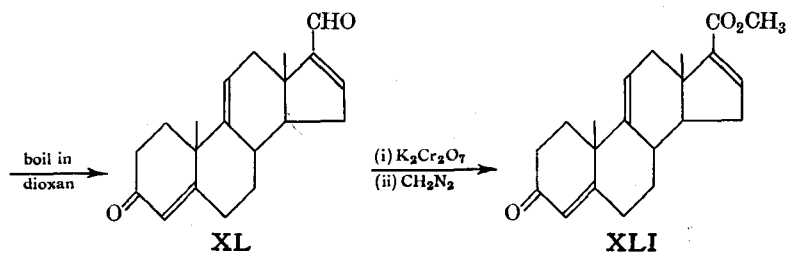
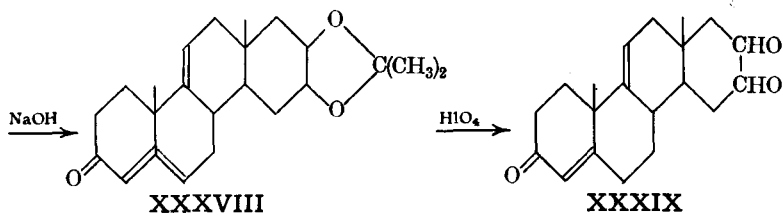
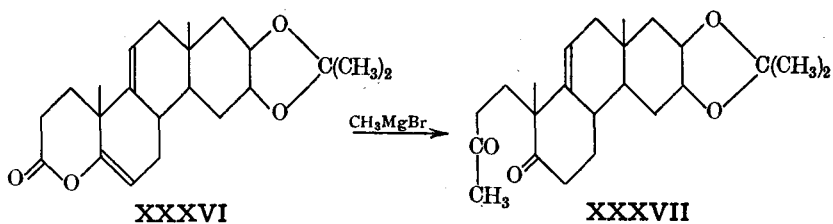
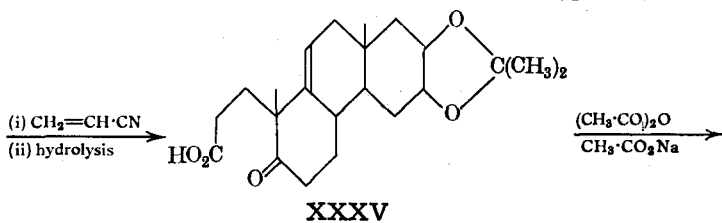
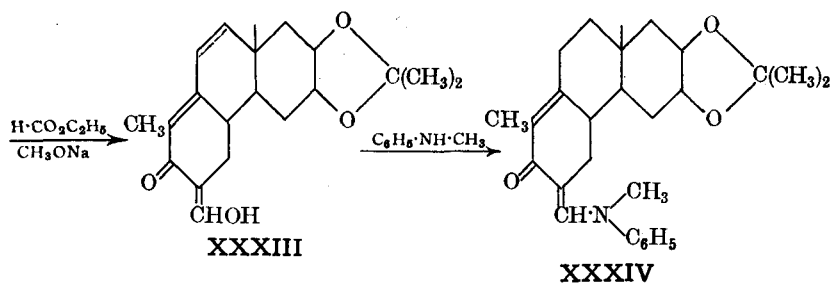



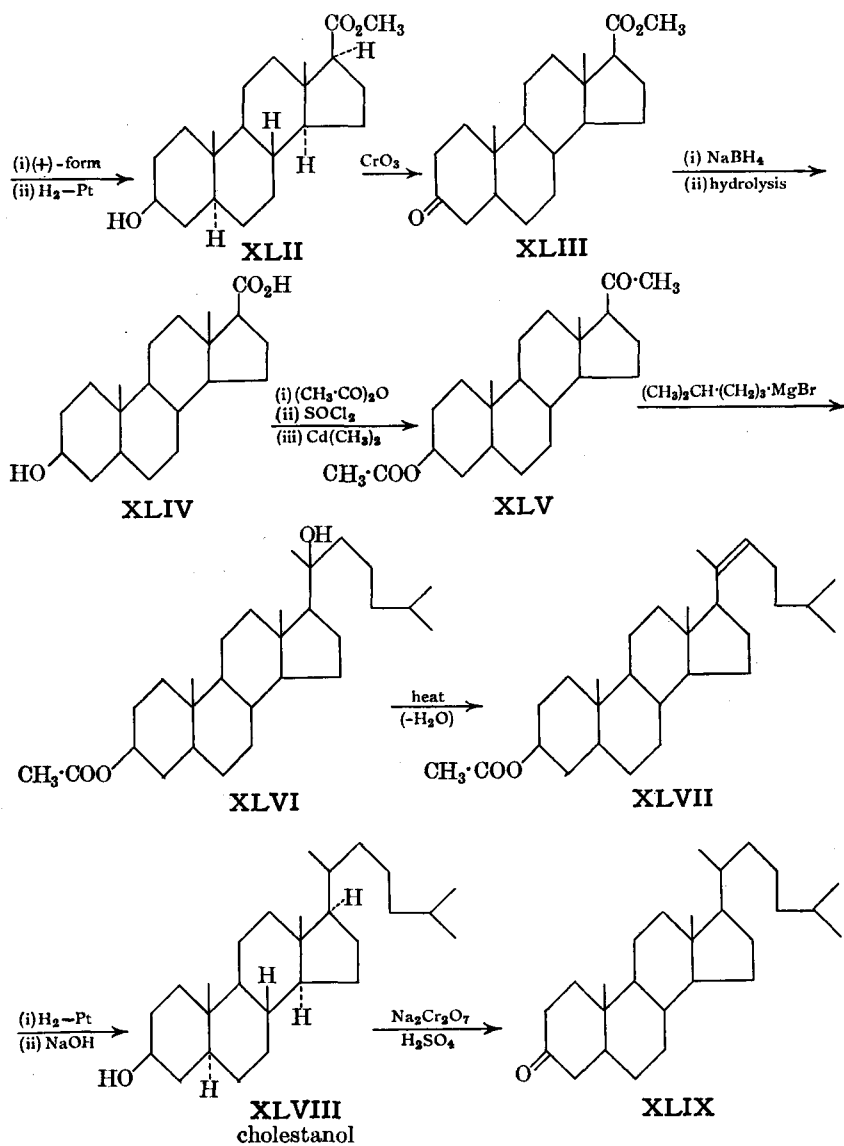

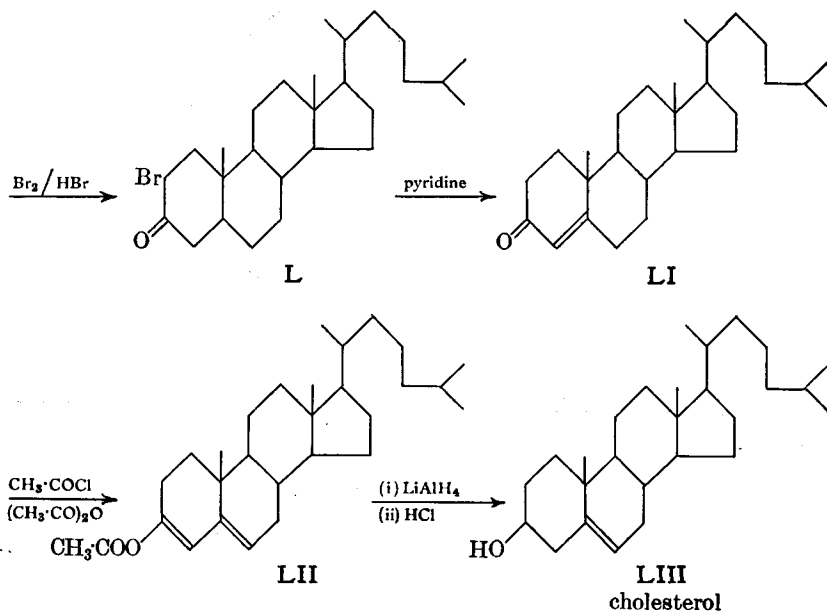

**§4. Stereochemistry of the steroids.** If we examine the fully saturated sterol, we find that there are eight dissimilar asymmetric carbon atoms in the nucleus (3, 5, 8, 9, 10, 13, 14 and 17). Thus there are  $2^8 = 256$  optical isomers possible. If we also include the asymmetric carbon atom in the side-chain (20), then there are 512 optical isomers possible.

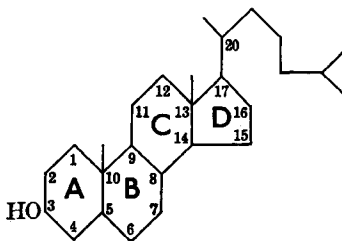

The stereoisomerism of the steroids is conveniently classified into two types, one dealing with the way in which the rings are fused together, and the other with the configurations of substituent groups, particularly those at  $\text{C}_3$  and  $\text{C}_{17}$ .

**§4a. Configuration of the nucleus.** There are six asymmetric carbon atoms in the nucleus (5, 8, 9, 10, 13 and 14), and therefore there are  $2^6 = 64$  optically active forms possible. X-ray analysis has shown that the steroid molecule is long and *thin*, *i.e.*, the molecule is essentially *flat* (Bernal, 1932). This is only possible if rings B and C are fused together in a *trans* manner (*cf.* *trans*-decalin, §11 vii. IV); rings A/B and C/D could be *cis* or *trans*. It has been found that all naturally occurring saturated steroids, except those of the heart poisons, belong either to the *cholestane series* or to the *coprostane series*; in the former the rings A/B are *trans*, and in the latter *cis*, the rings B/C and C/D being *trans* in *both* series. By convention a full line represents groups above the plane of the molecule, and a dotted (or broken) line represents groups below the plane (see also §11 vii. IV for

conventions). Furthermore, *by convention*, the methyl group at  $C_{10}$  in *cholestane* has been placed *above* the plane of the molecule, and therefore this leads to *four* possible stereoisomers for cholestane (I-IV). X-ray

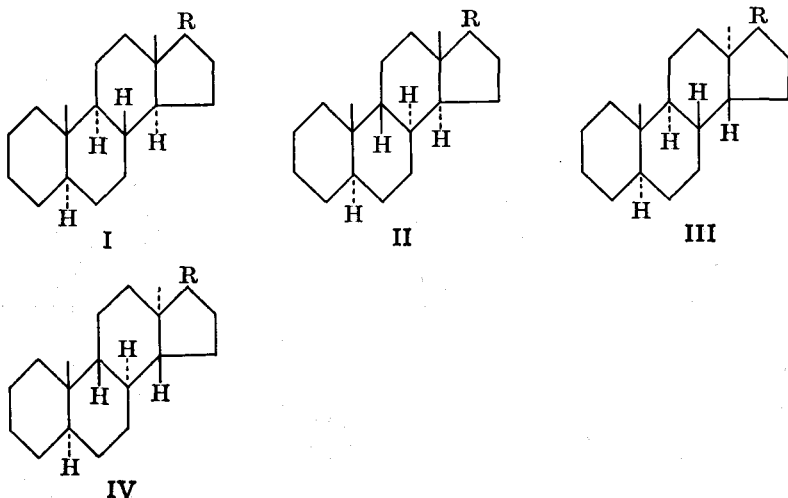

analysis has shown that the hydrogen atom at  $C_9$  is *trans* to the methyl group at  $C_{10}$  (Bernal *et al.*, 1940), and this conclusion is supported by chemical evidence. Thus cholestane must be I or III. Further chemical work has shown that the methyl groups at  $C_{10}$  and  $C_{13}$  are *cis*, and so cholestane is I, and consequently coprostane is also I, except that in this case the hydrogen atom at  $C_5$  is *above* the plane (rings A/B are *cis* in coprostane). The final point to be settled in connection with this problem of the configuration of cholestane is the orientation of the side-chain R at  $C_{17}$ . Chemical evidence and X-ray analysis studies have shown that this side-chain is *above* the plane of the molecule (*i.e.*, *cis* with respect to the two angular methyl groups). Thus cholestane and coprostane are:

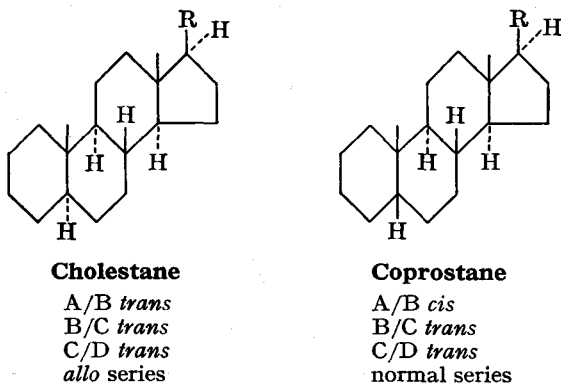

Compounds derived from cholestane are known as the ***allo*-compounds**, the prefix *allo* being reserved to indicate this configuration at  $C_5$ . Compounds derived from coprostane are known as the ***normal*-compounds**, but it should be noted that it is not customary to prefix compounds of this series by the word *normal*, *e.g.*, *allocholan*ic acid can be derived from cholestane, whereas *cholan*ic acid can be derived from coprostane.

**§4b. Configurations of substituent groups.** The configuration of the side-chain at  $C_{17}$  has already been mentioned above. The only other configuration that we shall discuss here is that of the hydroxyl group at  $C_3$ . By convention, the hydroxyl at  $C_3$  in **cholestanol** (and cholesterol) is taken as being **above** the plane of the ring, *i.e.*, the hydroxyl group is taken as being in the *cis* position with respect to the methyl group at  $C_{10}$ . This configuration occurs in all *natural* sterols, and gives rise to the  **$\beta$ -series**, the prefix  $\beta$  always indicating that the substituent group lies *above* the plane of the molecule. When the hydroxyl group lies **below** the plane, the compounds are said to belong to the  **$\alpha$ - or epi series**; the prefix epi indicates the *epimer* due to the inversion of the configuration of  $C_3$ .

X-ray analysis studies have shown that the hydroxyl group in cholesterol is above the plane of the molecule, *i.e.*, it is *cis* to the methyl group at  $C_{10}$ . This has been confirmed by chemical evidence (Shoppee, 1947).

The assignment of the configurations of  $C_7$  and  $C_{17}$  in steroid alcohols has been determined by Prelog *et al.* (1953) by arguments based on asymmetric syntheses (see §7. III). It has been shown that the configuration of the hydroxyl group in, *e.g.*, cholestan-7 $\alpha$ -ol and androsten-17 $\beta$ -ol is in agreement with the accepted conventional steroid formula.

Mills (1952) has also correlated the configurations of steroids with glyceraldehyde. This author collected the molecular optical rotations of a number of pairs of epimeric *cyclohex-2-enols* and their esters, and on the assumption that the configurations given (in the literature) were correct, Mills showed that the alcohol represented as I is more *l*ævorotatory than its epimer II, irrespective of the positions of alkyl groups in these allylic terpene alcohols (these compounds had already been correlated with glyceraldehyde by the work of Fredga; §23e. VIII). The differences in rotation are large, and are increased on esterification. Mills then applied this rule to seven known

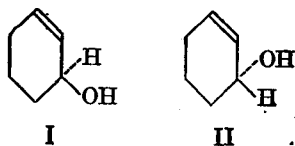

pairs of epimeric, allylic steroid alcohols, and found that the differences were those which may be predicted on the basis that the conventional steroid formulæ represent the absolute configurations. Thus the configuration of the  $3\beta$ -hydroxyl group in cholesterol corresponds to that of *D*(+)-glyceraldehyde.

These stereochemical relationships of steroids to *D*(+)-glyceraldehyde have now been proved by the degradation of cholesterol to derivatives of (+)-citronellal (§23e. VIII), in which the only asymmetric carbon atom is the  $C_{20}$  of the steroid (Cornforth *et al.*, 1954; Riniker *et al.*, 1954). Thus the arbitrary choice of placing the angular methyl groups above the plane in the cholesterol nucleus (*i.e.*, the  $\beta$ -configuration) has proved to be the absolute configuration. Furthermore, since the configuration of the 3-hydroxyl group in cholesterol is  $\beta$ , this configuration is also the absolute one.

Barton (1944-) has also applied the method of optical rotations to steroid chemistry, and has called his treatment the Method of Molecular Rotation Differences (this is a modification of the Rule of Shift, §12. I). The basis of this method is that the molecular rotation of any steroid is considered as the sum of the rotation of the fundamental structure (which is the parent hydrocarbon cholestane, androstane, or pregnane) and the rotations contributed by the functional groups (these are called the  $\Delta$  values). The  $\Delta$

value of a given group is a characteristic of its position and orientation, and the  $\Delta$  values of different groups are independent of one another provided that unsaturated groups are not present, *i.e.*, conjugation is absent, or that the groups are not too close together, *i.e.*, are separated by 3 or 4 saturated carbon atoms. In this way it has been possible to assign configurations and also the positions of double bonds.

Correlation of configurations in steroids has also been carried out by the method of rotatory dispersion (§12a. I). Saturated steroids have been examined (Djerassi *et al.*, 1956) and the results show that as the position of the carbonyl group changes in A/B *trans*-steroids, the curves change in sign, shape and/or amplitude. Thus this method may be used to locate the unknown position of a carbonyl group in a steroid. The authors also showed that for a *given* position of the carbonyl group, the shape of the curve depends on the conformation of the molecule. Thus, by comparing the curve of the compound under investigation with that of a compound of *known* absolute configuration and containing the carbonyl group in the *same* position, it is then possible to deduce the absolute configuration of a group in the unknown compound.

On the other hand, Djerassi *et al.* (1962) have shown that mass spectra measurements of keto steroids offer a means of *locating* the carbonyl group in a steroid molecule. However, when mass spectrometry is combined with optical rotatory dispersion measurements, it is then possible to locate in an unambiguous manner the carbonyl group.

**§4c. The preparation of the "stanols".** The catalytic hydrogenation (platinum) of cholesterol (cholest-5-en-3 $\beta$ -ol) produces only cholestanol (cholestan-3 $\beta$ -ol). On the other hand, oxidation of cholestanol with chromium trioxide in acetic acid gives cholestanone and this, on catalytic reduction in *neutral* solution, gives mainly cholestanol, whereas catalytic reduction in *acid* solution gives mainly epicholestanol (cholestan-3 $\alpha$ -ol).

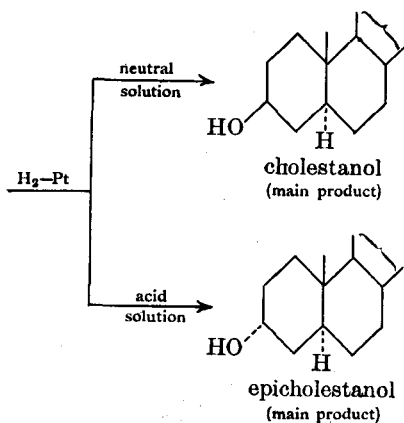
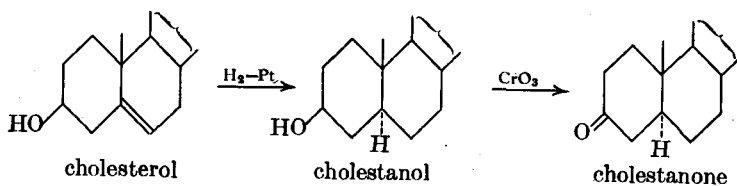

The corresponding  $C_5$  epimers, coprostanol (coprostan- $3\beta$ -ol) and epicoprostanol (coprostan- $3\alpha$ -ol), may be prepared from cholesterol as follows, the first step being the conversion of cholesterol into cholest-4-en-3-one by means of the Oppenauer oxidation (aluminium *tert.*-butoxide in acetone; see also Vol. I).

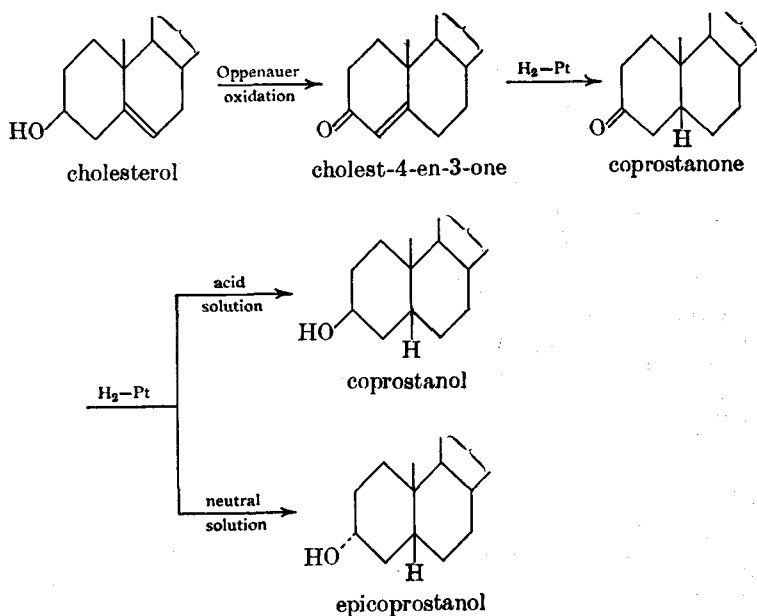

A detailed study of the catalytic reduction of the decalones has shown that in an acid medium the product is usually the *cis*-compound, whereas in a neutral or alkaline medium the product is usually the *trans*-compound (von Auwers, 1920; Skita, 1920). This principle, which is known as the *Auwers-Skita rule of catalytic hydrogenation*, was used by Ruzicka (1934) to determine the configurations of the above "stanols". The configurations assigned have been supported by measurement of the rates of hydrolysis of the acetates of the various "stanols" (Ruzicka *et al.*, 1938). The acetates of cholestanol and epicoprostanol are hydrolysed much faster than those of epicholestanol and coprostanol (see §4d).

A point of interest in connection with the Auwers-Skita rule is that this generalisation does not allow for the possibility of isomerisation. Schuetz *et al.* (1962) have shown that in the hydrogenation of the three xylenes, the yield of the *trans*-isomer increased with temperature.

Now let us consider the configuration at  $C_5$ . The results of experiments on the catalytic hydrogenation of substituted *cyclohexanones* and substituted phenols have led to the generalisation that the initial addition is *cis*, and occurs on the more accessible side of the double bond (Peppiatt *et al.*, 1955; Wicker, 1956). In accordance with this generalisation, it has been found that when saturated steroids of the A/B-*cis*- and the A/B-*trans*-series are produced by catalytic hydrogenation of  $3\alpha$ -substituted  $\Delta^5$ -steroids, then the larger the size of the  $3\alpha$ -substituent, the larger is the proportion of the A/B-*cis*-steroid; in some cases, this *cis*-steroid is apparently formed exclusively (Shoppee *et al.*, 1955).

**§4d. Conformational analysis of steroids.** The Auwers-Skita rule of catalytic hydrogenation (§4c) cannot be used with certainty since, as pointed

out, the product is *usually* mainly *cis* or *trans* according to the conditions, and hence the exceptions can only be ascertained as such by other evidence. Barton (1953) has restated this Auwers-Skita rule of catalytic hydrogenation as follows: Catalytic hydrogenation of ketones in strongly acid media (rapid hydrogenation) produces the axial hydroxyl compound, whereas hydrogenation in neutral media (slow hydrogenation) produces the equatorial alcohol if the ketone is unhindered or the axial alcohol if the ketone is very much hindered.

All the evidence obtained has shown that all the *cyclohexane* rings in the steroid nucleus are chair forms; thus I is cholestane, and II is coprostanane.

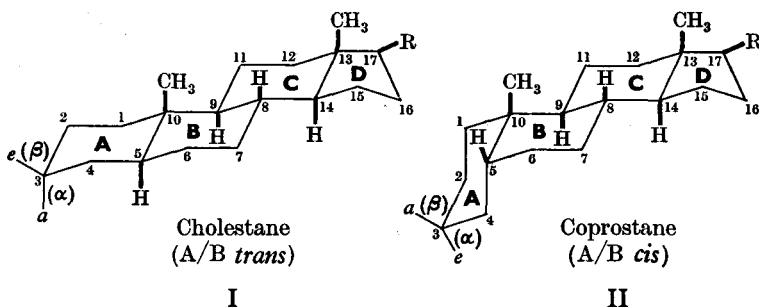

The effect of conformation on the course and rate of reactions has been discussed in §12. IV. The following is a summary of the generalisations that have been formulated:

(i) Equatorial groups are normally more stable than axial. Thus, when a (polycyclic) secondary alcohol is equilibrated with alkali, it is the equatorial isomer that predominates in the product. Similarly, when a (polycyclic) ketone is reduced with sodium and ethanol, the predominant isomer in the product is the equatorial alcohol (the more stable form). Furthermore, because of the rigidity of the system (which prevents interconversion of chair forms), the stable configurations of hydroxyl groups at different positions in the cholestane series will be as shown in III (compare this with I).

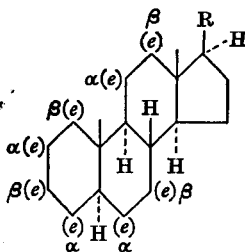

III

The following are examples of equilibration (using sodium ethoxide at 180°) (see also §8. II):



(ii) Equatorial hydroxyl and carboxyl groups are esterified more rapidly

than the corresponding axial groups. Similarly, hydrolysis of equatorial esters and acyloxy groups is more rapid than for the corresponding axial isomers. These principles explain Ruzicka's results on the "stanols" (§4c); in the acetates of cholestanol and epicoprostanol, the acetoxy groups are equatorial, whereas in the acetates of epicholestanol and coprostanol these groups are axial and therefore subject to 1:3-interactions. Hence the former pair are hydrolysed more rapidly than the latter pair.

Empirical methods, using infra-red spectra, have been developed by Jones *et al.* (1951, 1952) for determining the conformation of 3-hydroxy (and 3-acetoxy) steroids; characteristic bands are given by the axial and equatorial groups.

(iii) Secondary axial alcohols are more rapidly oxidised by chromic acid (or hypobromous acid) than secondary equatorial alcohols. Schreiber *et al.* (1955) have shown that the more hindered the alcohol, the faster is the oxidation (with chromic acid).

(iv) Bimolecular ionic elimination reactions occur readily when the two groups (which are eliminated) are *trans*-diaxial, and less readily when *trans*-diequatorial or *cis*-axial:equatorial.

(v) Epoxides are attacked by, *e.g.*, hydrogen bromide, to give the *trans*-diaxial compound. Reduction with lithium aluminium hydride or catalytic hydrogenation converts epoxides into the axial hydroxy compound.

§5. **Ergosterol**,  $C_{28}H_{44}O$ , m.p.  $163^\circ$ , occurs in yeast. Ergosterol forms esters, *e.g.*, an acetate with acetic anhydride; thus there is a hydroxyl group present in ergosterol. Catalytic hydrogenation (platinum) of ergosterol produces ergostanol,  $C_{28}H_{50}O$ ; thus there are three double bonds in ergosterol. When ergostanol is acetylated and the product then oxidised, the acetate of  $3\beta$ -hydroxynorallocholanolic acid, I, is obtained (Fernholz *et al.*, 1934). The identity of I is established by the fact that cholestanyl acetate, II (a compound of known structure), gives, on oxidation, the acetate of  $3\beta$ -hydroxyallocholanolic acid, III, and this, after one Barbier-Wieland degradation (§3 iii), gives I; thus:

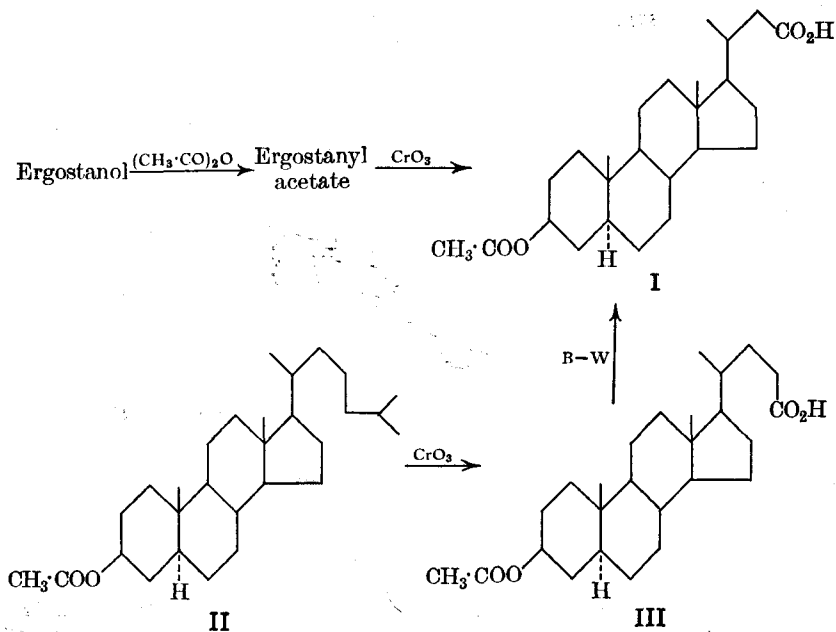



Thus ergosterol and cholestanol have identical nuclei, the same position of the hydroxyl group and the same position of the side-chain. The only difference must be the *nature* of the side-chain, and hence it follows that ergosterol contains one more carbon atom in its side-chain than cholesterol (the former compound is  $C_{28}H_{44}O$  and the latter  $C_{27}H_{46}O$ ). Ozonolysis of ergosterol gives, among other products, methylisopropylacetaldehyde, IV. This can be accounted for if the side-chain of ergosterol is as shown in V (Windaus *et al.*, 1932).

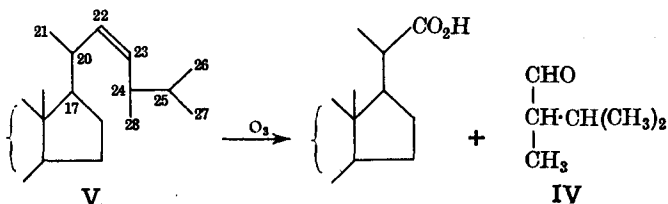

On this basis, the oxidation of ergostanyl acetate to the acetate of 3 $\beta$ -hydroxynorallocholanic acid, I, is readily explained.

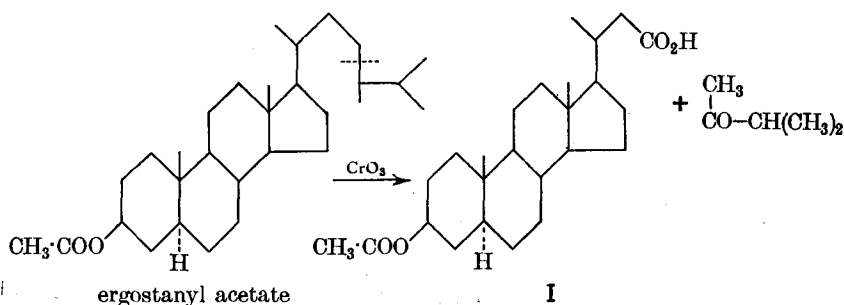

We have now accounted for all the structural features of ergosterol except the positions of the three double bonds. The position of one of these is actually shown in the above account; it is  $C_{22}-C_{23}$ . The side-chain must contain only *one* double bond, since if more than one were present, more than one fragment (IV) would have been removed on ozonolysis. Thus the other two double bonds must be in the nucleus. When heated with maleic anhydride at  $135^\circ$ , ergosterol forms an adduct, and so it follows that the two double bonds (in the nucleus) are conjugated (Windaus *et al.*, 1931). Now ergosterol has an absorption maximum at 2810 A. Conjugated *acyclic* dienes absorb in the region of 2200–2500 A, but if the diene is in a *ring system*, then the absorption is shifted to the region 2600–2900 A. Thus the two double bonds in the nucleus of ergosterol are in *one* of the rings (Dimroth *et al.*, 1936). When ergosterol is subjected to the Oppenauer oxidation (aluminium *tert.*-butoxide and acetone), the product is an  $\alpha : \beta$ -unsaturated ketone (as shown from its absorption spectrum). This can only be explained by assuming that one of the double bonds is in the 5 : 6-position, and moves to the 4 : 5-position during the oxidation (*cf.* cholesterol, §3 ii). The other double bond is therefore 7 : 8 in order to be conjugated with the one that is 5 : 6. Thus the conjugated system is in ring B and the oxidation is explained as follows:

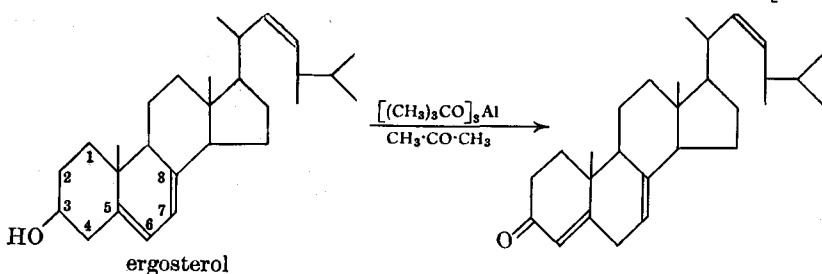

**§6. Vitamin D.** This vitamin is the antirachitic vitamin; it is essential for bone formation, its function being the control of calcium and phosphorus metabolism.

Steenbock *et al.* (1924) showed that when various foods were irradiated with ultraviolet light, they acquired antirachitic properties. This was then followed by the discovery that the active compound was in the unsaponifiable fraction (the sterol fraction). At first, it was believed that the precursor of the active compound was cholesterol, but subsequently the precursor was shown to be some "impurity" that was in the cholesterol fraction (*e.g.*, by Heilbron *et al.*, 1926). The ultraviolet absorption spectrum of this "impure cholesterol" indicated the presence of a small amount of some substance that was more unsaturated than cholesterol. This led to the suggestion that ergosterol was the provitamin D in the "impure cholesterol", and the investigation of the effect of ultraviolet light on ergosterol resulted in the isolation from the irradiated product of a compound which had very strong antirachitic properties. This compound was named **calciferol** by the Medical Research Council (1931), and **vitamin D<sub>1</sub>** by Windaus (1931). This potent crystalline compound, however, was subsequently shown to be a molecular compound of calciferol and lumisterol (one molecule of each). Windaus (1932) therefore renamed the pure potent compound as **vitamin D<sub>2</sub>**, but the M.R.C. retained the original name calciferol. The *Chemical Society* (1951) has proposed the name **ergocalciferol** for this pure compound.

A detailed study of the irradiation of ergosterol with ultraviolet light has led to the proposal that the series of changes is as follows ( $R = C_9H_{17}$ ):

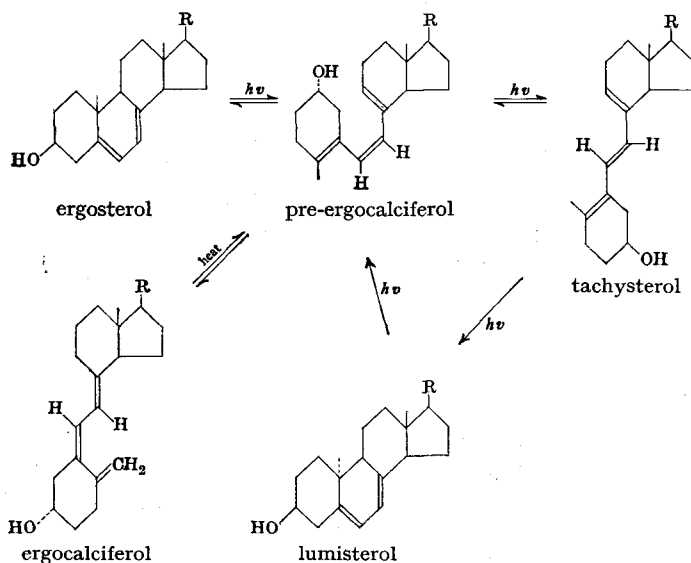

Velluz *et al.* (1949) isolated the pre-ergocalciferol (P) by irradiation of ergosterol at 20°, and showed that it formed ergocalciferol (E) on heating (see also below). Velluz *et al.* (1955) and Havinga *et al.* (1955) showed that pre-ergocalciferol is the 6:7-*cis*-isomer of tachysterol (T), and the inter-conversion of these two compounds has been studied by Inhoffen *et al.* (1959) and Havinga *et al.* (1959). Lumisterol (L) is converted directly into pre-ergocalciferol (Rappoldt, 1960). It should be noted that tachysterol and lumisterol are formed in a side reaction from pre-ergocalciferol and are *not* directly involved in the formation of ergocalciferol as postulated in the original scheme of Windaus *et al.*, who carried out the irradiation in solution and allowed the temperature to rise to 50°:

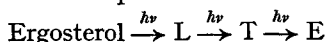

§6a. **Ergocalciferol** (calciferol, vitamin D<sub>2</sub>) is an optically active crystalline solid, m.p. 115–117°. Its molecular formula is C<sub>28</sub>H<sub>44</sub>O, and since it forms esters, the oxygen is present as a hydroxyl group. Furthermore, since ergocalciferol gives a ketone on oxidation, this hydroxyl group is a secondary alcoholic group. Ozonolysis of ergocalciferol produces, among other products, methylisopropylacetaldehyde. Thus the side-chain in ergocalciferol is the same as that in ergosterol. Catalytic hydrogenation converts ergocalciferol into the fully saturated compound octahydroergocalciferol, C<sub>28</sub>H<sub>52</sub>O. This shows that there are four double bonds present, and since one is in the side-chain, three are therefore in the nucleus. The parent hydrocarbon of ergocalciferol is C<sub>28</sub>H<sub>52</sub>, and since this corresponds to the general formula C<sub>n</sub>H<sub>2n-4</sub>, the molecule therefore is *tricyclic*. Furthermore, ergocalciferol does not give Diels' hydrocarbon when distilled with selenium. These facts indicate that ergocalciferol does not contain the four-ring system of ergosterol. The problem is thus to ascertain which of the rings in ergosterol has been opened in the formation of ergocalciferol. The following reactions of ergocalciferol are readily explained on the assumption that its structure is I. The absorption spectrum of the semicarbazone of II (C<sub>21</sub>H<sub>34</sub>O) was shown to be characteristic of α:β-unsaturated aldehydes. The absence of the hydroxyl group and the carbon content of II indicate the *absence* of ring A. These facts suggest that in ergocalciferol "ring B" is open between C<sub>9</sub> and C<sub>10</sub>, and that II arises by scission of the molecule at a double bond in position 5:6, and can be an α:β-unsaturated aldehyde only if there is a double bond at 7:8 (these double bonds are also present in ergosterol). The isolation of the ketone III (C<sub>19</sub>H<sub>32</sub>O) confirms the presence of the double bond at 7:8 (Heilbron *et al.*, 1935).

The isolation of formaldehyde (IV) shows the presence of an exocyclic methylene group, and the presence of this group at C<sub>10</sub> is in keeping with the opening of ring B at 9:10. The formation of V (C<sub>13</sub>H<sub>20</sub>O<sub>3</sub>), a keto-acid, suggests that ring B is open at 9:10, and that there are two double bonds at 7:8 and 22:23. The position of the latter double bond is confirmed by the isolation of methylisopropylacetaldehyde, VI (Heilbron *et al.*, 1936).

Structure I for ergocalciferol is also supported by the formation of VII, the structure of which is shown by the products VIII, IX, X and XI (Windaus *et al.*, 1936). The production of 2:3-dimethylnaphthalene (VIII) is in keeping with the fact that carboxyl groups sometimes give rise to methyl groups on selenium dehydrogenation (*cf.* §2 vii. X). Similarly, the formation of naphthalene, IX, and naphthalene-2-carboxylic acid, X, shows the presence of rings A and "B" in VII. Catalytic reduction of VII (to reduce the double bond in the *side-chain* only), followed by ozonolysis, gives XI. Thus the formation of these compounds VIII–XI establishes the structure of VII, and shows that the double bonds are at 5:6, 10:19 and 7:8.

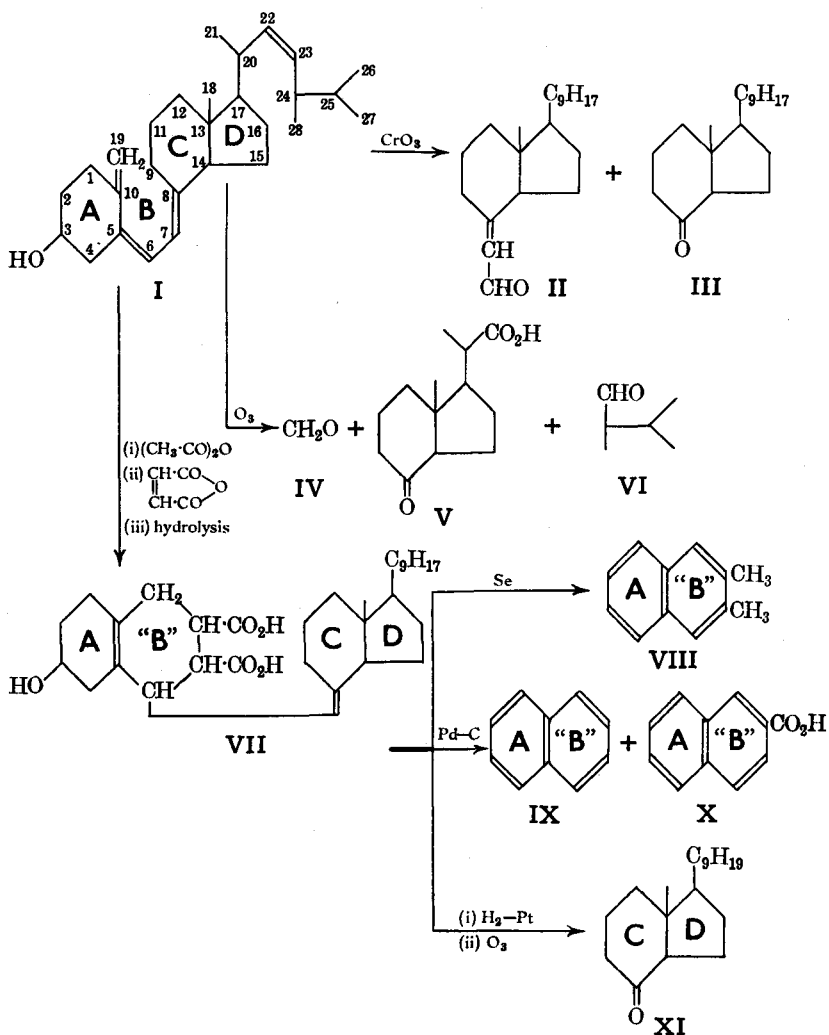

X-ray analysis studies of the 4-iodo-3-nitrobenzoate of ergocalciferol confirm structure I for ergocalciferol (Crowfoot *et al.*, 1948).

The presence of the two double bonds 5 : 6 and 7 : 8 gives rise to the possibility of various geometrical isomeric forms for ergocalciferol. Ultra-violet spectroscopic studies (Braude *et al.*, 1955) and other work (§6) have led to the conclusion that ergocalciferol has the configuration shown in the chart in §6. This is further supported by the work of Crowfoot *et al.* (1957) who, from calculations of electron densities in the ester crystal (the 4-iodo-3-nitrobenzoate), have shown that their results agree with the configuration given in the chart.

Lythgoe *et al.* (1957) have carried out a partial synthesis of ergocalciferol from the aldehyde II.

**§6b. Vitamins  $\text{D}_3$  and  $\text{D}_4$ .** A detailed biological investigation has shown that the vitamin D in cod-liver oil is not identical with ergocalciferol, and that vitamin D activity could be conferred on cholesterol, or on some

impurity in cholesterol other than ergosterol. Windaus (1935) therefore suggested that natural vitamin D (in cod-liver oil) is derived from 7-dehydrocholesterol. The following chart shows the method of preparing 7-dehydrocholesterol (originated by Windaus, 1935, and improved by Buser, 1947, and by Fieser *et al.*, 1950).

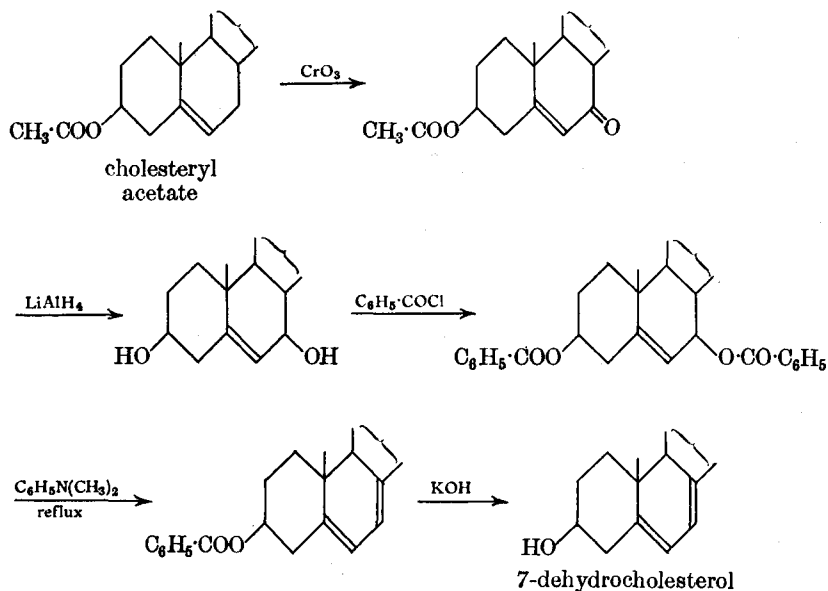

7-Dehydrocholesterol, on irradiation with ultraviolet light, gives a product that is about as active as ergocalciferol (vitamin  $\text{D}_2$ ). This product was shown to be impure, and the pure active constituent was isolated as the 3 : 5-dinitrobenzoate (Windaus *et al.*, 1936). This vitamin D with a cholesterol side-chain is named **vitamin  $\text{D}_3$** , and has been shown to be identical with the natural vitamin that is isolated from tunny-liver oil (Brockman, 1937). Vitamin  $\text{D}_3$  has also been isolated from other fish-liver oils, *e.g.*, halibut. The *Chemical Society* (1951) has proposed the name **cholecalciferol** for vitamin  $\text{D}_3$ . It has now been shown that the irradiation of 7-dehydrocholesterol (at low temperature) first produces the previtamin  $\text{D}_3$ , and this, on gentle heating, is converted into the vitamin itself (*cf.* ergocalciferol, §6).

Irradiation of 22 : 23-dihydroergosterol gives a compound with antirachitic properties (Windaus *et al.*, 1937); this is known as **vitamin  $\text{D}_4$** .

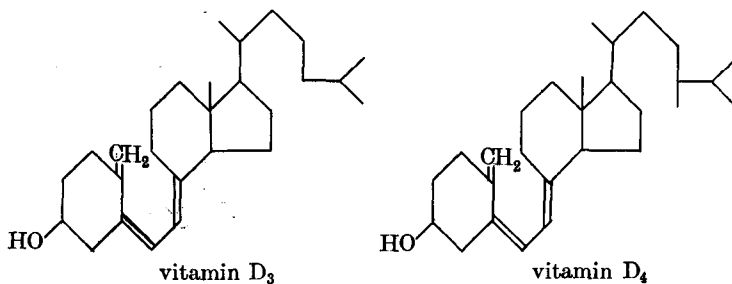

§7. **Stigmasterol**,  $\text{C}_{29}\text{H}_{48}\text{O}$ , m.p.  $170^\circ$ , is best obtained from soya bean oil. Since stigmasterol forms an acetate, etc., a hydroxyl group is therefore

present. Stigmasterol also forms a tetrabromide; thus it contains two double bonds. Hydrogenation of stigmasterol produces stigmasterol,  $C_{29}H_{52}O$ , and since the acetate of this gives the acetate of  $3\beta$ -hydroxynor-allocholic acid on oxidation with chromium trioxide, it follows that stigmasterol differs from cholesterol only in the *nature* of the side-chain (Fernholz

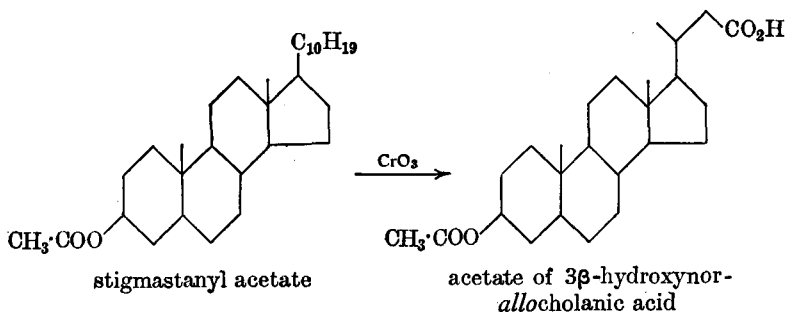

*et al.*, 1934; *cf.* ergosterol, §5). Ozonolysis of stigmasterol gives, among other products, ethylisopropylacetaldehyde (Guiteras, 1933). This suggests that the side-chain is as shown in I, with a double bond at 22 : 23.

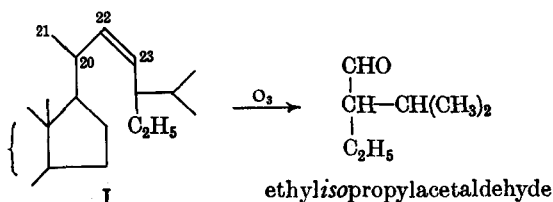

Thus the final problem is to ascertain the position of the second double bond in stigmasterol. This has been shown to be 5 : 6 by the method used for cholesterol (Fernholz, 1934). Stigmasterol, on hydroxylation with hydrogen peroxide in acetic acid, gives a triol which, on oxidation with chromium trioxide, forms a hydroxydiketone. This, on dehydration followed by reduction, forms a dione which combines with hydrazine to form a pyridazine derivative. These reactions can be explained as follows (*cf.* cholesterol, §3 ii):

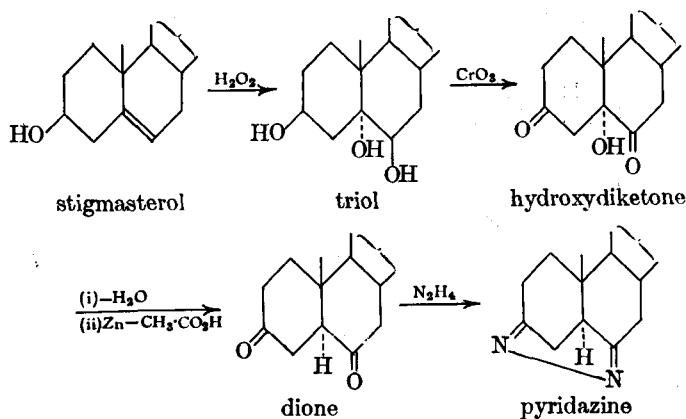

This position for the nuclear double bond is supported by other evidence; thus stigmasterol is:

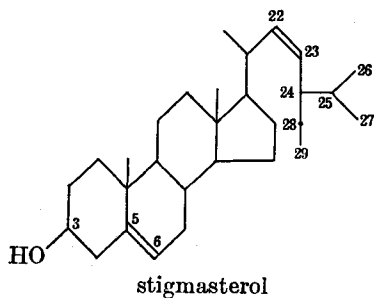

§7a. **Biosynthesis of sterols.** It has long been known that animals can synthesise cholesterol, but the possible pathways were unknown until biosynthetic cholesterol was prepared from acetic acid labelled isotopically (with  $^{14}\text{C}$ ) in either the methyl (*m*) or the carboxyl (*c*) group, or labelled in both groups ( $^{13}\text{CH}_3\cdot^{14}\text{CO}_2\text{H}$ ). These tracer studies were carried out mainly by Bloch *et al.* (1942-) and by Cornforth *et al.* (1953-), and the results established that the distribution of the carbon atoms is as shown in I. Thus

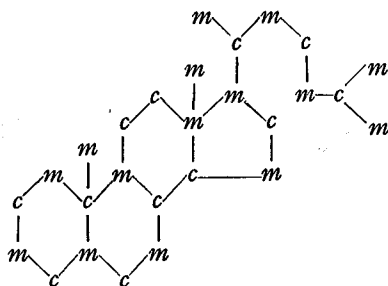

I

acetic acid can be regarded as the fundamental unit. Evidence was also obtained that *isovaleric* acid can serve as a precursor for cholesterol, and then Tavormina *et al.* (1956), using labelled mevalonic acid (MVA), showed that this is converted almost completely into cholesterol by rat liver; the route from acetic acid to MVA has been described in §32a. VIII. The problem now is to discover the route whereby MVA is converted into cholesterol. As far back as 1926 Heilbron *et al.* suggested that squalene (§32. VIII) is a precursor of cholesterol, and Robinson (1934) proposed a scheme for the cyclisation of the squalene molecule with the loss of three methyl groups. Woodward *et al.* (1953), however, suggested that squalene is first cyclised to lanosterol, and then this loses three methyl groups to give cholesterol. Bloch *et al.* (1952) showed that squalene is a precursor of cholesterol in the intact animal. Furthermore, Bloch *et al.* (1955) showed that lanosterol is converted into cholesterol in rats, and in 1956 carried out the biosynthesis of lanosterol from labelled acetate. Thus we have evidence for the suggested route from squalene to cholesterol. As mentioned above, Woodward *et al.* (1953) suggested that squalene ring-closes to form lanosterol, and proposed a 1,3-shift of the methyl group at  $\text{C}_8$  to  $\text{C}_{13}$  (the squalene molecule is numbered to give the numbering in the closed-ring system in the steroid). On the other hand, Ruzicka *et al.* (1955) and Bloch *et al.* (1957) proposed a 1,2-shift of the methyl group from  $\text{C}_{14}$  to  $\text{C}_{13}$  and another 1,2-shift from  $\text{C}_8$  to  $\text{C}_{14}$ . Further work by Bloch *et al.* (1958) showed that the 1,2-shifts were correct; this is also supported by the work of Cornforth *et al.* (1958).

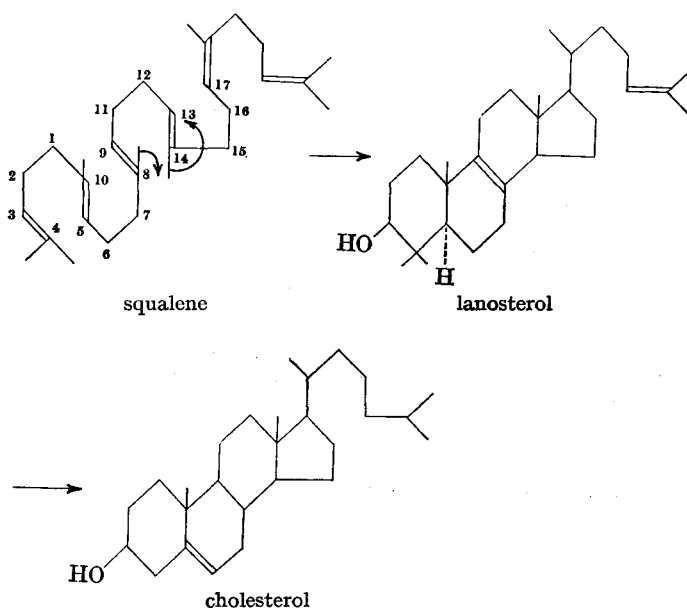

Bloch *et al.* (1957) also found that the three methyl groups of lanosterol are eliminated as carbon dioxide (*via* oxidation to carboxyl groups). Several intermediates and new precursors which function between lanosterol and cholesterol have now been identified (Cornforth, 1959; Crabbé, 1959). Finally, studies with yeast extracts have shown the mevalonic acid 5-pyrophosphate, *isopentenyl* pyrophosphate, geranyl pyrophosphate and farnesyl pyrophosphate are successive intermediates in the biosynthesis of squalene (see §32a. VIII).

The biosynthesis of ergosterol from acetate has been carried out by Bloch *et al.* (1951), and the distribution pattern corresponds to that of cholesterol. Bloch *et al.* (1957) also showed that formate is an efficient source for the methyl group at  $C_{28}$ .

### BILE ACIDS

**§8. Introduction.** The bile acids occur in bile (a secretion of the liver which is stored in the gall-bladder) of most animals combined as amides with either glycine ( $NH_2 \cdot CH_2 \cdot CO_2H$ ) or taurine ( $NH_2 \cdot CH_2 \cdot CH_2 \cdot SO_3H$ ), *e.g.*, glycocholic acid (= glycine + cholic acid), taurocholic acid (= taurine + cholic

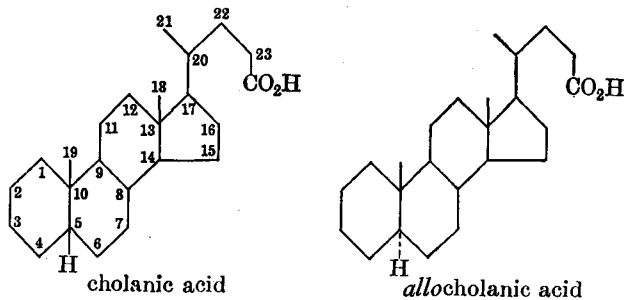



acid). The bile acids are present as sodium salts, and they function as emulsifying agents in the intestinal tract, *e.g.*, fats, which are insoluble in water, are rendered "soluble", and so may be absorbed in the intestine.

The bile acids are hydroxy derivatives of either cholanic acid or *allo*-cholanic acid (but see §10). Dehydration of a bile acid by heating in a vacuum, followed by catalytic reduction, gives either cholanic or *allo*cholanic acid.

About twelve natural bile acids have been characterised, and a number of others are synthetic. The positions of the hydroxyl groups are any of the following: 3, 6, 7, 11, 12 and 23, and in almost all of the natural bile acids the configurations of the hydroxyl groups are  $\alpha$  (see §4b). Some of the more important natural bile acids are:

Name	M.p.	Hydroxyl groups	Source
Cholic acid . . . . .	195°	3 $\alpha$ : 7 $\alpha$ : 12 $\alpha$	Man, ox
Deoxycholic acid . . . . .	172°	3 $\alpha$ : 12 $\alpha$	Man, ox
Lithocholic acid . . . . .	186°	3 $\alpha$	Man, ox
Chenodeoxycholic acid . . . . .	140°	3 $\alpha$ : 7 $\alpha$	Man, ox, hen
Hyodeoxycholic acid . . . . .	197°	3 $\alpha$ : 6 $\alpha$	Pig

§9. The structures of cholanic acid and *Allo*cholanic acid. These acids may be derived from coprostane and cholestane, respectively, as follows (*cf.* §4c). At the same time, these reactions show the relationship between the bile acids and the sterols (Windaus, 1919).

#### *Allo*cholanic acid.

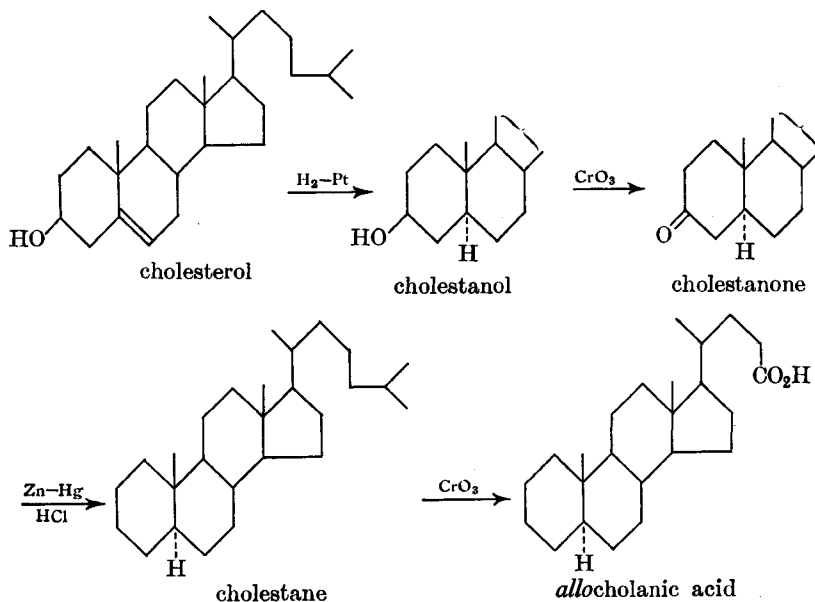

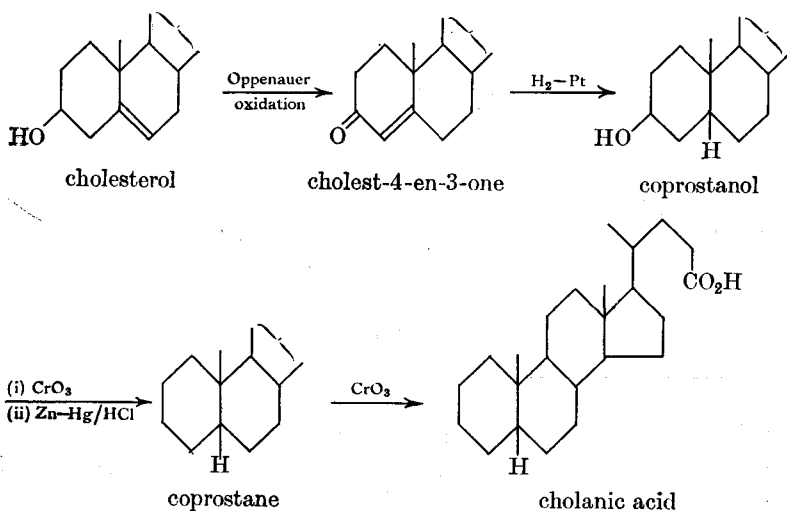
**Cholanic acid.**

**§10. Structure of the bile acids.** Since all the bile acids can be converted into either of the cholanic acids, the former are therefore hydroxy derivatives of the latter, *e.g.*, lithocholic acid can be converted into cholanic acid as follows:

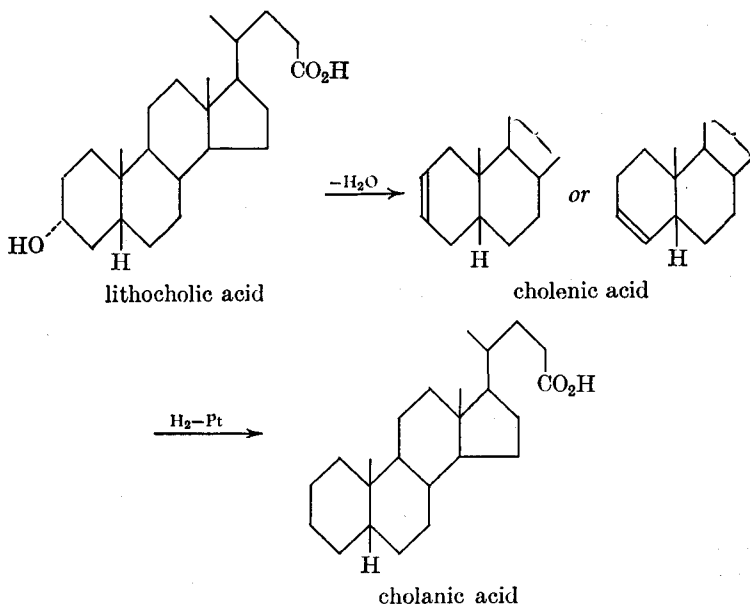

According to Fieser *et al.* (1955), cholenic acid is a mixture of the two compounds shown, the chol-3-enic acid being the main constituent.

The positions of the hydroxyl groups in the bile acids have been determined by means of oxidative degradation, *e.g.*, the position of the hydroxyl group in lithocholic acid is shown to be at 3 as follows. Cholesterol can be

converted into coprostanol I (see, *e.g.*, §9) which, on oxidation with chromium trioxide, forms a ketone and this, when oxidised with nitric acid, gives a dicarboxylic acid, II. II, on further oxidation with nitric acid, produces the tricarboxylic acid, lithobilianic acid, III. Lithocholic acid, IV, on oxidation with chromium trioxide, forms dehydrolithocholic acid, V, and this, when oxidised with nitric acid, forms III. It therefore follows that the hydroxyl group in lithocholic acid is probably in the same position as in coprostanol, *viz.*, position 3. Thus:

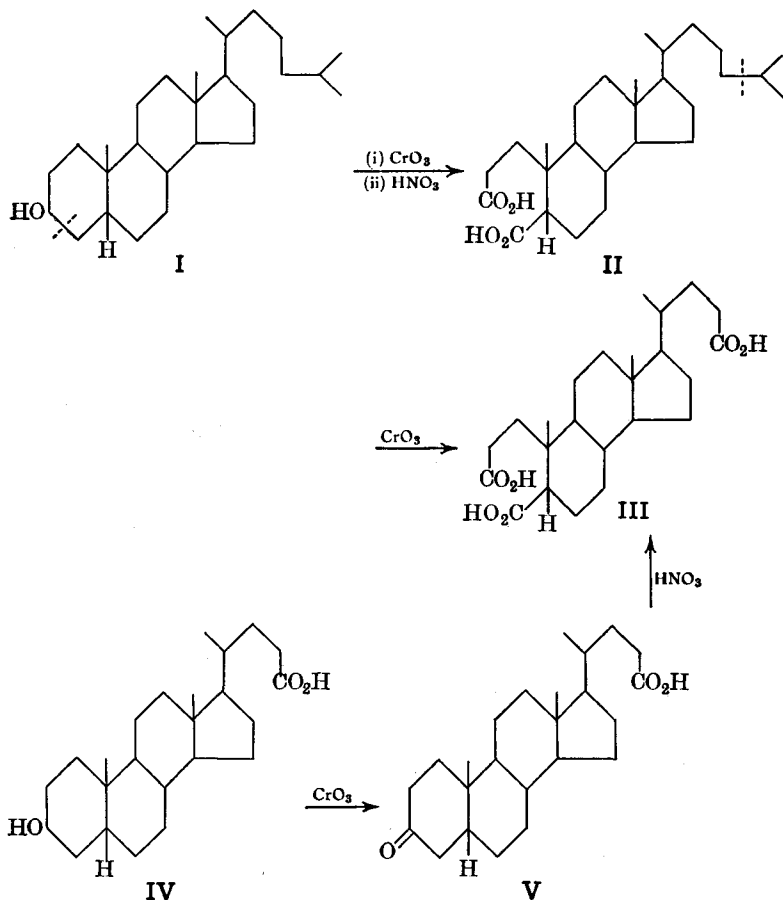

The above evidence is not conclusive, since had the hydroxyl group in lithocholic acid been at position 4, III could still have been obtained. In practice, however, the oxidation of I produces two isomeric acids for II, one being II as shown, and the other II $a$ , in which the ring A is opened between C $_2$  and C $_3$ ; this acid, on further oxidation, gives *isolithobilianic acid*, III $a$ . Since the oxidation of lithocholic acid, IV, also produces a mixture of the *same* two acids, III and III $a$ , there can be no doubt that the hydroxyl group is at position 3.

The configuration of the hydroxyl group in lithocholic acid has been shown to be  $\alpha$ , *e.g.*, the oxidative degradation of the acetates of lithocholic acid and epicoprostanol to 5-*isoandrosterone* (formerly known as 3 $\alpha$ -hydroxy- $\alpha$ -tiocolan-17-one). Since all of the natural bile acids except one (" $\beta$ ")

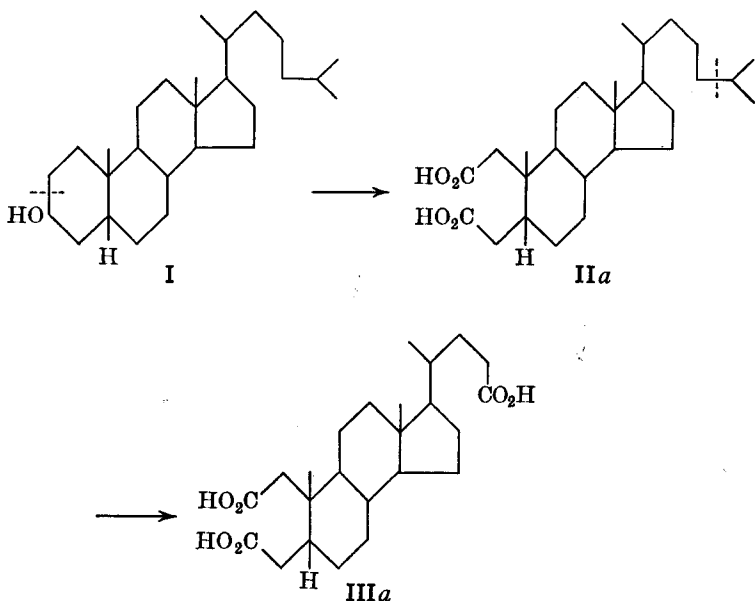

hyodeoxycholic acid) can be converted into lithocholic acid, all have therefore the  $\alpha$ -configuration for the hydroxyl group at C<sub>3</sub>.

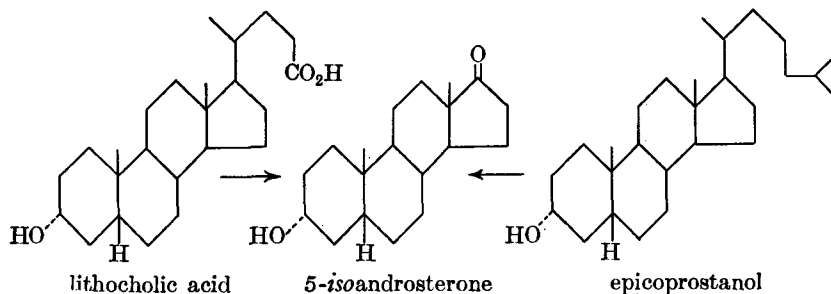

The bile acids form molecular compounds with various substances. Cholic acid, in particular, forms these molecular compounds with such compounds as fatty acids, esters, alcohols, etc.; these are known as the **choleic acids**. These choleic acids are of the channel complex type (like urea complexes; see Vol. I).

The bile acids discussed in the foregoing account are all derivatives of cholanolic or *allocholanolic* acid. There are, however, some bile acids which are not derivatives of the cholanolic acids, *e.g.*, in the bile of crocodiles there is the bile acid  $3\alpha : 7\alpha : 12\alpha$ -trihydroxycoprostanic acid, C<sub>27</sub>H<sub>46</sub>O<sub>5</sub>.

## SEX HORMONES

**§11. Introduction.** Hormones are substances which are secreted by the ductless glands, and only minute amounts are necessary to produce the various physiological reactions in the body. As a group, hormones do not resemble one another chemically, and their classification is based on their physiological activity. There appear to be about 60 different hormones recognised so far, and more than half of these are steroids. The sex hormones

belong to the steroid class of compounds, and are produced in the gonads (testes in the male, and ovaries in the female). Their activity appears to be controlled by the hormones that are produced in the anterior lobe of the pituitary gland. Because of this, the sex hormones are sometimes called the secondary sex hormones, and the hormones of the anterior lobe of the pituitary (which are protein in nature) are called the primary sex hormones.

The sex hormones are of three types: the **androgens** (male hormones), the **oestrogens** (female or follicular hormones) and **progesterone** (the corpus luteum hormone). The sex hormones are responsible for the sexual processes, and for the secondary characteristics which differentiate males from females.

### ANDROGENS

§12. **Androsterone**,  $C_{19}H_{30}O_2$ , m.p. 184–185°, is dextrorotatory. It was first isolated by Butenandt *et al.* (1931) from male urine (about 15 mg. from 15,000 litres of urine). Androsterone behaves as a saturated compound, and since it forms mono-esters, *one* oxygen atom is present as a hydroxyl group. The functional nature of the other oxygen atom was shown to be oxo, since androsterone forms an oxime, etc. The parent hydrocarbon of androsterone,  $C_{19}H_{30}O_2$ , is therefore  $C_{19}H_{32}$ , and since this corresponds to the general formula  $C_nH_{2n-6}$ , the molecule is tetracyclic. This led to the suggestion that androsterone probably contains the steroid nucleus, and since it is a hydroxyketone, it was thought that it is possibly related to

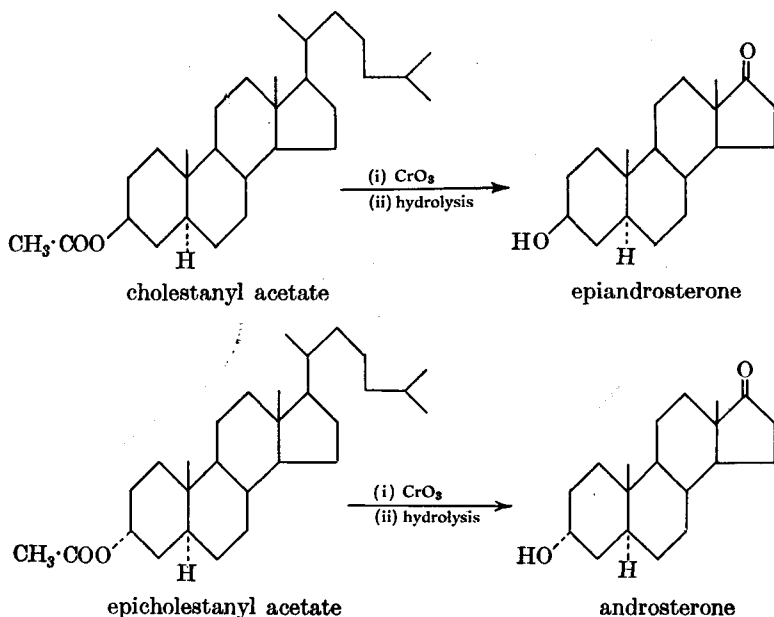

oestrone (§14). Butenandt (1932) therefore proposed a structure which was proved correct by Ruzicka (1934) as follows. Ruzicka oxidised cholestanyl acetate with chromium trioxide in acetic acid to **epiandrosterone**, a hydroxyketone with the structure proposed for androsterone by Butenandt. When, however, epicholestanyl acetate was oxidised, the product was androsterone. Thus the configuration of the hydroxyl group at  $C_3$  is  $\alpha$  and not  $\beta$  as Butenandt suggested. Epiandrosterone (formerly known as *isoandrosterone*) has about one-eighth of the activity of androsterone.

Sondheimer *et al.* (1955) have converted epiandrosterone into androsterone, starting with epiandrosterone *p*-toluenesulphonate (*cf.* tosyl esters of sugars, §9. VII).

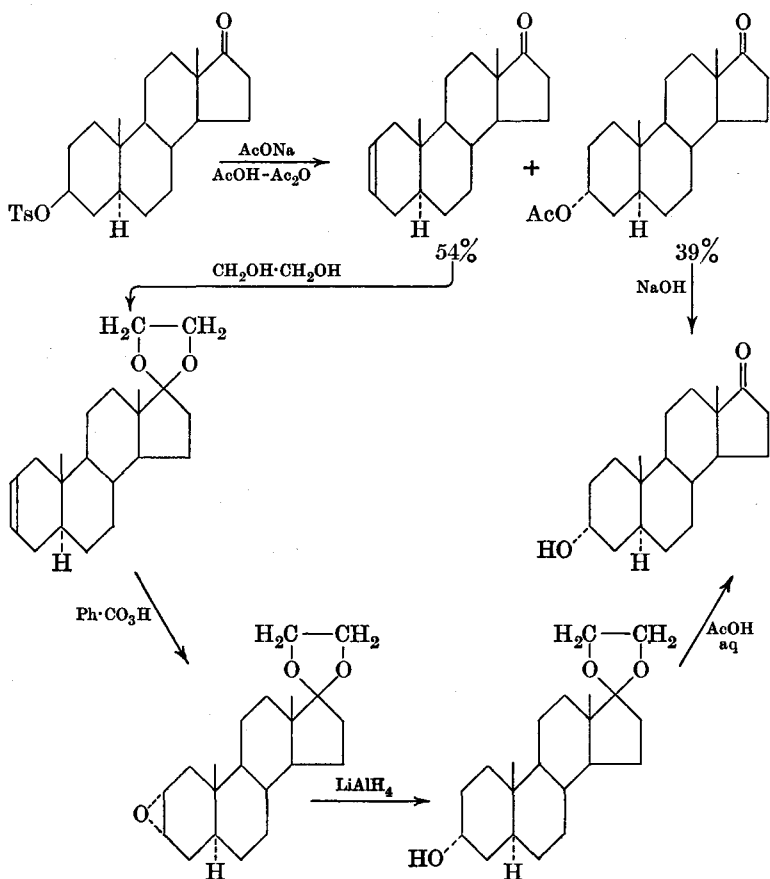

Soon after the discovery of androsterone, Butenandt *et al.* (1934) isolated two other hormones from male urine, 5-*iso*androsterone and dehydroepiandrosterone. Then Laqueur (1935) isolated the hormone testosterone from steer testes (10 mg. from 100 kg. of testes).

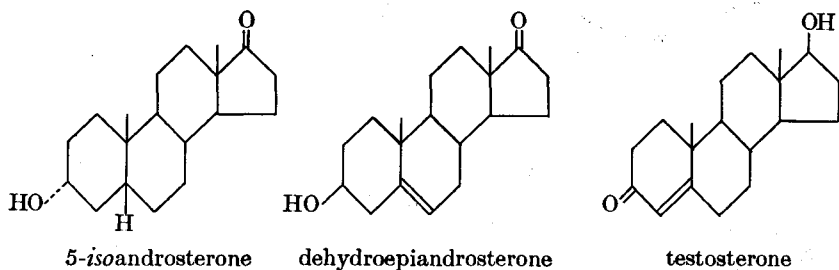

§13. **Testosterone**,  $\text{C}_{19}\text{H}_{28}\text{O}_2$ , m.p.  $155^\circ$ , is dextrorotatory. Testosterone has been produced commercially by the following method of Butenandt

(1935) and Ruzicka (1935); the Oppenauer oxidation step in this method was introduced by Oppenauer (1937). This preparation of testosterone establishes the structure of this hormone. This method has been improved

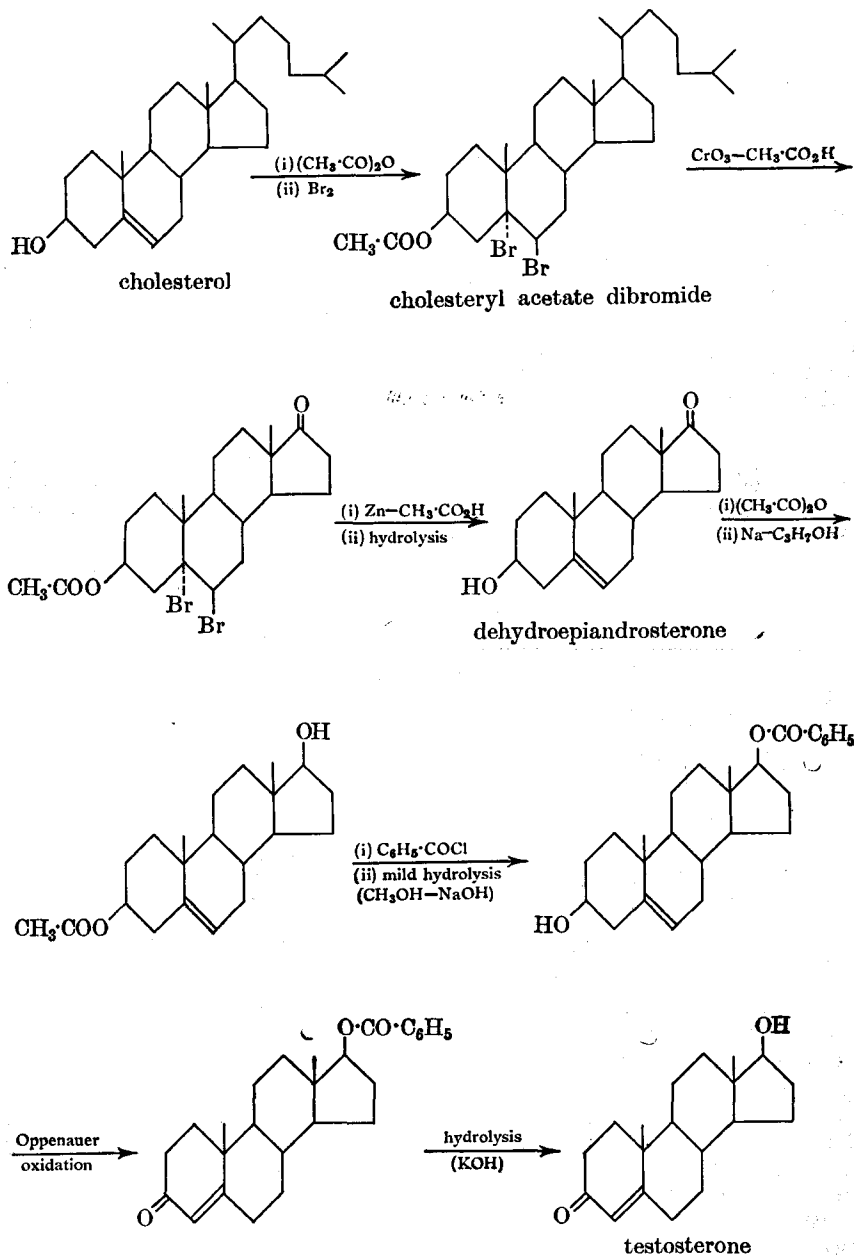

by Mamoli (1938), who converted dehydroepiandrosterone into testosterone by means of micro-organisms; the first stage uses an oxidising yeast in the presence of oxygen, and the second stage a fermenting yeast.

Elisberg *et al.* (1952) have shown that sodium borohydride selectively reduces the 3-keto group in the presence of others at 11, 12, 17 or 20. On

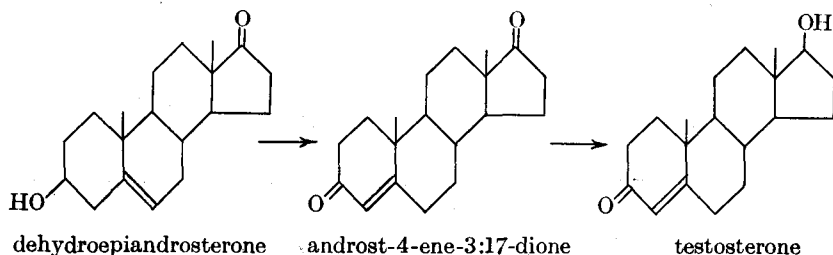

the other hand, Norymberski *et al.* (1954) have shown that if there is a double bond in position 4 : 5, then the keto group at 17 or 20 is preferentially reduced to that at 3. Thus androst-4-ene-3 : 17-dione is reduced to testosterone by sodium borohydride (*cf.* §3 i). Johnson *et al.* (1960) have adapted Johnson's synthesis of equilenin (§17) to provide an improved synthesis of testosterone.

It appears that testosterone is the real male sex hormone in the body; the others are metabolic products of testosterone. The ketonic steroids are separated from the non-ketonic steroids (all from urine) by means of Girard's reagents (P and T); the ketonic compounds form *soluble* derivatives, and may be regenerated by hydrolysis (see also Vol. I). Many other hormones have also been isolated from urine.

### ŒSTROGENS

**§14. Œstrone.** It has been known for a long time that there are hormones which control the uterine cycle, but it was not until 1929 that Butenandt and Doisy independently isolated the active substance **œstrone** from the urine of pregnant women. Œstrone is the first known member of the sex hormones, and soon after its discovery two other hormones were isolated, œstriol and œstradiol.

(+)-Œstrone, m.p. 259°, has the molecular formula  $C_{18}H_{22}O_2$ . It behaves as a ketone (forms an oxime, etc.), and contains one hydroxyl group (it forms a monoacetate and a monomethyl ether). Furthermore, this hydroxyl group is *phenolic*, since œstrone couples with diazonium salts in alkaline solution (this reaction is typical of phenols). When distilled with zinc dust, œstrone forms chrysene; this led to the suggestion that œstrone is related to the steroids (*cf.* §1). The X-ray analysis of œstrone also indicates the presence of the steroid nucleus, and at the same time showed that the keto group and the hydroxyl group are at the opposite ends of the molecule (Bernal; 1932). On catalytic hydrogenation, œstrone forms octahydro-œstrone,  $C_{18}H_{30}O_2$ . This compound contains two hydroxyl groups (two hydrogen atoms are used for converting the keto group to an alcoholic group), and so six hydrogen atoms are used to saturate *three* double bonds. If these three double bonds are in one ring, *i.e.*, there is a benzenoid ring present, then the phenolic hydroxyl group can be accounted for. The presence of one benzene ring in the structure of œstrone is supported by measurements of the molecular refractivity and the ultraviolet absorption spectrum.

When the methyl ether of œstrone is subjected to the Wolff-Kishner reduction, and the product distilled with selenium, 7-methoxy-1 : 2-cyclopentenophenanthrene is formed. The structure of this compound was established by the following synthesis (Cook *et al.*, 1934):



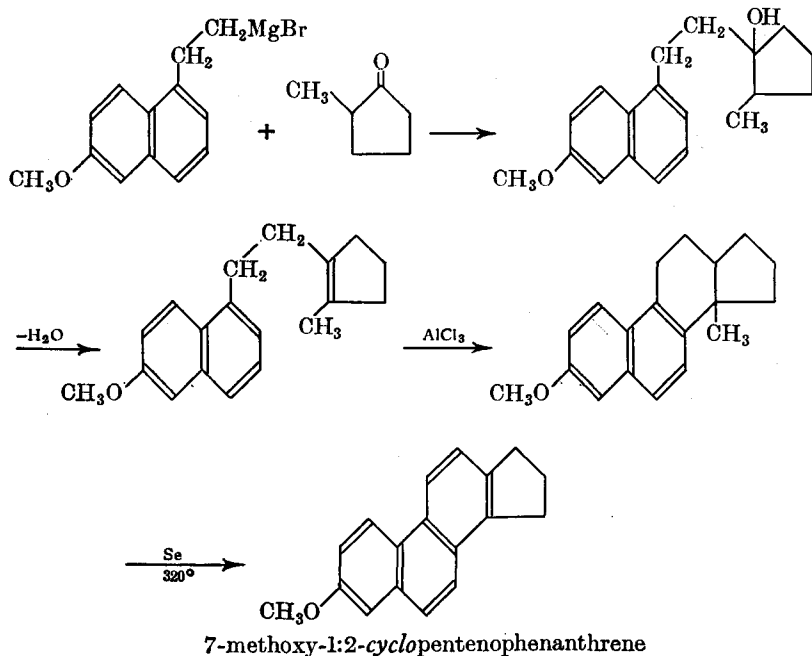

Thus the benzene ring in œstrone is ring A, and the (phenolic) hydroxyl group is at position 3; hence the skeleton of œstrone is:

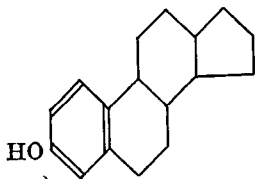

Into this skeleton we must fit the keto group, and since this skeleton contains only 17 carbon atoms, another carbon atom must also be placed. The position of the keto group was shown to be at 17, and the extra carbon atom was shown to be an angular methyl group at position 13, as follows (Cook *et al.*, 1935). When the methyl ether of œstrone, I, is treated with methylmagnesium iodide, compound II is obtained. When II is dehydrated with potassium hydrogen sulphate to III, this catalytically reduced to IV, and then IV distilled with selenium, the product is 7-methoxy-3':3'-dimethyl-1:2-cyclopentenophenanthrene, V. The formation of V can be explained only if there is a keto group at position 17 and an angular methyl group at position 13. It should be noted that in the given equations, the dehydration is accompanied by the migration of the angular methyl group; this assumption is based on the analogy with known examples in which this occurs (see overleaf).

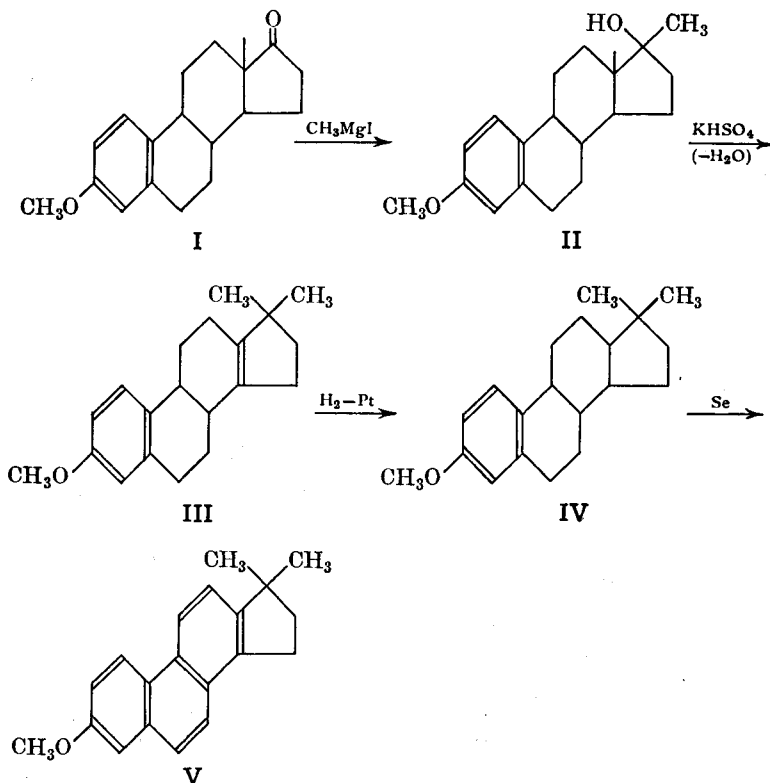

The structure of V has been confirmed by synthesis (Cook *et al.*, 1935). Thus the structure of oestrone is:

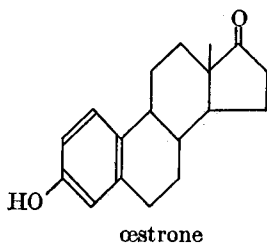

This has been confirmed by the synthesis of Anner and Miescher (1948). These authors started with the phenanthrene derivative VI, which had been prepared previously by Robinson *et al.* (1938), and by Bachmann *et al.* (1942). The first step of the Anner-Miescher synthesis involves the Reformatsky reaction, and a later one the Arndt-Eistert synthesis.

The stereochemical problems involved in the synthesis of oestrone are not so complicated as in cholesterol, since only four asymmetric carbon atoms are present in the hormone (*cf.* §3). VI contains 3 asymmetric carbon atoms, and so four racemates are possible. Three have been isolated by Anner and Miescher, and one of these was converted into ( $\pm$ )-oestrone (C/D *trans*) and the stereoisomer (C/D *cis*) as shown above. These were separated and the

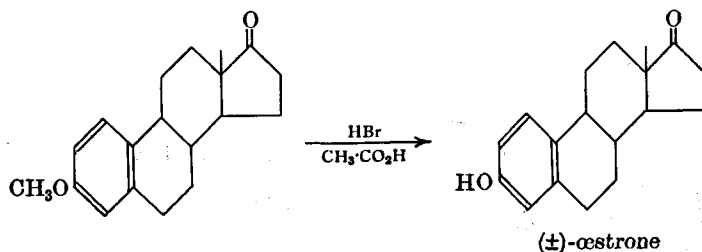
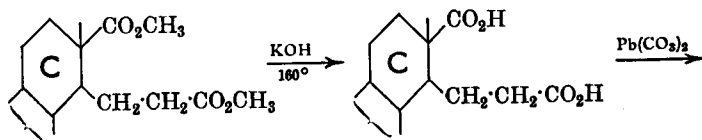
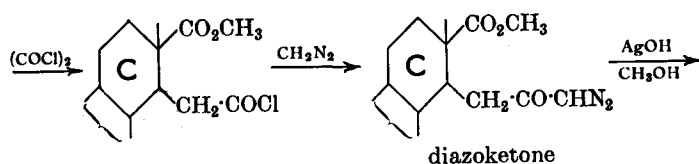
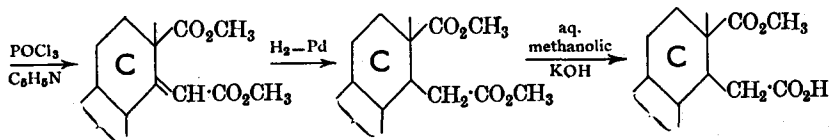
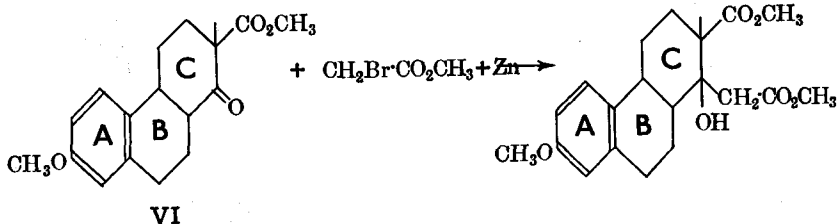

(±)-œstrone resolved with (–)-menthoxyacetic acid. The (+)-enantiomorph that was obtained was shown to be identical with the natural compound.

Johnson *et al.* (1958, 1962) have carried out a total synthesis of œstrone; each step in their synthesis was stereoselective. Hughes *et al.* (1960) have reported total syntheses of œstrone which appear to be simpler than any previous method and just as efficient.

§15. **œstriol**,  $\text{C}_{18}\text{H}_{24}\text{O}_3$ , m.p.  $281^\circ$ , was isolated from human pregnancy urine by Marrian (1930). Since œstriol forms a triacetate, three hydroxyl groups must be present in the molecule. One was shown to be phenolic (*cf.* œstrone), and the other two secondary alcoholic, since, on oxidation, a diketone is produced. Furthermore, X-ray analysis indicates that the two alcoholic groups are in the *vicinal* position (*i.e.*, 1:2-). When œstriol is heated with potassium hydrogen sulphate, one molecule of water is removed

and œstrone is produced. It therefore follows that œstriol has the same carbon skeleton as œstrone, and that the two alcoholic groups in œstriol are at positions 16 and 17. Structure I for œstriol fits the above facts, and is supported by the following evidence. When fused with potassium hydroxide, œstriol forms marrianolic acid, II, and this, on dehydrogenation with selenium, is converted into a hydroxydimethylphenanthrene, III, which, on distillation with zinc dust, gives a dimethylphenanthrene, IV. The structure of IV was shown to be 1 : 2-dimethylphenanthrene by synthesis, and since marrianolic acid forms an anhydride when heated with acetic anhydride, it therefore follows that œstriol contains a phenanthrene nucleus and a five-membered ring, the position of the latter being 1 : 2 (where the two methyl groups are in IV). Finally, the structure of III was shown to be 7-hydroxy-1 : 2-dimethylphenanthrene by synthesis (Haworth *et al.*, 1934), and so if I is the structure of œstriol, the degradation to the phenanthrene derivatives may be explained as follows:

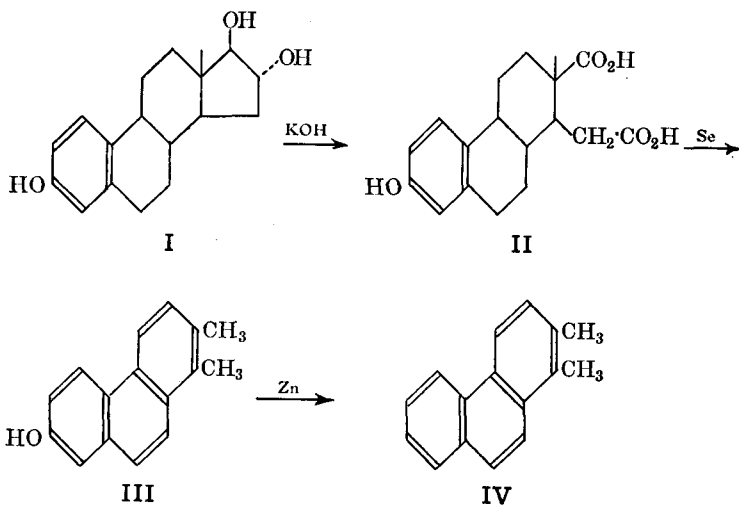

The chemical relationship between œstrone, œstriol and œstradiol (§16) is shown by the following reactions.

(i) œstrone may be reduced to œstradiol by catalytic hydrogenation, by aluminium *isopropoxide* (the Meerwein-Ponndorf-Verley reduction), or by lithium aluminium hydride.

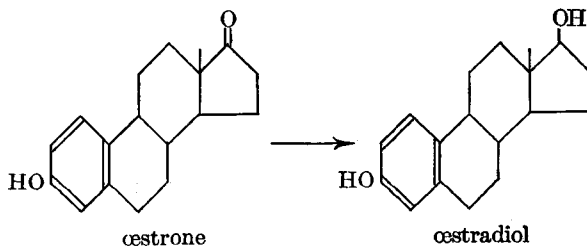

(ii) œstriol may be converted into œstrone by the action of potassium hydrogen sulphate (see above), and œstrone may be converted into œstriol as follows (Huffman *et al.*, 1947, 1948).

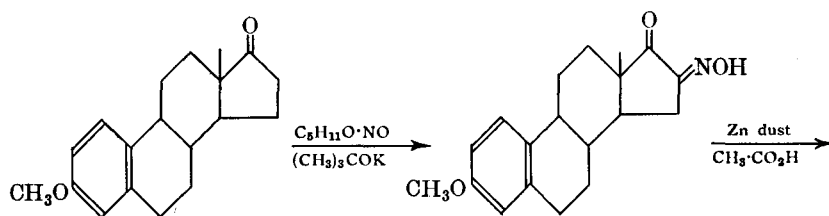

methyl ether of oestrone

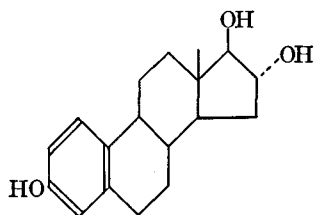
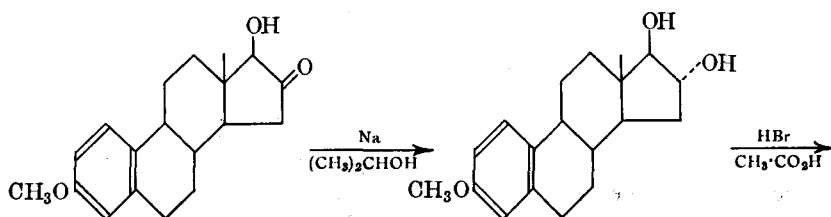

Leeds *et al.* (1954) have converted oestrone into oestriol by a simpler method:

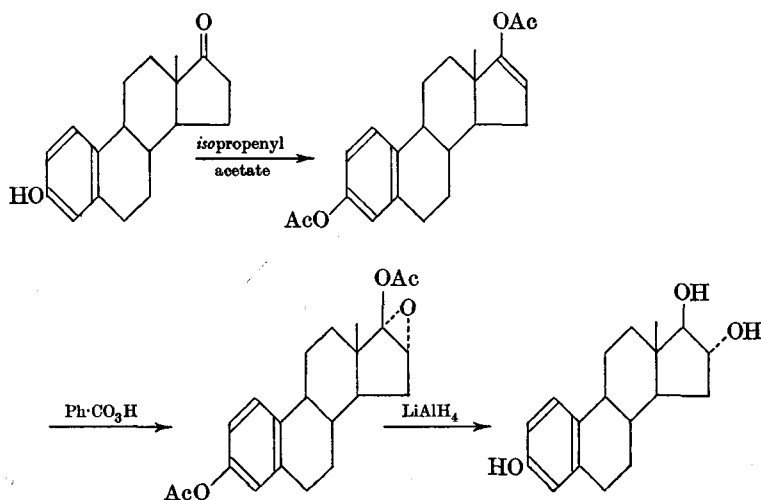

Oestriol is more soluble than oestrone in water, and is more potent than either oestrone or oestradiol when taken orally.

§16. **Œstradiol**,  $C_{18}H_{24}O_2$ . There are two stereoisomeric œstradiols,  $\alpha$  and  $\beta$ ; the  $\alpha$ -isomer is much more potent than the  $\beta$ -.

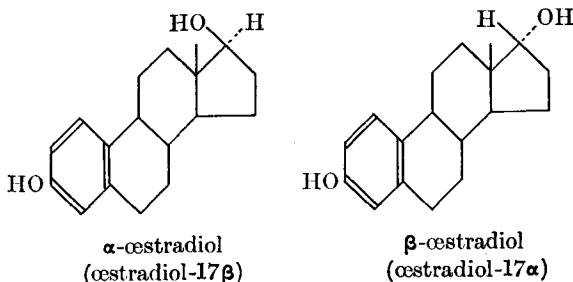

$\alpha$ -Œstradiol was first obtained by the reduction of œstrone (see §15), but later it was isolated from the ovaries of sows (Doisy *et al.*, 1935). When the phenolic methyl ether of œstradiol is heated with zinc chloride, a molecular rearrangement occurs, the angular methyl group migrating to the cyclopentane ring D (*cf.* §2 viii. X). This compound, when dehydrogenated with selenium, produces 7-methoxy-3'-methyl-1:2-cyclopentenophenanthrene, the structure of which has been ascertained by synthesis (Cook *et al.*, 1934). Thus the structure of œstradiol is established.

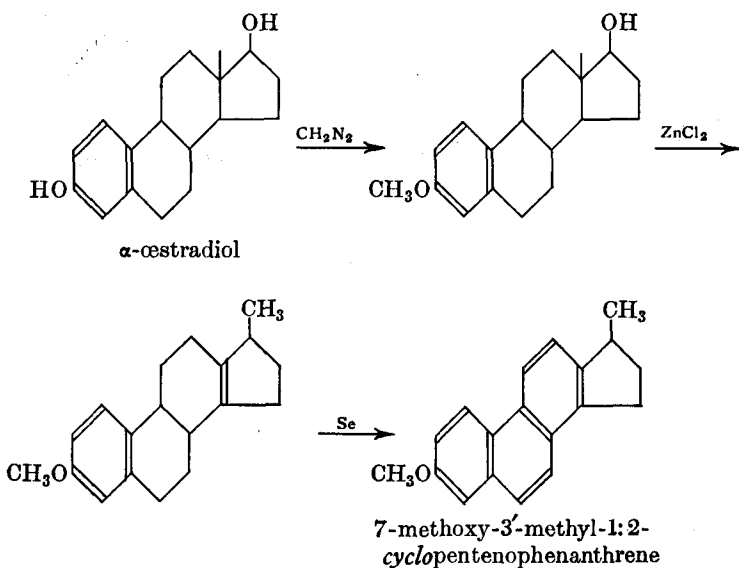

Velluz *et al.* (1960) have synthesised œstradiol starting from 6-methoxy-1-tetralone; this is therefore a total synthesis of the hormone.

$\beta$ -Œstradiol has been isolated from the pregnancy urine of mares (Wintersteiner *et al.*, 1938).  $\alpha$ -Œstradiol is much more active than œstrone, whereas  $\beta$ -œstradiol is much less active. It appears that œstradiol is the real hormone, and that œstrone and œstriol are metabolic products. It might be noted here that when the second œstradiol was discovered, the earlier one was arbitrarily designated as the " $\alpha$ "-isomer. Subsequently, this

isomer was shown to have the  $17\beta$  configuration, and the " $\beta$ "-isomer the  $17\alpha$  configuration.

A very active synthetic oestrogen is **17 $\alpha$ -ethinyloestradiol**, and has the advantage that it is very active when taken orally. This synthetic compound has been prepared by the action of acetylene on oestrone in a solution of liquid ammonia containing potassium.

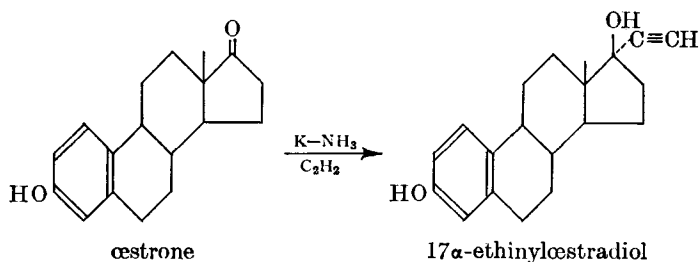

**§17. (+)-Equilenin**,  $\text{C}_{18}\text{H}_{18}\text{O}_2$ , m.p. 258–259°, has been isolated from the urine of pregnant mares by Girard *et al.* (1932); it is not a very potent oestrogen. The reactions of equilenin show that a phenolic hydroxyl group and a ketonic group are present, and also that the molecule contains five double bonds (*cf.* oestrone, §14). When the methyl ether of equilenin is treated with methylmagnesium iodide, then the alcohol dehydrated, catalytically reduced and then dehydrogenated with selenium, the product is 7-methoxy-3':3'-dimethyl-1:2-cyclopentenophenanthrene, II (*cf.* oestrone, §14). Thus the structure of equilenin is the same as that of oestrone, except that the former has two more double bonds than the latter (Cook *et al.*, 1935). Now the absorption spectrum of equilenin shows that it is a naphthalene derivative. Thus, since ring A in oestrone is benzenoid, it appears probable that ring B in equilenin is also benzenoid, *i.e.*, rings A and B form the naphthalene nucleus in equilenin. All the foregoing reactions of equilenin may be readily explained by assuming that I is its structure, and further evidence that has been given to support this is the claim by Marker *et al.* (1938) that equilenin may be reduced to oestrone, III, by sodium and ethanol. This reduction, however, has apparently never been substantiated (*cf.* Dauben *et al.*, 1956).

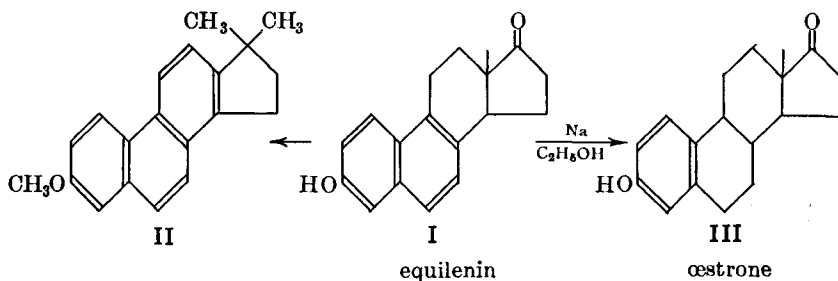

This structure of equilenin has been confirmed by synthesis. The first synthesis was by Bachmann *et al.* (1940), but was somewhat improved by Johnson *et al.* (1947). In the following chart, compound IV is synthesised by the method of Bachmann, and the rest of the synthesis is that of Johnson,

who started with compound IV (Johnson's synthesis involves fewer steps than Bachmann's).

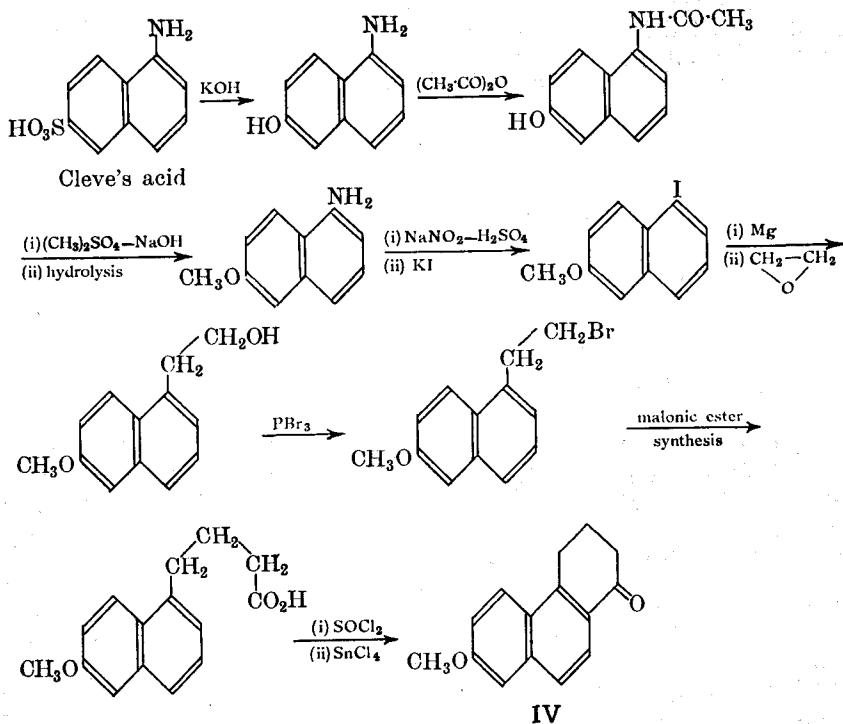



Johnson's synthesis starting from IV.

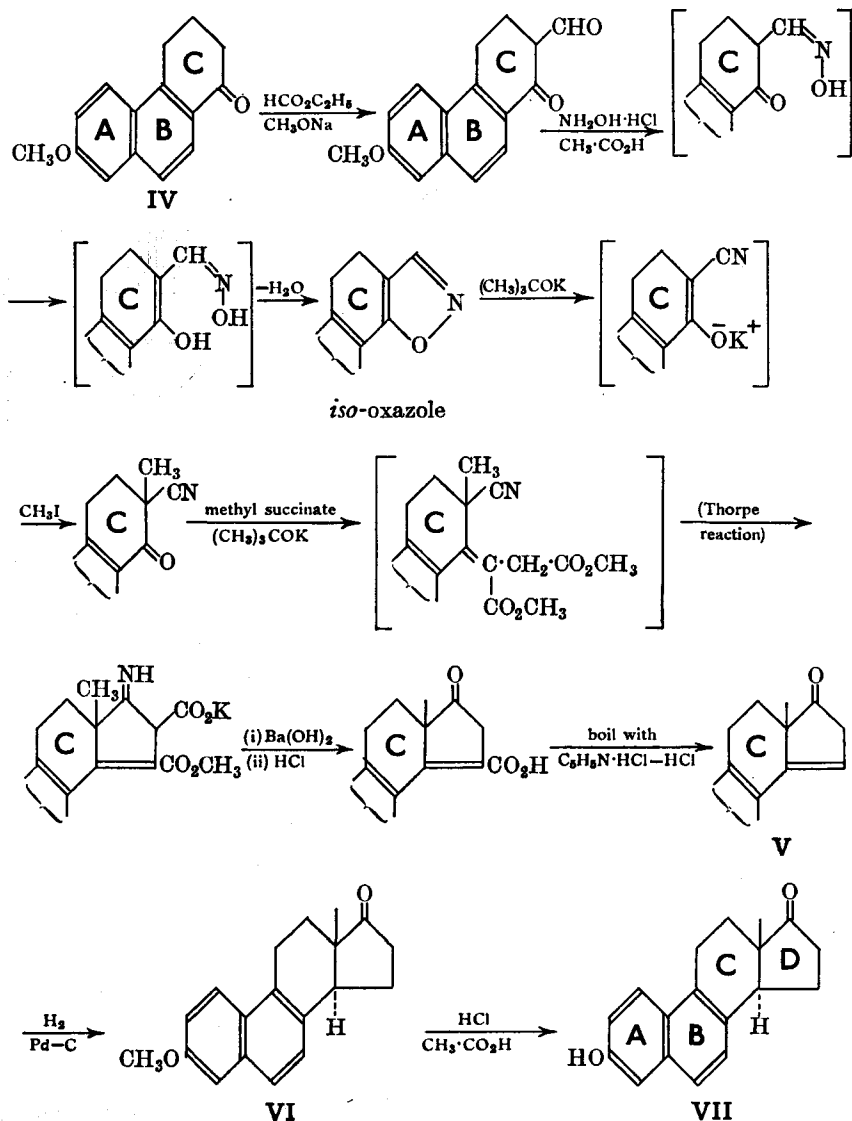

Reduction of V gives a mixture of (±)-equilenin methyl ether, VI (rings C/D *trans*), and isoequilenin methyl ether (rings C/D *cis*); these are separated by fractional crystallisation from acetone-methanol, the equilenin derivative being the less soluble isomer. Product VII is (±)-equilenin, and is resolved *via* the menthoxyacetic ester. The (+)-equilenin so obtained is identical with the natural product. It should be noted here that equilenin contains only two asymmetric carbon atoms, and so the stereochemical problems involved are far simpler than those for cholesterol and œstrone.

§17a. (+)-Equilin, C<sub>18</sub>H<sub>20</sub>O<sub>2</sub>, m.p. 238–240°, has also been isolated from the urine of pregnant mares (Girard *et al.*, 1932), and its structure has been shown to be:

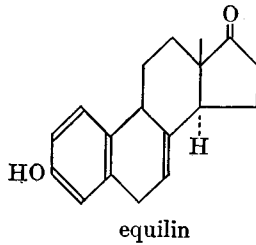

§18. **Artificial hormones.** Many compounds with oestrogenic activity but not of steroid structure have been prepared synthetically.

**Stilboestrol** (4 : 4'-dihydroxydiethylstilbene) was prepared by Dodds *et al.* (1939) as follows:

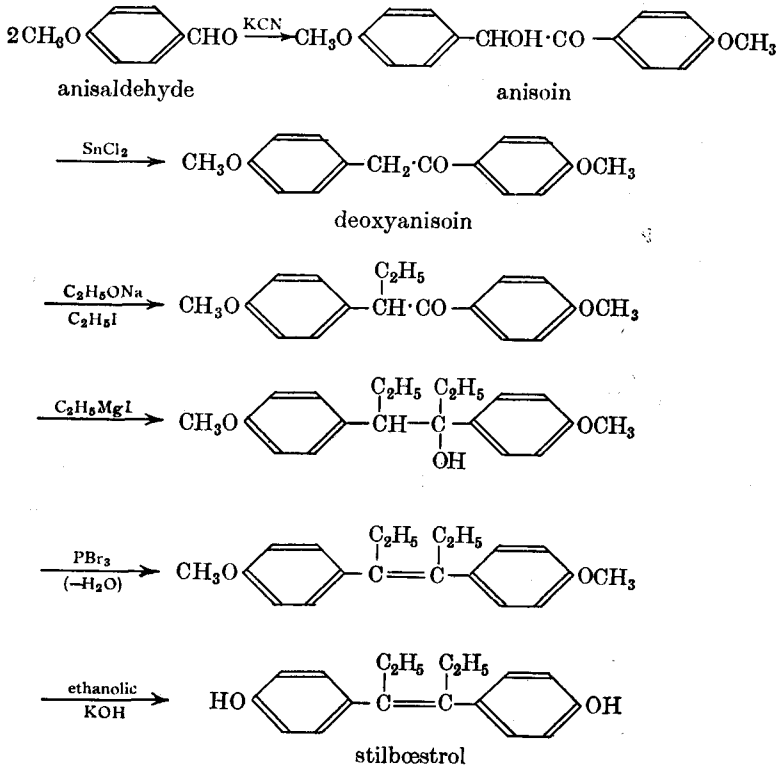

The above structure of stilboestrol can exist in two geometrical isomeric forms; it is the *trans*-form which is the active substance, and this configuration has been confirmed by X-ray analysis (Crowfoot *et al.*, 1941).

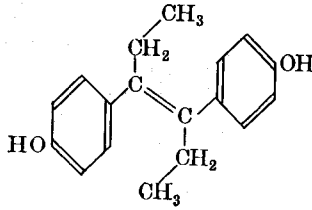

Kharasch *et al.* (1943) have introduced a simpler synthesis of stilboestrol. Anethole is treated with hydrobromic acid and the product, anethole hydrobromide, is then treated with sodamide in liquid ammonia. The resulting compound, I, gives stilboestrol on demethylation and isomerisation in the presence of alkali. The structure of I is uncertain, but it is believed to be the one given.

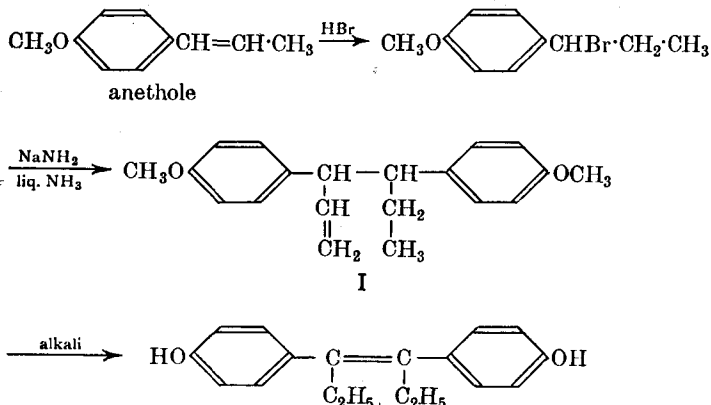

Stilboestrol is more active than oestrone when administered subcutaneously, and it can also be given orally.

**Hexoestrol** (dihydrostilboestrol) may be prepared from anethole hydrobromide as follows:

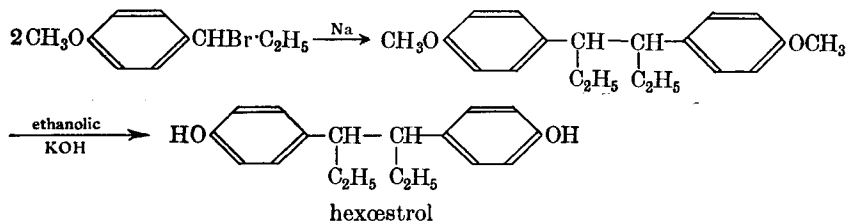

The active form is the *meso*-isomer (as shown by X-ray crystallography by Crowfoot *et al.*, 1941), and this compound appears to be the most potent of the oestrogens.

### GESTOGENS

§19. **Progesterone**,  $\text{C}_{21}\text{H}_{30}\text{O}_2$ , m.p.  $128^\circ$ , was first isolated in a pure form by Butenandt *et al.* (1934) from the *corpora lutea* of pregnant sows.

The chemical reactions of progesterone show that there are two keto groups present, and since on catalytic reduction three molecules of hydrogen are added to form the dialcohol  $\text{C}_{21}\text{H}_{36}\text{O}_2$ , it therefore follows that progesterone contains one double bond (four hydrogen atoms are used to convert the two keto groups to alcoholic groups). Thus the parent hydrocarbon of progesterone is  $\text{C}_{21}\text{H}_{36}$ , and since this corresponds to the general formula  $\text{C}_n\text{H}_{2n-6}$ , progesterone is therefore tetracyclic. Furthermore, X-ray studies have shown that progesterone contains the steroid nucleus, and this is further supported by the fact that progesterone may be prepared from, *e.g.*, stigmasterol and cholesterol. These preparations also show the structure of progesterone, but do not provide conclusive evidence for the position of the double bond in progesterone, since the results can be interpreted equally well on the assumption that the double bond is 4 : 5 or 5 : 6. The

absorption spectrum of progesterone, however, shows that it is an  $\alpha : \beta$ -unsaturated ketone, and this suggests that the position of the double bond is 4 : 5 (see below). Finally, progesterone has also been synthesised from diosgenin and from pregnanediol, and the preparation from the latter, taken in conjunction with the others, definitely shows that the position of the double bond in progesterone is 4 : 5.

(i) *Progesterone from stigmasterol* (Butenandt *et al.*, 1934, with improvements by other workers).

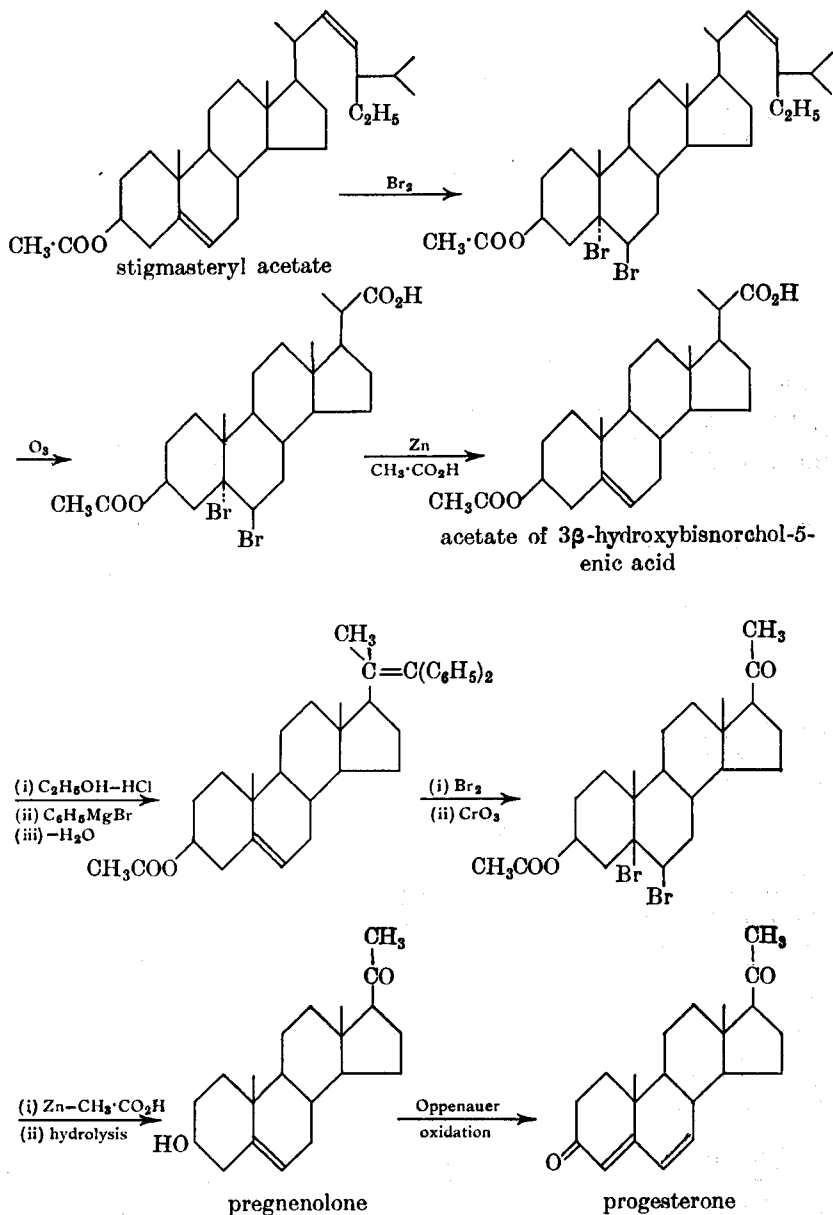

Pregnenolone has also been isolated from the *corpus luteum*.

(ii) *Progesterone from cholesterol* (Butenandt *et al.*, 1939). Cholesterol is first converted into dehydroepiandrosterone (see §13), and then as follows:

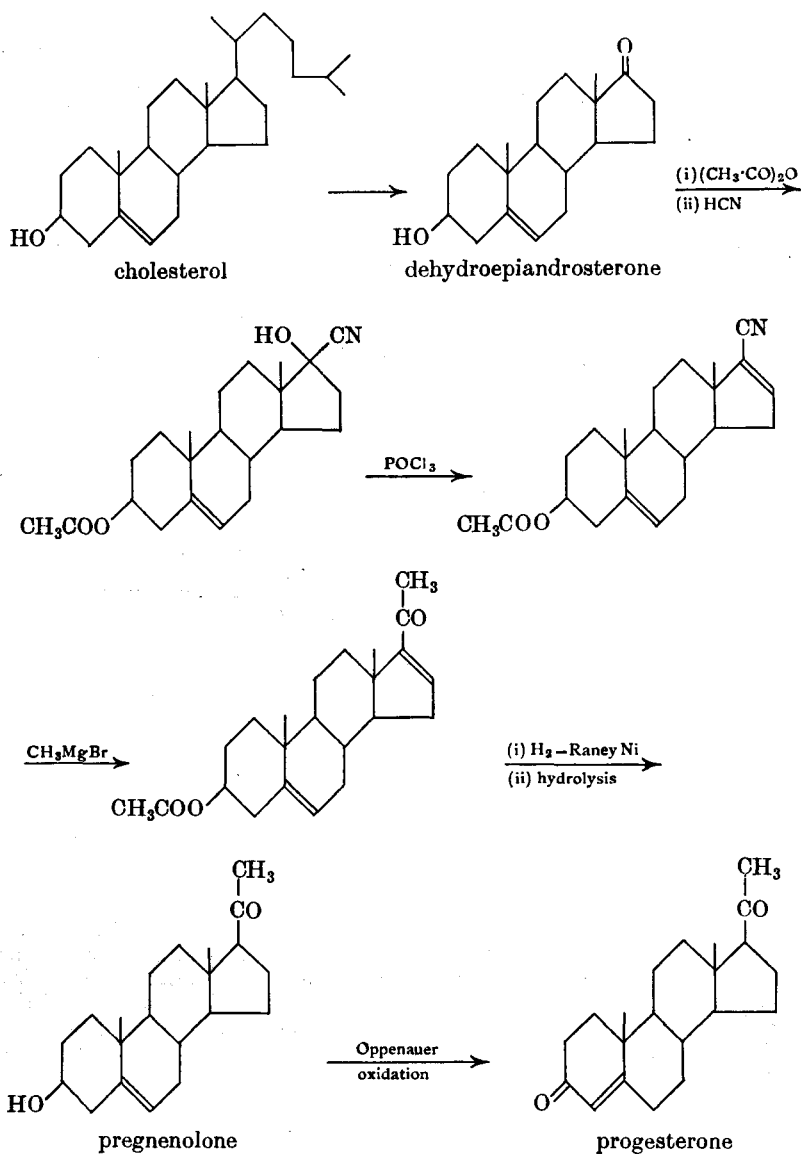

(iii) *Progesterone from diosgenin* (Marker *et al.*, 1940, 1941). Diosgenin (a sapogenin) occurs as a glycoside in the root of *Trillium erectum*.

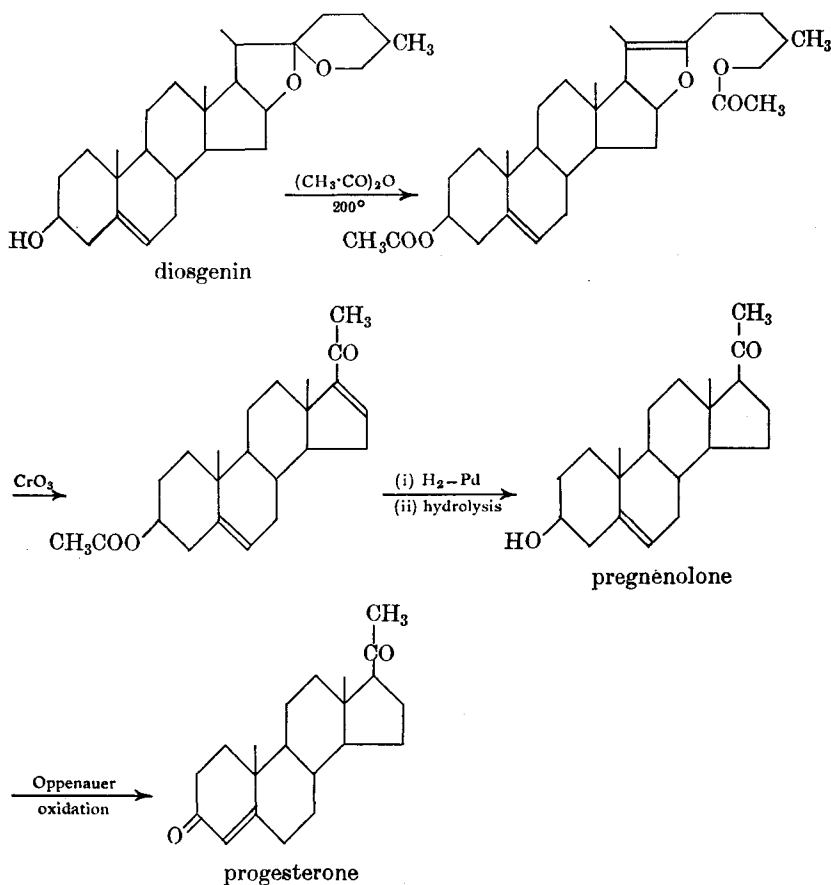

**Saponins and Sapogenins.** Saponins are plant glycosides, and the aglycon is known as the sapogenin (*cf.* §24. VII). Saponins are very powerful emulsifiers, and derive their name from this property; they are used as detergents. There are two groups of saponins, the steroid and the triterpenoid saponins, and these two groups may be distinguished by the fact that only the former group gives Diels' hydrocarbon on distillation with selenium; the triterpenoid group gives mainly naphthalene or picene derivatives (*cf.* §1).

Digitonin is a steroid saponin; it causes hæmolysis of the red blood cells.

(iv) *Progesterone from pregnanediol* (Butenandt *et al.*, 1930).

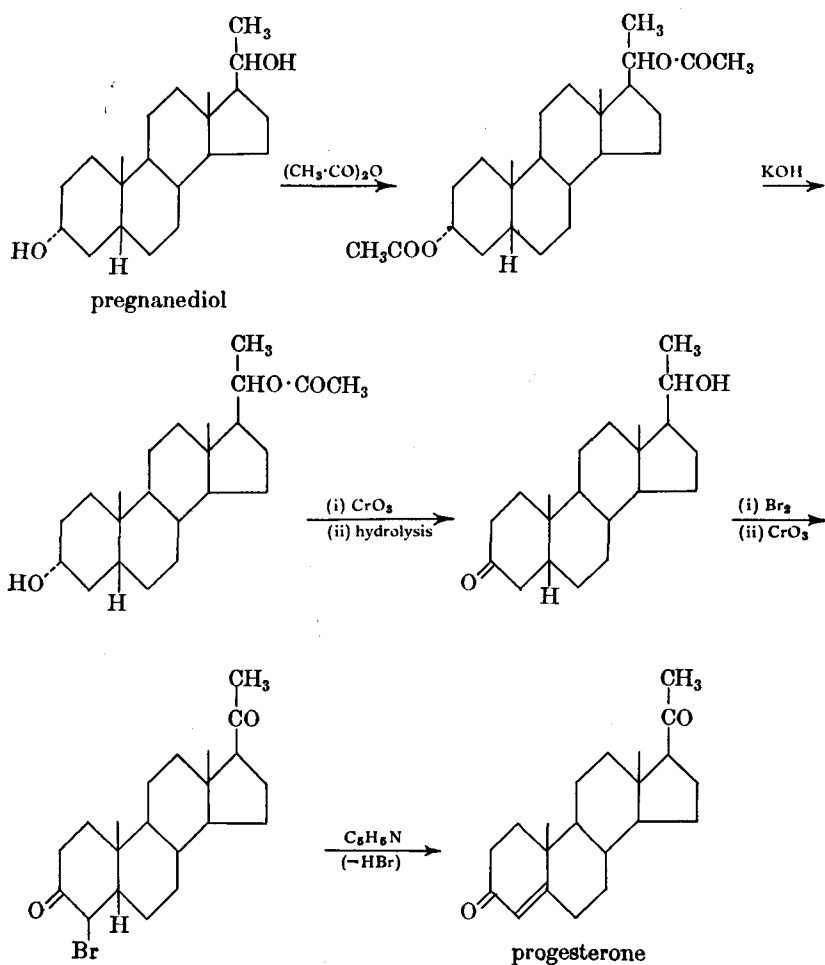

In the above reactions, bromination might have occurred in position 2; in this case the position of the double bond would have been 1 : 2. This is impossible, since the preparation of progesterone by methods (i) to (iii) shows that the double bond must be 4 : 5 or 5 : 6. Thus the preparation from pregnanediol proves that the double bond is 4 : 5.

(v) *Progesterone from ergosterol* (Shepherd *et al.*, 1955). This appears to be the most practical synthesis.

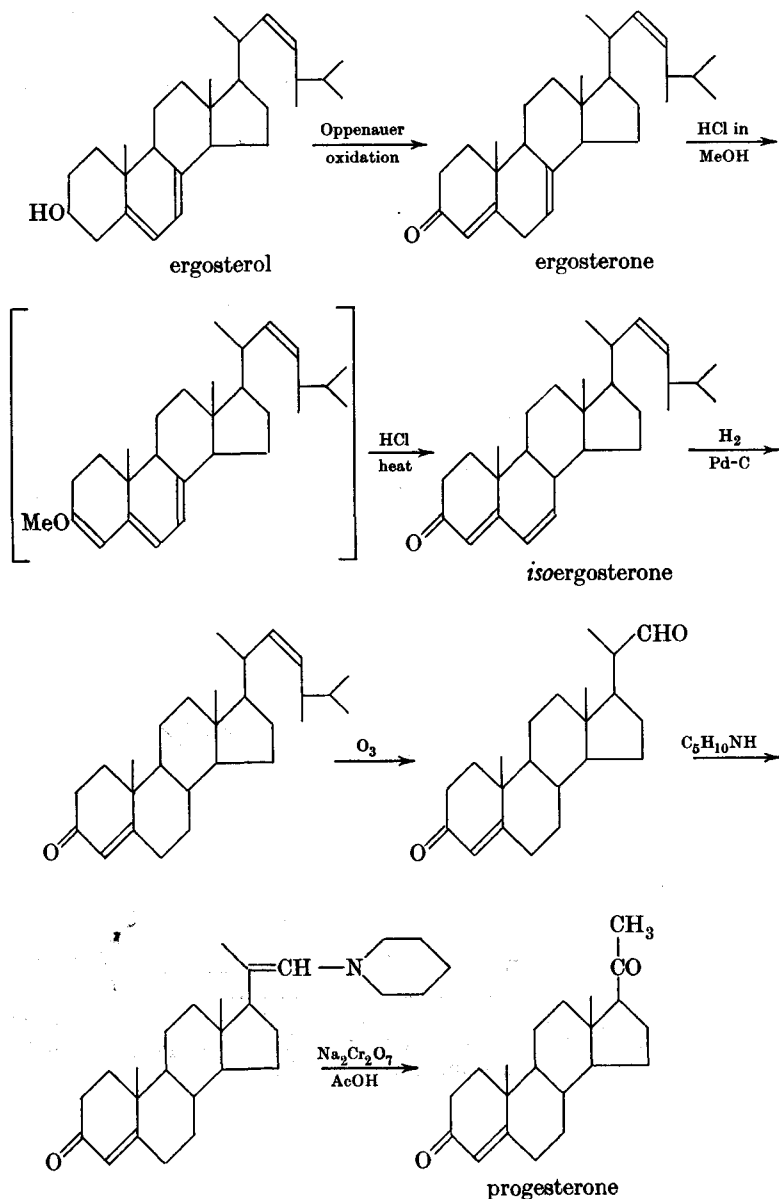

§20. **Pregnane-3 $\alpha$ :20 $\alpha$ -diol**, C<sub>21</sub>H<sub>36</sub>O<sub>2</sub>, was isolated from human pregnancy urine by Marrian (1929); it is biologically inactive, and is the main metabolic product of progesterone. The functional nature of the two oxygen atoms was shown to be secondary alcoholic, and since pregnanediol is saturated, the parent hydrocarbon is C<sub>21</sub>H<sub>36</sub>, and so the molecule is tetracyclic. Pregnanediol gives the haloform reaction; thus a CH<sub>3</sub>·CHOH· group is pre-



sent (see Vol. I). When oxidised, pregnanediol is converted into the diketone pregnanedione and this, on the Clemmensen reduction, forms pregnane,  $C_{21}H_{36}$ . This is identical with 17-ethylætiocolane, a compound of known structure. Thus pregnanediol contains the steroid nucleus, and the position of the side-chain is 17. Finally, the relationship between pregnanediol and progesterone shows that the former contains one hydroxyl group at position 3. Further work showed that the configuration of the 3-hydroxyl group is  $\alpha$ . Thus:

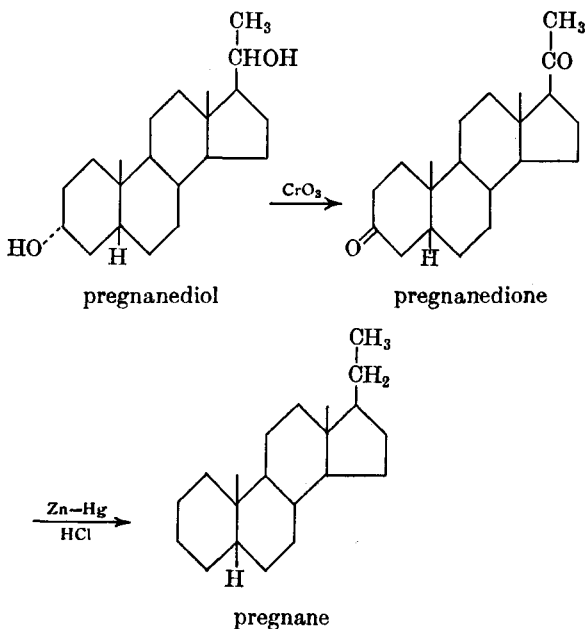

### ADRENAL CORTICAL HORMONES

**§21. Introduction.** In the adrenal glands (of mammals) there are two regions, the *medulla* which produces adrenaline (see §12. XIV), and the *cortex* which produces steroid hormones. The production of these adreno-cortical hormones is controlled by the hormone produced in the anterior lobe of the pituitary, the so-called adrenocorticotrophic hormone, ACTH. The absence of the *corticoids* causes loss of sodium from the body.

**§22. Adrenal cortical hormones.** About 28 steroids have been isolated from the extract of the adrenal cortex, and their structures have been elucidated mainly by Kendall *et al.* (1935), Wintersteiner (1935- ) and Reichstein *et al.* (1936- ). Only six of these 28 compounds are physiologically active, fourteen are inactive and are produced by the reduction of the active hormones, and the remaining six are œstrone, progesterone,  $17\alpha$ -hydroxyprogesterone and adrenosterone, and two other compounds that are apparently produced by oxidation during the isolation of the hormones from the cortical extract. Adrenosterone is as shown, and possesses androgenic activity (see overleaf).

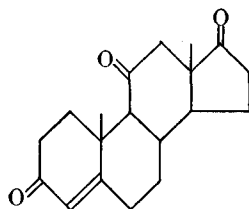

andrenosterone

The six active compounds are as follows (they have been designated by letters as well as named systematically).

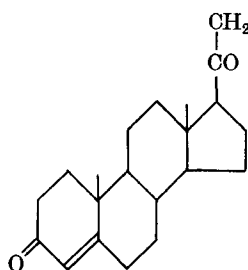

Substance Q;

11-Deoxycorticosterone;  
21-Hydroxyprogesterone

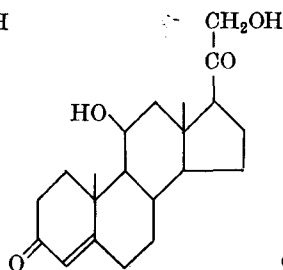

Substance H;

Corticosterone;  
11 : 21-Dihydroxy-  
progesterone

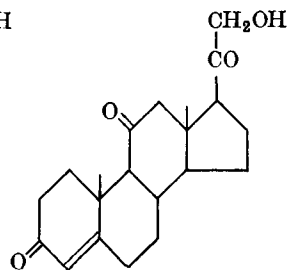

Compound A;

11-Dehydrocorticosterone;  
21-Hydroxy-11-keto-  
progesterone

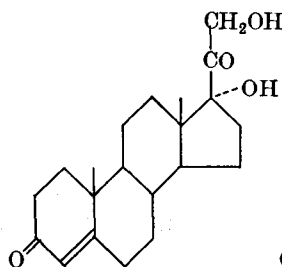

Substance S;

11-Deoxy-17-hydroxy-  
corticosterone

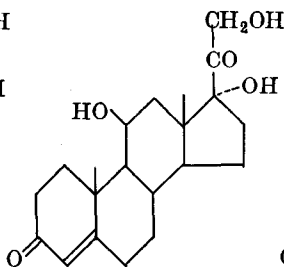

Substance M;

17-Hydroxy-  
corticosterone

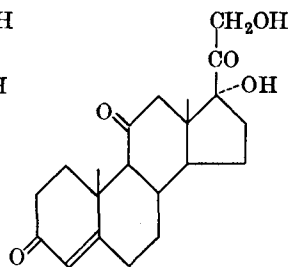

Substance F;

Compound E;  
11-Dehydro-17-hydroxy-  
corticosterone;  
cortisone

Owing to the presence of the  $\alpha$ -hydroxyketone group, the adrenal cortical hormones are strong reducing agents. The hydroxyl group at position 21 behaves in the usual way, but the 11-keto group does not form an oxime or a phenylhydrazone. The 11-keto group is resistant to catalytic reduction in neutral solution, but can be reduced in acid solution; it is readily reduced to a hydroxyl group by lithium aluminium hydride, and to a methylene group by the Clemmensen reduction.

The keto-hormones are separated from non-keto compounds by means of Girard's reagents P and T (see Vol. I).

The structures of the cortical hormones have been elucidated by degrada-

tion and by partial syntheses from sterols of known structure, *e.g.*, deoxycorticosterone from stigmasterol (Reichstein *et al.*, 1937, 1940). The first step is the conversion of stigmasterol to pregnenolone (see §19 i).

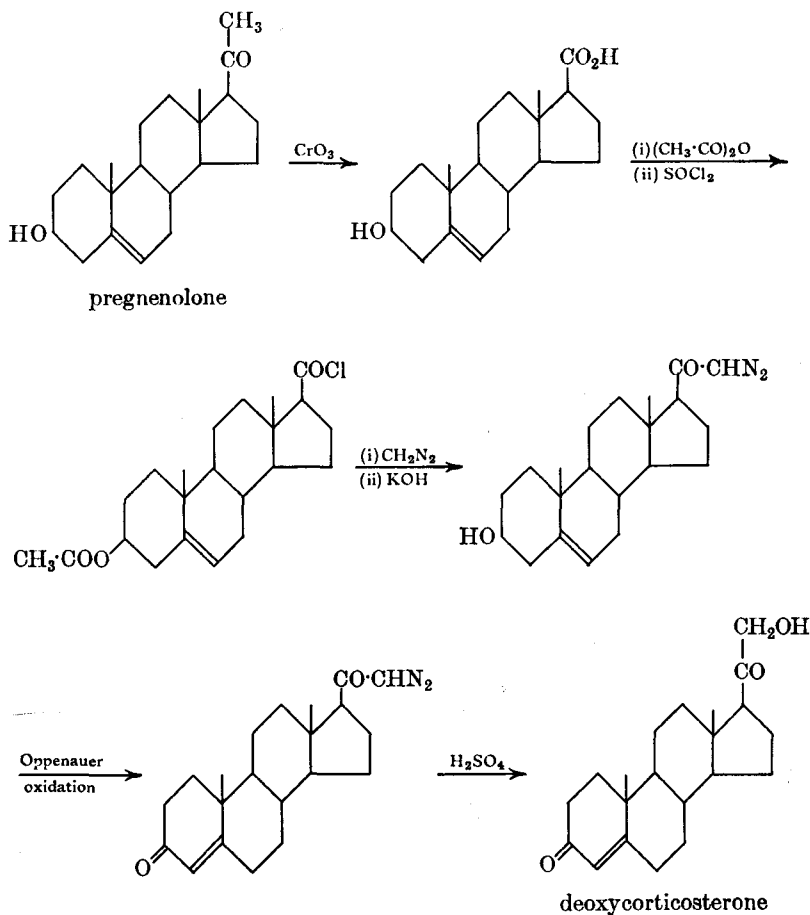

A very interesting point about the above synthesis is the unusual stability of the diazoketone.

**Cortisone** (Substance F, Compound E) has been used for the treatment of rheumatoid arthritis and rheumatic fever. Many partial syntheses are known, and there is also a total synthesis; *e.g.*, the following partial synthesis starts from  $3\alpha : 21$ -diacetylpregnane-11 : 20-dione (Sarett, 1948) (see overleaf).

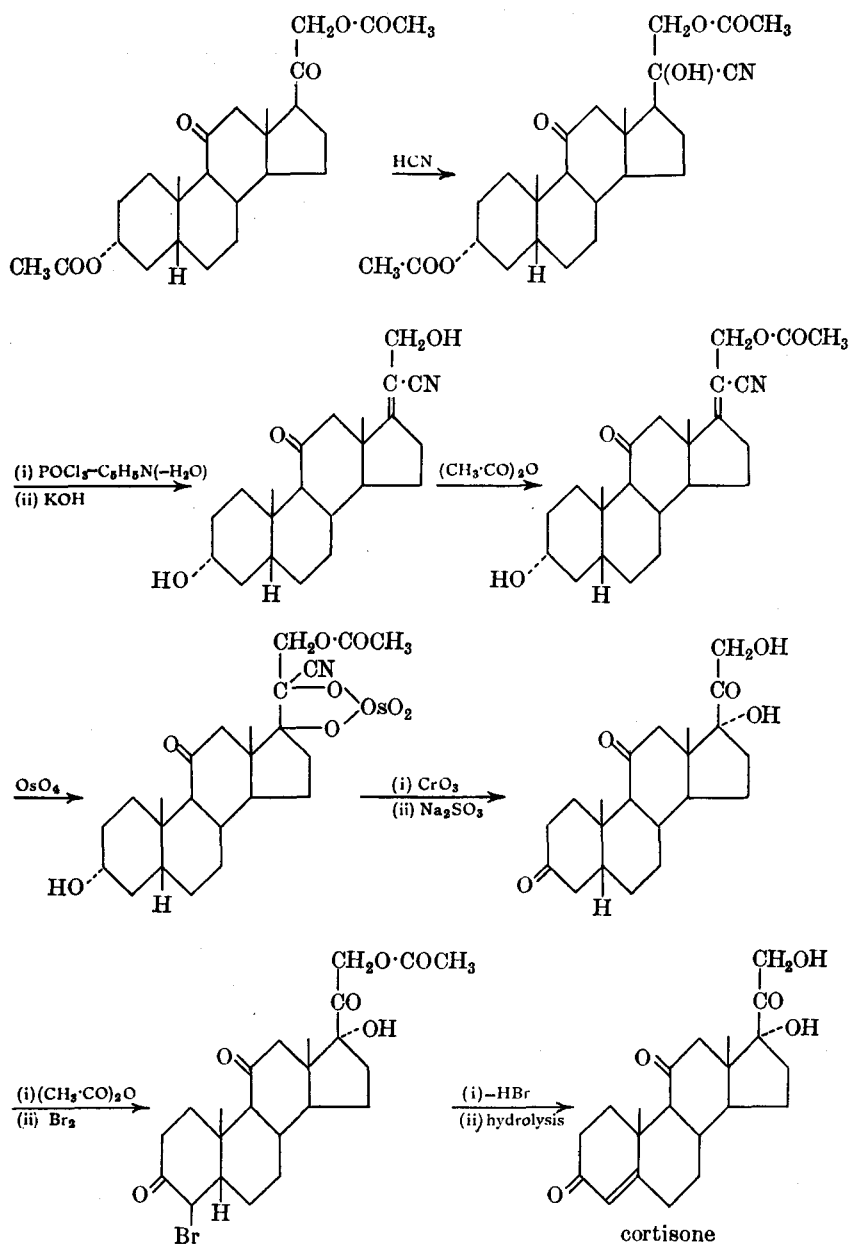

## AUXINS

§23. It had been suggested for some years by botanists that various substances had plant growth-promoting properties, but it was not until 1933 that such compounds were actually isolated. In 1933, Kögl *et al.* isolated an active compound from human urine, and they named it **auxin a** and showed that its structure is I. Soon afterwards, Kögl *et al.* isolated **auxin b** (II) from maize germ oil.

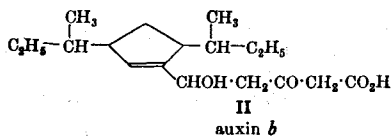
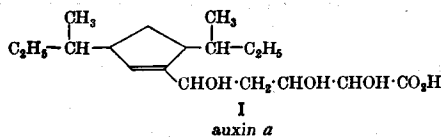

The name **auxin** is now taken as the *generic* name for the plant hormones. Auxins generally occur in the plant kingdom, but are also present in urine, etc. Further work by Kögl *et al.* (1934) led to the isolation from urine of another growth-promoting substance which the authors named "hetero-auxin", and subsequently showed that this compound is indole-3-acetic acid.

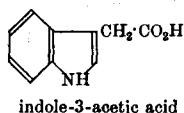

The discovery that indole-3-acetic acid had plant growth-promoting properties led to the examination of compounds of related structure, and it was soon found that various derivatives of indole-3-acetic acid are also very active; it was also found that a number of arylacetic acids and aryloxyacetic acids are active, *e.g.*, phenylacetic acid, III, 1-naphthaleneacetic acid, IV, and 2-naphthoxyacetic acid, V.

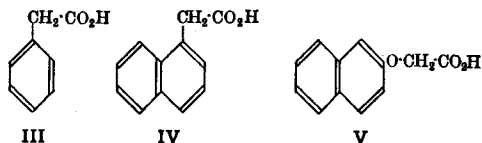

Recent work has suggested that indole-3-acetic acid is the natural plant hormone, and not auxins *a* and *b*. In fact, there now appears to be some doubt as to the existence of auxin *a* (*auxentriolic acid*) and auxin *b* (*auxenolonic acid*); neither of these compounds has been isolated since Kögl obtained them.

The relation between chemical structure and growth-promoting properties has still to be solved, but nevertheless much progress has been made in this direction. Koepli *et al.* (1938) believe that a plant hormone must have a ring structure containing at least one double bond, and a side-chain containing a carboxyl group (or a group capable of being converted into a carboxyl group) removed from the ring by at least one carbon atom (*cf.* compounds I-V). These requirements, however, have been modified by Veldestra (1944-).

#### READING REFERENCES

- Fieser and Fieser, *Steroids*, Reinhold (1959).  
 Gilman (Ed.), *Advanced Organic Chemistry*, Wiley (1943, 2nd ed.). Ch. 19. The Steroids.  
 Rodd (Ed.), *Chemistry of Carbon Compounds*, Elsevier. Vol. IIB (1953). Ch. 17. Sterols and Bile Acids. Ch. 18. Sex Hormones; Adrenocortical Hormones.  
 Stewart and Graham, *Recent Advances in Organic Chemistry*, Longmans, Green. Vol. III (1948, 7th ed.). Ch. I. The Bile Acids and Sterols. Ch. III. The Hormones.  
*Vitamins and Hormones*, Academic Press (Vol. I, 1943-).

- Cook (Ed.), *Progress in Organic Chemistry*, Butterworth. Vol. II (1953). Ch. 4. The Partial Synthesis of Cortisone and Related Compounds from Accessible Steroids. Ch. 5. The Relationship of Natural Steroids to Carcinogenic Aromatic Compounds. Vol. III (1955). Ch. 1. Total Synthesis of Steroids. Vol. 5 (1961). Ch. 4. The Chemistry of the Higher Terpenoids.
- Shoppee, *Chemistry of the Steroids*, Academic Press (1958).
- Klyne, *The Chemistry of the Steroids*, Methuen (1957).
- Lythgoe, Some Recent Advances in the Chemistry of the D-Vitamins, *Proc. Chem. Soc.*, 1959, 141.
- Butenandt, The Windaus Memorial Lecture, *Proc. Chem. Soc.*, 1961, 131.
- Loewenthal, Selective Reactions and Modifications of Functional Groups in Steroid Chemistry, *Tetrahedron*, 1959, 6, 269.
- Handbook for Chemical Society Authors*, Chem. Soc. (1960). Ch. 4. Nomenclature of Steroids.
- Dodds, Synthetic Estrogens, *J. Pharm. Pharmacol.*, 1949, 1, 137.
- Wicker, The Mechanism of Catalytic Hydrogenation of Cyclic Compounds, *J.C.S.*, 1956, 2165.
- Popják, Chemistry, Biochemistry and Isotopic Tracer Technique, Royal Institute of Chemistry Monograph, No. 2 (1955).
- Ciba Foundation Symposium on the Biosynthesis of Terpenes and Sterols, Churchill (1959).
- Skoog (Ed.), *Plant Growth Substances*, University of Wisconsin (1951).
- Pincus and Thimann (Ed.), *The Hormones*, Academic Press. Vol. I (1948). Plant Growth Hormones (p. 5).
- Audus, *Plant Growth Substances*, Leonard Hill Ltd. (1953).

CHAPTER XII  
HETEROCYCLIC COMPOUNDS CONTAINING  
TWO OR MORE HETERO-ATOMS

§1. **Nomenclature.** (i) When the heterocyclic compound contains two or more hetero-atoms, the starting point for numbering is the hetero-atom of as high a group in the periodic table and as low an atomic number in that group. Thus the order of naming will be O, S, Se, N, P, As, Sb, Si, Sn, Pb, Hg.

(ii) With the atom of the preferred kind as number 1, the ring is numbered in such a way that the hetero-atoms are given the lowest numbers possible.

(iii) Of two or more numberings conforming to rules (i) and (ii), the one that is chosen is that which assigns low numbers more nearly in the order of precedence established by rule (i).

(iv) Of two or more numberings conforming to rules (i)–(iii), the one that is chosen is that which gives hydrogen atoms the lowest numbers possible.

(v) When a heterocyclic compound containing at least one nitrogen atom does not end in *ine* and gives *basic* compounds on progressive hydrogenation, the latter derivatives will be indicated by the successive endings *ine*, *idine*; e.g., pyrazole, pyrazoline, pyrazolidine.

The hetero-atoms in heterocyclic compounds are indicated by prefixes, e.g., **O** by **oxa**, **S** by **thia**, **N** by **aza**.

AZOLES

*Azole* is the suffix used for five-membered rings containing two or more hetero-atoms, at least one of which is nitrogen.

PYRAZOLE GROUP

§2. **Pyrazole.** Pyrazole may be synthesised in a number of ways, some of the more convenient methods being the following:

(i) By passing acetylene into a cold ethereal solution of diazomethane (von Pechmann, 1898).

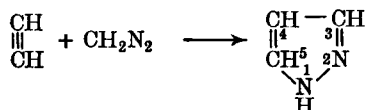

(ii) By heating epichlorohydrin with hydrazine in the presence of zinc chloride (Balbiano, 1890).

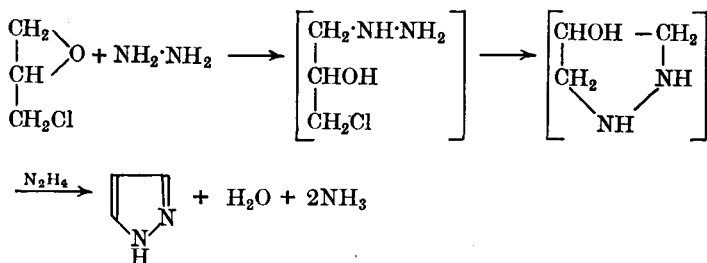

(iii) By the decarboxylation of various pyrazolecarboxylic acids, *e.g.*, by heating pyrazole-3 : 4 : 5-tricarboxylic acid (see also §2a ii).

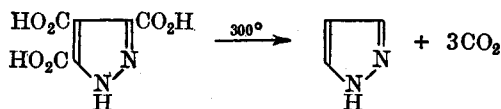

(iv) Jones (1949) has shown that pyrazole may be conveniently prepared by the condensation of 1 : 1 : 3 : 3-tetraethoxypropane,

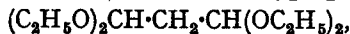

with hydrazine dihydrochloride.

**Properties of pyrazole.** Pyrazole is a colourless solid, m.p. 70°. It is a tautomeric substance; the existence of tautomerism cannot be demonstrated in pyrazole itself, but it can be inferred by the consideration of pyrazole derivatives. If pyrazole is tautomeric, then the positions 3 and 5 will be identical; if pyrazole is not tautomeric, then these positions are different. Now Knorr *et al.* (1893) showed that on oxidation, both 3-methyl-1-phenylpyrazole and 5-methyl-1-phenylpyrazole gave the *same* product, *viz.*, methylpyrazole. Thus positions 3 and 5 must be equivalent in pyrazole, and this

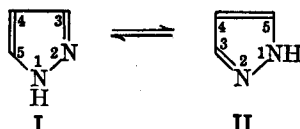

can only be explained by assuming that pyrazole is tautomeric (I and II). It therefore follows that in pyrazole there can only be *two* carbon-alkyl derivatives, 3- (or 5-) and 4-. If, however, the imino hydrogen is replaced by an alkyl or aryl group, then *three* carbon-alkyl derivatives are possible, 3, 4 and 5, since tautomerism is now impossible, and so positions 3 and 5 are no longer equivalent.

Pyrazole exhibits aromatic properties, *e.g.*, it is readily halogenated, nitrated and sulphonated; the group enters at position 4. The following resonating structures are possible for pyrazole.

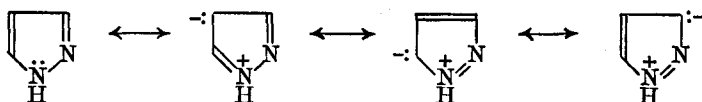

If these structures are contributed equally, then electrophilic attack should occur equally well at positions 3, 4 or 5 (in pyrazole itself, positions 3 and 5 are equivalent). As we have seen above, electrophilic attack occurs exclusively at position 4. The reason for this is not certain. Possibly the resonating structures are not contributed equally (as was assumed). On the other hand, Dewar (1949) has suggested that substitution occurs in the 4-position because the transition state for 4-substitution is more symmetrical,

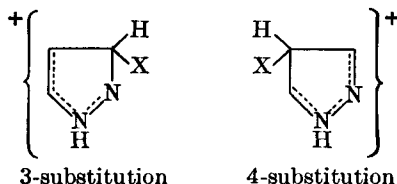

and consequently more stable, than the transition state for 3- (or 5-) sub-



stitution. Orgel *et al.* (1951), however, have calculated the electron distribution in pyrazole, and it can be seen from their results that 4-substitution will be favoured by electrophilic reagents. Brown (1955, 1960) has also calculated the electron densities in pyrazole.

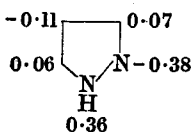

It is interesting to note that pyrazole-4-diazonium salts are stable to boiling water. Pyrazole is feebly basic, and forms salts with inorganic acids; the imino hydrogen may be replaced by an acyl group. Pyrazole is very resistant to oxidising and reducing agents, but may be hydrogenated catalytically, first to pyrazoline, and then to pyrazolidine. Both of these compounds are stronger bases than pyrazole.

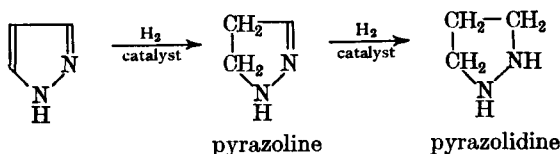

### §2a. Synthesis of pyrazole derivatives.

(i) A very important method for preparing pyrazole derivatives is by the reaction between  $\beta$ -diketones (or  $\beta$ -ketoaldehydes) and hydrazines (Knorr *et al.*, 1883).

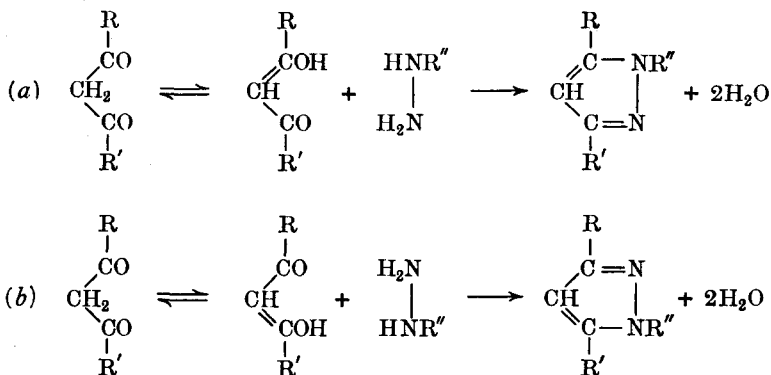

Thus, according to the above, a mixture of isomeric pyrazoles will be produced. Contrary to general opinion, the product is usually only one of the isomers, *e.g.*, benzoylacetone and phenylhydrazine form only 3-methyl-1:5-diphenylpyrazole (Drumm, 1931).

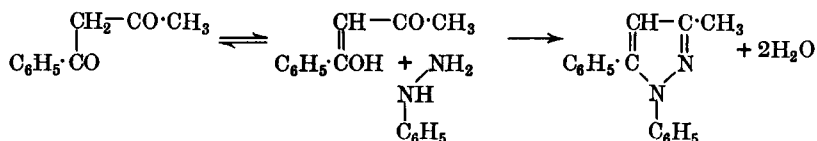

In a few cases, two isomers have been isolated, *e.g.*, 3- $\alpha$ -benzoylacetyl-1:5-diphenylpyrazole, I, reacts with phenylhydrazine to produce a mixture of 1:1':5:5'-tetraphenyl-3:3'-dipyrazolyl, II, and 1:1':3':5-tetraphenyl-3:5'-dipyrazolyl, III (Finar, 1955).

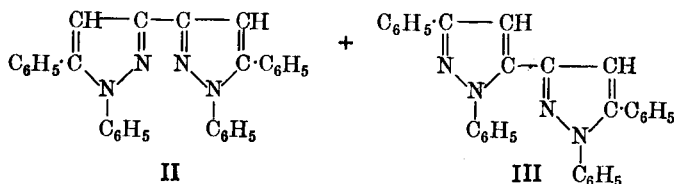
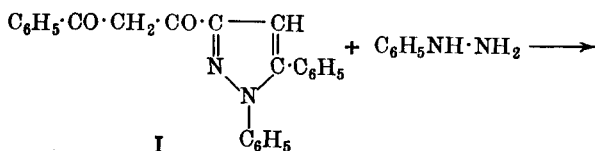

If  $\beta$ -ketoesters are used instead of  $\beta$ -diketones, then 5-pyrazolones are formed (Knorr *et al.*, 1883), *e.g.*, ethyl acetoacetate reacts with hydrazine to form 3-methylpyrazol-5-one.

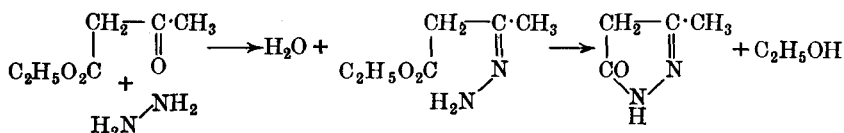

(ii) Pyrazolecarboxylic acids are produced by the reaction between diazoacetic ester and acetylenic compounds, *e.g.*, with ethyl acetylenedicarboxylate, ethyl pyrazole-3 : 4 : 5-tricarboxylate is formed.

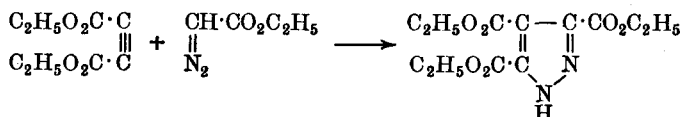

If an ethylenic compound is used instead of an acetylenic one, then a pyrazoline derivative is produced, *e.g.*, ethyl fumarate gives ethyl pyrazoline-3 : 4 : 5-tricarboxylate.

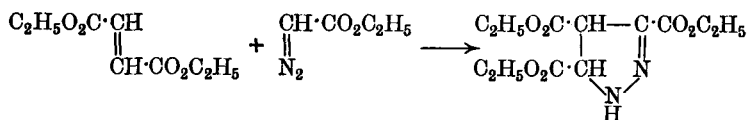

(iii) Pyrazoles are produced by the reaction between acetylenic carbonyl compounds and hydrazines (Moureu *et al.*, 1903); a mixture of isomers is said to be obtained.

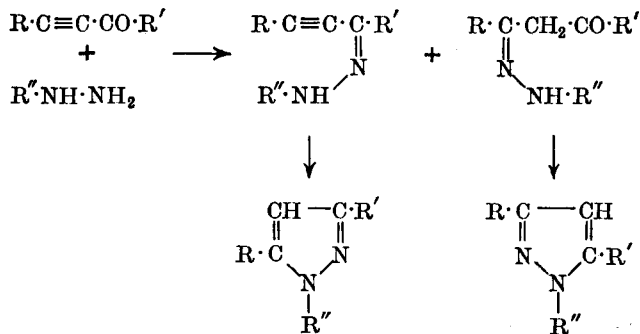

(iv) Pyrazolines are obtained by the condensation of  $\alpha : \beta$ -unsaturated ketones or aldehydes with hydrazines, *e.g.*, acraldehyde and hydrazine give pyrazoline.

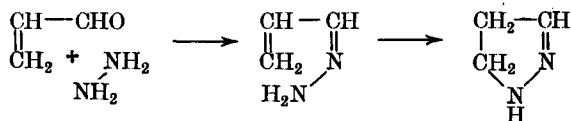

Pyrazolines may be oxidised to pyrazoles by bromine or mercuric oxide.

**Properties of the pyrazole derivatives.** Pyrazoles with substituent methyl groups may be oxidised by potassium permanganate to the corresponding pyrazolecarboxylic acids, *e.g.*,

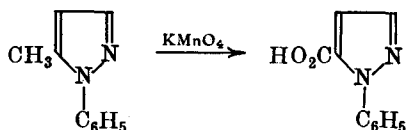

Pyrazole-3- and 5-carboxylic acids are readily decarboxylated by heating above their melting points; the pyrazole-4-carboxylic acids are more stable, but can nevertheless be decarboxylated at elevated temperatures, *e.g.*,

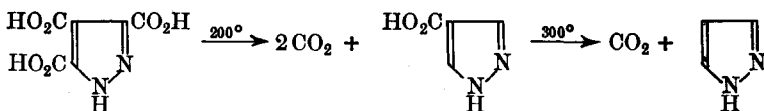

Although pyrazole itself is not reduced by sodium and ethanol, *N*-phenyl substituted pyrazoles are readily reduced to the corresponding pyrazolines, *e.g.*,

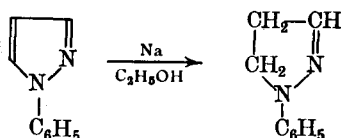

1-Unsubstituted pyrazoles apparently cannot be chloromethylated; carbinols are produced, *e.g.* (Dvoretzky *et al.*, 1950):

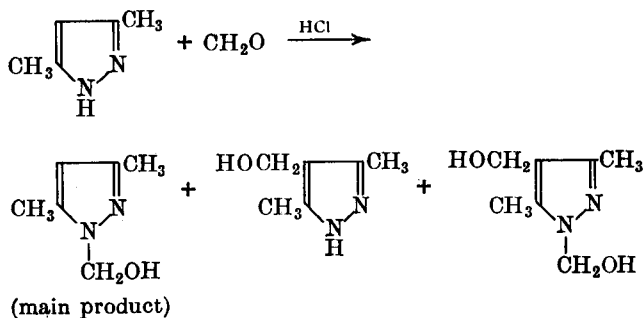

On the other hand, 1-phenylpyrazole can readily be chloromethylated in the 4-position (Finar *et al.*, 1954).

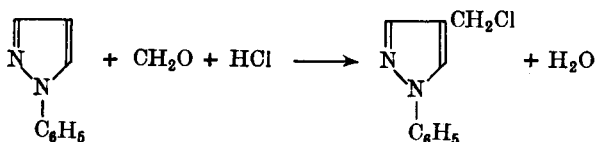

4-Chloromethyl-1-phenylpyrazole can be converted into 1-phenylpyrazole-4-aldehyde by means of the Sommelet reaction (see Vol. I). The 4-aldehyde is more conveniently prepared by the direct formylation of 1-phenylpyrazole with dimethylformamide and phosphoryl chloride (Finar *et al.*, 1957). 1-Phenylpyrazole can also be mercurated in the 4-position (Finar *et al.*, 1954).

When boiled with concentrated aqueous potassium hydroxide, quaternary pyrazoles are converted into hydrazines (Knorr *et al.*, 1906), *e.g.*,

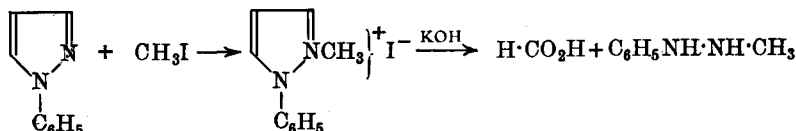

Knorr used this reaction to prepare *sym.*-disubstituted hydrazines; at the same time, this reaction proves the structure of the pyrazole-quaternary salts.

Esters of the pyrazolinecarboxylic acids eliminate nitrogen on heating to give cyclopropane derivatives; sometimes much better results are achieved if the compound is heated with copper powder.

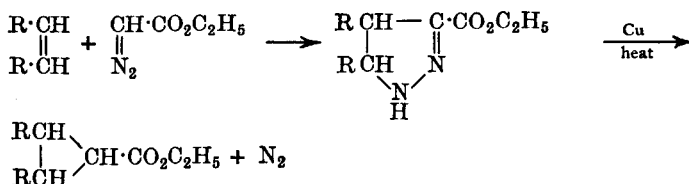

**Antipyrene** (2:3-dimethyl-1-phenylpyrazol-5-one), m.p. 127°, is very much used in medicine as a febrifuge. It is prepared industrially by condensing ethyl acetoacetate with phenylhydrazine, and methylating the product, 3-methyl-1-phenylpyrazole-5-one, with methyl iodide in alkaline ethanolic solution, or with methyl sulphate in the presence of sodium hydroxide.

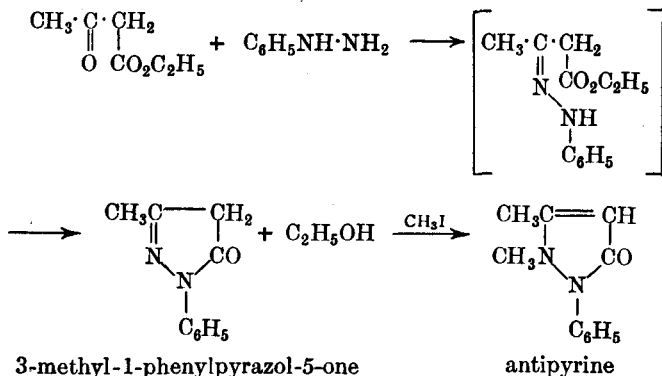

At first sight one might have expected to obtain the *O*-methyl or the 4-methyl derivative, since the tautomeric forms IV (keto) and V (enol) are theoretically

possible. Methylation of 3-methyl-1-phenylpyrazole-5-one with diazomethane results in the formation of the *O*-methyl derivative (this is also

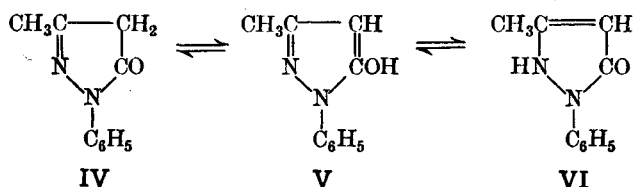

produced in a small amount when methyl iodide is used as the methylating reagent). This raised some doubts as to the structure of antipyrine, since for its formation, the tautomeric form VI must also be postulated. The structure of antipyrine was shown to be that given above by its synthesis from *sym.*-methylphenylhydrazine and ethyl acetoacetate.

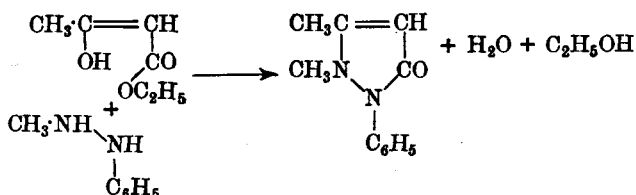

The pyrazole nucleus has always been considered to be a synthetic one, but Fowden *et al.* (1959) have now isolated  $\alpha$ -amino- $\beta$ -1-pyrazolylpropionic acid from water-melon seed; this acid has been synthesised in good yield by Finar *et al.* (1960).

**§2b. Indazoles (benzopyrazoles).** Indazole may be prepared by the removal of a molecule of water from *o*-toluenediazohydroxide in neutral solution (the yield is very poor).

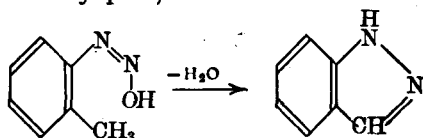

Indazole may conveniently be prepared by heating *o*-*N*-nitroso-*N*-benzoyl-toluidine in benzene solution.

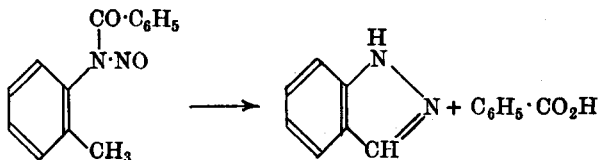

Indazole, m.p. 146°, exhibits the same type of tautomerism that exists in pyrazole, since *two* series of *N*-derivatives (1 and 2) are known:

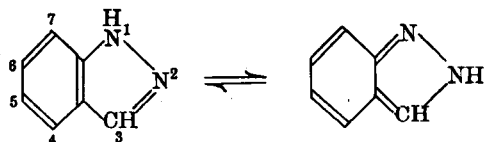

Nitration and sulphonation of indazole produce the 5-substitution product; bromination gives the 3 : 5-dibromo compound.

## IMIDAZOLE GROUP

This group of compounds is also known as the *iminazoles* or the *glyoxalines*.

§3. **Imidazole (iminazole, glyoxaline)** is isomeric with pyrazole, and occurs in the purine nucleus and in the amino-acid histidine; 4-aminoimidazole-5-carboxamide occurs naturally as a riboside (or ribotide).

Imidazole may be prepared by the action of ammonia on glyoxal. The mechanism of this reaction is uncertain, but one suggestion is that one molecule of glyoxal breaks down into formic acid and formaldehyde, and then the latter reacts as follows:

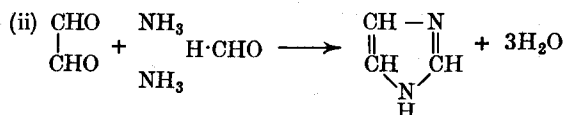

A certain amount of support for this mechanism is given by the fact that glyoxaline may be prepared directly from glyoxal, ammonia and formaldehyde.

A general method for preparing imidazoles is by the reaction between an  $\alpha$ -dicarbonyl compound, ammonia and an aldehyde (Radziszewsky, 1882).

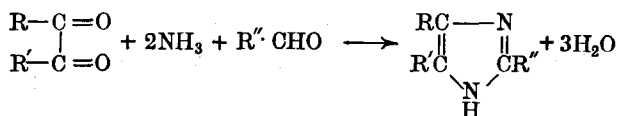

Imidazole itself is best prepared by the action of ammonia on a mixture of formaldehyde and tartaric acid dinitrate ("dinitrotartaric acid"), and then heating the dicarboxylic acid thereby produced.

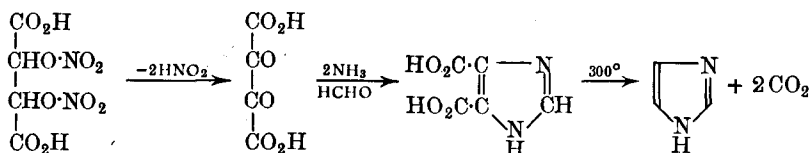

Another good method is to brominate paraldehyde in ethylene glycol and to heat the product, 2-bromomethyl-1:3-dioxalan, with formamide in the presence of ammonia (Bredereck *et al.*, 1958); bromoacetaldehyde is probably an intermediate:

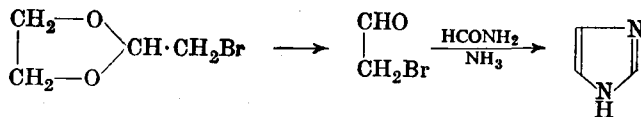

Imidazole, m.p.  $90^\circ$ , is a weak base, but it is more basic than pyrazole. Imidazole is a tautomeric substance, since positions 4 and 5 are equivalent (positions 5, 4 and 2 have also been designated  $\alpha$ ,  $\beta$  and  $\mu$ , respectively).

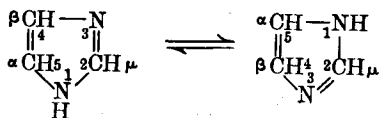

Methyl iodide attacks imidazole in potassium hydroxide solution to form 1-methylimidazole which, when strongly heated, isomerises to 2-methylimidazole (*cf.* the Hofmann rearrangement; see Vol. I).

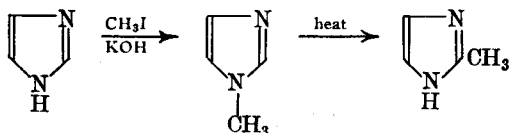

An interesting method of preparing 4(5)-methylimidazole is by the action of zinc hydroxide and ammonia on glucose; the reaction is assumed to occur *via* the breakdown of glucose into methylglyoxal and formaldehyde, which then react as follows:

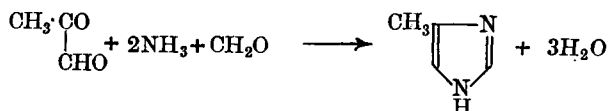

The imidazole ring is extremely stable towards oxidising and reducing agents; hydrogen peroxide, however, readily opens the ring to form oxamide.

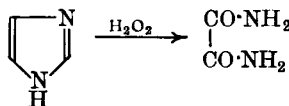

Acetyl chloride and acetic anhydride have no action on imidazole, but benzoyl chloride in the presence of sodium hydroxide *opens* the ring to form dibenzoyldiaminoethylene.

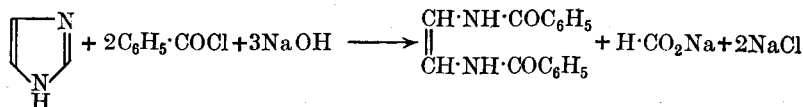

Nitration and sulphonation of imidazole produce the 4(5)-derivative. Electrophilic attack at positions 4 or 5 can be accounted for by the contributions of the resonating structures II and IV. Resonating structure III

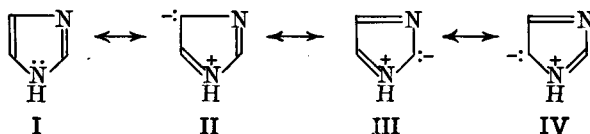

shows that position 2 should also be subject to electrophilic attack. This is found to be the case with halogenation, *e.g.*, bromine reacts with imidazole in chloroform solution to give 2:4:5-tribromoimidazole.

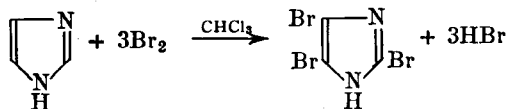

Imidazole couples with diazonium salts in the 2-position, but *N*-alkylimidazoles do not couple at all.

**§3a. Benzimidazoles (benzimidazoles).** These are readily formed by heating *o*-phenylenediamines with carboxylic acids, *e.g.*, benzimidazole itself

(m.p. 170°) is produced by heating *o*-phenylenediamine with 90 per cent. formic acid.

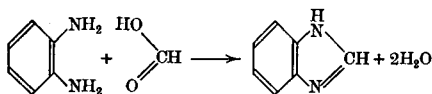

#### OXAZOLE GROUP

§4. *iso*-Oxazoles. *iso*-Oxazoles are formed by the dehydration of the monoximes of  $\beta$ -diketones or  $\beta$ -ketoaldehydes.

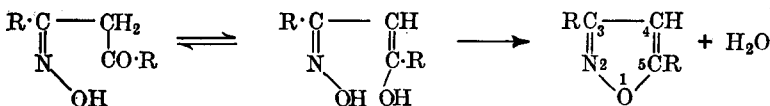

*iso*-Oxazole itself may be prepared by the action of hydroxylamine on propargylaldehyde.

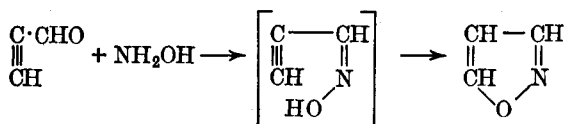

*iso*-Oxazole is a colourless liquid, b.p. 96°, and smells like pyridine; it is weakly basic. *iso*-Oxazoles, when substituted in the 3:5-positions, are stable to alkalis, but when the 3-position is vacant, the ring is opened to form ketonitriles (*cf.* oximes, §§2f, 2g. VI).

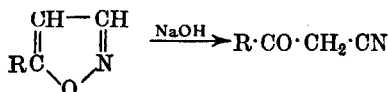

§4a. Oxazoles. Oxazoles may be prepared by the condensation of acid amides with  $\alpha$ -halogenoketones, *e.g.*, acetamide and  $\omega$ -bromoacetophenone form 2-methyl-4-phenyloxazole; the mechanism of the reaction is not certain but it may occur through the enol forms.

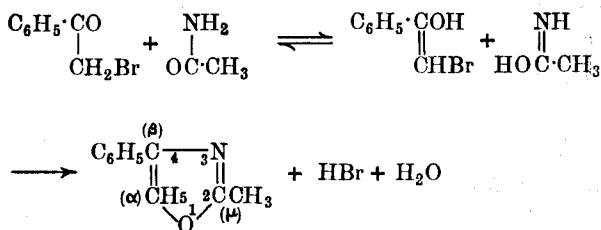

A better method of preparation is the dehydration of  $\alpha$ -acylamidocarbonyl compounds with sulphuric acid or phosphorus pentachloride.

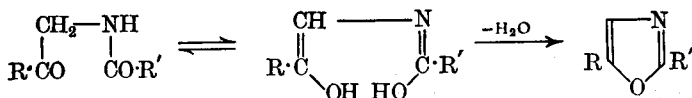

Oxazoles have basic properties similar to those of pyridine, but are less resistant to oxidation. They possess aromatic properties, and the stability of the ring towards hydrolytic reagents depends on the nature of the sub-



stituents in the ring (*cf. iso-oxazoles*). The parent compound, oxazole, has not yet been prepared.

**5-Oxazolones.** The oxazolones are keto derivatives of the oxazolines, the most important group being the 5-oxazolones or **azlactones**. These azlactones are very important intermediates in the preparation of  $\alpha$ -amino-acids (see §2 *va.* XIII) and keto-acids (see Vol. I).

**§4b. Benzoxazoles.** These may be prepared by the reaction between *o*-amino-phenols and carboxylic acids, *e.g.*, *o*-aminophenol and formic acid form benzoxazole, m.p. 31°.

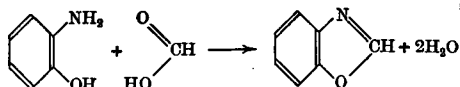

### THIAZOLE GROUP

**§5. Thiazoles.** A general method for preparing thiazoles is the condensation between  $\alpha$ -halogenocarbonyl compounds (particularly the chloro derivatives) and thioamides; the mechanism of the reaction is uncertain, but it may occur through the enol forms.

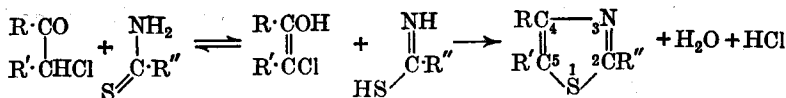

Thiazole itself may be prepared from chloroacetaldehyde and thioformamide.

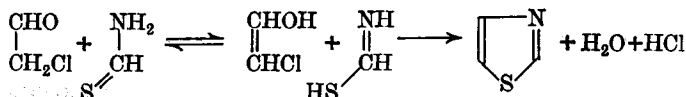

If thiourea or its substitution products are used instead of thioamides, then 2-aminothiazoles are produced, *e.g.*, thiazole may be prepared from chloroacetaldehyde and thiourea as follows:

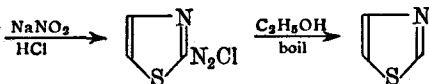
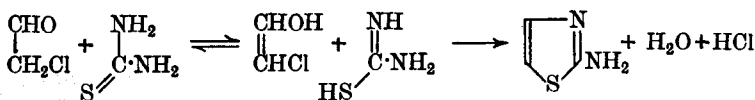

Another general method for preparing thiazoles is by the action of phosphorus pentasulphide on  $\alpha$ -acylamidocarbonyl compounds.

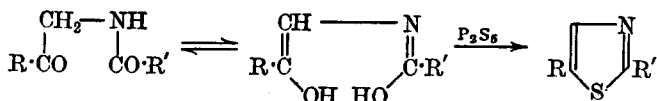

2-Mercaptothiazoles may be prepared by the condensation between  $\alpha$ -chloro-ketones and ammonium dithiocarbamate.

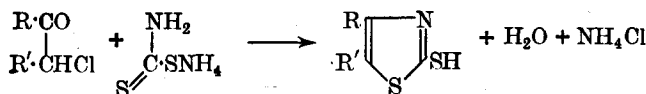

**Thiazole** is a weakly basic liquid, b.p. 117°; it occurs in vitamin B<sub>1</sub>. It is a very stable compound, and is not affected by the usual reducing agents; sodium and ethanol, however, open the ring to form thiols (or hydrogen sulphide) and amines. Thiazole is very resistant to substitution reactions, but if a hydroxyl group or an amino group is in position 2, then the molecule is readily attacked by the usual electrophilic reagents to form 5-substitution products, *e.g.*, 2-hydroxy-4-methylthiazole is readily brominated in chloroform solution to give 5-bromo-2-hydroxy-4-methylthiazole.

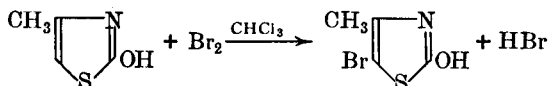

**§5a. Thiazolines.** These may be prepared by the reaction between  $\beta$ -halogenoamines and thioamides, *e.g.*,

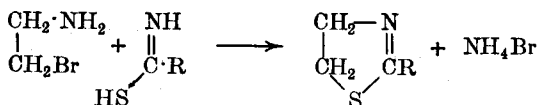

A characteristic reaction of the thiazoles is their ring opening by the action of acids, *e.g.*,

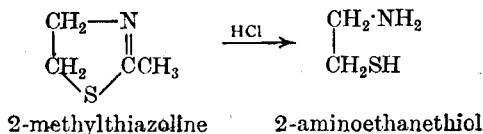

**§5b. Thiazolidines.** These are readily formed by the condensation of carbonyl compounds with cysteine.

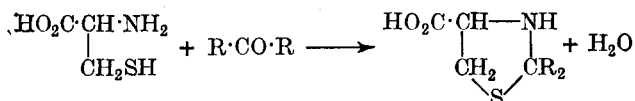

The thiazolidine ring is very easily opened, sometimes by boiling with water, or with an aqueous solution of mercuric chloride (see also penicillin, §6a. XVIII).

**§5c. Benzothiazoles.** These may be prepared by the action of acid anhydrides or chlorides on *o*-aminothiophenols, *e.g.*, benzothiazole from *o*-aminothiophenol and formic acid in the presence of acetic anhydride.

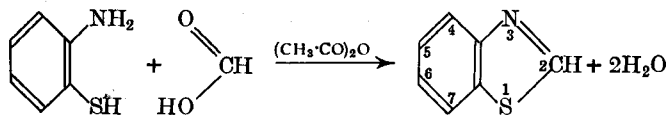

Benzothiazoles are also formed by the action of phosphorus pentasulphide on *o*-acylamidophenols, *e.g.*,

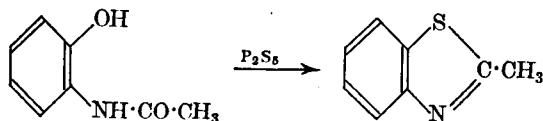

2-Mercaptobenzothiazole is a vulcanisation accelerator (§33a. VIII); it may be prepared as follows:

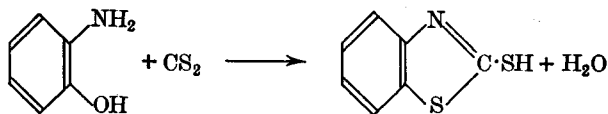

§5d. *iso*Thiazoles. Benzisothiazoles have been known for many years, but no derivatives of *isothiazole* itself have been obtained until very recently when Adams *et al.* (1956) prepared the parent compound and a number of its simple derivatives, *e.g.*,

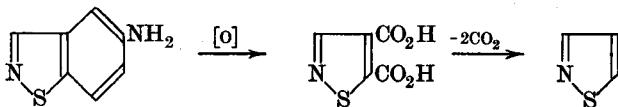

*iso*Thiazole is a colourless liquid which smells like pyridine.

### TRIAZOLE GROUP

§6. *Osotriazoles* and *triazoles*. Triazoles are five-membered rings which contain two carbon and three nitrogen atoms. Two structural isomeric triazoles are known, the 1 : 2 : 3-(1 : 2 : 5-) and the 1 : 2 : 4- (1 : 3 : 4-), the former being known as *osotriazole*, and the latter as *triazole*. Each exists in two dissimilar tautomeric forms.

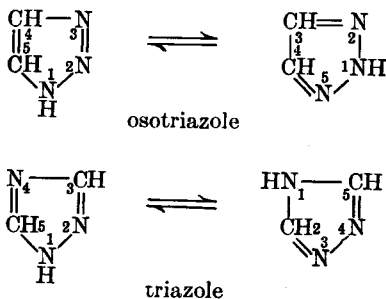

Replacement of the imino hydrogen atom by an alkyl or aryl group prevents tautomerism, and thereby gives rise to the possibility of *two N*-substituted triazoles and *two N*-substituted osotriazoles. All four types of compounds have been prepared.

*Osotriazole* may be prepared by the reaction between acetylene and hydrazoic acid.

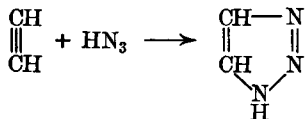

On the other hand, a general method for preparing osotriazoles is the condensation of azides with  $\beta$ -ketoesters, *e.g.*, phenyl azide and ethyl acetate form ethyl 5-methyl-1-phenylosotriazole-4-carboxylate.

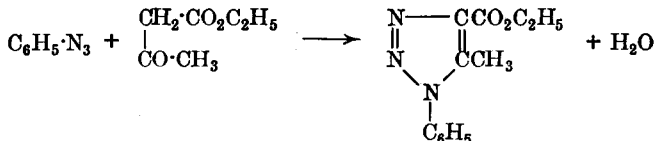

Derivatives of osotriazole may also be prepared by the oxidation of osazones with dichromate and sulphuric acid, or with dilute copper sulphate solution, *e.g.*, benzilosazone gives 1 : 3 : 4-triphenylosotriazole.

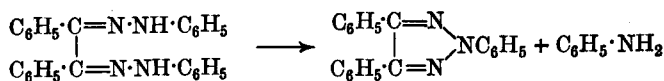

The formation of osotriazoles from sugar osazones provides a good derivative for the characterisation of sugars (see Vol. I).

**Triazoles** may be prepared by heating acid hydrazides with amides, *e.g.*, formyl hydrazide and formamide give triazole.



Triazoles are also formed when *sym.*-diacylhydrazines are heated with ammonia or amines in the presence of zinc chloride, *e.g.*, *sym.*-diacetylhydrazine and methylamine give 1 : 2 : 5-trimethyltriazole.

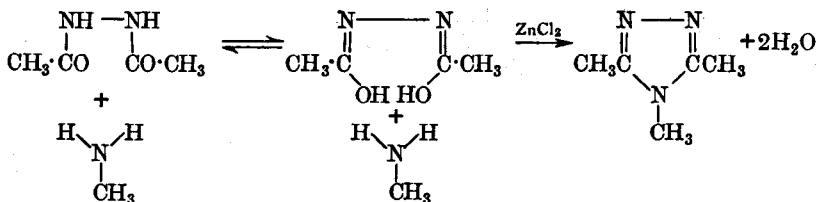

Both triazoles are weak bases, and are very stable compounds.

**Benzotriazole** is formed by the action of nitrous acid on *o*-phenylenediamine.

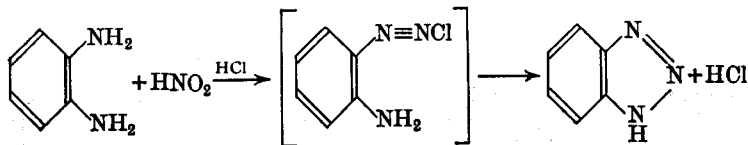

**§7. Oxadiazoles.** These are five-membered rings containing two carbon and two nitrogen atoms and one oxygen atom; four types are known.

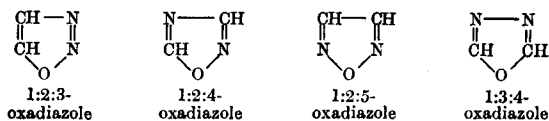

The **furazans** (1 : 2 : 5-oxadiazoles) may be prepared by the action of sodium hydroxide on the dioximes of  $\alpha$ -diketones.

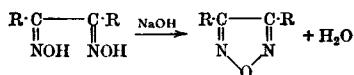

**§8. Sydnones.** The sydnones were first prepared by Earl *et al.* (1935) by the action of cold acetic anhydride on *N*-nitroso-*N*-phenylglycines;

Earl formulated the reaction as follows:

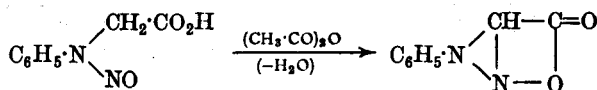

Earl (1946) proposed the name *sydnone* for compounds of this type; thus the above compound is *N*-phenylsydnone.

Sydnones are white or pale yellow crystalline compounds, which are hydrolysed by hot 5 per cent. sodium hydroxide to the original *N*-nitroso-*N*-arylglycine, and by moderately concentrated hydrochloric acid to an arylhydrazine, formic acid and carbon dioxide.

The structure proposed by Earl is similar to that of a  $\beta$ -lactone, but Baker *et al.* (1946, 1949) offered a number of objections to this structure, *e.g.*,

(i) A system containing fused three- and four-membered rings would be highly strained, and consequently is unlikely to be produced by dehydration with acetic anhydride;  $\beta$ -lactones are not produced under these conditions.

(ii) Many  $\beta$ -lactones are unstable to heat; sydnones are stable and so the  $\beta$ -lactone structure is unlikely.

(iii) If the  $\beta$ -lactone structure is correct, then sydnones should be capable of existing in optically active forms. Kenner and Baker (1946) prepared (+)-*N*-nitroso-*N*-phenylalanine, and when this was converted into a sydnone, the product was optically inactive. If Earl's structure were correct, then the sydnone would be expected to be optically active.

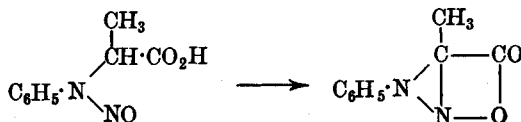

(iv) The aryl nucleus in sydnones is very resistant to substitution by electrophilic reagents. Since the above structure is similar to that of an arylhydrazine, this resistance is unexpected.

Baker *et al.* (1946) therefore proposed a five-membered ring which cannot be represented by any one purely covalent structure; they put forward a number of charged structures, the sydnone being a resonance hybrid, *e.g.*, three charged resonating structures are:

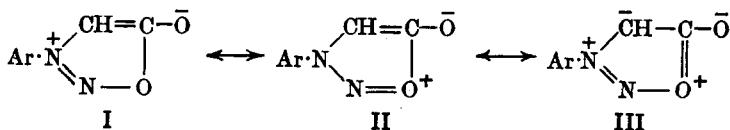

Now Simpson (1945) had proposed structure IV for 3-methyl-5:6-dimethoxyanthranil; Baker *et al.* (1949) adopted this  $\pm$  sign and suggested that sydnones be represented by structure V. Baker also proposed the

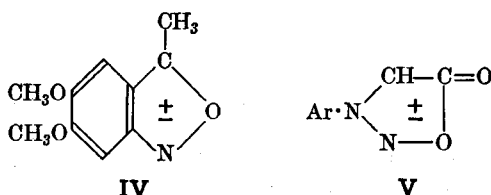

term **meso-ionic** to describe the sydnone structure. Baker *et al.* (1955) have, however, revised the definition of the term meso-ionic, and have proposed formula *Va* instead of V. This is based on the fact that sydnones are aromatic in character, and the circle and plus sign represent the sextet

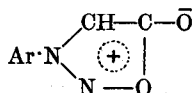
*Va*

of  $\pi$ -electrons in association with a positive charge (the "aromatic sextet" is the essential feature of aromatic compounds).

Dipole moment measurements of various sydnones have shown that the positive end of the dipole is situated on the nitrogen atom attached to the aryl group (Sutton *et al.*, 1947, 1949; Le Fèvre *et al.*, 1947). This is in keeping with Baker's structure.

The meso-ionic structure would necessitate a planar, or almost planar molecule; such a molecule would not be optically active (*cf.* iii above). Earl (1953) has suggested that, from the available evidence, sydnones can be represented as a resonance hybrid, the two main contributing structures being VI and VII.

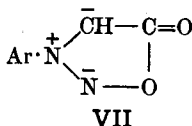
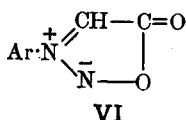

Sutton *et al.* (1949), however, have shown that VI probably contributes to the resonance hybrid, but to a lesser extent than I, II and III.

### TETRAZOLE GROUP

§9. **Tetrazole.** Tetrazole is a five-membered ring which contains one carbon and four nitrogen atoms. There are two tautomeric forms of tetrazole, and replacement of the imino hydrogen by, *e.g.*, an alkyl group gives rise to *two N*-alkyltetrazoles (*cf.* triazoles, §6).

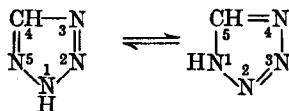

Tetrazole may be prepared by heating hydrogen cyanide with hydrazoic acid in benzene solution at 100°.

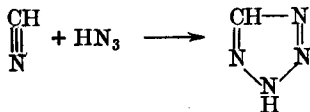

Derivatives of tetrazole may be prepared by the condensation of phenyl azide with phenylhydrazones of aldehydes in the presence of ethanolic sodium ethoxide, *e.g.*, benzaldehyde phenylhydrazone and phenyl azide form 1:4-diphenyltetrazole.

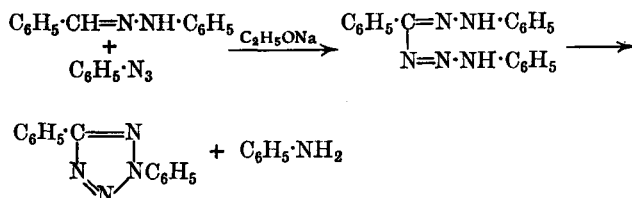

Tetrazole is a colourless solid, m.p. 156°; it has no basic properties, but the imino hydrogen is acidic, *e.g.*, tetrazole forms a silver salt  $[\text{CHN}_4]^- \text{Ag}^+$ .

### AZINES

The suffix *azine* is used for six-membered rings which contain two or more hetero-atoms, at least one of which is nitrogen.

### DIAZINE GROUP

§10. **Introduction.** The diazines are six-membered rings containing two nitrogen atoms. Three isomeric diazines are theoretically possible, and all three are known.

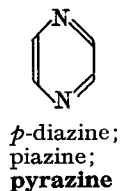
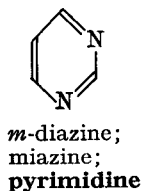
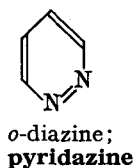

The above formulæ are now usually written with a nitrogen atom at the top, *i.e.*, the formulæ of pyridazine and pyrimidine are inverted.

§11. **Pyridazines.** These may be prepared by the action of hydrazine on 1 : 4-diketones, the intermediate dihydro compound being readily oxidised by atmospheric oxygen.

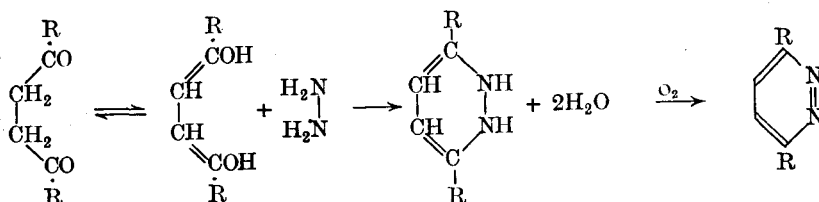

Pyridazine itself may be prepared from maleic dialdehyde and hydrazine hydrate.

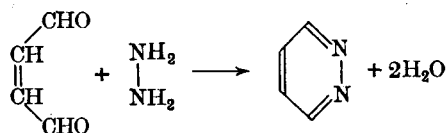

Pyridazine is a colourless liquid, b.p. 208°.

## PYRIMIDINES

§12. **Ureides.** Ureides are acylureas, and may be prepared by the action of an acid anhydride or acid chloride on urea, *e.g.*,

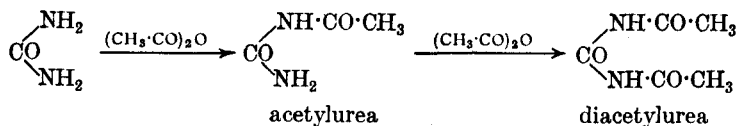

The simple ureides resemble the amides in properties.

**Allophanic acid**,  $\text{NH}_2\cdot\text{CO}\cdot\text{NH}\cdot\text{CO}_2\text{H}$ , is not known in the free state, but many of its esters have been prepared:

(i) By the action of chloroformates on urea.

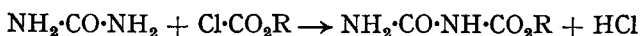

(ii) By the reaction between urethans and cyanic acid.

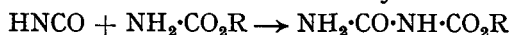

The alkyl allophanates are well-defined crystalline compounds, and so are frequently used to identify alcohols. They are prepared by passing cyanic acid vapour into the dry alcohol; urethans are intermediate products.



According to Close *et al.* (1953), allophanate formation occurs *via* a concerted attack of two molecules of cyanic acid to form a chelate intermediate.

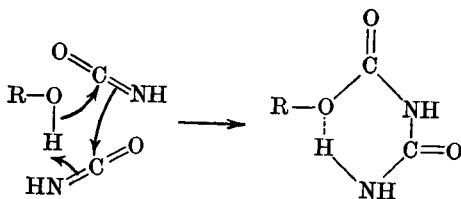

§13. **Cyclic ureides.** Many cyclic ureides are known; some occur naturally and others are synthetic (a number of cyclic ureides—alloxan, allantoin, parabanic acid and hydantoin—are discussed in §2. XVI, in connection with the purines, which are cyclic diureides).

The cyclic ureides containing a *six-membered ring* behave, in a number of ways, as pyrimidine derivatives.

§13a. **Barbituric acid.** A very important pyrimidine derivative is barbituric acid (malonylurea). It was originally prepared by condensing urea with malonic acid in the presence of phosphoryl chloride (Grimaux, 1879).

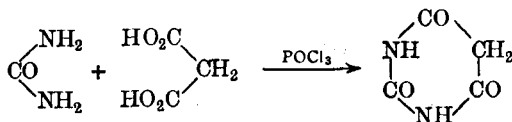

A much better synthesis is to reflux ethyl malonate with urea in ethanolic solution in the presence of sodium ethoxide.

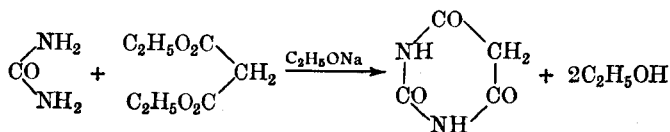



Barbituric acid is a solid, m.p. 253°, and is not very soluble in water. It is strongly acidic due to enolisation (lactam-lactim tautomerism); some possible lactim forms are II-IV. Structure IV represents barbituric acid

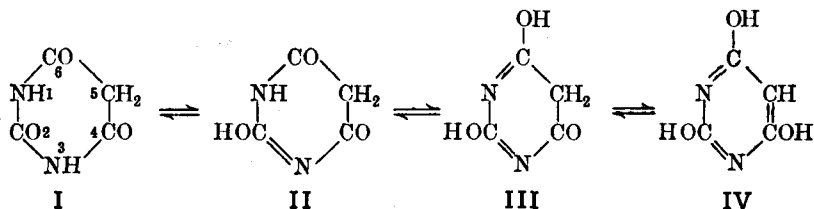

as 2 : 4 : 6-trihydroxypyrimidine, and this structure has been proposed because of the acidic nature of barbituric acid. On the other hand, barbituric acid contains an active methylene group, since it readily forms an oximino derivative with nitrous acid. Thus barbituric acid behaves as if it had structure I, II or III. Furthermore, it is very difficult to acylate hydroxypyrimidines containing hydroxyl groups in the 2-, 4- or 6-positions, thus indicating that structure I is more probable than II or III. This is supported by the fact that methylation of hydroxypyrimidines with, *e.g.*, methyl iodide in the presence of sodium hydroxide, results in the formation of *N*-methyl derivatives; this indicates the probable presence of imino groups. On the other hand, it is possible to replace three hydroxyl groups by three chlorine atoms by means of phosphoryl chloride; this suggests barbituric acid behaves as IV. Barbituric acid also forms *O*-alkyl derivatives, thereby indicating structures II, III and IV.

Barbituric acid can be nitrated and brominated in the 5-position, and also forms metallic derivatives (at position 5). By means of the sodio derivative, one or two alkyl groups may be introduced at position 5 (this reaction is characteristic of the  $-\text{CH}_2\cdot\text{CO}-$  group). Barbituric acid and 5 : 5-dimethylbarbituric acid have no hypnotic action. On the other hand, 5 : 5-diethylbarbituric acid (*Barbitone*, *Veronal*) has a strong hypnotic action; it is best prepared as follows:

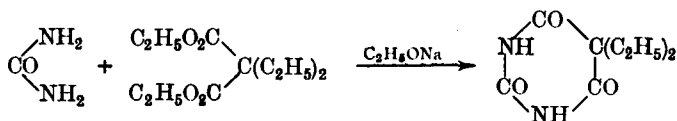

5-*cyclo*Hexyl-3 : 5-dimethylbarbituric acid (*Evipan*) is a better hypnotic than *Barbitone* and is not so toxic. 5-Ethyl-5-phenylbarbituric acid (*Luminal*) is also used in medicine.

**§13b. Derivatives of barbituric acid.** **Violuric acid** (5-oximino-barbituric acid) is formed when barbituric acid is treated with nitrous acid; it is the oxime of alloxan (see §2. XVI). Violuric acid gives a violet colour

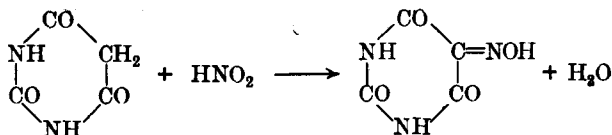

in water, and forms deeply coloured salts with various metals, *e.g.*, the potassium salt is blue and the magnesium and barium salts are purple.

**Dilituric acid** (5-nitrobarbituric acid) may be prepared by nitrating barbituric acid with fuming nitric acid, or by the oxidation of violuric acid with nitric acid.

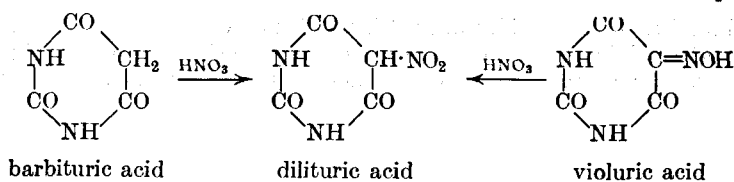

**Uramil** (5-aminobarbituric acid) is formed by the reduction of either dilituric acid or violuric acid.

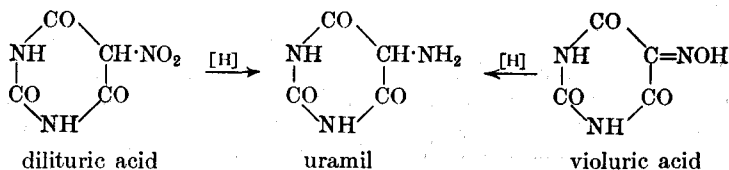

Uramil may also be prepared by the action of ammonium hydrogen sulphite on alloxan, and then boiling the product, **thionuric acid**, with water.

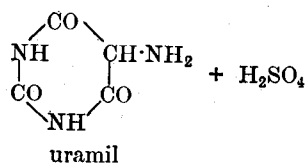
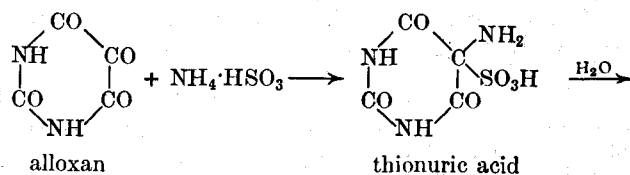

**Dialuric acid** (5-hydroxybarbituric acid) is produced by the action of nitrous acid on uramil; it is also formed when alloxan is reduced with hydrogen sulphide or with zinc and hydrochloric acid.

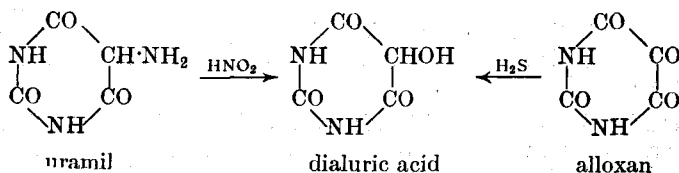

§14. **Pyrimidine**, m.p. 22.5°, b.p. 124°/758 mm., was first prepared from barbituric acid as follows (Gabriel, 1900).

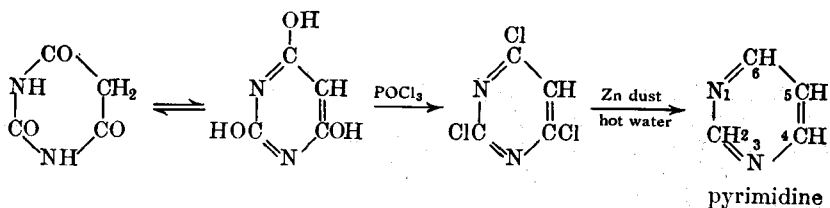

Pyrimidine may also be prepared by the oxidation of alkylpyrimidines, followed by decarboxylation. A recent preparation is the catalytic reductive dechlorination of 2 : 4-dichloropyrimidine; the latter is heated with hydrogen under pressure in the presence of Pd—C and magnesium oxide (Whittaker, 1953).

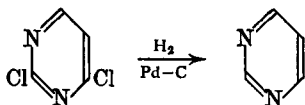

Pyrimidine is neutral in solution, but forms salts with acids. Pyrimidine is probably a resonance hybrid of the following resonating structures:

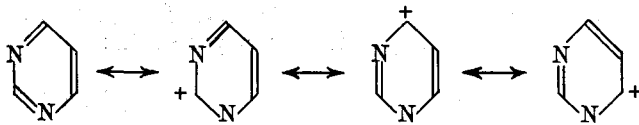

Thus the ring is deactivated, and position 5 has the greatest electron density (*cf.* nitrobenzene and pyridine, Vol. I). It can therefore be expected that attack by electrophilic reagents will be difficult, but attack by nucleophilic reagents (at positions 2, 4 and 6) will be facilitated. Chlorine atoms at 2, 4 or 6 are readily replaced by hydroxyl or amino groups, and an amino group in position 2 or 6 is readily replaced by a hydroxyl group merely on boiling with water (*cf.* vitamin B<sub>1</sub>, §3. XVII).

When a hydroxyl or an amino group is present in the pyrimidine nucleus, the compound no longer behaves entirely as an aromatic derivative. The introduction of hydroxyl or amino groups into positions 2, 4 and 6 progressively diminishes the aromatic properties of the compound (*cf.* barbituric acid, §13a, and uracil, §15).

**Pyrimidine derivatives.** A very important general method for preparing pyrimidines is the condensation between  $\beta$ -carbonyl compounds of the type  $R \cdot CO \cdot CH_2 \cdot CO \cdot R'$ , where  $R$  and  $R' = H, R, OR, CN$ , and compounds having the amidine structure  $R \cdot C(=NH) \cdot NH_2$ , where  $R = R$  (an amidine),  $OH$  (urea),  $SH$  or  $SR$  (thiourea or its *S*-derivative),  $NH_2$  (guanidine); the condensation is carried out in the presence of sodium hydroxide or sodium ethoxide. Thus:

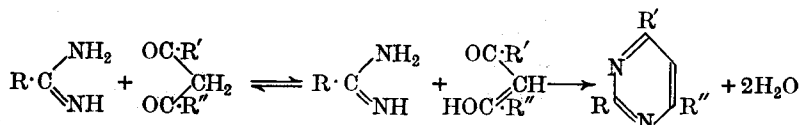

This general reaction may be illustrated by the condensation of acetamide ( $R = CH_3$ ) with ethyl acetoacetate ( $R' = OC_2H_5$ , and  $R'' = CH_3$ ) to form 6-hydroxy-2 : 4-dimethylpyrimidine.

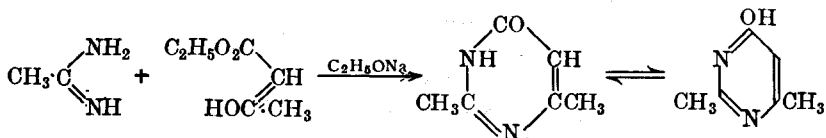

4 : 5-Diaminopyrimidines, which are intermediates in purine synthesis (see §4. XVI), may be prepared by condensing formamidine with phenylazomalononitrile (Todd *et al.*, 1943).

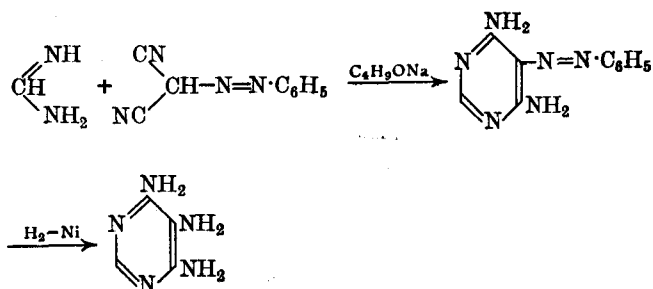

Schaeffer *et al.* (1962) have shown that s-triazine reacts with amidines, amidine salts and imidates having  $\alpha$ -acidic methylene groups to produce 4 : 5-disubstituted pyrimidines (yield: 51-100 per cent.):

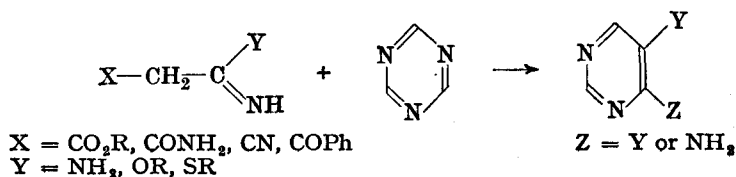

§15. **Uracil** (2 : 6-dihydropyrimidine) is a hydrolytic product of the nucleic acids (§§13, 13b. XVI). It has been synthesised in many ways, *e.g.*,

(i) Fischer and Roeder (1901).

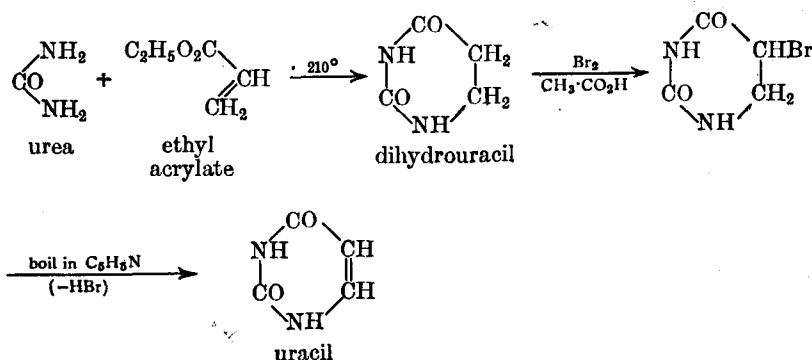

(ii) Wheeler and Liddle (1908).

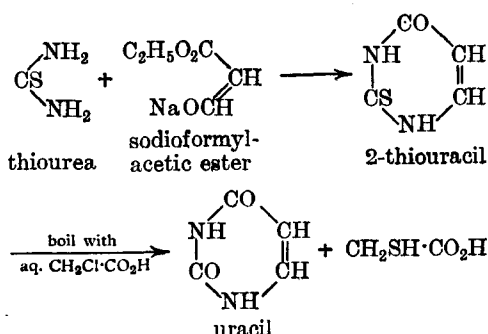

Four tautomeric structures are theoretically possible for uracil.

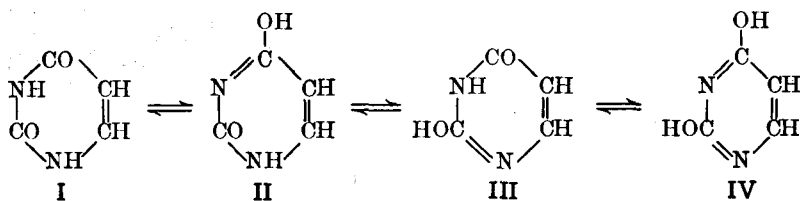

The ultraviolet absorption spectrum of uracil (in ethanol) is different from that of 1:3-dimethyluracil (a derivative of I), from that of 6-methoxy-3-methyluracil (a derivative of II), and from that of 2:6-diethoxyuracil (a derivative of IV). Thus uracil is probably III, and this is supported by the fact that the ultraviolet absorption spectrum of 1-methyluracil (a derivative of III) is similar to that of uracil (Austin, 1934) (but see also §13b. XVI).

§16. **Thymine** (5-methyluracil, 2:6-dihydroxy-5-methylpyrimidine) is a hydrolytic product of the nucleic acids. It has been synthesised by methods similar to those used for uracil.

(i) Fischer and Roeder (1901); in this case ethyl methacrylate is used instead of ethyl acrylate.

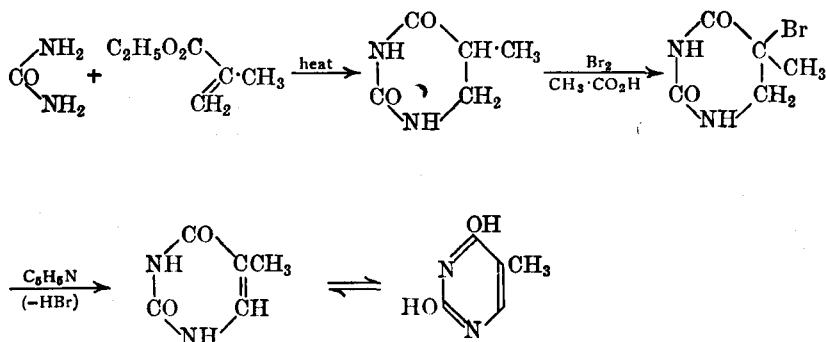

(ii) Wheeler and Liddle (1908); in this case sodioformylpropionic ester is used instead of sodioformylacetic ester.

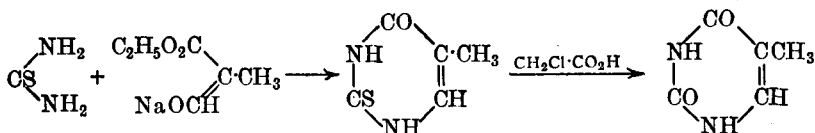

§17. **Cytosine** (6-aminouracil, 6-amino-2-hydroxypyrimidine) is a hydrolytic product of the nucleic acids. It has been synthesised by Wheeler and Johnson (1903) starting from *S*-ethylisothiurea and sodioformylacetic ester (see also §13b. XVI).

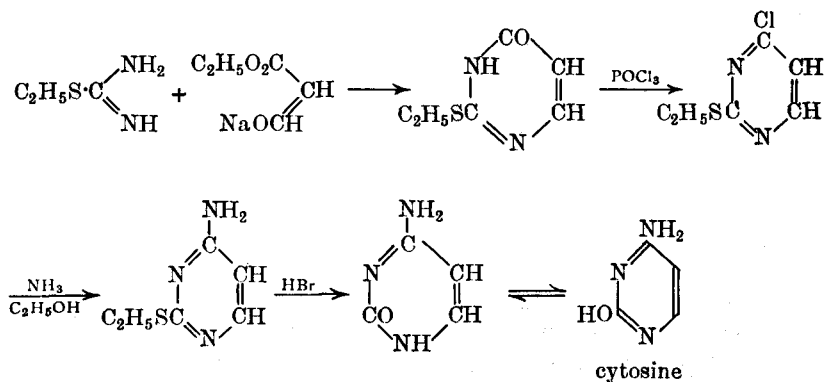

### Pyrazines

§18. Pyrazines may be prepared by the self-condensation of an  $\alpha$ -amino-ketone in the presence of an oxidising agent such as mercuric chloride; the intermediate dihydro compound is readily oxidised to the pyrazine (Gabriel *et al.*, 1893).

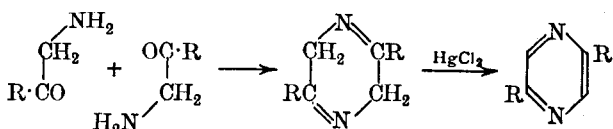

Actually, only the salts of  $\alpha$ -aminoketo compounds are known; addition of alkali liberates the free base which immediately forms a pyrazine in the presence of mercuric chloride.

Pyrazine itself may be prepared from aminoacetaldehyde (R = H in the above equations). The best method, however, for preparing pyrazine is as follows (Wolff *et al.*, 1908).

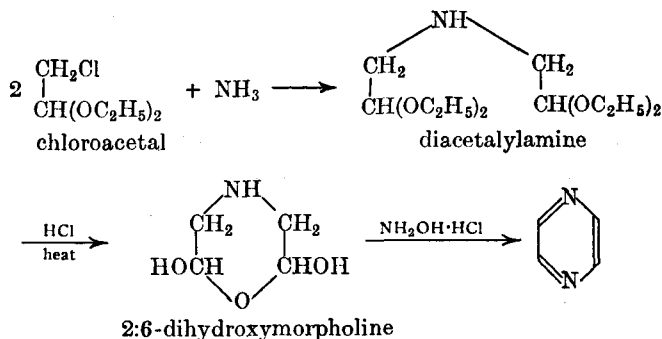

A convenient general method for preparing pyrazines is to heat an  $\alpha$ -amino-acid with acetic anhydride in the presence of pyridine, hydrolyse the product (an acetamidoketone) with acid and then warm with sodium hydroxide in the presence of mercuric chloride (Dakin *et al.*, 1928). This method is thus similar to the first general method given above, but offers a convenient method of preparing  $\alpha$ -aminocarbonyl compounds.

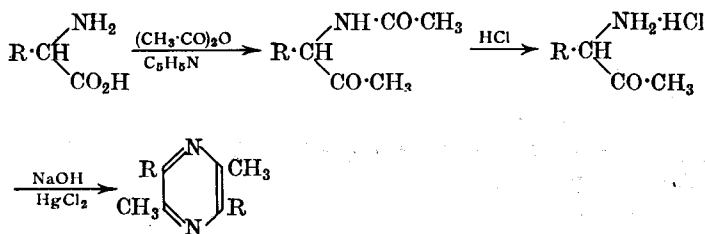

Pyrazine is a solid, m.p. 55°; pyrazines (and pyrazine) are readily reduced by sodium and ethanol to hexahydropyrazines or **piperazines**. Piperazine, m.p. 104°, is a strong diacid base. 2:5-Diketopiperazines are produced from  $\alpha$ -amino-acids (see §4 C. XIII).

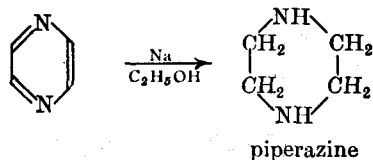

### BENZODIAZINES

§19. The following benzodiazines are theoretically possible, and all are known; the first two are derived from pyridazine, the third from pyrimidine and the fourth from pyrazine.

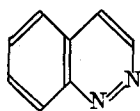

cinnoline

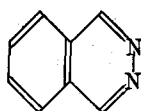

phthalazine

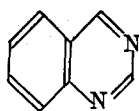

quinazoline

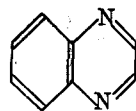

quinoxaline

**Cinnolines** may be prepared by the cyclisation of diazotised *o*-aminoacetophenones (Schofield *et al.*, 1948), *e.g.*,

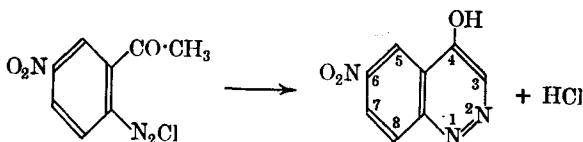

**Phthalazines** are formed by heating the benzoyl derivative of benzaldehyde hydrazones, *e.g.*,

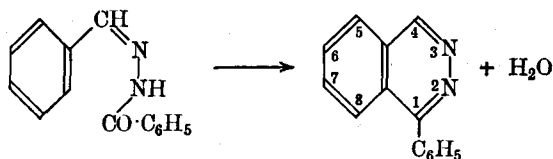

**Quinazolines** may be prepared by the action of ammonia on acylated *o*-aminobenzaldehydes or *o*-aminoacetophenones (Isensee *et al.*, 1948), *e.g.*,

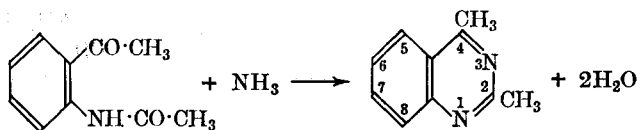

**Quinoxalines** are formed by the condensation of *o*-phenylenediamines with  $\alpha$ -dioxo compounds, *e.g.*,

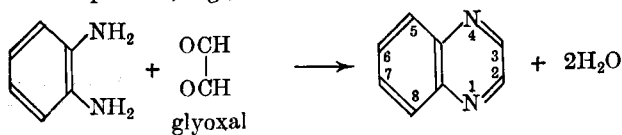

The formation of quinoxalines is used to identify aromatic *o*-diamines and 1 : 2-diketones (see, *e.g.*, §9. XVII).



Of the *dibenzodiazines*, only the **phenazines** (*dibenzopyrazines*) are important. Phenazine, m.p. 171°, may be prepared by condensing *o*-phenylenediamine with catechol in the presence of air.

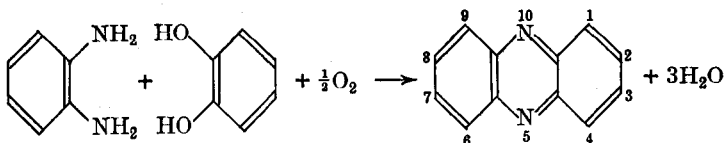

Phenazine forms unstable salts (coloured red or yellow) in excess of strong acids. Many dyes are derived from phenazine, *e.g.*, the safranines (see Vol. I).

#### DIAZINES CONTAINING ONE NITROGEN ATOM AND AN OXYGEN OR SULPHUR ATOM

§20. **Oxazines.** *Morpholine* is tetrahydro-1 : 4-oxazine, and it may be prepared as follows:

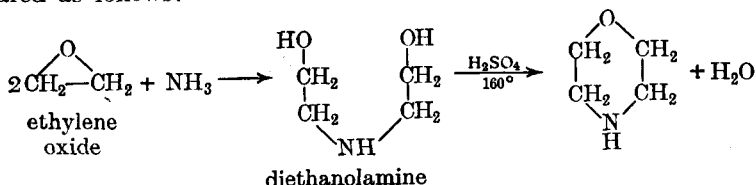

Morpholine is a liquid, b.p. 128°, and is strongly basic. It is miscible with water in all proportions, and is widely used as a solvent.

§21. **Phenoxazines.** These are formed by condensing *o*-aminophenols with catechols at 260°, *e.g.*,

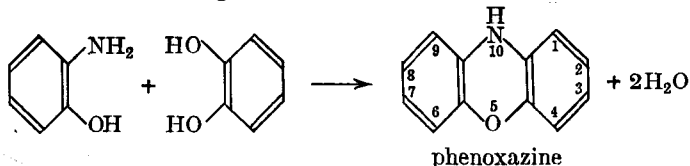



Phenoxazines are also produced by the action of alkali on 2-hydroxy-2'-nitrodiphenylamines, *e.g.*,

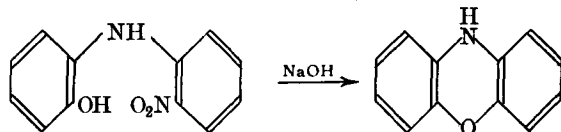

Phenoxazine is a solid, m.p. 156°; it is the parent substance of a number of dyes, *e.g.*, Meldola's Blue (see Vol. I).

§22. **Thiazines.** *Phenothiazines* may be prepared by heating *o*-aminothiophenols with catechols, *e.g.*,

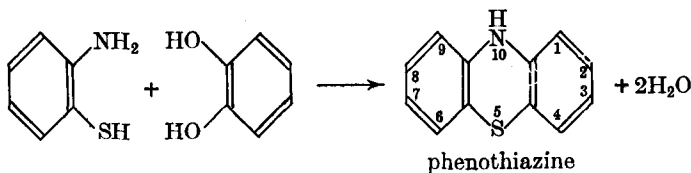

Phenothiazine may also be prepared by fusing diphenylamine with sulphur.

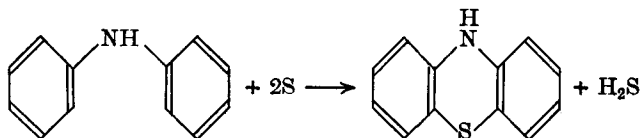

Phenothiazine, m.p. 185°, is used as an insecticide; it is the parent substance of a number of dyes, *e.g.*, Methylene Blue (see Vol. I).

### TRIAZINES AND TETRAZINES

§23. **Triazines.** Three triazines are theoretically possible; the parent compounds are unknown, but derivatives of each have been prepared.

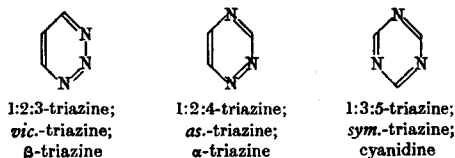

Cyanuric acid, cyamelide and hexamethylenetetramine are derivatives of *sym.*-triazine (see Vol. I).

§24. **Tetrazines.** Only derivatives of two tetrazines are known.

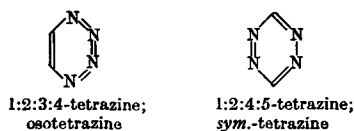

§25. Some important condensed systems containing *two* fused heterocyclic systems are:

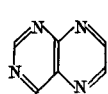

pteridine

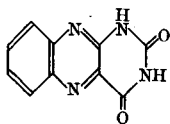

alloxazine

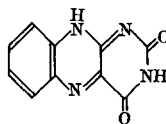

isoalloxazine

These occur in natural products (see Ch. XVII, Vitamins). It appears that *isoalloxazine*, the tautomer of *alloxazine*, does not exist as such; only when the hydrogen atom is substituted is the *isoalloxazine* form retained (see §6. XVII).

#### READING REFERENCES

- Gilman (Ed.), *Advanced Organic Chemistry*, Wiley. Vol. IV (1953). Ch. 8. Heterocyclic Chemistry.
- Morton, *The Chemistry of Heterocyclic Compounds*, McGraw-Hill (1946).
- Acheson, *An Introduction to the Chemistry of Heterocyclic Compounds*, Interscience (1960).
- Badger, *The Chemistry of Heterocyclic Compounds*, Academic Press (1961).
- Rodd (Ed.), *Chemistry of the Carbon Compounds*, Elsevier. Vol. IVA, B and C (1958-1960). Heterocyclic Compounds.
- Elderfield (Ed.), *Heterocyclic Compounds*, Wiley (1951- ).
- Patterson and Capell, *The Ring Index*, Reinhold (1940).
- Handbook for Chemical Society Authors*, Chem. Soc. (1960). Pp. 90-106. Heterocyclic Systems.
- Finar and Simmonds, The Reaction between Aroylacetoncs and Arylhydrazines, *J.C.S.*, **1958**, 200.
- Wright, The Chemistry of the Benzimidazoles, *Chem. Reviews*, 1951, **48**, 397.
- Wiley, The Chemistry of the Oxazoles, *Chem. Reviews*, 1945, **37**, 401.
- Organic Reactions*, Wiley. Vol. VI (1951). Ch. 8. The Preparation of Thiazoles.
- Benson and Savell, The Chemistry of the Vicinal Triazoles, *Chem. Reviews*, 1950, **46**, 1.
- Potts, The Chemistry of 1,2,4-Triazoles, *Chem. Reviews*, 1961, **61**, 87.
- Baker and Ollis, Meso-ionic Compounds, *Quart. Reviews (Chem. Soc.)*, 1957, **11**, 15.
- Benson, The Chemistry of the Tetrazoles, *Chem. Reviews*, 1947, **41**, 1.
- Nineham, The Chemistry of Formazans and Tetrazolium Salts, *Chem. Reviews*, 1955, **55**, 355.
- Franklin, Heterocyclic Nitrogen Compounds; Part I. Pentacyclic Compounds, *Chem. Reviews*, 1935, **16**, 305.
- Johnson and Hahn, Pyrimidines; Their Amino and Amino-oxy Derivatives, *Chem. Reviews*, 1933, **13**, 193.
- Shriner and Neumann, The Chemistry of the Amidines, *Chem. Reviews*, 1944, **35**, p. 395; The formation of substituted pyrimidines.
- Lythgoe, Some Aspects of Pyrimidine and Purine Chemistry, *Quart. Reviews (Chem. Soc.)*, 1949, **3**, 181.
- Krems and Spoerri, The Pyrazines, *Chem. Reviews*, 1947, **40**, 279.
- Leonard, The Chemistry of the Cinnolines, *Chem. Reviews*, 1945, **37**, 269.
- Vaughan, The Chemistry of the Phthalazines, *Chem. Reviews*, 1948, **43**, 447.
- Gates, The Chemistry of the Pteridines, *Chem. Reviews*, 1947, **41**, 63.
- King, Three- and Four-Membered Heterocyclic Rings, *J.C.S.*, **1949**, 1318.

CHAPTER XIII  
AMINO-ACIDS AND PROTEINS

**§1. Classification of the amino-acids.** When hydrolysed by acids, alkalis or enzymes, proteins (§6) yield a mixture of amino-acids. Acid hydrolysis destroys certain amino-acids, particularly tryptophan. On the other hand, alkaline hydrolysis causes complete racemisation and also the destruction of a number of amino-acids, *e.g.*, serine, threonine, cysteiné, etc. Enzymic hydrolysis has also difficulties, particularly the long time that is usually needed and the fact that the hydrolysis is often not complete. Thus acid hydrolysis is the most satisfactory, but enzymic hydrolysis is very useful for the isolation of tryptophan. Gurnani *et al.* (1955) have introduced an improved method for the hydrolysis of proteins. The tissue is first dissolved in 85 per cent. formic acid and then 2N hydrochloric acid is added; all the amino-acids, except tryptophan, are liberated within two hours. The number of amino-acids so far obtained from proteins appears to be about twenty-five, all of which except two are  $\alpha$ -amino-acids; the two exceptions are proline and hydroxyproline, which are imino-acids (see list of amino-acids below). Ten of the amino-acids are essential acids, *i.e.*, a deficiency in any one prevents growth in young animals, and may even cause death. The amino-acids are classified in several ways; the table on pages 452 and 453 shows a convenient classification; the letters *g*, *l* and *e* which follow the name of the acids indicate that the acid is respectively of general occurrence, lesser occurrence and essential (to man).

The  $\alpha$ -amino-acids listed in the table have been isolated from proteins. Plants have continued to provide new amino-acids of diverse structure; between 1950 and 1960 about fifty amino- or imino-acids have been identified as components of higher plants. About 20 more have been recognised as constituents of micro-organisms or have been obtained as fragments of the antibiotics excreted by the micro-organisms. These discoveries are the result of the application of paper and ion-exchange chromatography to the examination of plant extracts.

**§2. General methods of preparation of the amino-acids.** There are many general methods for preparing  $\alpha$ -amino-acids, but usually each method applies to a small number of particular acids; many acids are also synthesised by methods special to an individual. It should also be noted that very often a synthesis is a more convenient way of preparing an amino-acid than preparing it from natural sources.

(i) **Amination of  $\alpha$ -halogenated acids** (Perkin *et al.*, 1858).

(a) An  $\alpha$ -chloro- or bromo-acid is treated with concentrated ammonia, *e.g.*,

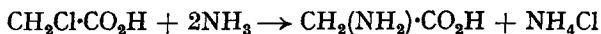

This method is convenient for the preparation of glycine, alanine, serine, threonine, valine, leucine and norleucine.

(b) The yields obtained by the above method are variable because of side-reactions. Better yields are obtained by using *Gabriel's phthalimide synthesis* (1889) with  $\alpha$ -halogeno-acids (see also Vol. I), *e.g.*,

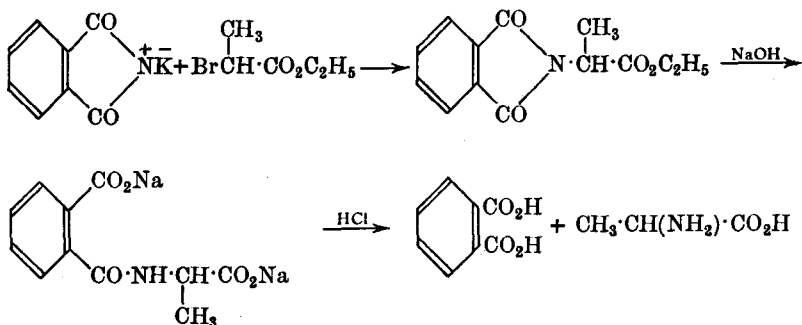

(ii) **Strecker synthesis** (1850). A cyanohydrin is treated with concentrated ammonia, and the resulting amino-nitrile is then hydrolysed with acid. In practice the amino-nitrile is usually prepared from the oxo compound in one step by treating the latter with an equimolecular mixture of ammonium chloride and potassium cyanide (this mixture is equivalent to ammonium cyanide), *e.g.*,

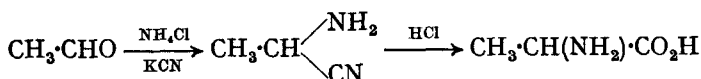

This method is useful for preparing the following amino-acids: glycine, alanine, serine, valine, methionine, glutamic acid, leucine, norleucine and phenylalanine.

(iii) **Malonic ester synthesis**. This method is really an extension of (i) *a*; it offers a means of preparing  $\alpha$ -halogeno-acids, *e.g.*,

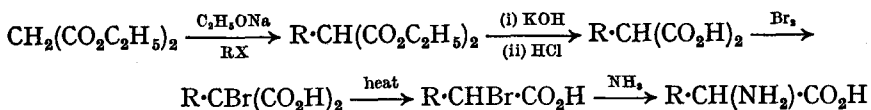

This method offers a means of preparing, from readily accessible materials, the following acids: phenylalanine, proline, leucine, *isoleucine*, norleucine and methionine.

The malonic ester synthesis may also be combined with the Gabriel phthalimide synthesis to prepare phenylalanine, tyrosine, proline, cystine, serine, aspartic acid, methionine and lysine, *e.g.*,

### Cystine.

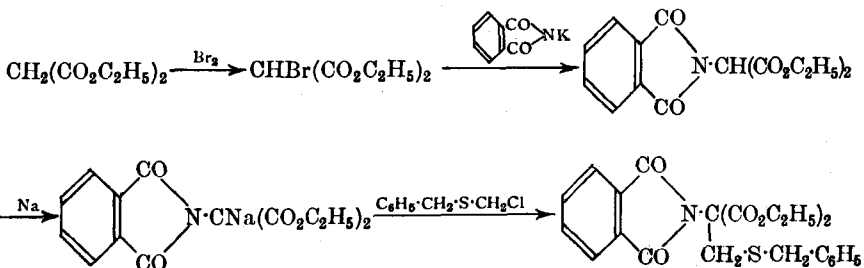
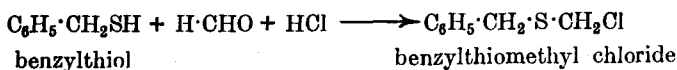

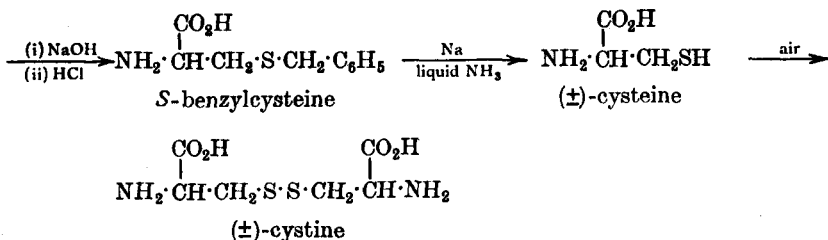
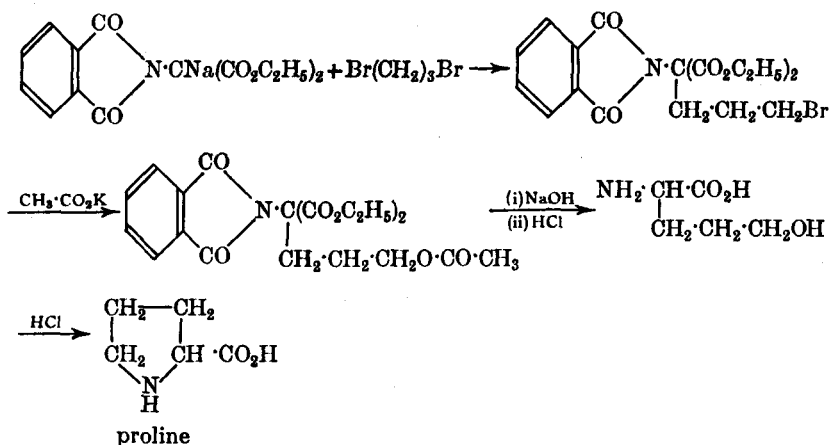
**Proline.**

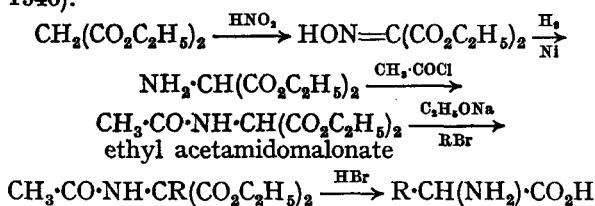

Acylamido derivatives of malonic ester may also be used to synthesise amino-acids; the usual derivative employed is ethyl acetamidomalonnate (Albertson, 1946).

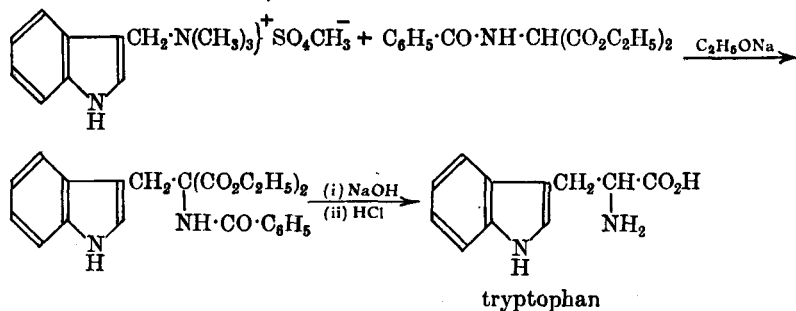

The following acids may be prepared by this method: serine, leucine, valine, methionine, lysine, glutamic acid and ornithine.

A special application of this method is the preparation of tryptophan from benzamidomalonic ester and gramine methosulphate (Albertson *et al.*, 1945; Tishler *et al.*, 1945).

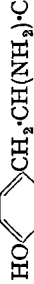
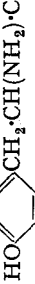

Name	Systematic Name	Formula
<b>Neutral Amino-acids (one amino-group and one carboxyl group)</b>		
1. Glycine ( <i>g</i> )	Aminoacetic acid	$\text{CH}_2(\text{NH}_2) \cdot \text{CO}_2\text{H}$
2. Alanine ( <i>g</i> )	$\alpha$ -Aminopropionic acid	$\text{CH}_3 \cdot \text{CH}(\text{NH}_2) \cdot \text{CO}_2\text{H}$
3. Valine ( <i>g, e</i> )	$\alpha$ -Aminoisovaleric acid	$(\text{CH}_3)_2\text{CH} \cdot \text{CH}(\text{NH}_2) \cdot \text{CO}_2\text{H}$
4. Leucine ( <i>g, e</i> )	$\alpha$ -Aminoisocaproic acid	$(\text{CH}_3)_2\text{CH} \cdot \text{CH}_2 \cdot \text{CH}(\text{NH}_2) \cdot \text{CO}_2\text{H}$
5. <i>iso</i> Leucine ( <i>g, e</i> )	$\alpha$ -Amino- $\beta$ -methyl- <i>n</i> -valeric acid	$\text{CH}_3 \cdot \text{CH}_2 \cdot \text{CH}(\text{CH}_3) \cdot \text{CH}(\text{NH}_2) \cdot \text{CO}_2\text{H}$
6. Norleucine ( <i>l</i> )	$\alpha$ -Amino- <i>n</i> -caproic acid	$\text{CH}_3 \cdot (\text{CH}_2)_3 \cdot \text{CH}(\text{NH}_2) \cdot \text{CO}_2\text{H}$
7. Phenylalanine ( <i>g, e</i> )	$\alpha$ -Amino- $\beta$ -phenylpropionic acid	$\text{C}_6\text{H}_5 \cdot \text{CH}_2 \cdot \text{CH}(\text{NH}_2) \cdot \text{CO}_2\text{H}$
8. Tyrosine ( <i>g</i> )	$\alpha$ -Amino- $\beta$ -( <i>p</i> -hydroxyphenyl)propionic acid	
9. Serine ( <i>g</i> )	$\alpha$ -Amino- $\beta$ -hydroxypropionic acid	$\text{HOCH}_2 \cdot \text{CH}(\text{NH}_2) \cdot \text{CO}_2\text{H}$
10. Cysteine <sup>2</sup> ( <i>g</i> )	$\alpha$ -Amino- $\beta$ -mercaptopropionic acid	$\text{HSCH}_2 \cdot \text{CH}(\text{NH}_2) \cdot \text{CO}_2\text{H}$
11. Cystine ( <i>g</i> )	Bis-( $\alpha$ -aminopropionic acid)- $\beta$ -disulphide	$[\text{—SCH}_2 \cdot \text{CH}(\text{NH}_2) \cdot \text{CO}_2\text{H}]_2$
12. Threonine ( <i>g, e</i> )	$\alpha$ -Amino- $\beta$ -hydroxy- <i>n</i> -butyric acid	$\text{CH}_3 \cdot \text{CHOH} \cdot \text{CH}(\text{NH}_2) \cdot \text{CO}_2\text{H}$
13. Methionine ( <i>g, e</i> )	$\alpha$ -Amino- $\gamma$ -methylthio- <i>n</i> -butyric acid	$\text{CH}_3 \cdot \text{SCH}_2 \cdot \text{CH}_2 \cdot \text{CH}(\text{NH}_2) \cdot \text{CO}_2\text{H}$
14. Iodogorgic acid ( <i>l</i> )	3 : 5-Di-iodotyrosine	
15. Thyroxine ( <i>l</i> )	$\beta$ -3 : 5-Di-iodo-4-(3' : 5'-di-iodo-4'-hydroxy)phenyl- $\alpha$ -aminopropionic acid	
16. Tryptophan ( <i>g, e</i> )	$\alpha$ -Amino- $\beta$ -indolepropionic acid	

17. Proline (g)	Pyrrrolidine- $\alpha$ -carboxylic acid	$  \begin{array}{c}  \text{CH}_2 \\    \\  \text{CH}_2 - \text{CH} \\    \quad   \\  \text{CH}_2 \quad \text{N} \\    \quad   \\  \text{CH}_2 \quad \text{H} \\    \\  \text{CH} \cdot \text{CO}_2\text{H}  \end{array}  $
18. Hydroxyproline (l)	$\gamma$ -Hydroxypyrrrolidine- $\alpha$ -carboxylic acid	$  \begin{array}{c}  \text{HOCH} - \text{CH}_2 \\    \quad   \\  \text{CH}_2 \quad \text{N} \\    \quad   \\  \text{CH}_2 \quad \text{H} \\    \\  \text{CH} \cdot \text{CO}_2\text{H}  \end{array}  $
<b>Acidic Amino-acids (one amino-group and two carboxyl groups)</b>		
19. Aspartic acid (g)	$\alpha$ -Aminosuccinic acid	$\text{CO}_2\text{H} \cdot \text{CH}_2 \cdot \text{CH}(\text{NH}_2) \cdot \text{CO}_2\text{H}$
20. Asparagine (l)	$\alpha$ -Aminosuccinamic acid	$\text{CONH}_2 \cdot \text{CH}_2 \cdot \text{CH}(\text{NH}_2) \cdot \text{CO}_2\text{H}$
21. Glutamic acid (g)	$\alpha$ -Aminoglutaric acid	$\text{HO}_2\text{C} \cdot \text{CH}_2 \cdot \text{CH}_2 \cdot \text{CH}(\text{NH}_2) \cdot \text{CO}_2\text{H}$
22. $\beta$ -Hydroxyglutamic acid <sup>3</sup>	$\alpha$ -Amino- $\beta$ -hydroxyglutaric acid	$\text{HO}_2\text{C} \cdot \text{CH}_2 \cdot \text{CHOH} \cdot \text{CH}(\text{NH}_2) \cdot \text{CO}_2\text{H}$
23. Glutamine (l)	$\alpha$ -Aminoglutaramic acid	$\text{CONH}_2 \cdot \text{CH}_2 \cdot \text{CH}_2 \cdot \text{CH}(\text{NH}_2) \cdot \text{CO}_2\text{H}$
<b>Basic Amino-acids (two amino-groups and one carboxyl group)</b>		
24. Ornithine <sup>4</sup>	$\alpha$ : $\delta$ -Diamino- <i>n</i> -valeric acid	$\text{NH}_2 \cdot \text{CH}_2 \cdot \text{CH}_2 \cdot \text{CH}_2 \cdot \text{CH}(\text{NH}_2) \cdot \text{CO}_2\text{H}$
25. Arginine (g, e)	$\alpha$ -Amino- $\delta$ -guanidino- <i>n</i> -valeric acid	$  \begin{array}{c}  \text{NH}_2 \\    \\  \text{NH} = \text{C} \cdot \text{NH} \cdot (\text{CH}_2)_3 \cdot \text{CH}(\text{NH}_2) \cdot \text{CO}_2\text{H} \\    \\  \text{NH}_2 \cdot (\text{CH}_2) \cdot \text{CH}(\text{NH}_2) \cdot \text{CO}_2\text{H} \\    \\  \begin{array}{c} \text{HN} \quad \text{N} \\ \diagdown \quad / \end{array}  \end{array}  $
26. Lysine (g, e)	$\alpha$ : $\epsilon$ -Diaminocaproic acid	$\text{NH}_2 \cdot (\text{CH}_2)_4 \cdot \text{CH}(\text{NH}_2) \cdot \text{CO}_2\text{H}$
27. Histidine (g, e)	$\alpha$ -Amino- $\beta$ -imidazolepropionic acid	$  \begin{array}{c}  \text{HN} \quad \text{N} \\  \diagdown \quad / \\  \text{CH}_2 \cdot \text{CH}(\text{NH}_2) \cdot \text{CO}_2\text{H}  \end{array}  $

<sup>1</sup> The occurrence of norleucine in proteins is uncertain.

<sup>2</sup> Cysteine has not yet definitely been shown to be present in proteins, but its presence is inferred from various tests.

<sup>3</sup> The occurrence of  $\beta$ -hydroxyglutamic acid in proteins is uncertain.

<sup>4</sup> Ornithine is probably not present in proteins, but is formed by the hydrolysis of arginine.

A more recent method of preparing ethyl acetamidomalonate is to reduce oximinomalonic ester in a mixture of acetic anhydride, pyridine and sodium acetate with hydrogen in the presence of Raney nickel (Vignau, 1952).

(iii*b*)  $\alpha$ -Amino-acids may be synthesised by means of the **Curtius reaction** (see also Vol. I).

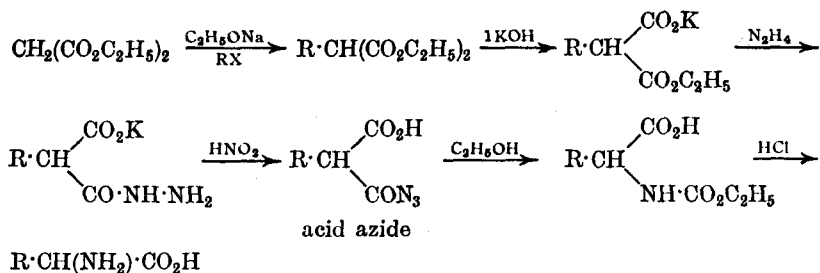

Glycine, alanine, phenylalanine and valine can be prepared by this method. Instead of malonic ester, the starting material can be ethyl cyanoacetate.

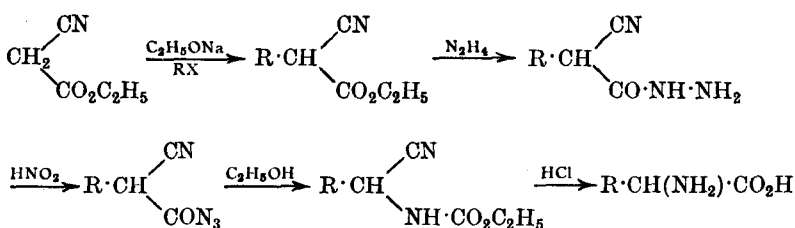

Phenylalanine and tyrosine are conveniently prepared by this method.

Another variation is the use of the Hofmann degradation on ester amides (see also Vol. I).

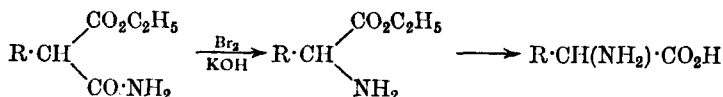

(iii*c*) **The Darapsky synthesis** (1936). In this method an aldehyde is condensed with ethyl cyanoacetate and simultaneously hydrogenated; the product, an alkylcyanoacetic ester, is then treated as above (for the cyanoacetic ester method).

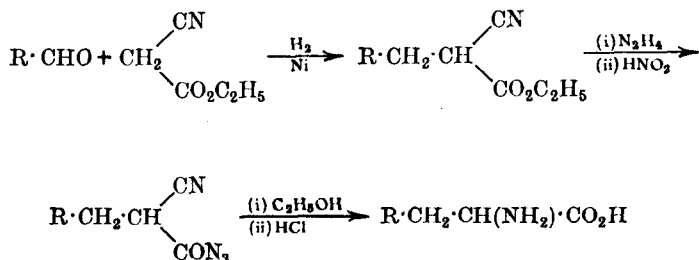

(iv) Amino-acids may be prepared by reducing  $\alpha$ -ketoic acids in the presence of ammonia; the reduction may be performed catalytically, or with sodium and ethanol. The mechanism of the reaction is not certain, but it probably occurs *via* the imino-acid.



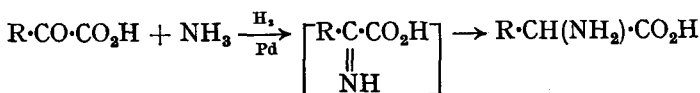

This method works well for alanine and glutamic acid.

Oximes of  $\alpha$ -keto-acids may also be reduced to  $\alpha$ -amino-acids. The advantage of this method is that the oximes may readily be prepared in good yield by the action of sulphuric acid on a mixture of an alkylacetoacetic ester and an alkyl nitrite (Hartung *et al.*, 1942).

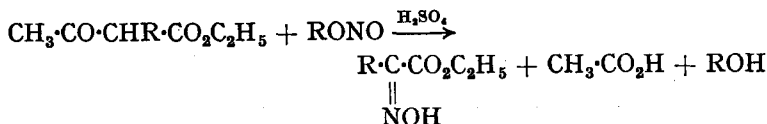

The reduction of phenylhydrazones made by the action of a diazonium salt on an alkylacetoacetic ester also may be used to prepare  $\alpha$ -amino-acids (*cf.* the Japp-Klingermann reaction, Vol. I); *e.g.*,

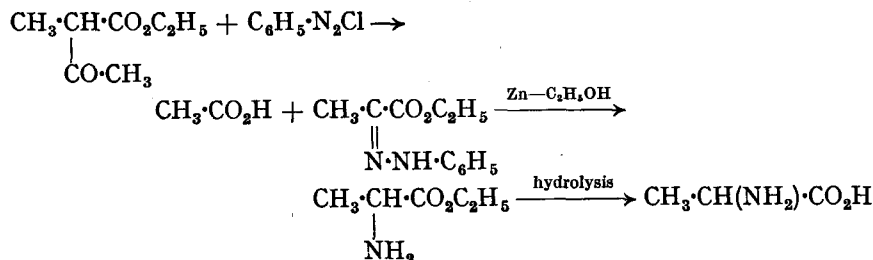

Thus alanine, phenylalanine, leucine, *isoleucine*, valine and hydroxyproline may be prepared in this way.

Alkylacetoacetic esters may also be converted into  $\alpha$ -amino-acids by means of the Schmidt reaction (see also Vol. I).

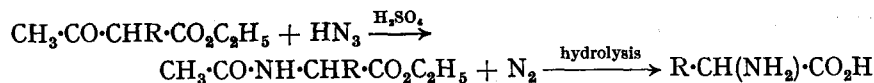

(*va*) **The Azlactone synthesis** (*Erlenmeyer synthesis*, 1893). Azlactones are usually prepared by heating an aromatic aldehyde with hippuric acid (benzoylglycine) in the presence of acetic anhydride and sodium acetate, *e.g.*, benzaldehyde forms benzoyl- $\alpha$ -aminocinnamic azlactone (4-benzylidene-2-phenyloxazol-5-one).

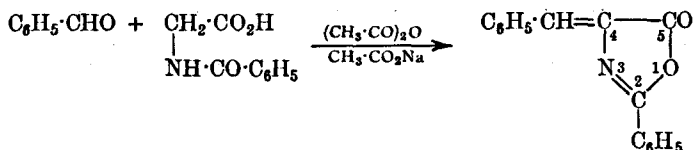

This reaction is usually referred to as the **Erlenmeyer azlactone synthesis**. Aceturic acid (acetylglycine) may also be used instead of hippuric acid. Furthermore, it has been found that aliphatic aldehydes may condense with hippuric acid to form azlactones if lead acetate is used instead of sodium acetate (Finar *et al.*, 1949).

When azlactones are warmed with one per cent. sodium hydroxide solution, the ring is opened, and if the product is reduced with sodium amalgam followed by hydrolysis with acid, an  $\alpha$ -amino-acid is produced, *e.g.*,

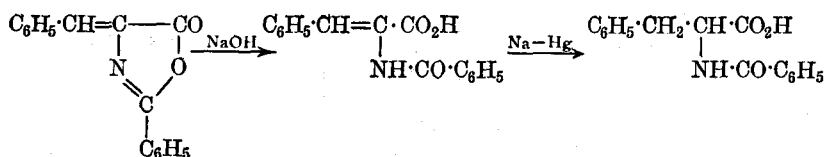

The azlactone synthesis offers a convenient means of preparing phenylalanine, tyrosine, tryptophan and thyroxine.

(vb) Aromatic aldehydes also condense with hydantoin, and reduction of the product with sodium amalgam or ammonium hydrogen sulphide, followed by hydrolysis, gives an  $\alpha$ -amino-acid, *e.g.*, tryptophan may be prepared by first converting indole into indole-3-aldehyde by means of the Reimer-Tiemann reaction (see Vol. I).

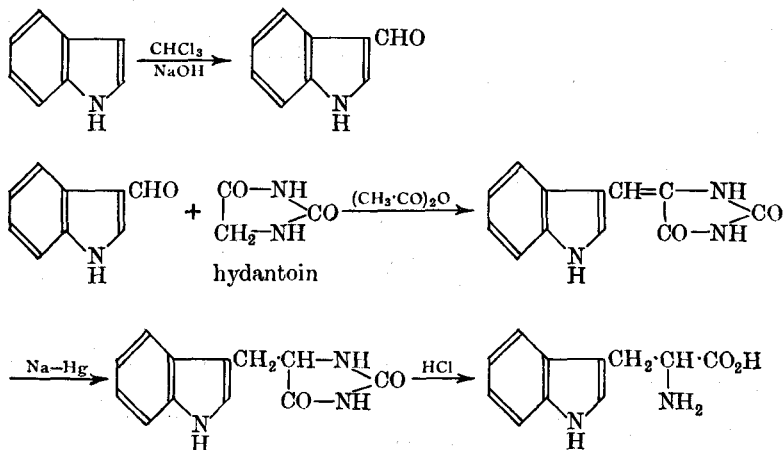

This method has been improved by using acetylthiohydantoin instead of hydantoin.

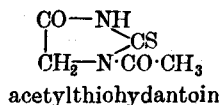

The above method may be used to prepare phenylalanine, tyrosine, tryptophan and methionine.

Another modification of the hydantoin synthesis is the **Bücherer hydantoin synthesis** (1934). In this method an oxo compound is converted into the cyanohydrin and this, on treatment with ammonium carbonate, produces a 5-substituted hydantoin which, on hydrolysis, gives an  $\alpha$ -amino-acid.

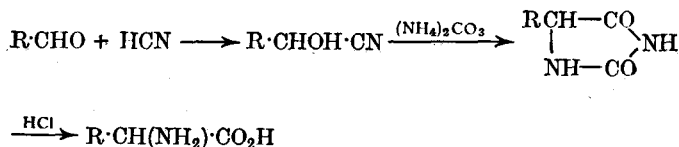

(vc) Aromatic aldehydes may be condensed with diketopiperazine, and the product converted into an amino-acid by heating with hydriodic acid and red phosphorus, *e.g.*,

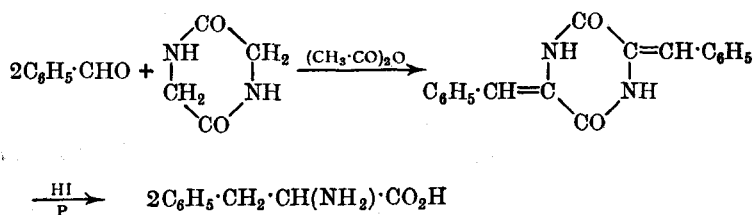

Phenylalanine, tyrosine and methionine may be prepared by this method.

**§3. Isolation of amino-acids from protein hydrolysates.** Many amino-acids can be detected colorimetrically, and these colour reactions have now been developed for quantitative estimation. Also, amino-acids containing a benzene or pyrrolidine nucleus have characteristic absorption spectra; thus the presence of such acids can readily be ascertained.

The actual *quantitative isolation* of amino-acids from their mixtures is a difficult problem. The earliest method was the fractional distillation of the amino-acid esters *in vacuo* (Fischer, 1901). This method is very little used now, and is only satisfactory for the neutral amino-acids (*i.e.*, those containing one amino-group and one carboxyl group).

Neutral amino-acids may be extracted by *n*-butanol saturated with water, and then separated by fractional crystallisation or by the fractional distillation of the esters. After the butanol extraction, the residue may be treated with phosphotungstic acid, whereupon the *basic* amino-acids are precipitated (Dakin *et al.*, 1913).

A number of individual amino-acids can be obtained by means of selective precipitation as salts, *e.g.*, lysine is precipitated by picric acid.

Mixtures of amino-acids may be separated into fractions consisting of the neutral, basic and acidic acids by means of the *electrical transport method*. In this method a P.D. is applied to the mixture at the proper  $\text{pH}$ ; the basic acids (positively charged) migrate to the cathode compartment, the acidic acids (negatively charged) migrate to the anode compartment, and the neutral acids remain in the centre compartment.

The most satisfactory method of analysing amino-acid mixtures is partition chromatography carried out on paper (Martin *et al.*, 1944). The mixture of amino-acids is partitioned between a stationary water phase adsorbed on a strip or sheet of filter paper and a moving phase of some organic solvent (butanol, phenol, etc.). The moving phase either ascends or descends the paper strip (according to the way the experiment is performed). A small amount of the amino-acid solution is applied to one end of the paper, the strip then placed in a suitable glass container containing the organic solvent saturated with water, and when the solvent front has progressed a suitable distance, the distance moved by the solvent is measured, the strip dried, and then sprayed with a dilute solution of ninhydrin in butanol (see also §4C). Coloured spots are produced at the positions of the various amino-acids. The ratio of the distance travelled by the amino-acid to the distance travelled by the solvent is characteristic of each amino-acid, and is known as the  $R_F$  value (this value depends on the experimental conditions).

A very interesting analytical method is the *microbiological assay*. This depends on the fact that micro-organisms can be "trained" to feed on a specific amino-acid in the nutrient medium. The rate of growth of the micro-organism is first measured by breeding in a medium containing the particular amino-acid, and then the rate of growth is measured in the mixture of amino-acids to be analysed. In this way it is possible to determine the amounts of various amino-acids in protein hydrolysates *without* isolation of the acids. Another method of analysis is that of *isotopic dilution*.

Suppose the amount of glycine is to be estimated. A weighed amount of labelled glycine is added to the hydrolysate, and then glycine is isolated by one of the standard methods. The amount of *labelled* glycine in this specimen is now measured, *e.g.*, say it is 1 per cent. Thus for every 1 g. of labelled glycine there are 99 g. of ordinary glycine. Since the weight of the added labelled glycine is known, the total weight of glycine in the mixture can therefore be calculated (see also Vol. I).

**§4. General properties of the amino-acids.** The amino-acids are colourless crystalline compounds which are generally soluble in water but sparingly soluble in organic solvents; most melt with decomposition, but Gross *et al.* (1955) have shown that sublimation is possible with a number of amino-acids. All except glycine contain at least one asymmetric carbon atom, and all (except glycine) occur naturally in their optically active forms. It has been mentioned in §5b. II that natural (–)-serine was chosen as the arbitrary standard for correlating the configurations of amino-acids, the relationship to this acid being indicated by  $D_s$  or  $L_s$ . It has now been shown that  $L_s \equiv L_s$ , *i.e.*, natural (–)-serine belongs to the L-series (with glyceraldehyde as absolute standard). The correlation between the two standards was established as follows. (+)-Alanine has been correlated with L(+)-lactic acid (for the correlation of the latter with L(–)-glyceraldehyde see §5b i. II); and L(+)-alanine has been correlated with L(–)-serine:

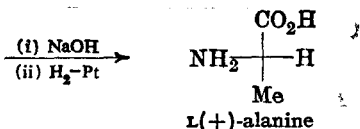
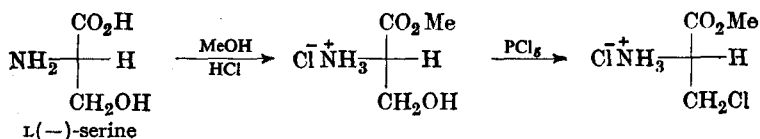
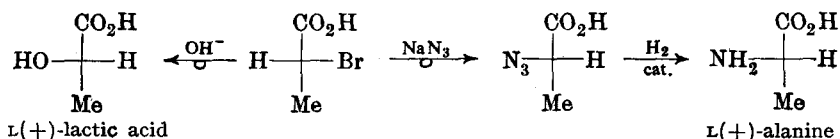

A new method for determining the configuration of an  $\alpha$ -amino-acid is by studying the rotatory dispersion curves of the *N*-alkylthio derivatives. L-Compounds show a positive Cotton effect, whereas the D-compounds show a negative effect (see §12a. I). It has been shown that the  $\alpha$ -carbon atom, *i.e.*, the carbon atom attached to the amino-group, has, in almost all the amino-acids, the same configuration as L(–)-glyceraldehyde. The specific rotation of the amino-acids depends on the pH of the solution, the temperature, the presence of salts and the nature of the solvent (see §12. I). The racemic amino-acids may be resolved by first formylating and then resolving the formyl derivatives *via* the salt with an optically active base, and finally removing the formyl group by hydrolysis (see also C i). Alternatively, racemic amino-acids may be resolved by means of enzymes (see §10 iv. II). A more recent method is the selective destruction of one or other enantiomorph of a racemate by a specific D- or L-oxidase (Parikh *et al.*, 1958); the optical purity of the product is greater than 99.9 per cent. As pointed out above, most natural amino-acids are L; these are obtained by acid or

enzymic hydrolysis of proteins. Alkaline hydrolysis of proteins gives the DL-amino-acids (§1), and so does the synthetic preparation; it is by resolution of the synthetic racemic modification that the D-amino-acids are frequently prepared.

The symbols D and L are used for the configuration of the  $\alpha$ -carbon atom (see above), and the symbols (+) and (-) are used to indicate the direction of the rotation (*cf.* §5. II). When two asymmetric centres are present, then D and L still refer to the  $\alpha$ -carbon atom, and the *naturally occurring acid* is known as the L-amino-acid. The *allo*-form is the name given to that form in which the configuration of the *second asymmetric carbon atom is inverted*, e.g., L(-)-threonine (the naturally occurring form), D(+)-threonine, L-*allo*threonine and D-*allo*threonine.

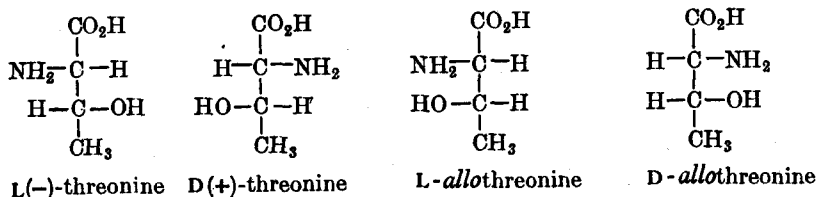

Since they contain amino and carboxyl groups, the amino-acids possess the properties of both a base and an acid, *i.e.*, they are amphoteric.

#### A. Reactions due to the amino-group.

(i) The amino-acids form salts with strong inorganic acids, e.g.,



These salts are usually sparingly soluble in water, and the free acid may be liberated from its salt by means of a strong organic base, e.g., pyridine.

(ii) Amino-acids may be acetylated by means of acetyl chloride or acetic anhydride.

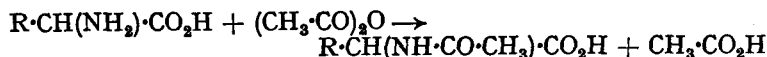

Similarly, benzoyl chloride produces the benzoyl derivative. These acetylated derivatives are acidic, the basic character of the amino-group being effectively eliminated by the presence of the negative group attached to the nitrogen. It should also be noted that the carboxyl group of one molecule can react with the amino-group of another molecule of an amino-acid to form a peptide (see §9). Sanger (1945) has shown that 1-fluoro-2:4-dinitrobenzene combines with amino-acids to form dinitrophenyl derivatives (see §11).

(iii) Nitrous acid liberates nitrogen from amino-acids.

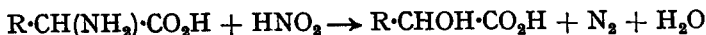

The nitrogen is evolved quantitatively, and this forms the basis of the **van Slyke method** (1911) for analysing mixtures of amino-acids.

(iv) Nitrosyl chloride (or bromide) reacts with amino-acids to form chloro- (or bromo) acids.

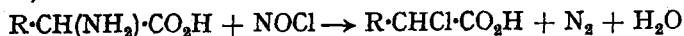

(v) When heated with hydriodic acid at 200°, the amino-group is eliminated with the formation of a fatty acid.

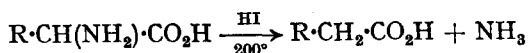

### B. Reactions due to the carboxyl group.

(i) Amino-acids form salts; the salts of the heavy metals are chelate compounds, *e.g.*, the copper salt of glycine (deep blue needles) is formed by heating copper oxide with an aqueous solution of glycine.

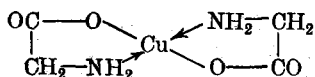

The amino-acids may be liberated from their alkali salts by treatment in ethanolic solution with ethyl oximinocynoacetate (Galat, 1947).

(ii) When heated with an alcohol in the presence of dry hydrogen chloride, amino-acids form ester hydrochlorides, *e.g.*,

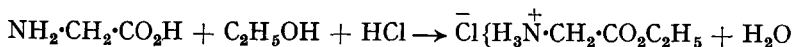

The free ester may be obtained by the action of aqueous sodium carbonate on the ester salt. The esters are fairly readily hydrolysed to the amino-acid by aqueous sodium hydroxide (even at room temperature). These esters may be reduced to the amino-alcohols by means of sodium and ethanol, or hydrogenated in the presence of Raney nickel. Amino-acids may be reduced directly to the amino-alcohol with lithium aluminium hydride, and in this case no racemisation occurs (Vogel *et al.*, 1952).



(iii) When suspended in acetyl chloride and then treated with phosphorus pentachloride, amino-acids form the hydrochloride of the acid chloride.

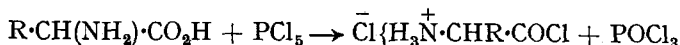

(iv) Dry distillation, or better by heating with barium oxide, decarboxylates amino-acids to amines.

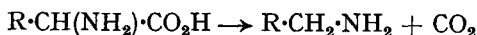

(v) When heated with acetic anhydride in pyridine solution, amino-acids are converted into methyl  $\alpha$ -acetamidoketones (Dakin *et al.*, 1928; see also §18. XII); this reaction is often referred to as the **Dakin-West reaction**.

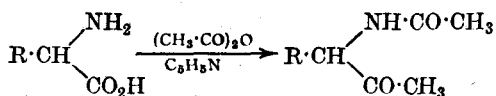

### C. Reactions due to both the amino and carboxyl groups.

(i) When measured in aqueous solution, the dipole moment of glycine (and other amino-acids) is found to have a large value. To account for this large value it has been suggested that glycine exists, in solution, as an *inner salt*:

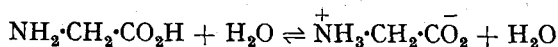

Such a doubly charged ion is also known as a *zwitterion*, *ampholyte* or a *dipolar ion*. This dipolar ion structure also accounts for the absence of acidic and basic properties of an amino-acid (the carboxyl and amino-groups of the *same* molecule neutralise each other to form a salt). The properties of crystalline glycine, *e.g.*, its high melting point and its insolubility in hydrocarbon solvents, also indicate that it exists as the inner salt in the solid state.

Each amino-acid has a definite  $pH$  at which it does not migrate to either electrode when a P.D. is applied. This  $pH$  is known as the **isoelectric point**, and at this point the amino-acid has its lowest solubility.

Owing to their amphoteric character, amino-acids cannot be titrated directly with alkali. When formalin solution is added to glycine, methyleneglycine is formed.



Although some methyleneglycine is probably formed, it appears that the reaction is more complex; the main product appears to be dimethylolglycine.

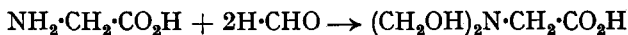

These glycine derivatives are strong acids (the basic character of the amino-group being now suppressed), and can be titrated with alkali. This method is known as the *Sørensen formol titration*.

(ii) When heated,  $\alpha$ -amino-acids form 2 : 5-diketopiperazines; esters give better yields; *e.g.*, diketopiperazine from glycine ester.

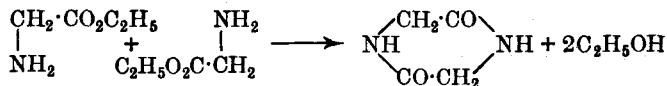

(iii)  $N$ -alkyl or arylamino-acids form  $N$ -nitroso derivatives with nitrous acid, and these may be dehydrated to sydnone by means of acetic anhydride (see §8. XII).

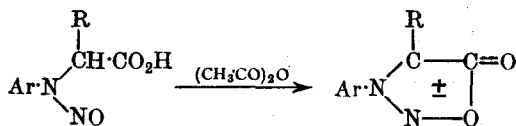

(iv) **Betaines.** These are the trialkyl derivatives of the amino-acids; betaine itself may be prepared by heating glycine with methyl iodide in methanolic solution. The betaines exist as dipolar ions; thus the formation of betaine may be written:

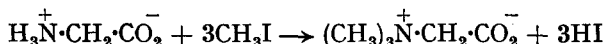

Betaine is more conveniently prepared by warming an aqueous solution of chloroacetic acid with trimethylamine.

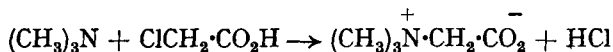

Betaine is a solid, m.p.  $300^\circ$  (with decomposition). It occurs in nature, especially in plant juices. It behaves as a base, *e.g.*, with hydrochloric acid it forms the stable crystalline hydrochloride,  $\text{Cl}\{(\text{CH}_3)_3\text{N}^+\cdot\text{CH}_2\cdot\text{CO}_2\text{H}\}$ .

(v) Amino-acids react with phenyl *isocyanate* to form phenylhydantoic acids, and these, on treatment with hydrochloric acid, readily form hydantoins (see §2. XVI):

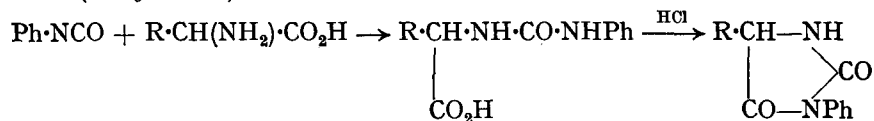

If phenyl *isothiocyanate* is used instead of the *isocyanate*, then thiohydantoins are produced (see §11).

(vi) **Ninhydrin reaction.** Ninhydrin (indane-1:2:3-trione hydrate) reacts with amino-acids as follows:

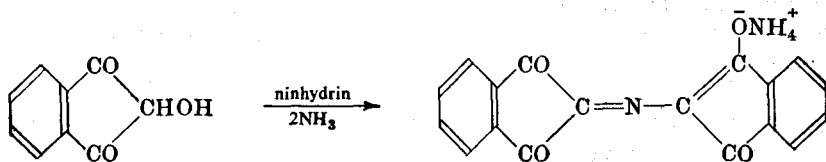
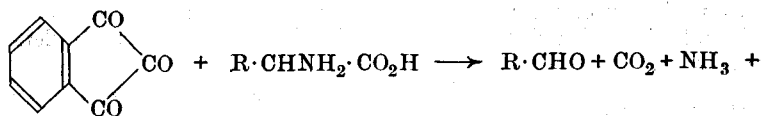

The amino-acid is oxidised to aldehyde and the ninhydrin is reduced to 1:3-diketoinidan-2-ol. The latter then reacts with another molecule of ninhydrin and with ammonia (which is produced in the first reaction) to form a coloured product. This reaction is the basis of a colorimetric method for estimating amino-acids.

§5. **Thyroxine (thyroxin).** Thyroxine is a hormone; it is the active principle of the thyroid gland and was first isolated by Kendall (1919). It was later isolated by Harington (1930) as a white crystalline solid, m.p. 235°, with a laevorotation.

The structure of thyroxine was established by Harington (1926). This author showed that the molecular formula of thyroxine is  $\text{C}_{15}\text{H}_{11}\text{O}_4\text{NI}_4$ . When treated in alkaline solution with hydrogen in the presence of colloidal palladium, the iodine in thyroxine is replaced by hydrogen to form thyronine (thyronin),  $\text{C}_{15}\text{H}_{15}\text{O}_4\text{N}$ . This behaves as a phenol and an  $\alpha$ -amino-acid. On fusion with potassium hydroxide in an atmosphere of hydrogen, thyronine gives a mixture of *p*-hydroxybenzoic acid, quinol, oxalic acid and ammonia. When fused with potassium hydroxide at 250°, thyronine gives *p*-hydroxybenzoic acid, quinol and a compound with the molecular formula  $\text{C}_{13}\text{H}_{12}\text{O}_2$  (II). A structure for thyronine which would give all these products is I.

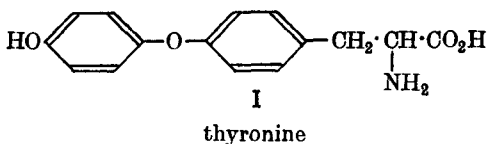

Thyronine (provisionally structure I) was subjected to the Hofmann exhaustive methylation (see §4. XIV) and the product thereby obtained was then oxidised. The final product would be III (on the assumption that I is thyronine).

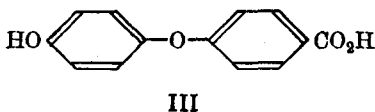

The structure of III was confirmed by synthesis, starting from *p*-bromoanisole and *p*-cresol.



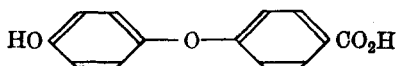
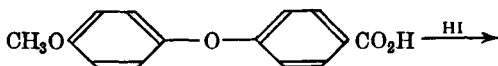
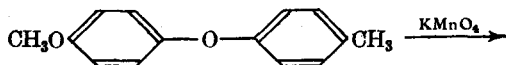
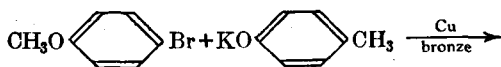

III

Furthermore, when 4-methoxy-4'-methylidiphenyl ether is heated with hydriodic acid, compound II ( $\text{C}_{13}\text{H}_{12}\text{O}_2$ ; see above) is obtained; thus the structure of II is also established.

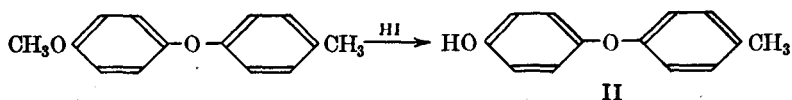

II

Now when thyroxine is fused with potassium hydroxide, no *p*-hydroxybenzoic acid is obtained; instead, compounds of the pyrogallol type are formed. These facts suggest that two atoms of iodine are adjacent to the hydroxyl group, and that the two remaining iodine atoms are in the other benzene ring. This, together with the analogy with di-iodotyrosine, leads to the suggestion that thyroxine is IV.

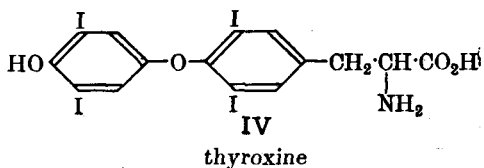

This structure for thyroxine has been confirmed by synthesis (Harington *et al.*, 1927).

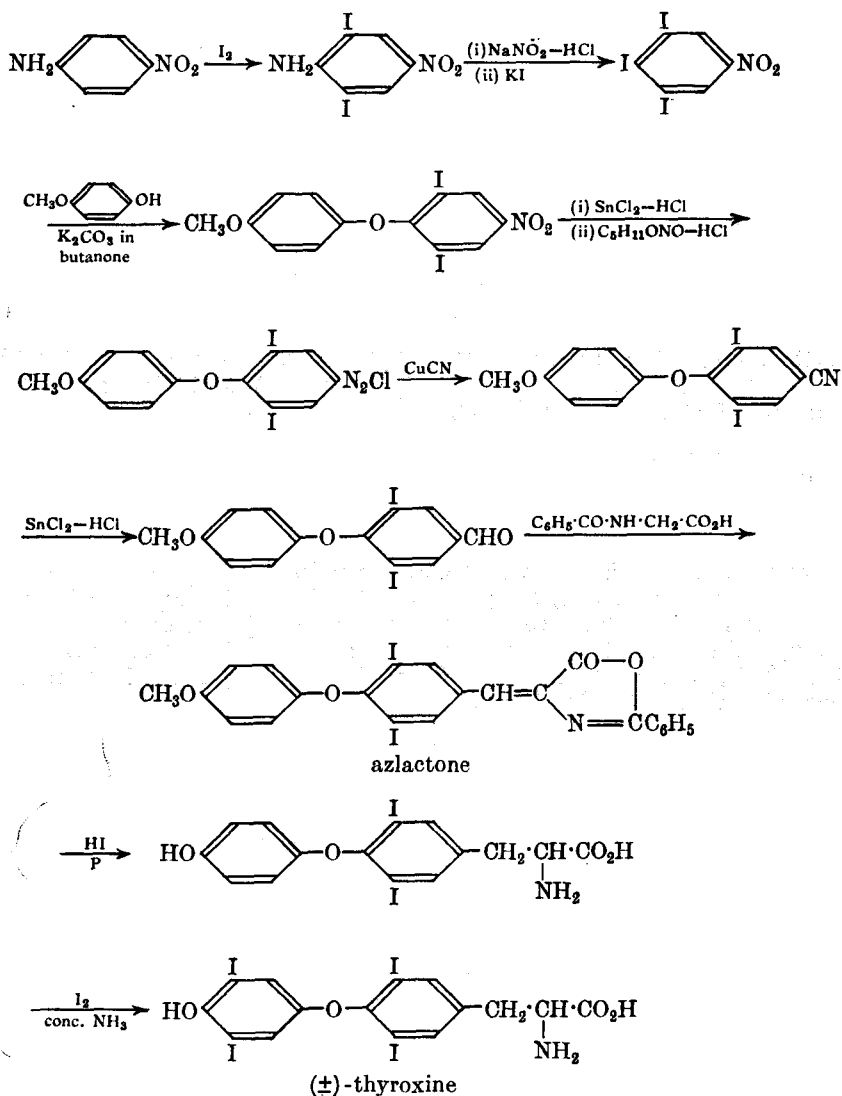

The racemic modification was resolved *via* the formyl derivative (Harington, 1938).

The synthesis of thyroxine has been improved, *e.g.*, by Hems *et al.* (1949).

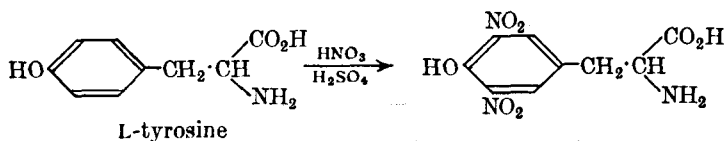

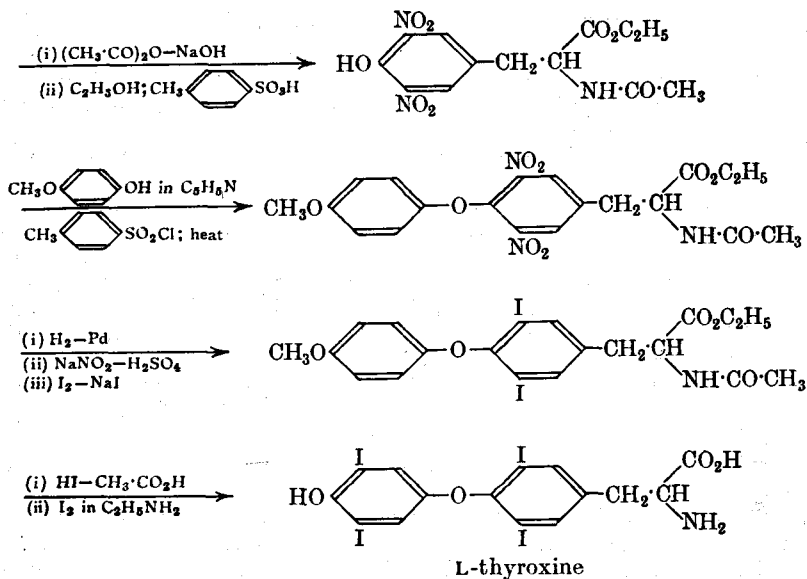

The thyroid gland also contains 3 : 5-di-iodotyrosine, and this compound is believed to be the precursor of thyroxine. Deficiency in thyroxine causes myxœdema.

### PROTEINS

**§6. General nature of proteins.** The name *protein* was introduced by Mulder (1839), who derived it from the Greek word *proteios* (meaning *first*). Proteins are nitrogenous substances which occur in the protoplasm of all animal and plant cells. Their composition varies with the source; an approximate composition may be given as: carbon, 47–50%; hydrogen, 6–7%; oxygen, 24–25%; nitrogen, 16–17%; sulphur, 0.2–0.3%. Other elements may also be present, *e.g.*, phosphorus (nucleoproteins), iron (hæmoglobin).

Proteins are colloids and have no characteristic melting points; some have been obtained in crystalline form. All proteins are optically active (lævorotatory), their activity arising from the fact that they are complex substances built up of amino-acids. It appears likely that all enzymes are proteins (see §12); many hormones are also proteins, *e.g.*, insulin.

Proteins may be coagulated, *i.e.*, precipitated irreversibly, by heat and by strong inorganic acids and bases, etc. When proteins are precipitated irreversibly, they are said to be *denatured*, but the chemical changes that occur in this process are still uncertain. The results of denaturation may be a change in any of the following properties: solubility, molecular shape and size, biological activity, or susceptibility to enzymic reactions. One point that appears to be reasonably certain is that a critical number of hydrogen bonds must be broken before irreversible denaturation can occur. Proteins may be precipitated by ethanol or concentrated solutions of ammonium sulphate or sodium chloride. In this case, the precipitation is reversible, *i.e.*, the precipitated proteins may be redissolved; thus they are not denatured by these reagents. Proteins are also precipitated by the salts of the heavy metals, *e.g.*, mercuric chloride, copper sulphate, etc., and they give many characteristic colour reactions with various reagents, *e.g.*,

(i) *Biuret reaction*. Addition of a very dilute solution of copper sulphate to an alkaline solution of a protein produces a red or violet colour.

(ii) *Millon's reaction*. When a solution of mercuric nitrate containing nitrous acid is added to a protein solution, a white precipitate is formed and slowly turns pink.

(iii) *Xanthoproteic reaction*. Proteins produce a yellow colour when treated with concentrated nitric acid.

Proteins are amphoteric, their behaviour as an anion or a cation depending on the  $pH$  of the solution. At some definite  $pH$ , characteristic for each protein, the solution contains equal amounts of anion and cation. In this condition the protein is said to be at its *isoelectric point*, and at this  $pH$  the protein has its least solubility, *i.e.*, it is most readily precipitated (*cf.* amino-acids, §4 C i). The osmotic pressure and viscosity of the protein solution are also a minimum at the isoelectric point. The amphoteric nature of proteins is due to the presence of a large number of free acidic and basic groups arising from the amino-acid units in the molecule. These groups can be titrated with alkali or acid, and by this means it has been possible to identify acidic and basic groups belonging to the various amino-acid units (see also §11).

The molecular weights of proteins have been determined by means of the ultracentrifuge, osmotic pressure measurements, X-ray diffraction, light scattering effects and by chemical analysis. Chemical methods are based on the estimation of a particular amino-acid, *e.g.*, casein contains cystine; hence the estimation of the percentage of this amino-acid and of sulphur will lead to the evaluation of the molecular weight of casein. The most reliable values of the molecular weights are those obtained by the ultracentrifuge method; the values recorded vary considerably for the individual proteins, ranging from about 40,000 for egg albumin to about 5,000,000 for hæmocyanin.

**§7. Classification of proteins.** Several arbitrary classifications of the proteins are in use. One method is based mainly on physical properties, particularly solubility.

**A. Simple proteins.** These give only amino-acids on hydrolysis.

(i) *Albumins*. These are soluble in water (and in acids and alkalis), and are coagulated by heat. They are precipitated by saturating their solutions with ammonium sulphate.

Albumins are usually low or deficient in glycine; some albumins are serum albumin, egg albumin and lactalbumin.

(ii) *Globulins*. These are insoluble in water, but are soluble in dilute salt solution and in dilute solutions of strong inorganic acids and alkalis. They are precipitated by half saturating their solutions with ammonium sulphate, and they are coagulated by heat.

Globulins usually contain glycine; some typical globulins are serum globulin, tissue globulin and vegetable globulin.

(iii) *Prolamines*. These are insoluble in water or salt solution, but are soluble in dilute acids and alkalis, and in 70-90 per cent. ethanol.

Prolamines are deficient in lysine, and contain large amounts of proline; some prolamines are zein (from maize), gliadin (from wheat) and hordein (from barley).

(iv) *Glutelins*. These are insoluble in water or dilute salt solution, but are soluble in dilute acids and alkalis; they are coagulated by heat.

Some glutelins are glutenin (from wheat) and oryzenin (from rice).

(v) *Scleroproteins (albuminoids)*. These are insoluble in water or salt solution, but are soluble in strong acids or alkalis.

Examples: keratin (from hair, hoof), fibroin (from silk); these are not attacked by enzymes.

Submembers of the scleroproteins are:

(a) *Collagens* (in skin, tendons and bones); these form gelatin (a water-soluble protein) when boiled with water. Collagens are attacked by pepsin or trypsin.

(b) *Elastins* (in tendons and arteries); these are not converted into gelatin, and are attacked slowly by trypsin.

(vi) *Basic proteins*. These are strongly basic, and fall into two groups.

(a) *Histones*. These are soluble in water or dilute acids, but are insoluble in dilute ammonia. They are not coagulated by heat, and contain large amounts of histidine and arginine. Histones are the proteins of the nucleic acids, hæmoglobin, etc.

(b) *Protamines*. These are more basic than the histones and have a simpler structure. They are soluble in water, dilute acids and dilute ammonia; they are not coagulated by heat, and are precipitated from solution by ethanol. They contain large amounts of arginine, and occur in various nucleic acids.

**B. Conjugated proteins** are proteins which contain a non-protein group (*i.e.*, a compound not containing amino-acid residues) attached to the protein part. The non-protein group is known as the *prosthetic group*, and it may be separated from the protein part by careful hydrolysis.

(i) *Nucleoproteins*. The prosthetic group is a nucleic acid.

(ii) *Chromoproteins*. These are characterised by the presence of a metal, *e.g.*, iron, magnesium, copper, manganese, cobalt, etc. Chromoproteins may also contain a coloured prosthetic group. Examples: chlorophyll and hæmoglobin.

(iii) *Glycoproteins*. In these the prosthetic group contains a carbohydrate or a derivative of the carbohydrates.

(iv) *Phosphoproteins*. These are conjugated proteins in which the prosthetic group contains phosphoric acid in some form other than in the nucleic acids or in the lipoproteins.

(v) *Lipoproteins*. In these the prosthetic group is lecithin, kephalin, etc.

(vi) *Metalloproteins*. These are heavy metal-protein complexes; all the heavy metals can form complex ions with proteins, *e.g.*, calcium caseinate occurs in blood.

**C. Derived proteins** are degradation products obtained by the action of acids, alkalis or enzymes on proteins.

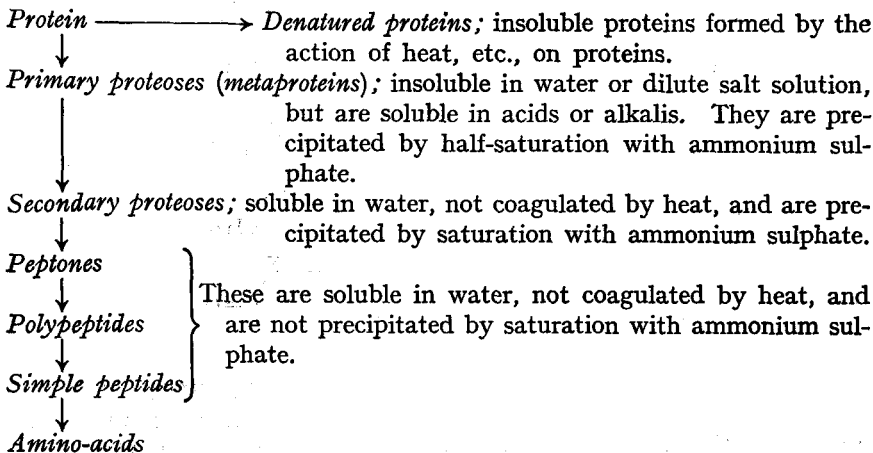

**§8. Structure of the proteins.** Proteins are hydrolysed by acids, alkalis or by suitable enzymes to a mixture of amino-acids. About twenty-five acids have been definitely isolated; all or only some of these acids may be present in a given protein, and their proportions vary from protein to protein. It appears that, in general, three or four types of amino-acid residues make up the bulk of a given protein molecule, and minor amounts of fifteen or more other acids are also present. Fischer (1902) and Hofmeister (1902) suggested that amino-acids in proteins are joined in a *linear* fashion by *peptide* linkages, *i.e.*, by the  $-\text{CO}\cdot\text{NH}-$  group, the carboxyl group of one amino-acid molecule forming an amide by combination with the amino-group of the next amino-acid molecule, etc. When a relatively small number of amino-acids are linked together (as amides), the resulting molecule is called a *peptide*. When a relatively large number of amino-acid residues are present in the molecule, then that compound is called a *polypeptide*. Proteins are far more complex than the polypeptides. Thus, on this basis, a protein molecule may be represented as a *linear polymer* of amino-acid molecules.

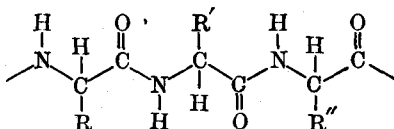

The examination of the infra-red absorption spectra of various synthetic polypeptides has shown the presence of the peptide (*i.e.*, amide) link, and that these links are at positions expected for them. Furthermore, it has been shown that proteins of the keratin type have bands characteristic of the peptide link (Darmon *et al.*, 1947).

Since some amino-acids contain two amino or two carboxyl groups, it is therefore possible to have *free* amino and carboxyl groups at various positions along the chain, *i.e.*, the group R may contain a free amino or carboxyl group. Since the hydrolysis of certain proteins leads to the formation of ammonia, it has been concluded that in addition to free amino and carboxyl groups, there are also some carbonamide groups,  $-\text{CONH}_2$ . X-ray analysis has confirmed the existence of these polypeptide chains and has shown that the amide group is generally planar. Furthermore, these chains are arranged in a three-dimensional lattice, the chains being held together, to a large extent, by hydrogen bonds. Infra-red studies have shown the presence of hydrogen bonding with NH groups and that the configuration of the substituted amide group is *trans* (see above structure).

On the other hand, when the protein contains cystine, the chains are

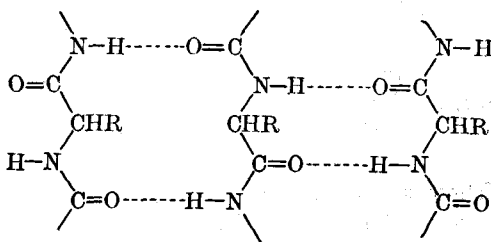

*cross-linked via sulphur* (*cf.* vulcanisation of rubber, §33a. VIII). The presence of this disulphide linkage has been definitely established, and it has been shown that this link may be broken by oxidation with performic acid

(Hirs, 1956), or by reduction (Sela *et al.*, 1957, 1959). In both cases, the rest of the molecule is unaffected.

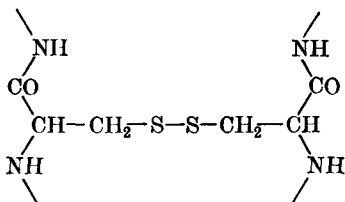

Proteins have been found to be of two types, *fibröus* and *globular*. In fibrous proteins the polypeptide chains are extended. In some cases, however, the chains are apparently "coiled", and these may be extended by the application of a force. The nature of the coiled structure is uncertain, but two configurations have been proposed which agree reasonably well with information obtained from infra-red spectra, X-ray data, bond lengths and bond energies. According to Ambrose *et al.* (1949), the polypeptide chain is folded into a series of seven-membered rings, the folds of the chain being stabilised by hydrogen bonding; in the natural fibre, a number of these folded chains are cross-linked (see above).

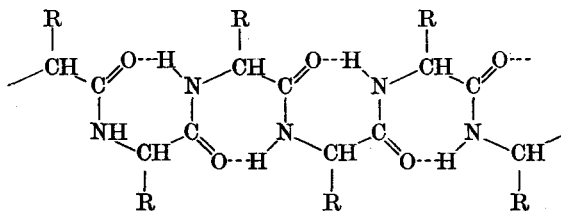

On the other hand, Pauling *et al.* (1951) have proposed a coiled chain in the form of a helix containing either 3·7 or 5·1 acid residues.

The folded (coiled) form of a fibrous protein is known as the  $\alpha$ -form, and the extended as the  $\beta$ -form. Elliott *et al.* (1951, 1953) have observed that the frequency of the CO stretching mode in synthetic polypeptides and natural proteins depends on the configuration of the polypeptide chain. Thus this offers a means of distinguishing between the  $\alpha$ - and  $\beta$ -forms.

It has been shown that in the solid state many synthetic polypeptides form stable helical structures which correspond closely to the  $\alpha$ -helix form. With other synthetic polypeptides, this  $\alpha$ -helical configuration appears to be less stable (Elliott *et al.*, 1960; Blout *et al.*, 1960). It has been shown that in poly- $\beta$ -benzyl-L-aspartate, steric interference between the side-chain and main-chain makes the  $\alpha$ -helical configuration fairly unstable (Elliott *et al.*, 1959, 1962). When this compound is heated, it adopts a new helical form, which has been termed the  $\omega$ -helix. Fraser *et al.* (1962) have prepared another polypeptide which, although not identical in form with that of the aspartate polymer, also is conveniently described as an  $\omega$ -helix.

The foregoing account of the structure of proteins is based on the long-accepted hypothesis that the peptide structure is universally valid. Recently, however, evidence has been obtained which indicates that this peptide hypothesis is inadequate. Wrinch (1957, 1960), from her examination of small peptides, showed that various observations that are anomalous in the peptide system can be accounted for by a hypothesis consisting of two postulates: (i) the amino-acid residues of peptides are united not only

in one-bond peptide grouping,  $-\text{CO}\cdot\text{NH}-$ , but also in the two-bond and three-bond peptide groupings:

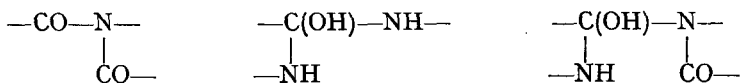

(ii) Various reactive side-groups make ring-closures; these in the case of the hydroxy and thiol amino-acids introduce two-bond groupings of the form:



This is known as the *cyclol hypothesis* (Wrinch, 1961).

Another point that complicates the problem of protein structure is the work of Brenner (1958, 1959), who has shown that rearrangements may occur between peptides, *e.g.*, between  $\text{O}\cdot\text{Gly}\cdot\text{N}\cdot\text{Bz}\cdot\text{Ser}\cdot\text{NH}_2$  and  $\text{N}\cdot\text{Bz}\cdot\text{Ser}\cdot\text{Gly}\cdot\text{NH}_2$  (see §11 for the meanings of these symbols).

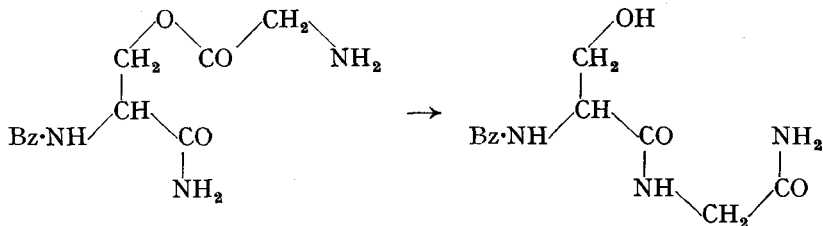

The globular (corpuscular) proteins are more compact than the fibrous proteins, but their shape is not spherical; *e.g.*, X-ray studies have shown that haemoglobin has a cylindrical shape. The chains in globular proteins are folded many times, and in order to account for certain properties, this folding must follow some definite pattern. An interesting point in connection with globular proteins is that infra-red methods may be used to detect the presence of carboxylate groups in them at the isoelectric point (Ehrlich *et al.*, 1954).

Of the two types of proteins, it is only the globular which have been obtained crystalline; the fibrous proteins lack the characteristics necessary for crystallisation. It appears that all protein crystals grown from solution contain solvent, the removal of which causes the protein to become less crystalline. The solvent has been shown to be interstitial and not "solvent of crystallisation".

One other point about the nature of these polypeptide chains will now be mentioned briefly. Let us consider a dipeptide composed of two *different* amino-acids, **A** and **B**. These may be combined in two different ways:

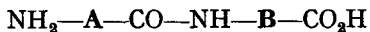

and

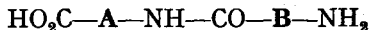

Three different amino-acids may be combined in six different ways. In general, with  $n$  different acids, there will be  $n!$  different combinations possible. Had not the naturally occurring amino-acids (excluding glycine) been all of the L-series, the total number of possible combinations would have been very much larger still. It is therefore of great interest to ascertain the "order" in which amino-acids are combined in proteins. Some progress has been made in this direction (see §11).



§9. **Synthesis of polypeptides.** Various methods have been introduced,

*e.g.*,

(i) The partial hydrolysis of a diketopiperazine with hydrochloric acid gives a dipeptide (Fischer, 1901), *e.g.*,

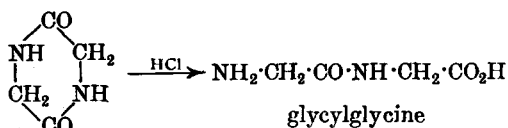

glycylglycine

2:5-diketopiperazine

Glycylglycine was the first peptide to be synthesised. The method is very limited in application, since only dipeptides may be prepared. If a "mixed" diketopiperazine is used, then hydrolysis can proceed in two different ways; the nature of the product depends on the hydrolysing agent used.

(ii) The methyl esters of di- and tri-peptides tend to eliminate methanol to form a higher peptide (Fischer, 1901).

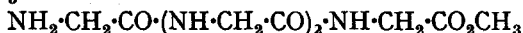
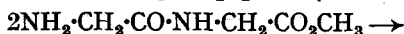

By means of this reaction, Frankel *et al.* (1942) prepared polypeptides containing up to 110 glycy units.

(iii) When two different amino-acids are joined to form a dipeptide, two possibilities occur (*cf.* §8); thus, if glycine and alanine are linked together, the two possibilities are:



and



In order to condense the two amino-acids in a known manner, Fischer (1901, 1903) "blocked" the amino-group of one molecule by first reacting that compound with ethyl chloroformate; thus:

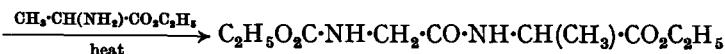
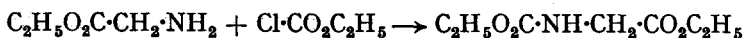

Hence by starting with glycylglycine, the diglycylalanine derivative may be prepared. The difficulty with this method, however, is that it is not possible to remove the *N*-carbethoxyl group by hydrolysis without also hydrolysing the peptide link. This difficulty was overcome by Fischer (1915) by using *p*-toluenesulphonyl chloride as the "blocking agent" instead of ethyl chloroformate; the former group can be removed (as the thiophenol) by warming with hydriodic acid, without hydrolysis of the peptide link, *e.g.*,

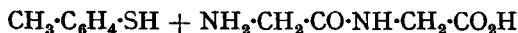
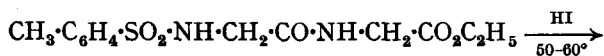
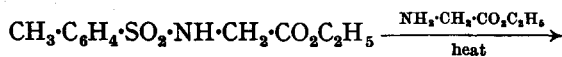

Bergmann (1932) found that benzyl chloroformate is a very good blocking agent, and its application is much wider than that of *p*-toluenesulphonyl chloride. Benzyl chloroformate is readily prepared by the action of carbonyl

chloride on benzyl alcohol in toluene solution (benzyl chloroformate is also known as carbobenzyloxy or benzyloxycarbonyl chloride):

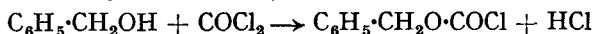

The procedure is then as follows:

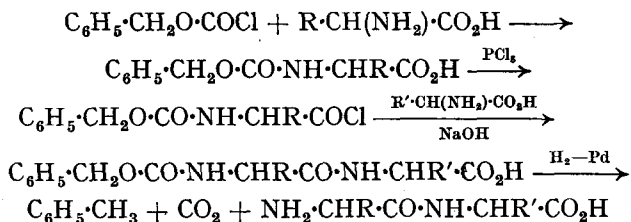

If the amino-acid contains sulphur, then catalytic reduction cannot be used, since the sulphur poisons the catalyst; the removal of the blocking group, however, may be successfully accomplished by means of phosphonium iodide or sodium in liquid ammonia.

A more recent and convenient method of removing the benzyloxycarbonyl group is to treat the derivative with hydrogen bromide in acetic acid or nitromethane (Ben-Ishai *et al.*, 1952; Anderson *et al.*, 1952):

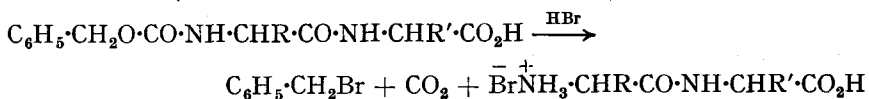

According to Weygand *et al.* (1959), boiling trifluoroacetic acid removes an *N*-benzyloxycarbonyl group without splitting peptide bonds or causing racemisation.

Weisblat *et al.* (1953) have also shown that the *p*-toluenesulphonyl group can be removed by means of hydrogen bromide in acetic acid containing phenol.

Stevens *et al.* (1950) have used allyl chloroformate instead of benzyl chloroformate, and then removed the carboallyloxy-group by means of sodium in liquid ammonia.

Sheehan *et al.* (1949) have used the following method for blocking the amino-group of one amino-acid residue (*cf.* Gabriel's phthalimide synthesis, §2 *ib.*).

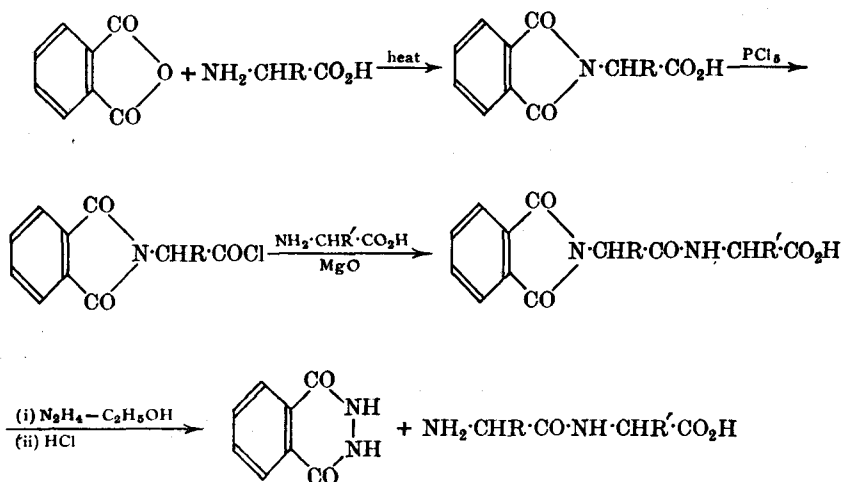

(iv) Polypeptides may be synthesised by combining an  $\alpha$ -halogenoacid chloride with an amino-acid ester and then proceeding as follows (Fischer, 1903).

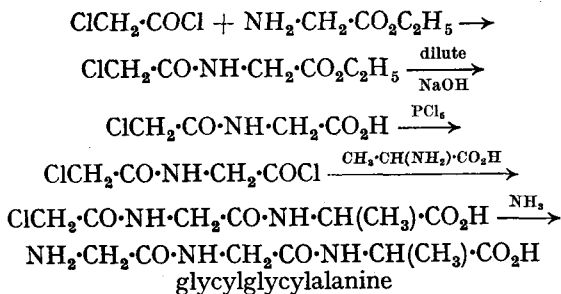

(v) A variation of the previous method is to convert an amino-acid into its corresponding acid chloride by means of phosphorus pentachloride in acetyl chloride, and then to treat the acid chloride with another molecule of an amino-acid (Fischer, 1907). In the formation of the acid chloride, hydrogen chloride is also produced, and this combines with the amino-group to form the group  $\bar{\text{Cl}}\{\text{H}_3\text{N}^+\cdot\text{CHR}\cdot$ , which is *not* acetylated by the acetyl chloride present; *e.g.*,

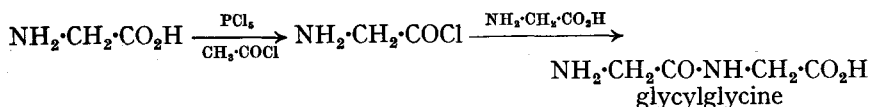

By this means Fischer (1907) succeeded in synthesising an octadecapeptide (of molecular weight 1213), and Abderhalden (1916) synthesised a nonadecapeptide (of molecular weight 1326).

(vi) The above methods involving the intermediate formation of an acid chloride cannot be applied to hydroxyamino- and di-amino-acids, since these acids react with phosphorus pentachloride in a complicated fashion and do not give the desired halogen compounds. In such cases Bergmann (1926) successfully applied the azlactone synthesis, *e.g.*,

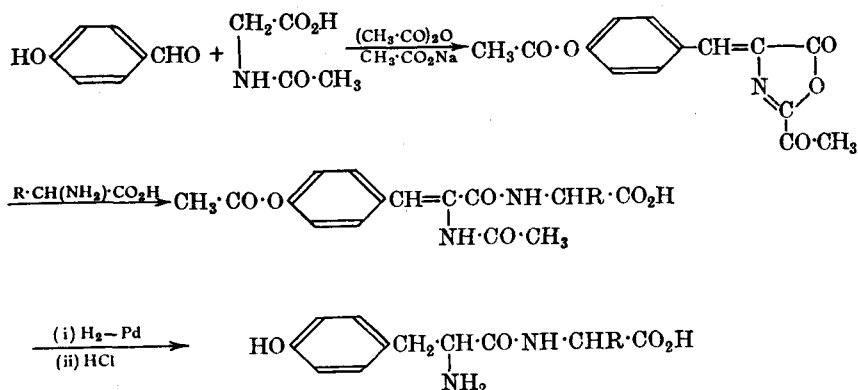

On the other hand, Beyerman *et al.* (1961) have used the *t*-butoxy group to protect the hydroxyl group in the synthesis of peptides containing hydroxy-amino-acids. This group is removed readily by acid without fission of the

peptide bond, and the optical activity is completely maintained during the process. The *t*-butoxy group is conveniently introduced by the acid-catalysed addition of isobutene to the hydroxy group of the *N*-acylated hydroxyamino-acid.

(vii) A very recent method of building up peptides is that of Schwyzer *et al.* (1955); this method involves the use of chloroacetonitrile as follows:

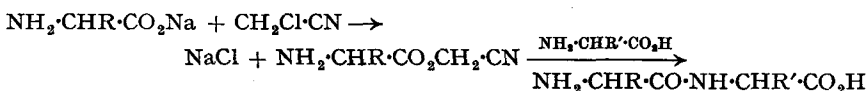

As we have seen (§4), all the amino-acids except glycine contain at least one asymmetric carbon atom. Furthermore, the  $\alpha$ -acylamino-acids are readily racemised, and hence a very important point about the syntheses described above is that racemisation will occur during the syntheses. The actual extent of racemisation depends on the nature of the acyl group and the type of condensation used. According to Boissonas *et al.* (1955), the benzyloxycarbonyl group gives very resistant derivatives (to racemisation) and is therefore the best one to use.

**§10. Properties of the polypeptides.** The polypeptides are solids which usually decompose when heated to 200–300°. They are soluble in water, but are insoluble in ethanol, and have a bitter taste similar to that of the proteins. They are hydrolysed by acids, alkalis and enzymes, and they very closely resemble the polypeptides actually obtained by the partial hydrolysis of proteins. Polypeptides (synthetic) also give the biuret test. Many peptides have been found as the products of metabolism of micro-organisms.

**§11. Degradation of the polypeptides.** It has already been pointed out that a necessary requirement for the elucidation of the structure of proteins is a knowledge of the "order" of the amino-acid residues in the molecule (§8). Chemical methods have been introduced whereby the *terminal* amino-acid residue of a polypeptide may be removed in a stepwise fashion. Consideration of the following structure of a polypeptide shows that the two ends of the molecule are not alike; the end on the left-hand side is known as the "amino-end", and that on the right-hand side as the "carboxyl-end"; the former is said to be *N*-terminal and the latter *C*-terminal.

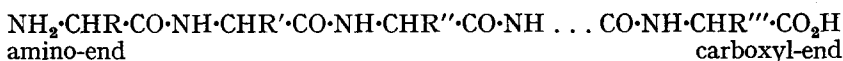

Methods have been introduced for degrading either the carboxyl-end or the amino-end of the polypeptide chain, *e.g.*,

**Carboxyl-end degradation.** The following method is due to Schlack and Kumpf (1926).

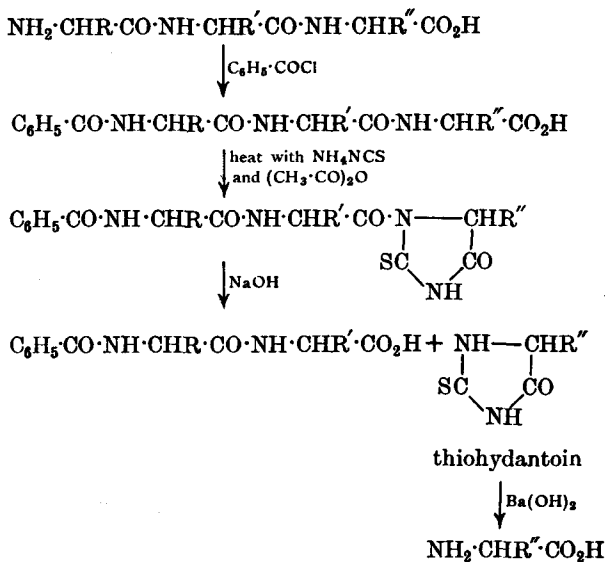

Thus the terminal amino-acid can be identified, and the process can now be repeated on the degraded peptide.

Reduction of proteins with lithium aluminium hydride (or lithium borohydride) converts the free terminal carboxyl group to a primary alcoholic group (*cf.* §4b). Hydrolysis produces an amino-alcohol, which is then identified.

Hydrazinolysis is also used (Akabori *et al.*, 1956). Treatment of a protein with hydrazine converts all amino-acids, except the C-terminal one, into hydrazides.

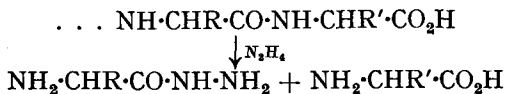

Treatment of the product with benzaldehyde converts the hydrazides into hydrazones. The terminal amino-acid, which is unaffected by this treatment, is converted into its "DNP" derivative (see below).

Another method makes use of the enzyme carboxypeptidase. This enzyme attacks proteins at the end which contains the free carboxyl group. Thus the chain is gradually degraded.

**Amino-end degradation.** The following method is due to Edman (1950) (see overleaf).

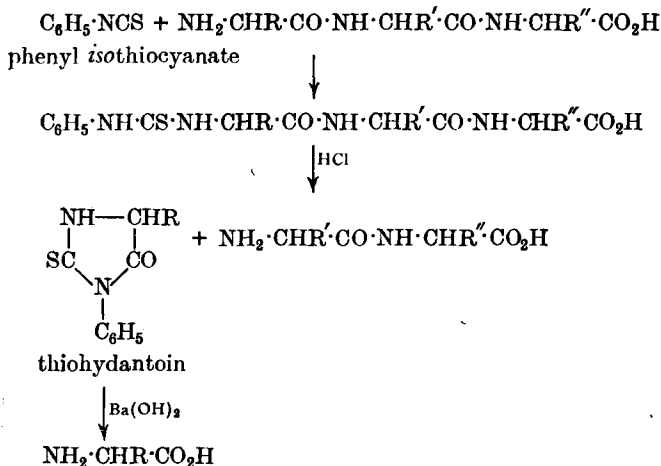

Thus the terminal amino-acid can be identified, and the process can now be repeated on the degraded peptide.

More recently, Asai *et al.* (1955) have investigated the infra-red spectra of polypeptides and have shown that certain bands depend largely on the *sequence* of the amino-acids in the chain. These authors have concluded that the crystalline part of silk fibroin contains glycine and alanine residues arranged alternately.

Another interesting point about the structure of polypeptides is the nature of the amino-acids in the chain which have free amino groups (*cf.* §6). Sanger (1945) has developed the "DNP" method for solving this problem. He showed that 1-fluoro-2:4-dinitrobenzene reacts readily only with amino groups and forms derivatives which are stable to acids, *e.g.*,

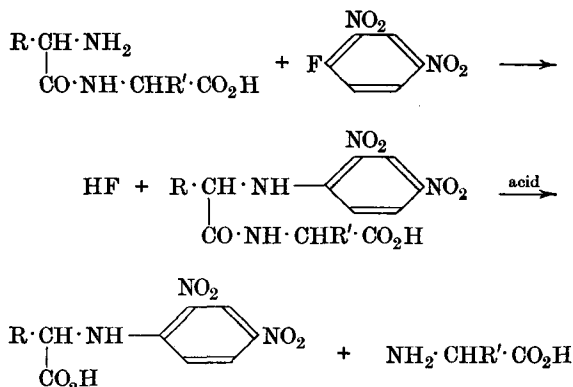

Thus, when a peptide is first treated with the reagent and then the product hydrolysed with acid, a number of amino-acids will be obtained as their dinitrophenyl derivatives (which can be separated by chromatography; *cf.* §3).

The methods described above for determining the sequence are chemical, but enzymic methods have also given a great deal of information on this problem, *e.g.*, trypsin attacks peptide bonds to which an L-arginine or L-lysine residue has contributed the carboxyl group. Enzymic and chemical methods used together have been extremely valuable.

The exact sequence of amino-acid residues has been worked out only for the hormone insulin, the enzyme ribonuclease, and for the unit protein of the tobacco mosaic virus. The arrangement of the acid residues is random, and consequently synthesis is made difficult.

In protein chemistry, to facilitate writing out the amino-acid sequence, the general practice is to use the first three letters of the names of the acids as abbreviations. When the sequence is not known, the abbreviations are enclosed in brackets, but the *N*- and *C*-terminal residues may be differentiated from residues within the chain by H and OH respectively, *e.g.*,

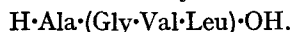

## ENZYMES

**§12. General nature of enzymes.** Enzymes are biological catalysts which bring about chemical reactions in living cells. They are produced by the living organism, and are usually present in only very small amounts in the various cells (about 0.01 per cent.). They can also exhibit their activity even when they have been extracted from their source. The enzymes are all organic compounds, and a number of them have been obtained in a crystalline form. Those so far obtained crystalline are proteins and have very high molecular weights. Most enzymes are colourless solids, but some are yellow, blue, green or greenish-brown; most are soluble in water or dilute salt solution. Some enzymes are purely protein in nature, but many contain a prosthetic group (see §7 B) which has a relatively low molecular weight. The prosthetic group of some enzymes is readily separated (*e.g.*, by dialysis) from the protein part and the latter, in this condition, is known as an *apoenzyme*, *e.g.*, peroxidase is composed of hæmatin (prosthetic group; see §2. XIX) linked with the protein (the apoenzyme). The prosthetic group is often referred to as the co-enzyme (when dealing with enzymes); both parts must be present for the "enzyme" to act. The conjugated protein, *i.e.*, apoenzyme + prosthetic group, has been designated as the *holoenzyme*.

**§13. Nomenclature.** The systematic method of naming enzymes is to add the suffix *ase* to the name of the *substrate*, *i.e.*, the substance being acted upon, *e.g.*, esterase acts on esters, amylase on starch (*amylum*), protease on proteins, urease on urea, etc. Some enzymes, however, have retained their trivial names, *e.g.*, emulsin, pepsin, trypsin, etc. Names are also used for *particular* enzymes, *e.g.*, urease, amylase, or as *general* names for *groups* of enzymes, *e.g.*, esterases, proteases, etc. Enzymes of various species are quite often similar, and the reactions catalysed by them are identical. Even so, it does not necessarily follow that these enzymes are identical chemically, *e.g.*, amylases from different sources have different *pH* optima (see below).

**§14. Classification of enzymes.** Enzymes are usually classified on the type of reaction which they catalyse. There are two main groups:

(i) *Hydrolytic enzymes*. These bring about hydrolysis, *e.g.*, proteases (proteins), lipases (esters), carbohydrases (carbohydrates), etc.

(ii) *Oxidative enzymes*. Most oxidative enzymes function by transferring hydrogen from the substrate (or a modified form, *e.g.*, a hydrated form) to themselves, *i.e.*, they behave as hydrogen acceptors. These enzymes are known as *dehydrogenases*. There are also a few enzymes which oxidise the substrate directly with molecular oxygen; these are known as *oxidases*, *e.g.*, *ascorbic acid oxidase* catalyses the oxidation of ascorbic acid to dehydro-ascorbic acid by molecular oxygen (*cf.* §11. VII).

Some other types of enzymes are isomerising enzymes, transferring enzymes (*e.g.*, transaminases catalyse the transfer of an amino group of an

amino-acid to a keto group of a keto-acid), and "splitting enzymes" (*e.g.*, decarboxylases catalyse decarboxylation).

**§15. Conditions for enzyme action.** A number of factors influence enzyme activity: the concentration of the enzyme, the concentration of the substrate, the *pH* of the solution and the temperature. The optimum conditions for a particular enzyme must be found experimentally. The optimum *pH* varies considerably for individual enzymes, and for a given enzyme, with the nature of the substrate. The optimum temperature for animal enzymes is usually between 40° and 50°, and that for plant enzymes 50° and 60°. Most enzymes are irreversibly destroyed when heated above 70–80°.

Many enzymes have been shown to be reversible in their action, *i.e.*, they can both degrade and synthesise. The optimum conditions, however, for degradation are very often totally different from those for synthesis. Furthermore, it does not follow that synthesis in the organism is effected by the same enzyme which produces degradation, *e.g.*, urea is hydrolysed by urease in plants, but is formed in animals by the action of arginase on the amino-acid arginine.

**§16. Specificity of enzyme action.** One of the most characteristic properties of enzymes is their specificity of action. This specificity may be manifested in one of three ways:

(i) Specificity for a particular reaction or a particular type of reaction, *e.g.*, urease will hydrolyse only urea; esterases hydrolyse only esters. Enzymes may also be specific within a group, *e.g.*, phosphatases (a group of esterases) only hydrolyse esters in which the acid component is phosphoric acid.

(ii) Many enzymes exhibit a *relative specificity*, *e.g.*, esterases, although hydrolysing all esters, hydrolyse the various esters at *different* speeds; pepsin hydrolyses the peptide link, but is most active for those links in which, among other things, the amino group belongs to an aromatic amino-acid and the carboxyl group is one of a dicarboxylic amino-acid.

(iii) Many enzymes are *stereospecific*, *e.g.*, maltase hydrolyses  $\alpha$ -glycosides but not  $\beta$ -glycosides, whereas emulsin hydrolyses the latter but not the former (*cf.* §3. VII).

It should be noted, however, that a given enzyme can exhibit more than one of the specificities, *e.g.*, esterases, while hydrolysing only esters, may also hydrolyse one enantiomorph (of an optically active ester) more rapidly than the other.

Another point of interest here is that the general type of reaction catalysed by an enzyme depends on the nature of the prosthetic group, and the specificity of the enzyme depends on the nature of the apoenzyme (protein).

**§17. Mechanism of enzyme action.** According to one view, enzymes initiate the reaction, but according to another view, the reaction catalysed by an enzyme is capable of proceeding at a very slow rate in the absence of the enzyme (*cf.* the theories of catalysis).

The details of the mechanism of the catalysis effected by enzymes are still not certain. A highly favoured theory is that the enzyme passes through a transition state by combination with its substrate, and then the enzyme is regenerated with the simultaneous formation of the products (*cf.* the transition state, Vol. I). A number of these transition states have been shown to exist from, *e.g.*, spectroscopic evidence; during the reaction the absorption spectrum of the enzyme is altered. It is also believed that the protein part of the enzyme has an "active centre", and it is this which combines with the substrate. Assuming this be the case, it is now necessary to explain why neither the protein part of the enzyme nor the prosthetic group can act separately, but both must be present (apparently in



combination). The answer to this question has been given in certain cases, *e.g.*, with dehydrogenases it has been suggested that the function of the prosthetic group is to act as a hydrogen acceptor, and that the function of the protein part of the enzyme is to "facilitate" the transfer of the hydrogen from the activated complex. It appears that the usual dehydrogenase action occurs in a number of steps involving different enzymes acting as hydrogen acceptors. Thus each enzyme undergoes reversible reduction and oxidation, and finally the last step is catalysed by cytochrome which is reduced, and this is reoxidised to cytochrome (and water) by molecular oxygen by means of *cytochrome oxidase*. The sequence may therefore be represented:

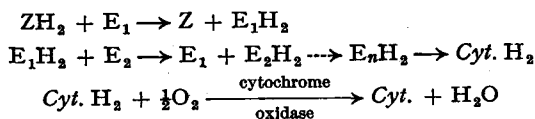

Most of the dehydrogenases contain a prosthetic group (which is the hydrogen acceptor). Thus a number of vitamins (§1. XVII) function as part of prosthetic groups, *e.g.*, pyridino-enzymes (pyridine nucleus), flavo-enzymes (riboflavin), etc. On the other hand, cytochrome and catalase are hæm-containing enzymes, and ascorbic acid oxidase and phenolase are copper protein enzymes.

When small molecules are converted into large molecules containing more energy than the units from which they were built, then energy must be supplied to bring about these syntheses. Enzymes are involved in these syntheses, and it is believed that certain organic compounds contain *energy-rich phosphate bonds*, and when dephosphorylation occurs energy is liberated, *e.g.*, acetyl phosphate contains such a bond (the symbol  $\sim$  is used to represent an energy-rich bond):

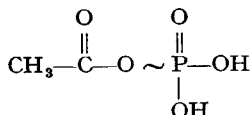

Many enzymes are inactive unless an *activator* is present. The inactive enzyme is known as a *zymogen*, and the activator as a *kinase* (if this is inorganic), *e.g.*, trypsinogen (the zymogen) together with enterokinase (the kinase) forms the enzyme trypsin. Some activators may be metallic or non-metallic, *e.g.*, salivary amylase requires chloride ions for activity. Activators, however, are not co-enzymes. Originally, co-enzymes were understood to include a small number of *organic* compounds of relatively low molecular weight which are required in catalytic amounts in enzyme reactions; the co-enzymes have no enzymic properties of their own. This description of a co-enzyme, however, is now losing this "definition"; most of the metalloporphyrin catalysts [*i.e.*, the so-called prosthetic groups (§12)] are covered by the foregoing definition. On the other hand, nucleotide co-enzymes are only catalytic in enzyme reactions in which they can be regenerated continuously. From this point of view, it would seem that a co-enzyme behaves as a substrate for the "true" enzyme (*cf.* dehydrogenases above).

Many substances may behave as *inhibitors*, *i.e.*, in their presence the enzyme fails to act; *e.g.*, saccharase is inactivated by copper ions (*cf.* "poisons" in catalysis). Sometimes purely physical means may inactivate an enzyme, *e.g.*, crystalline pepsin is inactivated by sound waves with a frequency of 9 kilocycles per second.

§18. **Biosynthesis of amino-acids and proteins.** First let us consider the *Krebs cycle* (1937). This is also known as the *citric acid cycle* and is the scheme proposed for the biological oxidation of hexoses to carbon dioxide and water. The first step is the conversion of a hexose molecule into two molecules of pyruvic acid; this occurs *via* the formation of phosphoglycer-aldehyde (*cf.* §23a. VII). The pyruvic acid combines with carbon dioxide to form oxalacetic acid:

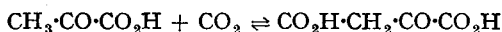

The Krebs cycle may then be written as follows (the various enzymes involved and mechanisms are not shown):

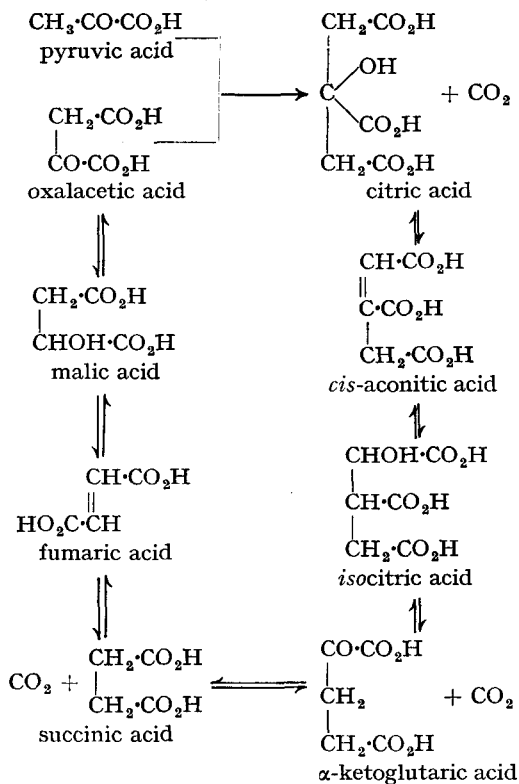

Amino-acids can be deaminated to keto-acids, and in addition to the general (amino-acid) dehydrogenases, there is a specific *glycine dehydrogenase* and a specific *glutamic dehydrogenase*. The case of glutamic acid is extremely important, since there is much evidence to show that this acid plays a vital part in the metabolism of amino-acids. Furthermore, it appears that the conversion of glutamic acid into  $\alpha$ -ketoglutaric acid is the only *reversible* reaction in the oxidative deamination of amino-acids.

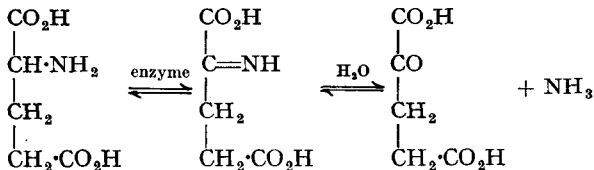

Keto-acids produced by deamination of amino-acids may undergo further transformations, one being their conversion into amino-acids. This, however, occurs by the process of transamination under the influence of *transaminases*, e.g.,

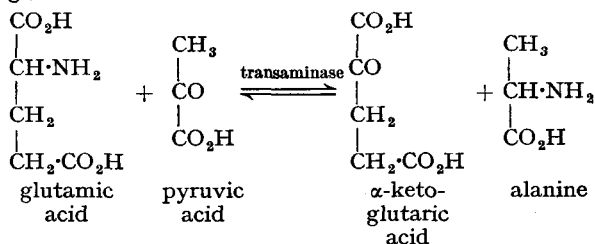

We have already seen (§32a. VIII) how various keto-acids could be synthesised in the organism. Thus, with the formation of  $\alpha$ -ketoglutaric acid from the break-down of carbohydrates, its *direct* amination to glutamic acid, and the latter now capable of aminating other keto-acids by transamination, the cycle of events is set up for the biosynthesis of amino-acids in general. A point to be noted in this connection is that some amino-acids are essential (§1), e.g., man cannot synthesise the benzene ring. Since, however, plants and bacteria synthesise aromatic compounds, a great deal of work has been carried out to elucidate the possible pathways. Two distinct routes have been recognised: (i) from acetate; (ii) from carbohydrates. The latter is believed to be the more important, and Davis *et al.* (1955, 1958), from their work with bacteria, have proposed the following route for the biosynthesis of phenylalanine and tyrosine; the two starting materials are phosphoenol pyruvate and D-erythrose 4-phosphate (P = ortho-phosphate residue):

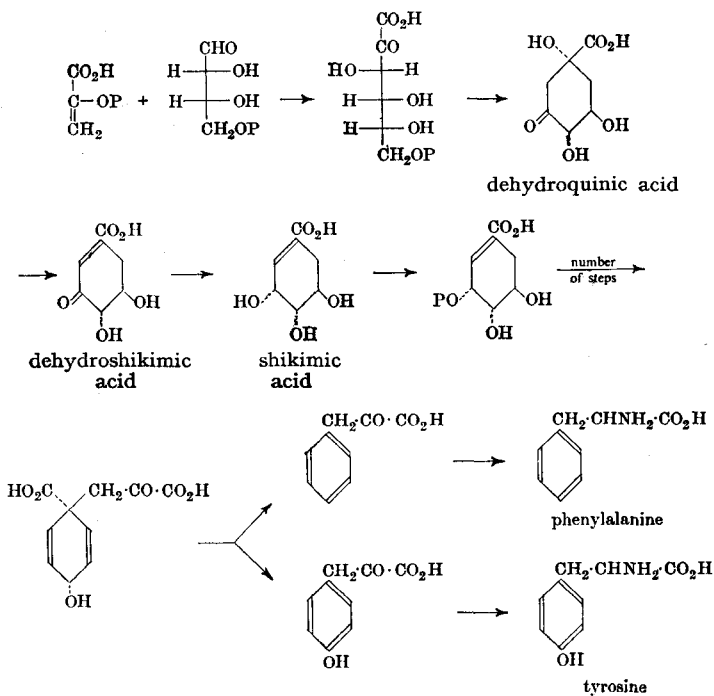

3-Deoxy-D-arabinoheptulosonic acid has been isolated (Srinivasan *et al.*, 1959); in one stage (labelled *no. of steps*), the nature of the intermediates is not certain.

The shikimic acid pathway is also believed to operate in higher plants (Higuchi, 1958); some alkaloids are believed to be products of this pathway (see §28. XIV). Flavonoids are believed to be derived from both the acetate and shikimic acid pathways (see §14b. XV).

A very interesting problem related to the biosynthesis of amino-acids is the work of Miller (1953, 1955). This author subjected a mixture of methane, ammonia, hydrogen and water vapour (which possibly made up the atmosphere of the Earth in its early stages) to spark and silent discharges. Analysis of the gases showed that the initial gases were present and, in addition, carbon monoxide, carbon dioxide and nitrogen. The solid product was analysed by means of paper chromatography, and the following amino-acids were identified: glycine, sarcosine (*N*-methylglycine), D- and L-alanine,  $\beta$ -alanine, D- and L- $\alpha$ -amino-*n*-butyric acid and  $\alpha$ -amino-isobutyric acid. Many other amino-acids (unidentified) were also formed, as well as formic, acetic, propionic, glycollic and lactic acids.

Bahadur (1954), on the other hand, has synthesised amino-acids by exposing a solution of paraformaldehyde and potassium nitrate to bright sunlight. Oró *et al.* (1961) have prepared amino-acids from hydrogen cyanide (see also §11a. XVI).

Finally, let us consider the biosynthesis of the proteins from amino-acids. Many workers have concluded that there are no intermediates, *i.e.*, protein synthesis is an "all-at-once" assembly of amino-acids. On the other hand, other workers have concluded that intermediates are formed, but these are so poorly defined or are so transient that they cannot be characterised. Steinberg *et al.* (1951-), using amino-acids labelled with  $^{14}\text{C}$ , have shown that their results are compatible with the step-wise mechanism through intermediates. On the other hand, it is generally accepted that nucleic acids serve as matrices for protein synthesis; the D.N.A. (§13. XVI) is considered to be the master pattern, whereas the R.N.A. acts as the working matrix.

#### READING REFERENCES

- Schmidt, *The Chemistry of the Amino-Acids and Proteins*, Thomas (1943, 2nd ed.).  
 Sahyum (Ed.), *Outline of the Amino-Acids and Proteins*, Reinhold (1948, 2nd ed.).  
 Gilman (Ed.), *Advanced Organic Chemistry*, Wiley. Vol. II (1943, 2nd ed.). Ch. 14. Natural Amino-Acids.  
 Rodd (Ed.), *Chemistry of Carbon Compounds*, Elsevier. Vol. 1B (1952). Ch. 22. Proteins.  
 Greenberg (Ed.), *Amino-Acids and Proteins*, Thomas (1951).  
 Haurowitz, *Chemistry and Biology of Proteins*, Academic Press (1950).  
 Springall, *The Structural Chemistry of Proteins*, Butterworth (1954).  
*Advances in Protein Chemistry*, Academic Press (1944- ).  
 Syngé, Naturally Occurring Peptides, *Quart. Reviews (Chem. Soc.)*, 1949, **3**, 245.  
 Khorana, Structural Investigation of Peptides and Proteins, *Quart. Reviews (Chem. Soc.)*, 1952, **6**, 340.  
 Asimov, Potentialities of Protein Isomerism, *J. Chem. Educ.*, 1954, **31**, 125.  
 Springall and Law, Peptides: Methods of Synthesis and Terminal-Residue Studies, *Quart. Reviews (Chem. Soc.)*, 1956, **10**, 230.  
*Progress in Organic Chemistry*, Butterworths. Vol. 4 (1958). Degradation and Synthesis of Peptides and Proteins, p. 140.  
*Advances in Organic Chemistry*, Interscience. Vol. I (1960). Thompson, The Selective Degradation of Proteins, p. 149.  
 Kenner, Recent Progress in the Chemistry of Peptides, *J.C.S.*, 1956, 3689.  
 Steinberg *et al.*, Kinetic Aspects of Assembly and Degradation of Proteins, *Science*, 1956, **124**, 389.  
 Sumner and Somers, *Chemistry and Methods of Enzymes*, Academic Press (1947, 2nd ed.).  
 Sumner, Enzymes, The Basis of Life, *J. Chem. Educ.*, 1952, **29**, 114.

- Avison and Hawkins, The Role of Phosphoric Esters in Biological Reactions, *Quart. Reviews (Chem. Soc.)*, 1951, **5**, 171.
- Klyne (Ed.), *Progress in Stereochemistry*, Butterworth (1954). (i) Ch. 7. The Stereochemistry of Compounds of High Molecular Weight. (ii) Ch. 8. Stereospecificity of Enzyme Reactions.
- Newer Methods of Preparative Organic Chemistry*, Interscience Publishers (1948). The Use of Biochemical Oxidations and Reductions for Preparative Purposes (pp. 159-196).
- Challenger, Biological Methylation, *Quart. Reviews (Chem. Soc.)*, 1955, **9**, 255.
- Miller, Production of Some Organic Compounds under Possible Primitive Earth Conditions, *J. Amer. Chem. Soc.*, 1955, **77**, 2351.
- Downes, *The Chemistry of Living Cells*, Longmans, Green (2nd ed., 1963).
- Dixon and Webb, *Enzymes*, Longmans, Green (1958).
- Baddiley and Buchanan, Recent Developments in the Biochemistry of Nucleotide Coenzymes, *Quart. Reviews (Chem. Soc.)*, 1958, **12**, 152.
- Roth, Ribonucleic Acid and Protein Synthesis, *J. Chem. Educ.*, 1961, **38**, 217.
- Neilands and Rogers, Progress in Enzyme Chemistry, *J. Chem. Educ.*, 1962, **39**, 152.
- Thompson, Classification and Nomenclature of Enzymes and Coenzymes, *Nature*, 1964, **193**, 1227.

**§1. Definition of an alkaloid.** Originally the name **alkaloid** (which means alkali-like) was given to *all organic bases isolated from plants*. This definition covers an extraordinary wide variety of compounds, and as the study of "alkaloids" progressed, so the definition changed. Königs (1880) suggested that alkaloids should be defined as naturally occurring organic bases which contain a pyridine ring. This definition, however, embraces only a limited number of compounds, and so the definition was again modified a little later by Ladenburg, who proposed to define alkaloids as natural plant compounds having a basic character and containing at least one nitrogen atom in a heterocyclic ring. Ladenburg's definition excludes any synthetic compounds and any compounds obtained from animal sources. One must admit that even today it is still difficult to define an alkaloid. The term is generally limited to organic bases formed in plants. Not all authors do this, and so they specify those alkaloids obtained from plants as *plant alkaloids* (or *vegetable alkaloids*). On the whole, alkaloids are very poisonous, but are used medicinally in very small quantities. Thus we find that the basic properties, physiological action and plant origin are the main characters which define plant alkaloids. Even so, the class of compounds known as the *purines* (Ch. XVI), which possess the above characters, are not usually included under the heading of alkaloids (some purines are also obtained from animal sources).

It is interesting to note in this connection that Sertürner (1806) isolated a basic compound from opium. Up to that time it was believed that plants produced only acids or neutral compounds.

**§2. Extraction of alkaloids.** In general, the plant is finely powdered and extracted with ethanol. The solvent is then distilled off, and the residue treated with dilute inorganic acids, whereupon the bases are extracted as their soluble salts. The free bases are liberated by the addition of sodium carbonate and extracted with various solvents, *e.g.*, ether, chloroform, etc. The mixtures of bases thus obtained are then separated by various methods into the individual compounds. More recent methods of extraction involve the use of chromatography. Lee (1960) has converted plant alkaloids into their reineckates, dissolved these in acetone, and passed this solution through an ion-exchange column, and thereby obtained the alkaloids in a high state of purity. (Reinecke's solution is  $\text{H}[\text{Cr}(\text{NH}_3)_2(\text{SCN})_4]$ .)

**§3. General properties.** The alkaloids are usually colourless, crystalline, non-volatile solids which are insoluble in water, but are soluble in ethanol, ether, chloroform, etc. Some alkaloids are liquids which are soluble in water, *e.g.*, coniine and nicotine, and a few are coloured, *e.g.*, berberine is yellow. Most alkaloids have a bitter taste and are optically active. They are generally tertiary nitrogen compounds and contain one or two nitrogen atoms usually in the tertiary state in a ring system; most of the alkaloids also contain oxygen. The optically active alkaloids are very useful for resolving racemic acids. The alkaloids form insoluble precipitates with solutions of phosphotungstic acid, phosphomolybdic acid, picric acid, potassium mercuri-iodide, etc. Many of these precipitates have definite crystalline shapes and so may be used to help in the identification of an alkaloid.

#### §4. General methods for determining structure.

(i) After a pure specimen has been obtained it is subjected to qualitative analysis (invariably the alkaloid contains (carbon), hydrogen and nitrogen; most alkaloids also contain oxygen). This is then followed by quantitative analysis and thus the empirical formula is obtained; determination of the molecular weight finally leads to the molecular formula. If the alkaloid is optically active, its specific rotation is also measured.

(ii) When an alkaloid contains oxygen, the functional nature of this element is determined:

(a) *Hydroxyl group.* The presence of this group may be ascertained by the action of acetic anhydride, acetyl chloride or benzoyl chloride on the alkaloid (acylation must usually be considered in conjunction with the nature of the nitrogen also present in the molecule; see iii). When it has been ascertained that hydroxyl groups are present, then their number is also estimated (by acetylation, etc.). The next problem is to decide whether the hydroxyl group is alcoholic or phenolic. It is phenolic if the alkaloid is soluble in sodium hydroxide and reprecipitated by carbon dioxide; also a coloration with ferric chloride will indicate the presence of a phenolic group. If the compound does not behave as a phenol, then the hydroxyl group may be assumed to be alcoholic, and this assumption may be verified by the action of dehydrating agents (most alkaloids containing an alcoholic group are readily dehydrated by sulphuric acid or phosphorus pentoxide). The behaviour of the compound towards oxidising agents will also disclose the presence of an alcoholic group.

(b) *Carboxyl group.* The solubility of the alkaloid in aqueous sodium carbonate or ammonia indicates the presence of a carboxyl group. The formation of esters also shows the presence of a carboxyl group.

(c) *Oxo group.* The presence of an oxo group is readily ascertained by the formation of an oxime, semicarbazone and phenylhydrazone.

(d) Hydrolysis of the alkaloid and an examination of the products lead to information that the compound is an ester, lactone, amide, lactam or a betaine.

(e) The *Zerewitinoff active hydrogen determination* may be applied to the alkaloid (see Vol. I).

(f) *Methoxyl group.* The presence of methoxyl groups and their number may be determined by the *Zeisel method*. The alkaloid is heated with concentrated hydriodic acid at its boiling point (126°); the methoxyl groups are thereby converted into methyl iodide, which is then absorbed by ethanolic silver nitrate and the silver iodide is weighed. Only methoxyl groups have been found in natural alkaloids.

(g) *Methylenedioxy group* ( $-\text{O}\cdot\text{CH}_2\cdot\text{O}-$ ). The presence of this group is indicated by the formation of formaldehyde when the alkaloid is heated with hydrochloric or sulphuric acid.

(iii) *The functional nature of the nitrogen.*

(a) The general reactions of the alkaloid with acetic anhydride, methyl iodide and nitrous acid often show the nature of the nitrogen.

(b) Distillation of an alkaloid with aqueous potassium hydroxide usually leads to information regarding the nature and number of alkyl groups attached to nitrogen. The formation (in the volatile products) of methylamine, dimethylamine or trimethylamine indicates respectively the attachment of one, two or three methyl groups to a nitrogen atom; the formation of ammonia shows the presence of an amino group. Only *N*-methyl groups have been shown to be present in alkaloids with one exception, *viz.*, aconitine, which contains an *N*-ethyl group.

(c) The presence of *N*-methyl groups and their number may be determined by means of the *Herzig-Meyer method*. When the alkaloid is heated

with hydriodic acid at 150–300° under pressure, *N*-methyl groups are converted into methyl iodide (*cf.* the Zeisel method, *ii*f).

(*d*) The results of hydrolysis will show the presence of an amide, lactam or betaine (*cf.* *ii*d).

(*e*) *Hofmann's exhaustive methylation method* (1881) is a very important process in alkaloid chemistry, since by its means heterocyclic rings are opened with the elimination of nitrogen, and the nature of the carbon skeleton is thereby obtained. The general procedure is to hydrogenate the heterocyclic ring (if this is unsaturated), then convert this compound to the quaternary methylammonium hydroxide which is then heated. In this last stage a molecule of water is eliminated, a hydrogen atom *in the β-position* with respect to the nitrogen atom combining with the hydroxyl group, and the ring is opened at the nitrogen atom on the *same* side as the *β*-hydrogen atom eliminated. The process is then repeated on the product; this results in the complete removal of the nitrogen atom from the molecule, leaving an unsaturated hydrocarbon which, in general, isomerises to a *conjugated* diene (see also Vol. I); *e.g.*,

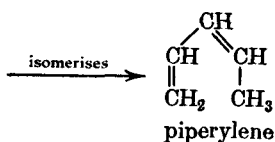
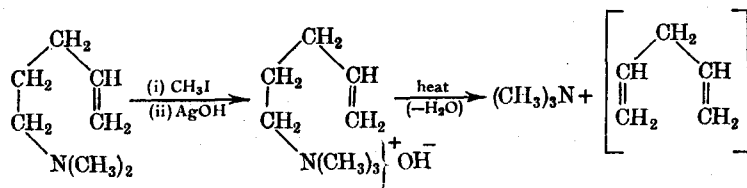
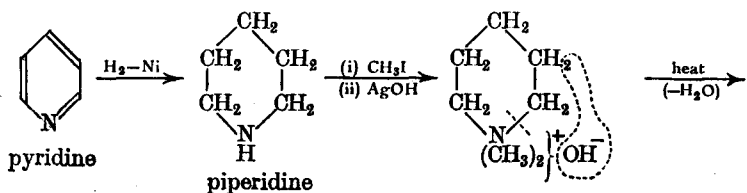

Hofmann's method fails if there is no *β*-hydrogen atom available for elimination as water; in such cases the Emde modification (1909, 1912) may be used. In this method the quaternary ammonium halide is reduced with sodium amalgam in aqueous ethanol or catalytically hydrogenated, *e.g.*,

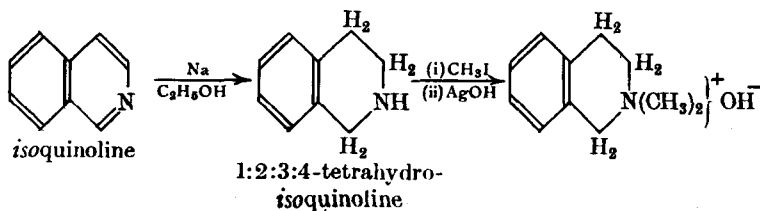



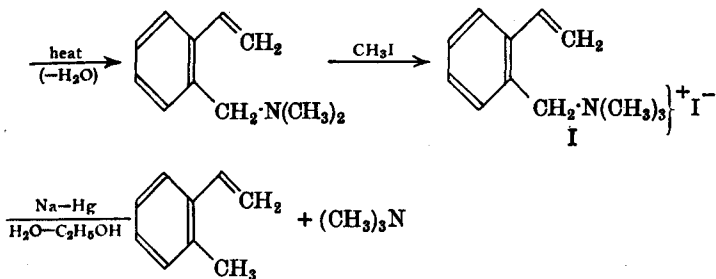

Examination of I shows that  $\beta$ -hydrogen is absent; hence Hofmann's method cannot be used.

Other methods for opening heterocyclic rings containing nitrogen are:

(i) *Von Braun's method* for tertiary cyclic amines (see also Vol. I); e.g.,

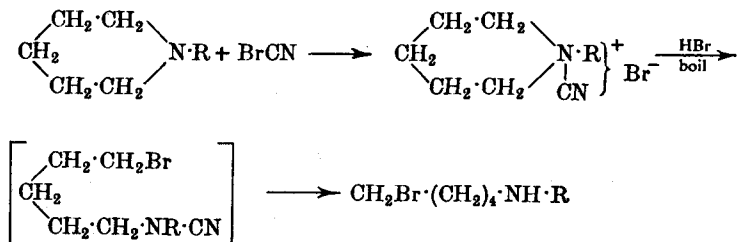

(ii) *Von Braun's method* for secondary cyclic amines (see also Vol. I); e.g.,

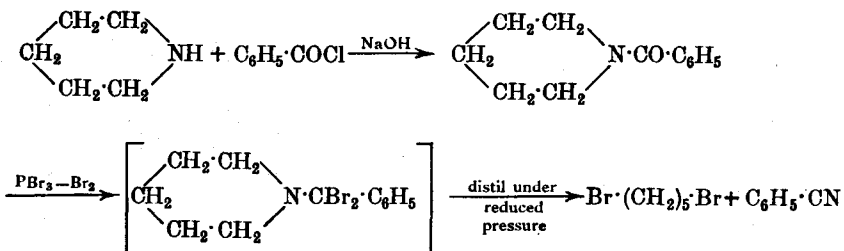

(iii) In a number of cases the ring may be opened by heating with hydriodic acid at  $300^\circ$ , e.g.,

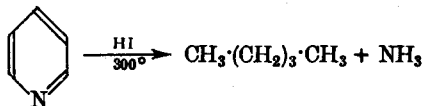

(iv) The presence of unsaturation in an alkaloid may be ascertained by the addition of bromine and halogen acids, or by the ability to be hydroxylated with dilute alkaline permanganate. Reduction by means of sodium amalgam, sodium and ethanol, tin and hydrochloric acid, hydriodic acid, etc., also may be used to show the presence of unsaturation. In some cases, reduction may decompose the molecule. This often happens when catalytic reduction is used (ring cleavage occurs), and hence milder methods of reduction are desirable. Two particularly mild reducing reagents are lithium aluminium hydride and sodium borohydride. Sodium in liquid ammonia gives the Emde type of degradations (see **iii**).

(v) *Oxidation*. This is one of the most valuable means of determining

the structure of alkaloids (*cf.* terpenes, §3. VIII). By varying the "strength" of the oxidising agent, it is possible to obtain a variety of products:

(a) Mild oxidation is usually effected with hydrogen peroxide, ozone, iodine in ethanolic solution, or alkaline potassium ferricyanide.

(b) Moderate oxidation may be carried out by means of acid or alkaline potassium permanganate, or chromium trioxide in acetic acid.

(c) Vigorous oxidation is usually effected by potassium dichromate-sulphuric acid, chromium trioxide-sulphuric acid, concentrated nitric acid, or manganese dioxide-sulphuric acid.

This classification is by no means rigid; the "strength" of an oxidising agent depends to some extent on the nature of the compound being oxidised. In those cases where it can be done, better results are sometimes achieved by first dehydrating the compound and then oxidising the unsaturated compound thus obtained; oxidation is readily effected at a double bond.

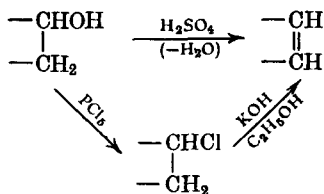

More recently, mercuric acetate has been used to dehydrogenate certain alkaloids, thereby introducing olefinic bonds.

(vi) Fusion of an alkaloid with solid potassium hydroxide often produces relatively simple fragments, the nature of which will give information on the type of nuclei present in the molecule (*cf.* **iiib**).

(vii) *Zinc dust distillation.* This usually gives the same products as (vi), except that when the alkaloid contains oxygen the oxygen is removed.

(viii) Physical methods are also now being used, in conjunction with chemical methods, to elucidate structure, *e.g.*, infra-red spectra studies are used to identify many functional groups; ultraviolet spectra are used to indicate the likely type of structure present; and X-ray analysis has offered a means of distinguishing between alternative structures that appear to fit equally well the alkaloid in question.

(ix) *Synthesis.* The foregoing analytical work will ultimately lead to the proposal of a tentative structure (or structures) for the alkaloid under consideration. The final proof of structure, however, depends on an unambiguous synthesis of the alkaloid.

**§5. Classification of the alkaloids.** Long before the constitutions of the alkaloids were known, the source of the alkaloid was considered the most important characteristic of the compound. Thus there could not be a rational classification. Even today, with the structures of so many known, the classification of the alkaloids is still somewhat arbitrary owing to the difficulty of classifying into distinct groups. Even so, it is probably most satisfactory (chemically) to classify the alkaloids according to the nature of the nucleus present in the molecule. Members of the following groups are described in this book:

- (i) Phenylethylamine group.
- (ii) Pyrrolidine group.
- (iii) Pyridine group.
- (iv) Pyrrolidine-pyridine group.
- (v) Quinoline group.
- (vi) *iso*Quinoline group.
- (vii) Phenanthrene group.

It should be noted that in many cases different alkaloids obtained from the same plant often have similar chemical structures, and so sometimes the source of the alkaloids may indicate chemical similarity.

### PHENYLETHYLAMINE GROUP

Many compounds of this group are known, some natural and others synthetic. Their outstanding physiological action is to increase the blood-pressure; hence they are often referred to as the *pressor drugs*.

§6. **β-Phenylethylamine.** This is the parent substance of this group of alkaloids, and occurs in putrid meat (it is formed by the decarboxylation of phenylalanine, an amino-acid). β-Phenylethylamine may be readily synthesised as follows:

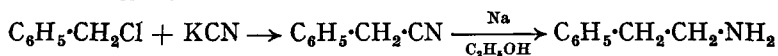

β-Phenylethylamine is a colourless liquid, b.p. 197°.

§7. (–)-**Ephedrine**, m.p. 38.1°. (–)-Ephedrine occurs in the genus *Ephedra*; it is one of the most important drugs in *Ma Huang* (a Chinese drug). Physiologically, its action is similar to that of adrenaline (§12), and it can be taken orally.

The molecular formula of ephedrine is  $\text{C}_{10}\text{H}_{15}\text{ON}$ , and since on oxidation ephedrine forms benzoic acid, the structure therefore contains a benzene ring with only one side-chain. When treated with nitrous acid, ephedrine forms a nitroso-compound; therefore the compound is a secondary amine. Since ephedrine forms a dibenzoyl derivative, one hydroxyl group must be present (one benzoyl group is accounted for by the imino group). Finally, when heated with hydrochloric acid, ephedrine forms methylamine and propiophenone.



The formation of these products can be explained if the structure of ephedrine is either I or II.



I

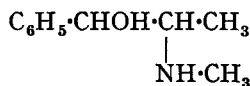

II

It has been observed, however, that compounds of structure II undergo the *hydramine fission* to form propiophenone when heated with hydrochloric acid. Thus II is more likely than I. This is supported by the fact that when subjected to the Hofmann exhaustive methylation method, ephedrine forms *sym.*-methylphenylethylene oxide, III; this cannot be produced from I, but is to be expected from II.

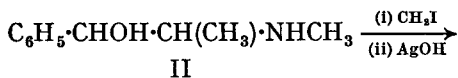

II

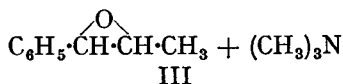
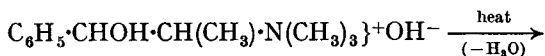

III

Further support for II is afforded by the following evidence. Structure I contains one asymmetric carbon atom, and so replacement of the hydroxyl

group by hydrogen will result in the formation of an optically inactive compound. Structure II, however, contains two asymmetric carbon atoms, and so the replacement of the hydroxyl group by hydrogen should still give a compound that can be optically active. Experimentally it has been found that when this replacement is effected in (-)-ephedrine, the product, deoxyephedrine, is optically active. Thus II agrees with all the known facts, and this structure has been confirmed by synthesis, *e.g.*, Späth *et al.* (1920):

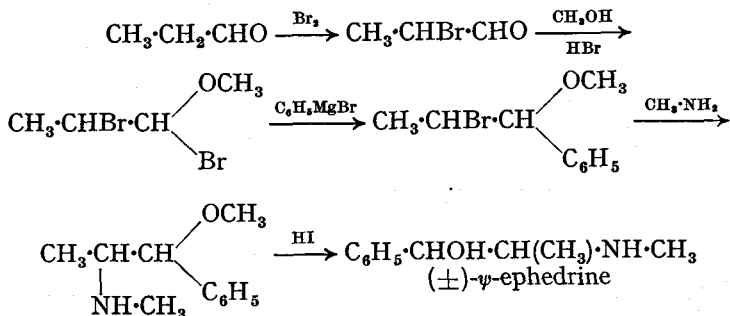

The racemic modification of  $\psi$ -ephedrine (see below) was resolved by means of tartaric acid.

(-)-Ephedrine itself has been synthesised by Manske *et al.* (1929) by the catalytic reduction of 1-phenylpropane-1:2-dione (benzoylacetyl) in the presence of methylamine in methanol solution.

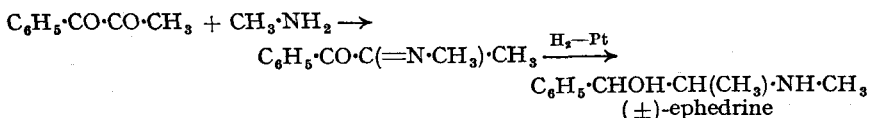

The racemic ephedrine was resolved by means of mandelic acid. Some ( $\pm$ )- $\psi$ -ephedrine was also obtained in this synthesis.

Since the ephedrine molecule contains two dissimilar asymmetric carbon atoms, four optically active forms (two pairs of enantiomorphs) are theoretically possible. According to Freudenberg (1932), the configurations of ephedrine and  $\psi$ -ephedrine are:

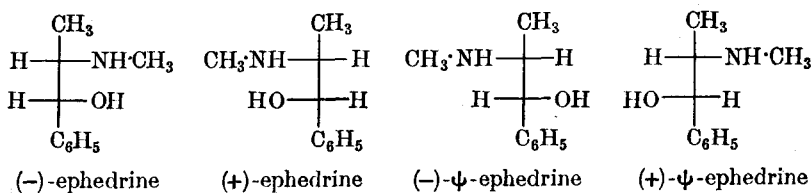

Various mechanisms have been proposed for the hydramine fission. Chatterjee *et al.* (1961) have suggested two different mechanisms according to whether the aryl nucleus contains (i) an electron-releasing group in the *o* and/or *p*-position, *e.g.*, R = OMe, OH, Me:

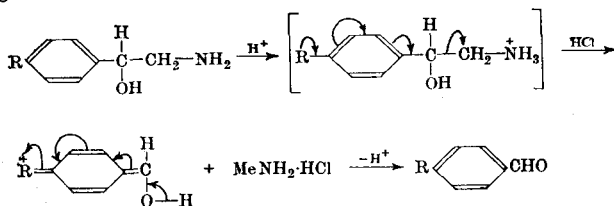

(ii) R in the *m*-position:

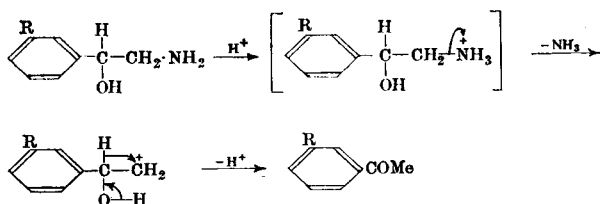

Thus hydramine fission gives an aldehyde or a ketone according to the nature and position of groups in the aryl nucleus. With a 4-nitro group the product is 4-nitroacetophenone (yield: very poor).

§8. **Benzedrine** (*Amphetamine*) was originally introduced as a substitute for ephedrine, but it is now used in its own right since it apparently produces a feeling of confidence.

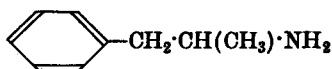

Benzedrine has been synthesised in many ways, *e.g.*, Mingoia (1940):

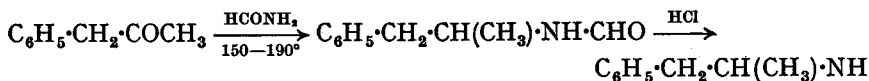

§9.  **$\beta$ -*p*-Hydroxyphenylethylamine** (*tyramine*), m.p. 160°, occurs in ergot, and is produced by the putrefaction of proteins (by the decarboxylation of tyrosine). Tyramine has been synthesised in various ways, *e.g.*,

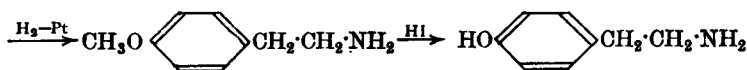
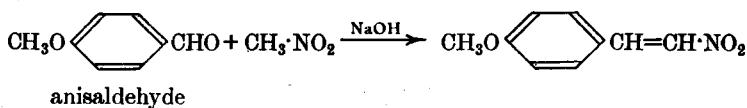

§10. **Hordenine** ( $\beta$ -*p*-hydroxyphenylethyldimethylamine, *Anhaline*), m.p. 117–118°, occurs naturally in germinating barley. The molecular formula of hordenine is  $\text{C}_{10}\text{H}_{15}\text{ON}$ ; the routine tests show that hordenine is a tertiary base and that it contains a phenolic group. Since the methylation of hordenine, followed by oxidation (with alkaline permanganate), gives anisic acid, I, it therefore follows that the hydroxyl group is in the *para*-position with respect to the side-chain. Furthermore, since the methylated compound gives *p*-vinylanisole, II, after the Hofmann exhaustive methylation, the structure of hordenine is probably III.

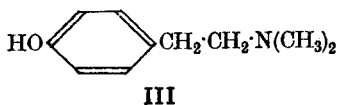
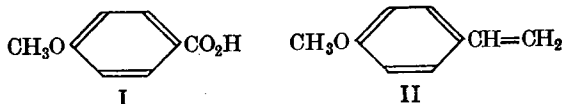

This has been confirmed by synthesis, *e.g.*, Barger (1909):

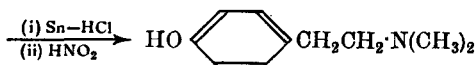
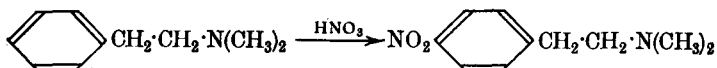
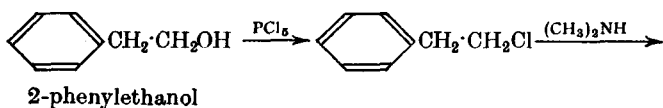

§11. **Mezcaline** (mescaline),  $\text{C}_{11}\text{H}_{17}\text{O}_3\text{N}$ , b.p.  $180\text{--}180.5^\circ/12\text{ mm.}$ , occurs naturally in "mezcal buttons". The routine tests show that mezcaline contains a primary aliphatic amino-group and three methoxyl groups. On oxidation with alkaline permanganate, mezcaline gives 3 : 4 : 5-trimethoxybenzoic acid, and thus the probable structure of mezcaline is I.

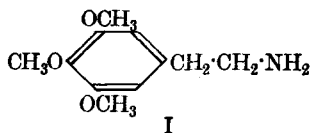

This has been confirmed by synthesis (Späth, 1919):

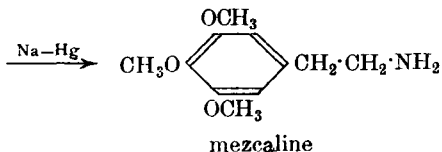
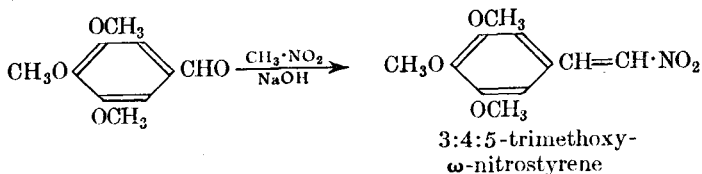
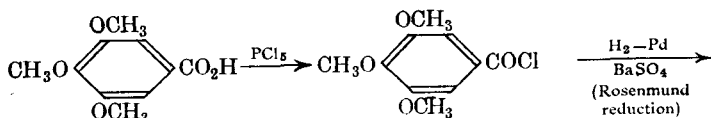

A more recent synthesis of mezcaline is that of Banholzer *et al.* (1952); this makes use of the Arndt-Eistert synthesis.

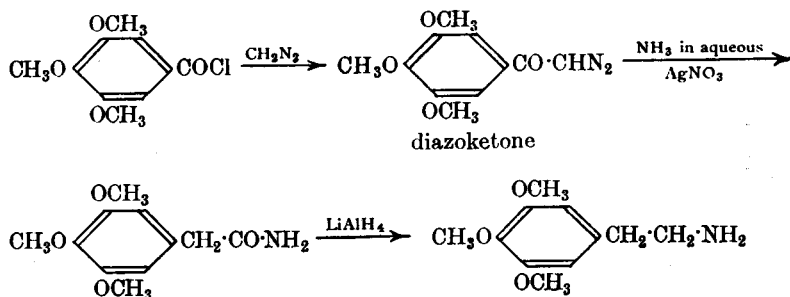

*N*-Methylmezcaline and *N*-acetylmezcaline also occur naturally in mezcal buttons.

§12. **Adrenaline** (*Epinephrine*),  $\text{C}_9\text{H}_{13}\text{O}_3\text{N}$ , is a non-steroid hormone. The adrenal medulla is the source of the hormones adrenaline and nor-adrenaline. Adrenaline was the first hormone to be isolated in a crystalline form (Takamine, 1901; Aldrich, 1901). Adrenaline is active only when given by injection; it raises the blood-pressure, and is used locally to stop hæmorrhage.

Adrenaline is a colourless crystalline solid, m.p.  $211^\circ$ , and dissolves in acids and alkalis (it is insoluble in water); it is also optically active, having a lævorotation.

The phenolic character of adrenaline is indicated by its solubility in sodium hydroxide and its reprecipitation by carbon dioxide. Since it gives a green colour with ferric chloride, this led to the suggestion that adrenaline is a catechol derivative. When boiled with aqueous potassium hydroxide, adrenaline evolves methylamine; thus a methylamino group is probably present. On the other hand, when fused with potassium hydroxide, the product is protocatechuic acid, I (Takamine, 1901); methylation, followed

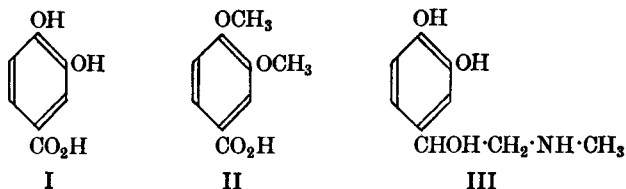

by fusion with potassium hydroxide, gives veratric acid, II, and trimethylamine (Jowett, 1904). The formation of trimethylamine indicates that the nitrogen atom must occur at the *end* of the side-chain. Since adrenaline is optically active, it must contain at least one asymmetric carbon atom. Now adrenaline contains three hydroxyl groups, two of which are phenolic (as shown by the formation of I and II). The third hydroxyl group was shown to be secondary alcoholic by the fact that when adrenaline is treated with benzenesulphonyl chloride, a tribenzenesulphonyl derivative is obtained which, on oxidation, gives a ketone (Friedmann, 1906). To account for the oxidation of adrenaline to the benzoic acid derivative, the  $-\text{CHOH}-$  group must be attached directly to the nucleus; had it been  $-\text{CH}_2\text{CHOH}-$ , then a phenylacetic acid derivative would have been obtained. All the foregoing facts are in keeping with structure III for adrenaline, and this has been confirmed by synthesis by Stolz (1904) and Dakin (1905), with improvements by Ott (1926).

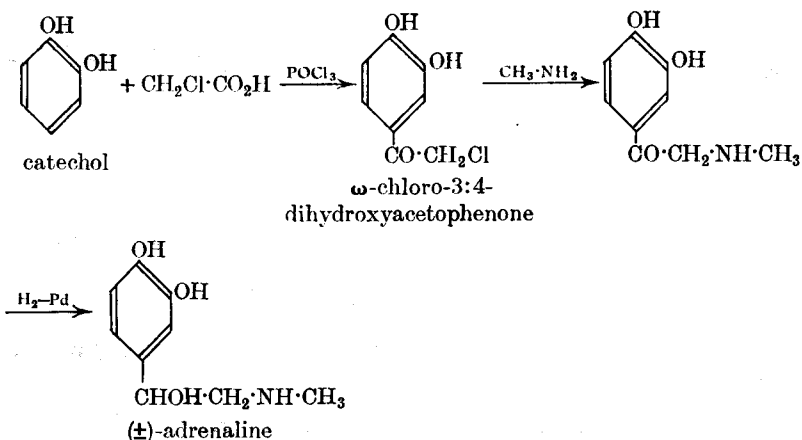

The racemic adrenaline has been resolved by means of (+)-tartaric acid. Nagai (1918) has also synthesised adrenaline as follows:

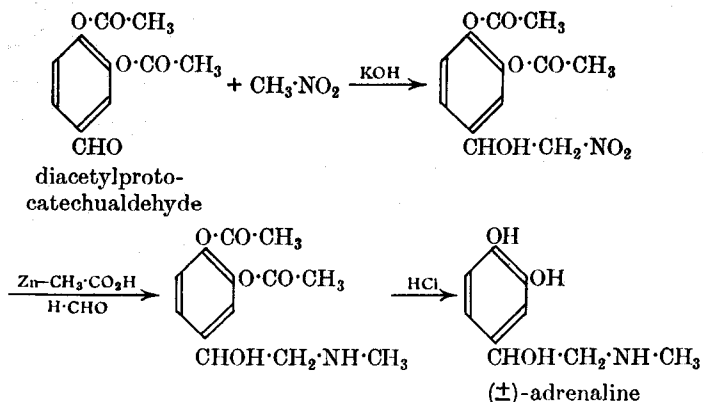

According to Dalglish (1953), the configuration of (–)-adrenaline is probably

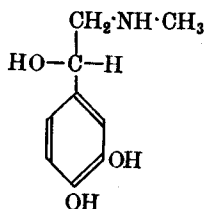

§12a. **Noradrenaline (Norepinephrine)**,  $\text{C}_8\text{H}_{11}\text{O}_3\text{N}$ , is also present in the adrenal medulla. The natural compound is laevorotatory, and this (–)-isomer is the most powerful pressor-compound known. The structure of noradrenaline has been established by analytical work similar to that described for adrenaline, and has been confirmed by various syntheses, e.g.,



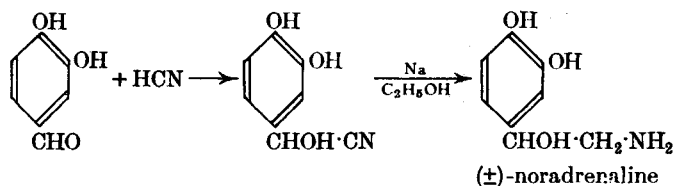

According to Dalglish (1953), the configuration of (–)-noradrenaline is

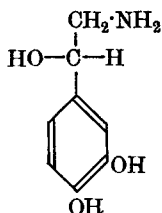

### PYRROLIDINE GROUP

§13. **Hygrine**,  $\text{C}_8\text{H}_{15}\text{ON}$ , b.p. 193–195°, is one of the coca alkaloids. Its reactions show the presence of a keto group and a tertiary nitrogen atom, and when oxidised with chromic acid, hygrinic acid is formed.

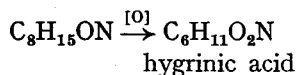

Hygrinic acid was first believed to be a piperidinecarboxylic acid, but comparison with the three piperidine acids showed that this was incorrect. When subjected to dry distillation, hygrinic acid gives *N*-methylpyrrolidine; hence hygrinic acid is an *N*-methylpyrrolidinecarboxylic acid. Furthermore, since the decarboxylation occurs very readily, the carboxyl group was assumed to be in the 2-position (by analogy with the  $\alpha$ -amino-acids). This structure, 1-methylpyrrolidine-2-carboxylic acid, for hygrinic acid was confirmed by synthesis (Willstätter, 1900).

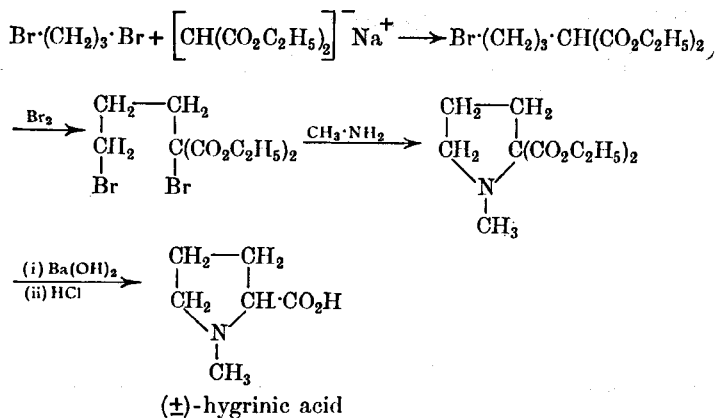

Thus a possible structure for hygrine is

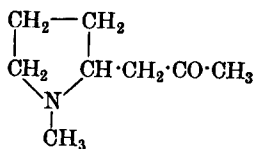

Hess (1913) claimed to have confirmed this structure by synthesis; his synthesis starts with pyrrolmagnesium bromide and propylene oxide to form pyrrolpropanol (note the rearrangement that occurs). This compound is then catalytically hydrogenated and then treated with formaldehyde; the imino nitrogen is methylated and the secondary alcoholic is oxidised to a keto group.

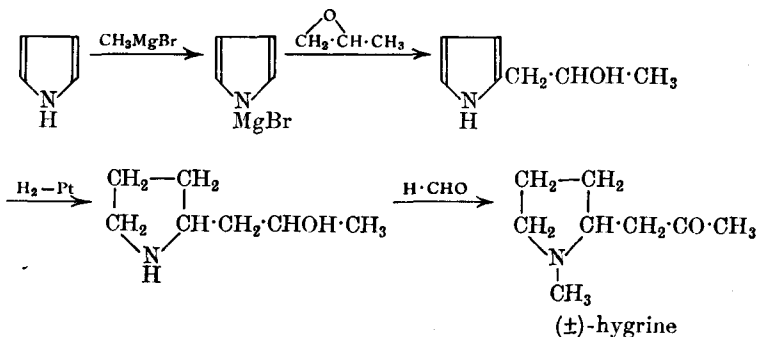

Lukeš *et al.* (1959) have repeated Hess's work and have shown that the

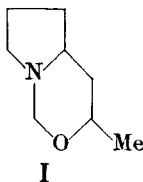

product is not hygrine but the tetrahydro-oxazine (I); it is the last stage of Hess's interpretation that has been shown to be incorrect.

Anet *et al.* (1949) have also synthesised ( $\pm$ )-hygrine by condensing  $\gamma$ -methylaminobutyraldehyde with ethyl acetoacetate in a buffered solution at a pH of 7 (physiological conditions).

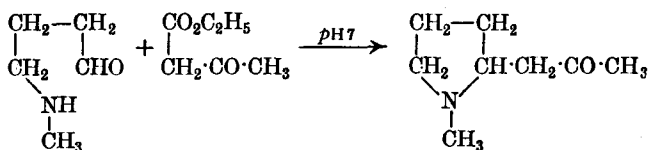

§13a. **Cuscohygrine** (*Cuskygrine*), b.p. 169–170°/23 mm., occurs with hygrine. Its structure is established by the following synthesis (Anet *et al.*, 1949);  $\gamma$ -methylaminobutyraldehyde is condensed with acetonedicarboxylic ester:

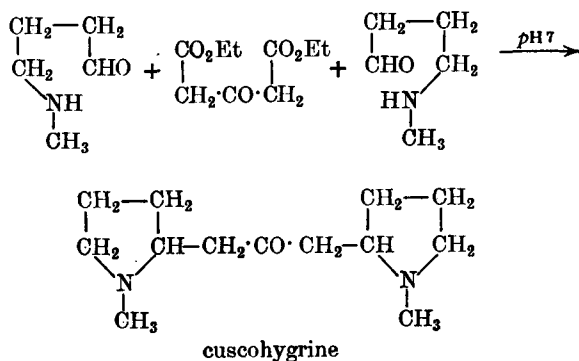

§13b. **Stachydrine** is obtained from the roots of *Stachys tubertifa*, from orange leaves, etc. It is the betaine (§4 C. XIII) of the quaternary ammonium compound of hygrinic acid.

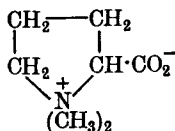

§14. **Gramine** has been found in barley mutants; it raises the blood-pressure in dogs when administered in small doses. Gramine has been synthesised by allowing indole to stand in an aqueous solution containing formaldehyde and dimethylamine (Snyder *et al.*, 1944).

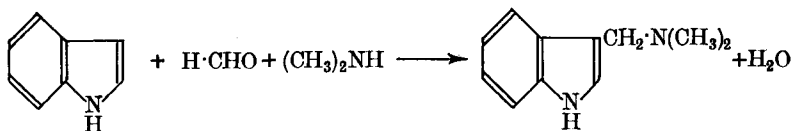

#### PYRIDINE GROUP

§15. **Trigonelline**,  $\text{C}_7\text{H}_7\text{O}_2\text{N}$ , m.p.  $130^\circ$ , is widely distributed in plants; the best source is the coffee bean. When boiled with barium hydroxide solution trigonelline produces methylamine; thus the molecule contains an *N*-methylamino group. On the other hand, when heated with hydrochloric acid at  $250^\circ$  under pressure, trigonelline forms methyl chloride and nicotinic acid; this suggests that the alkaloid is the methyl betaine of nicotinic acid. This structure for trigonelline has been confirmed by synthesis (Hantzsch, 1886). When heated with methyl iodide in the presence of potassium hydroxide, nicotinic acid, I, is converted into methyl nicotinate methiodide, II. II, on treatment with "silver hydroxide" solution, forms nicotinic acid methohydroxide, III, which then spontaneously loses a molecule of water to give trigonelline (a betaine), IV.

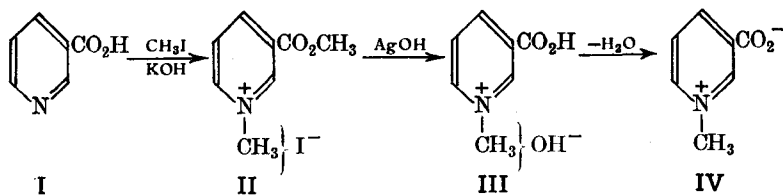

§16. **Ricine**,  $C_8H_8O_2N_2$ , m.p.  $201.5^\circ$ , has been isolated from castor-oil seed; it is not a very toxic alkaloid. Degradative and synthetic work led to the suggestion that I is the structure of ricinine.

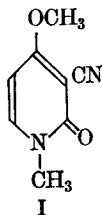

This has been confirmed by synthesis, *e.g.*, Späth *et al.* (1923);

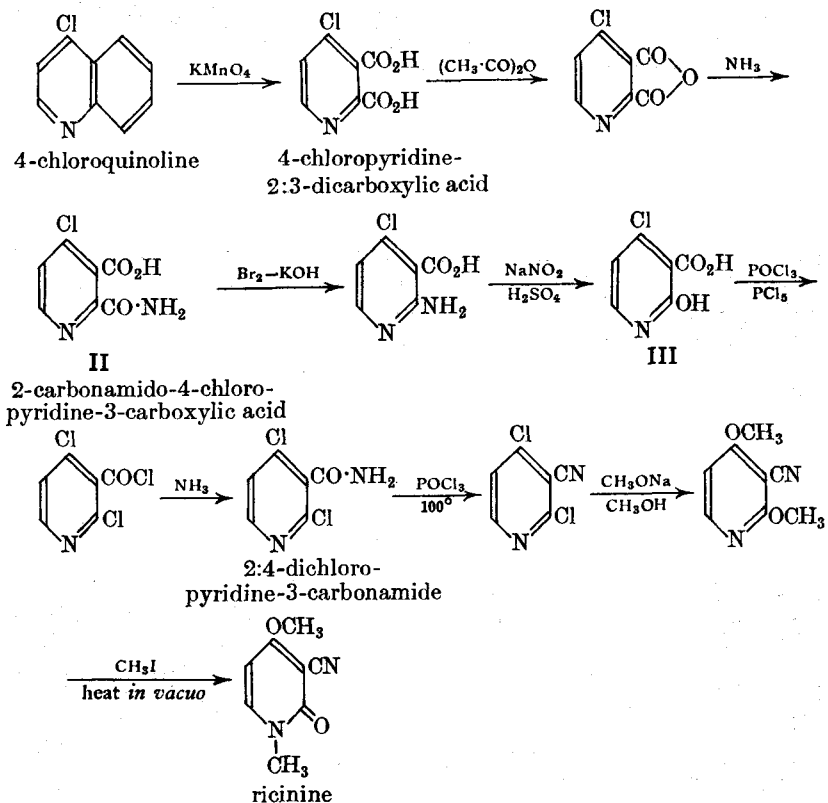

This is not an unambiguous synthesis, since II could have been 3-carbonamido-4-chloropyridine-2-carboxylic acid, II*a*, and consequently III would have been III*a*.

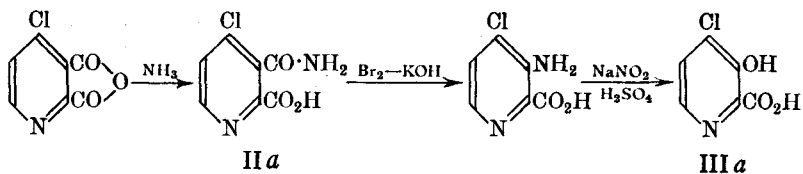

The structure of III was proved by the fact that on hydrogenation in the presence of Pd—BaSO<sub>4</sub>, it gave 2-hydroxypyridine-3-carboxylic acid, IV.

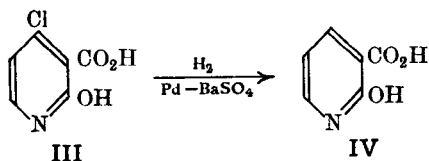

A more recent synthesis of ricinine is that of Taylor *et al.* (1956).

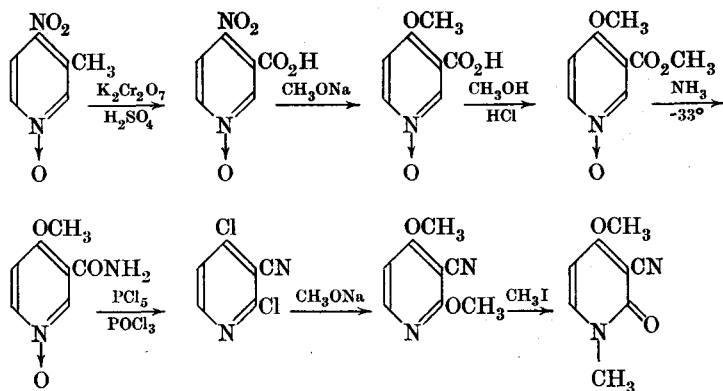

**§17. Areca (or Betel) nut alkaloids.** The betel nut is the source of a number of alkaloids which are all partially hydrogenated derivatives of nicotinic acid, *e.g.*,

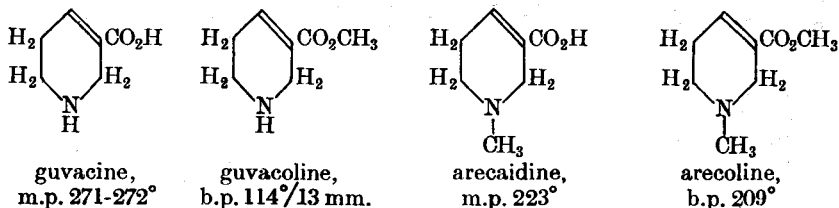

Let us consider arecaidine; its molecular formula is C<sub>7</sub>H<sub>11</sub>O<sub>2</sub>N. When distilled with zinc dust, guvacine gives 3-methylpyridine; therefore this alkaloid is a pyridine derivative. Now guvacine is converted into arecaidine on heating with potassium methyl sulphate and sodium methoxide (Jahns, 1888, 1890); thus arecaidine is a methyl derivative of guvacine, and consequently is also a pyridine derivative. The usual tests show that arecaidine contains one carboxyl group, an *N*-methyl group and one double bond; hence the formula for arecaidine may be written as C<sub>6</sub>H<sub>7</sub>N(CH<sub>3</sub>)·CO<sub>2</sub>H. Since the alkaloid is a pyridine derivative, the fragment C<sub>5</sub>H<sub>7</sub>N could be tetrahydropyridine. This was proved to be so by synthesis, and at the same time the positions of the double bond and carboxyl group were also established (Wohl *et al.*, 1907). Acraldehyde, I, on treatment with ethanol in the presence of hydrogen chloride, forms 3-chloropropionaldehyde acetal, II. II reacts with methylamine to form β-methyliminodipropionaldehyde tetra-acetal, III, which, on treatment with concentrated hydrochloric acid, ring closes to form 1 : 2 : 5 : 6-tetrahydro-1-methylpyridine-3-aldehyde, IV. This gives the cyano compound V on treatment with hydroxylamine, followed by dehydration of the oxime with thionyl chloride, and V is then converted into

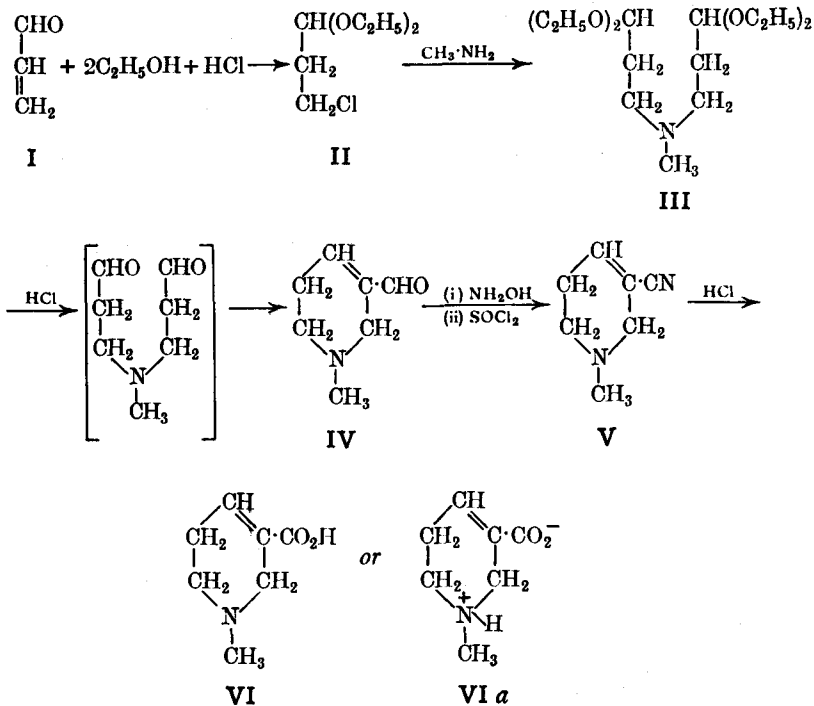

arecaidine by hydrolysis. Arecaidine is VI, or possibly VIa, the dipolar ion structure (*cf.* amino-acids and betaines).

A more recent synthesis of arecaidine (and guvaccine) is that of McElvain *et al.* (1946).

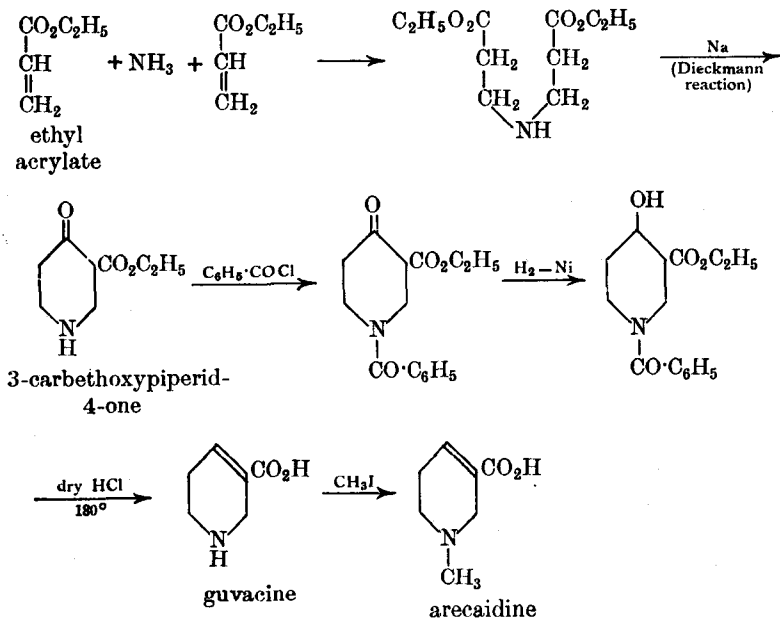

§18. **Hemlock alkaloids.** The most important alkaloid of this group is **coniine**; it was the first alkaloid to be synthesised. Oil of hemlock was drunk by Socrates when he was condemned to death in 399 B.C.

(+)-**Coniine**,  $C_8H_{17}N$ , b.p. 166–167°, is the form that occurs in oil of hemlock. When distilled with zinc dust, coniine is converted into conyryne,  $C_8H_{11}N$  (Hofmann, 1884). Since the oxidation of conyryne with permanganate gives pyridine-2-carboxylic acid ( $\alpha$ -picolinic acid), it follows that a pyridine nucleus is present with a side-chain in the 2-position. Thus coniine is probably a piperidine derivative with a side-chain in the 2-position. This side-chain must contain three carbon atoms, since two are lost when conyryne is oxidised. This side-chain is therefore either *n*-propyl or *isopropyl*, and it was actually shown to be *n*-propyl by the fact that when heated with

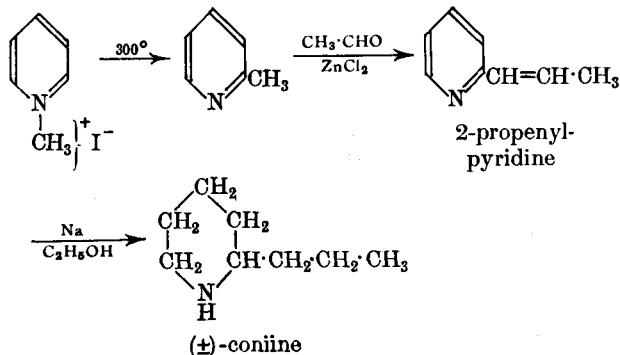

hydriodic acid at 300° under pressure, coniine forms *n*-octane. Had the side-chain been *isopropyl*, then the expected product would be *iso*-octane. From this evidence it therefore follows that coniine is 2-*n*-propylpiperidine, and this has been confirmed by synthesis (Ladenburg, 1885). The racemic coniine was resolved by means of (+)-tartaric acid, and the (+)-coniine so obtained was found to be identical with the natural compound.

The reactions of coniine described above can therefore be formulated as follows:

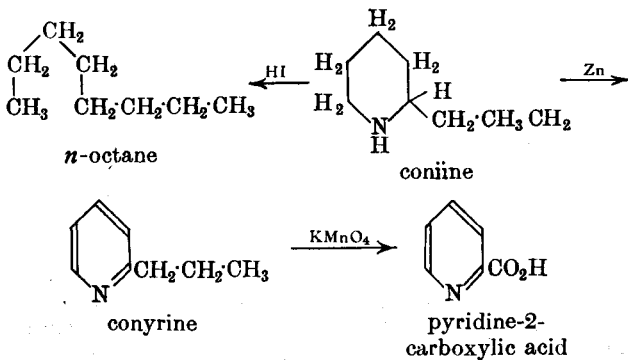

Coniine has also been synthesised from 2-methylpyridine and phenyllithium as follows (Bergmann *et al.*, 1932):

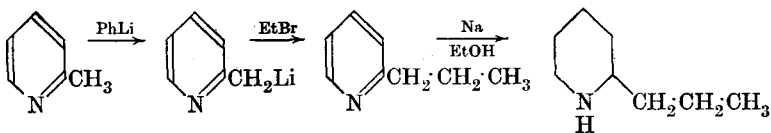

Other hemlock alkaloids are:

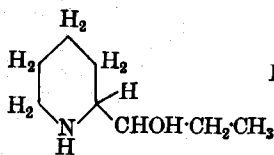

conhydrine

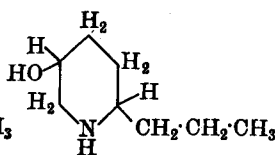

ψ-conhydrine

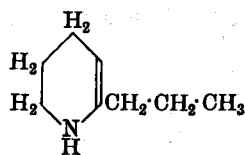

γ-coniceine

§19. **Pomegranate alkaloids.** The root bark of the pomegranate tree contains a number of alkaloids, the most important of which is pelletierine; three others are isopelletierine, methylisopelletierine and pseudo-pelletierine. The last of these is related to atropine (§22).

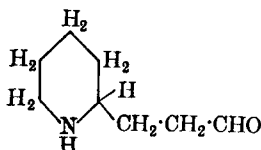

pelletierine

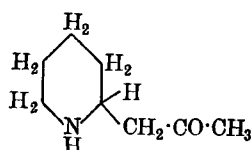

isopelletierine

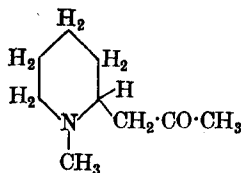

methylisopelletierine

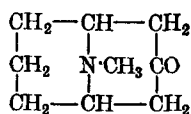

pseudo-pelletierine

Pelletierine acetal has been synthesised by Spielman *et al.* (1941) by the action of 3-bromopropionaldehyde acetal on 2-methylpyridine ( $\alpha$ -picoline) in the presence of phenyl-lithium, followed by catalytic reduction.

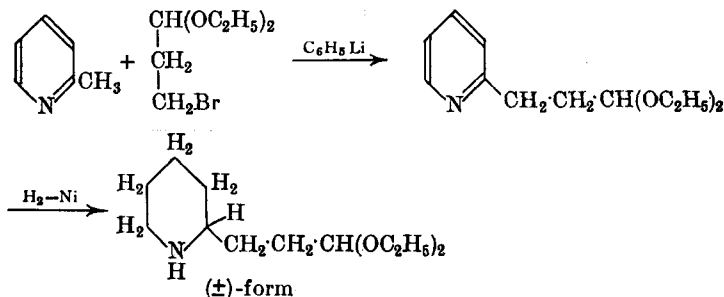

Pelletierine acetal was also prepared by Wibaut *et al.* (1940) who attempted to hydrolyse it to the free aldehyde; they obtained only viscous oils. Spielman *et al.* also failed to obtain the free aldehyde. Beets (1943) has therefore suggested that pelletierine can, and probably does, exist as some bicyclic structure such as I.

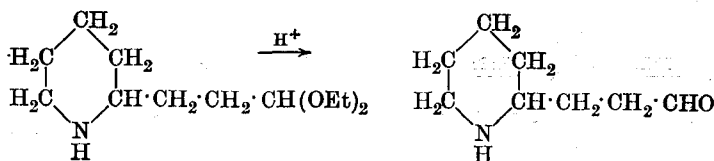



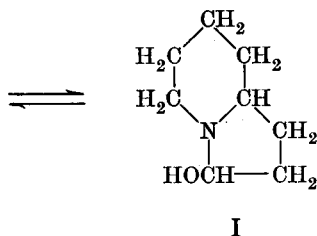

§20. **Piperine**,  $\text{C}_{17}\text{H}_{19}\text{O}_3\text{N}$ , m.p. 128–129.5°, occurs in pepper, especially black pepper (*Piper nigrum*). Hydrolysis of piperine with alkali gives

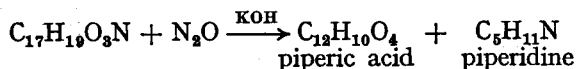

piperic acid and piperidine; thus the alkaloid is the piperidine amide of piperic acid (Babo *et al.*, 1857). Since piperidine is hexahydropyridine, the structure of piperine rests on the elucidation of that of piperic acid. The routine tests show that piperic acid contains one carboxyl group and two double bonds. When oxidised with permanganate, piperic acid gives first piperonal and then piperonylic acid. The structure of the latter is deduced from the fact that when heated with hydrochloric acid at 200° under pressure, piperonylic acid forms protocatechuic acid (3:4-dihydroxybenzoic acid) and formaldehyde.

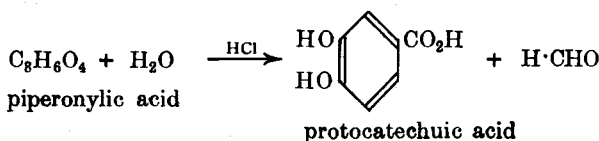

Since one atom of carbon is eliminated, and there are no free hydroxyl groups in piperonylic acid, the structure of this acid is probably the methylene ether of protocatechuic acid, *i.e.*, piperonylic acid is 3:4-methylenedioxybenzoic acid; this has been confirmed by synthesis:

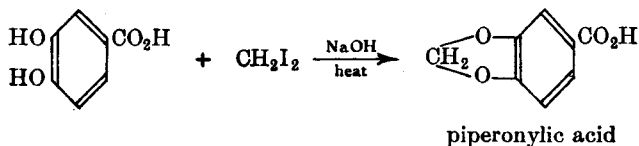

Furthermore, since piperonal (an aldehyde) gives piperonylic acid on oxidation, piperonal is therefore 3:4-methylenedioxybenzaldehyde.

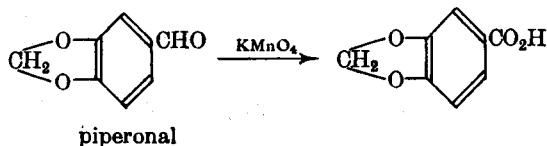

From these results of oxidative degradation, it therefore follows that piperic acid is a benzene derivative containing only one side-chain. It is this side-chain that contains the two double bonds (the ready addition of four bromine atoms shows the presence of two *ethylenic* bonds), and since the careful oxidation of piperic acid gives tartaric acid in addition to piperonal and piperonylic acid, the side-chain is a "straight" chain. If we assume I as

the structure of piperic acid, then all of the foregoing products of oxidation may be accounted for.

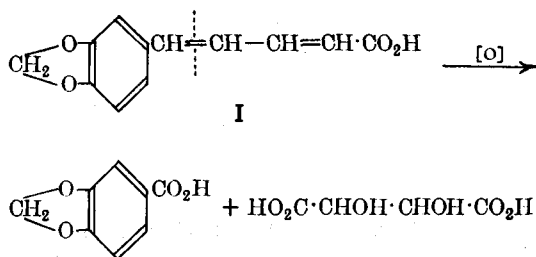

This has been confirmed by synthesis (Ladenburg *et al.*, 1894); piperonal (prepared *via* the Reimer-Tiemann reaction) is condensed with acetaldehyde in the presence of sodium hydroxide (Claisen-Schmidt reaction), and the product (a cinnamaldehyde derivative) is then heated with acetic anhydride in the presence of sodium acetate (Perkin reaction).

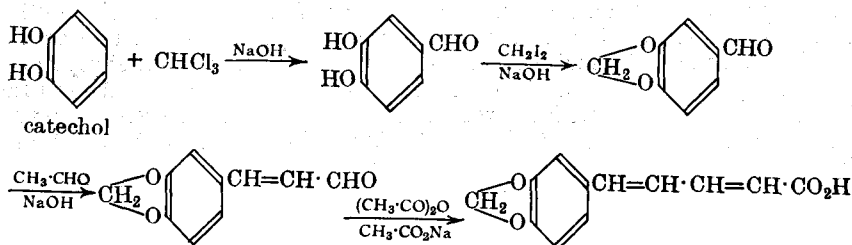

When the acid chloride of piperic acid (prepared by the action of phosphorus pentachloride on the acid) is heated with piperidine in benzene solution, piperine is formed; thus piperine is the piperidine amide of piperic acid.

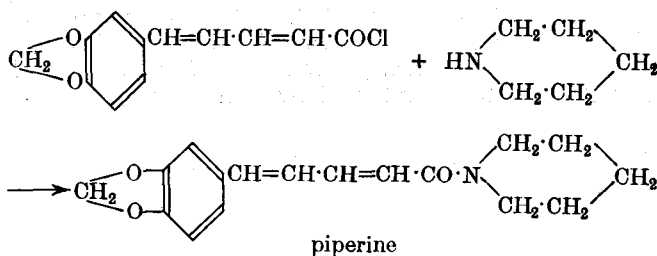

### PYRROLIDINE-PYRIDINE GROUP

§21. **Tobacco alkaloids.** Many alkaloids have been isolated from the tobacco leaf, *e.g.*, nicotine, nicotimine (anabasine), nornicotine, etc.

**Nicotine**,  $\text{C}_{10}\text{H}_{14}\text{N}_2$ , b.p.  $247^\circ$ , is the best known and most widely distributed of the tobacco alkaloids; it occurs naturally as the (-)-form. When oxidised with dichromate-sulphuric acid (or permanganate or nitric acid), nicotine forms nicotinic acid (Huber, 1867).

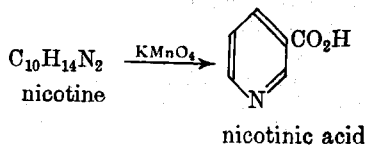

It is instructive, at this point, to see how the orientations of the three isomeric pyridinecarboxylic acids have been elucidated.

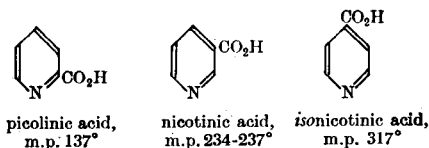

*Picolinic acid.* 1-Naphthylamine, I, when subjected to the Skraup synthesis (see Vol. I), is converted into 7:8-benzoquinoline, II (this structure is established by its synthesis). II, on vigorous oxidation with alkaline permanganate, gives the dicarboxylic acid III which, when decarboxylated by heating with calcium oxide, is converted into 2-phenylpyridine, IV. This, on further oxidation with permanganate, gives a pyridinecarboxylic acid which must, from the structure of IV, be the 2-acid, *i.e.*, picolinic acid, V.

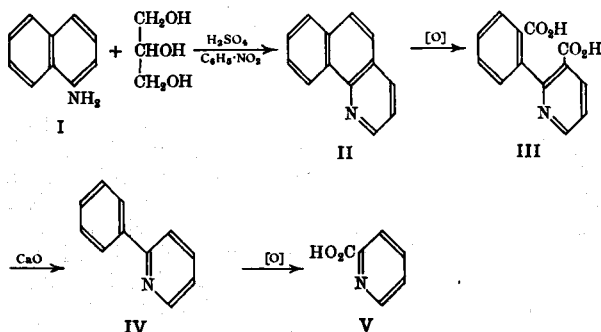

*Nicotinic acid.* This has been shown to be pyridine-3-carboxylic acid by a similar set of reactions, except that in this case the starting material is 2-naphthylamine.

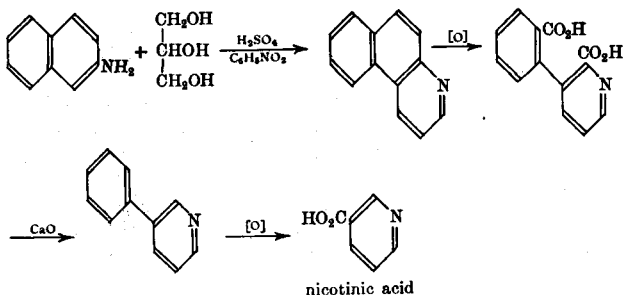

*isoNicotinic acid.* This third isomer is therefore pyridine-4-carboxylic acid.

An alternative proof for the orientations of these three acids is based on the structures of quinoline and *isoquinoline* (which have been established by synthesis). Oxidation of quinoline with alkaline permanganate gives quinolinic acid which, by its method of preparation, must be pyridine-2:3-dicarboxylic acid. When quinolinic acid is heated to 190°, one carboxyl group is lost to produce nicotinic acid; thus nicotinic acid must be either pyridine-2- or -3-carboxylic acid. *isoQuinoline*, on oxidation with alkaline permanganate, produces cinchomeronic acid, which must therefore be pyridine-3:4-dicarboxylic acid. This, on gentle heating, gives a mixture of nicotinic and *isonicotinic* acids; thus nicotinic acid must be the 3-acid, and *isonicotinic* acid the 4-acid. Hence picolinic acid is pyridine-2-carboxylic acid.

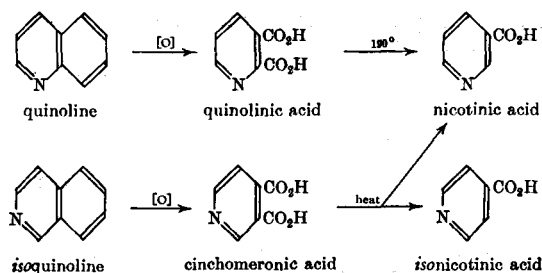

Returning to the structure of nicotine, since nicotinic acid is a product of oxidation, the alkaloid therefore contains a pyridine nucleus with a complex side-chain in the 3-position. Thus we may write the formula of nicotine as

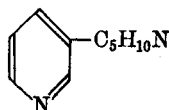

Because of its formula, this side-chain was originally believed to be piperidine, but further work showed that this was incorrect. When nicotine zincchloride is distilled, the products are pyridine, pyrrole and methylamine (Laiblin, 1879). This suggests that the side-chain C<sub>5</sub>H<sub>10</sub>N is a pyrrole derivative. Furthermore, when nicotine is heated with concentrated hydriodic acid at 150° (Herzig-Meyer method), methyl iodide is formed. Thus the side-chain contains an *N*-methyl group. It therefore appears that the side-chain could be *N*-methylpyrrolidine, but its point of attachment to the pyridine nucleus could be either 2 or 3 on the evidence obtained so far:

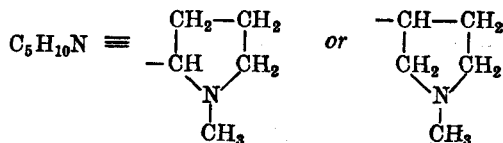

The correct structure of nicotine was obtained by Pinner (1892, 1893). Treatment of nicotine with bromine in acetic acid gives, among other products, the hydrobromide perbromide, C<sub>10</sub>H<sub>10</sub>ON<sub>2</sub>Br<sub>2</sub>·HBr·Br<sub>2</sub>, which, when treated with aqueous sulphurous acid, is converted into dibromocotinine, C<sub>10</sub>H<sub>10</sub>ON<sub>2</sub>Br<sub>2</sub>. This, on heating with a mixture of sulphurous and sulphuric acids at 130–140°, forms 3-acetylpyridine, oxalic acid and methylamine. Thus the structure of nicotine must account for the following skeleton structures:

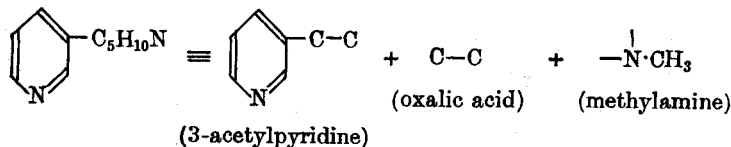

Now bromine, in the presence of hydrobromic acid, converts nicotine into dibromoticonine, C<sub>10</sub>H<sub>8</sub>O<sub>2</sub>N<sub>2</sub>Br<sub>2</sub>, which, on heating with barium hydroxide solution at 100°, forms nicotinic acid, malonic acid and methylamine. Hence the structure of nicotine must also account for the following skeleton structures:

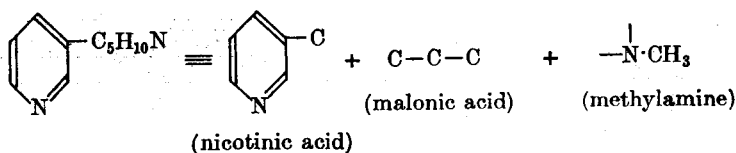

These two sets of reactions, taken in conjunction with one another, are satisfied by the following skeleton for nicotine:

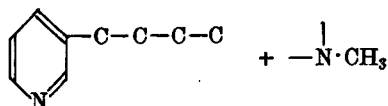

The problem now is: Where is the position of the *N*-methyl group? Nicotine behaves as a *di-tertiary base*, and forms two isomeric "methyl iodide addition products". Thus the nitrogen atom in the side-chain must be of the type  $\text{---C---N(CH}_3\text{)---C---}$ . Furthermore, it is extremely difficult to reduce nicotine beyond hexahydronicotine (the pyridine part is reduced to piperidine). Hence the side-chain must be saturated, and this can only be so if the side-chain is cyclic, *i.e.*, *N*-methylpyrrolidine ( $\text{C}_5\text{H}_{11}\text{N} \equiv \text{C}_4\text{H}_8\cdot\text{NCH}_3 \equiv \text{C}_4\text{H}_8$ ). The presence of this pyrrolidine nucleus also accounts for the formation of pyrrole when nicotine zincchloride is distilled (see above). All the foregoing facts are satisfied by the following structure for nicotine.

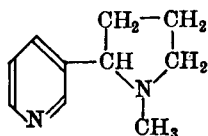

nicotine

On this basis, Pinner's work may be formulated:

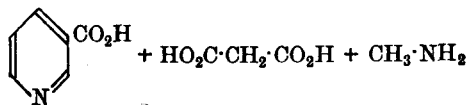
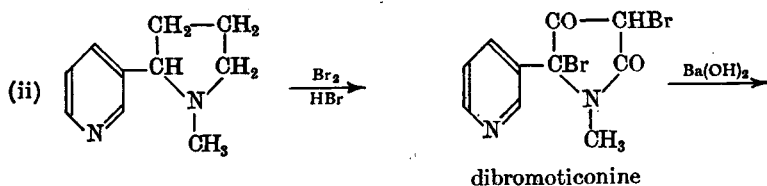
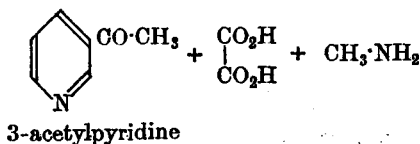
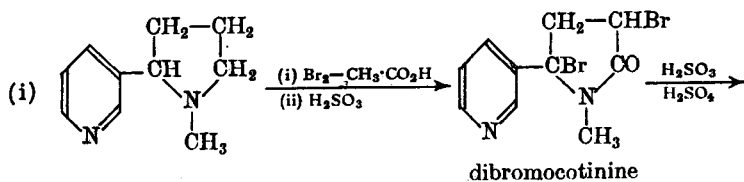

The most direct analytical evidence for the presence of the pyrrolidine nucleus has been given by Karrer (1925, 1926); nicotine hydriodide forms nicotine isomethiodide when warmed with methyl iodide and this, on oxidation with potassium ferricyanide, is converted into nicotone which, on oxidation with chromium trioxide, gives hygrinic acid (§13).

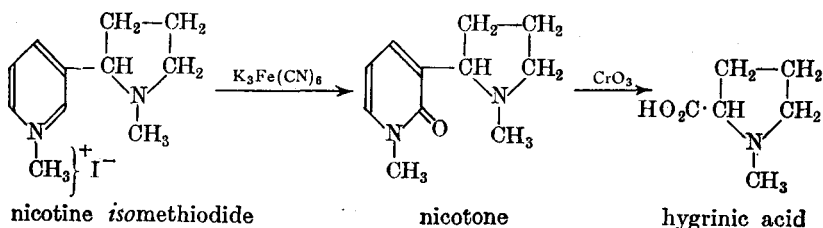

Pinner's formula for nicotine has been confirmed by synthesis, *e.g.*, Späth and Bretschneider (1928).

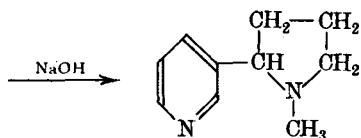
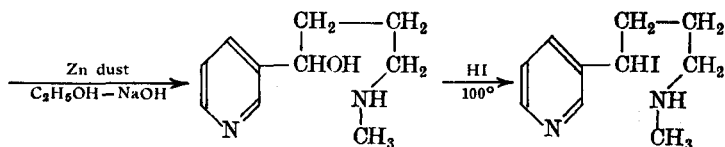
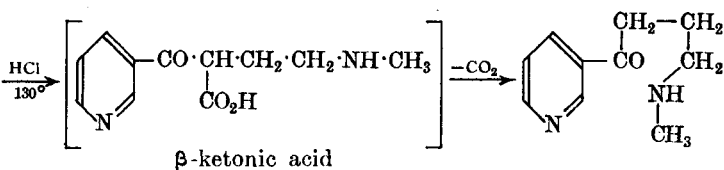
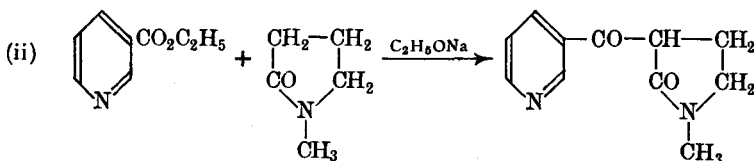
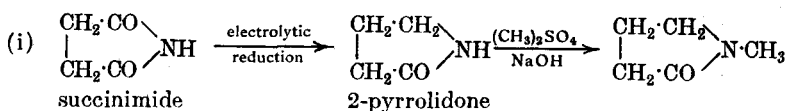

(±)-nicotine

This was resolved by means of (+)-tartaric acid; the synthetic (−)-nicotine is identical with the natural compound.

Craig (1933).

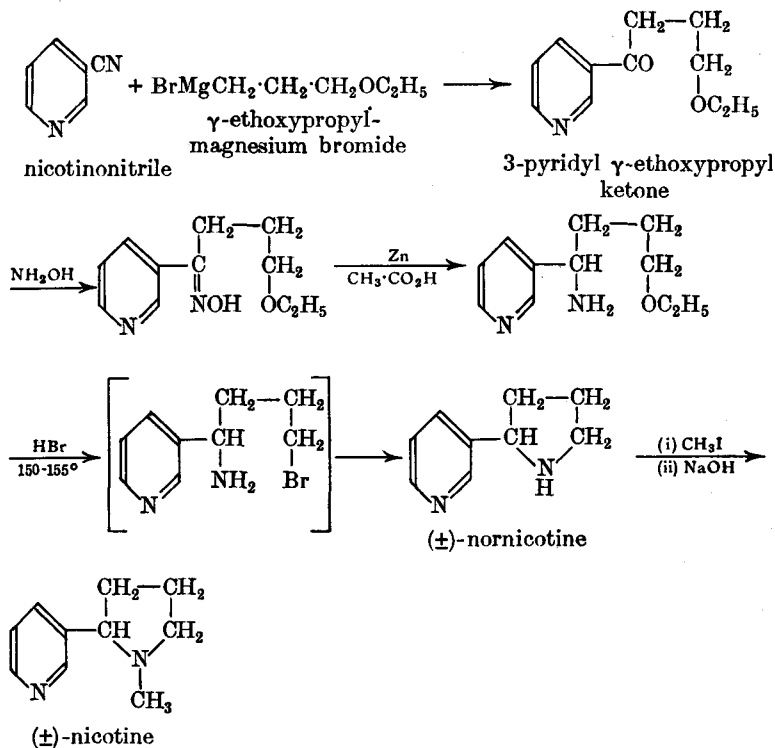

Späth *et al.* (1936) have resolved (±)-normnicotine; methylation of the (–)-form with formaldehyde and formic acid gave (–)-nicotine, identical with the natural product.

**§22. Solanaceous alkaloids.** This group includes atropine, hyoscyamine and scopolamine (hyoscyne).

**Atropine**,  $\text{C}_{17}\text{H}_{23}\text{O}_3\text{N}$ , m.p.  $118^\circ$ , occurs in deadly nightshade (*Atropa belladonna*) together with hyoscyamine. Hyoscyamine is optically active (laevorotatory), but readily racemises to atropine when warmed in an ethanolic alkaline solution; thus atropine is (±)-hyoscyamine.

When warmed with barium hydroxide solution, atropine is hydrolysed to (±)-tropic acid and tropine (an alcohol); thus atropine is the tropine ester of tropic acid.

(±)-Tropic acid,  $\text{C}_9\text{H}_{10}\text{O}_3$ , m.p.  $117^\circ$ , is a saturated compound (it does not add on bromine); the usual tests show that it contains one carboxyl group and one alcoholic group. When heated strongly, tropic acid loses a molecule of water to form atropic acid,  $\text{C}_9\text{H}_8\text{O}_2$ , and this, on oxidation,

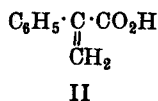
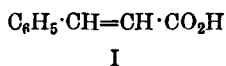

gives benzoic acid. Thus tropic and atropic acids contain a benzene ring with one side-chain. It therefore follows that atropic acid could be either I or II. Since, however, I is known to be cinnamic acid, II must be atropic acid. Addition of a molecule of water to II would therefore give tropic

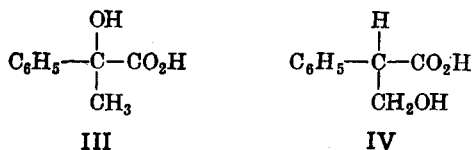

acid which, consequently, must be either III or IV. Tropic acid has been shown to be IV by synthesis, *e.g.*, Mackenzie and Wood (1919), starting from acetophenone.

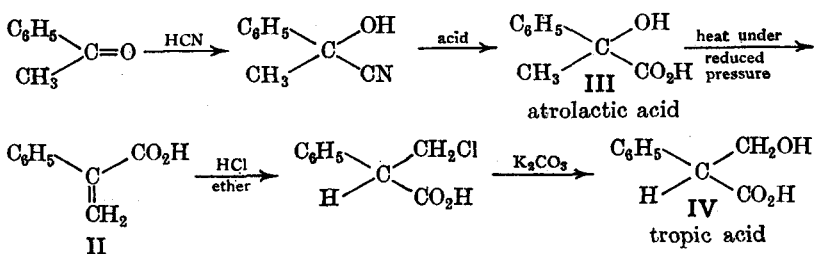

III is atrolactic acid, and its dehydration to II confirms the structure of atropic acid. It should also be noted that the addition of hydrogen chloride takes place contrary to Markownikoff's rule (see unsaturated acids, Vol. I); had the addition been in accordance with the rule, then atrolactic acid would have again been obtained. It is tropic acid that contains the asymmetric carbon atom which gives rise to the optically active hyoscyamine. The above synthesis results in ( $\pm$ )-tropic acid, and this has been resolved by means of quinine.

Blicke *et al.* (1952) have synthesised tropic acid by boiling phenylacetic acid with *isopropylmagnesium chloride* in ethereal solution, and then treating the product, a Grignard reagent, with formaldehyde.

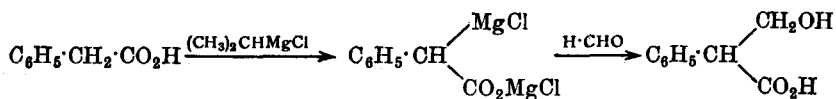

Fodor *et al.* (1961) have established the absolute configuration of (–)-tropic acid by its correlation with (–)-alanine. According to the Cahn-Ingold-Prelog convention (§5c. II), natural tropic acid is (S)-(–)-tropic acid.

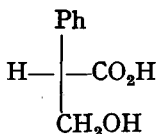

**Tropine** (tropanol),  $\text{C}_8\text{H}_{15}\text{ON}$ , m.p.  $63^\circ$ , behaves as a saturated compound which contains an alcoholic group. The structure of tropine was investigated by Ladenburg (1883, 1887), who showed that the molecule contained a reduced pyridine nucleus:

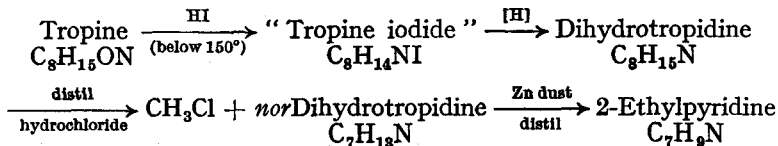



“Tropine iodide” is formed by the replacement of the alcoholic group in tropine by an iodine atom, which is then replaced by hydrogen to form dihydrotropidine (tropane). The formation of methyl chloride indicates the presence of an *N*-methyl group, and the isolation of 2-ethylpyridine shows the presence of this nucleus (in a reduced form). Largely on this evidence, Ladenburg was led to suggest the following alternative formulæ for tropine:

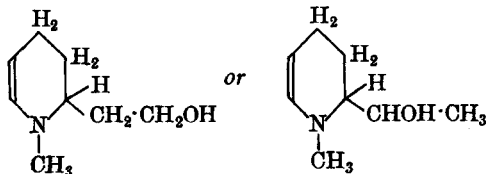

Merling (1891), by the oxidation of tropine with chromium trioxide, obtained ( $\pm$ )-tropic acid.

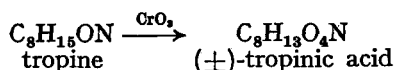

Tropic acid is a dicarboxylic acid, and since there is no loss of carbon in its formation, the hydroxyl group in tropine must therefore be in a ring system. Thus Ladenburg's formula is untenable, and so Merling proposed the following structures for tropine:

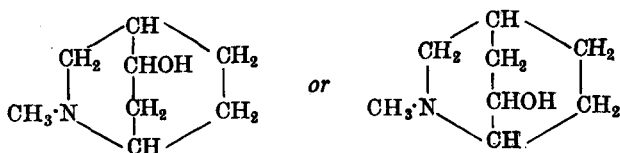

Willstätter (1895–1901) then examined the oxidation products of tropine obtained as follows:

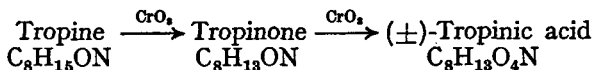

Tropinone behaved as a ketone; thus tropine is a secondary alcohol (*cf.* Merling's formula). Willstätter (1897) also showed that tropinone forms a dibenzylidene derivative with benzaldehyde, and a di-oximino derivative when treated with amyl nitrite and hydrochloric acid. Thus tropinone contains the  $\cdot\text{CH}_2\cdot\text{CO}\cdot\text{CH}_2\cdot$  grouping, and so it follows that Merling's formula is also untenable. Willstätter therefore proposed three possible structures for tropine, but eliminated two by the consideration of various reactions of tropine, and was left with the following (which contains a pyridine and a pyrrole nucleus with the nitrogen atom common to both):

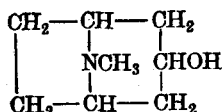

Not only did this fit the facts best, but it was also supported by the following evidence: (i) Exhaustive methylation of tropine gives tropilidene (*cycloheptatriene*),  $\text{C}_7\text{H}_8$ . (ii) Exhaustive methylation of tropic acid gives an unsaturated dicarboxylic acid which, on reduction, forms pimelic acid.

All the foregoing reactions of tropine can be readily explained on the Willstätter formula.

Formation of 2-ethylpyridine from tropine.

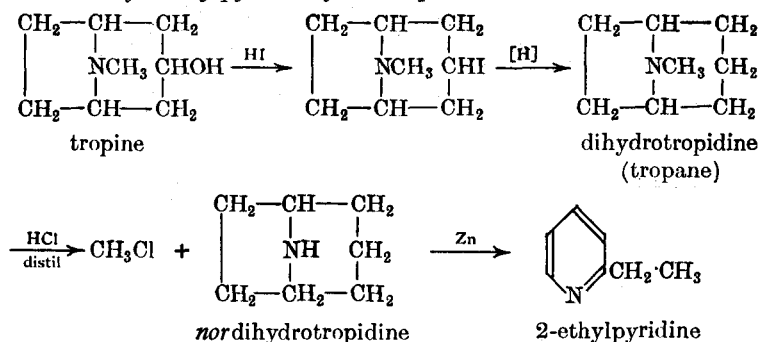

Formation of tropinone and tropinic acid from tropine.

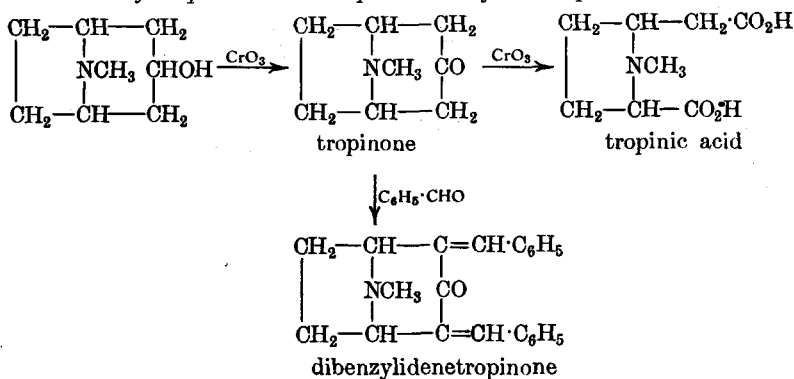

Formation of tropilidene from tropine.

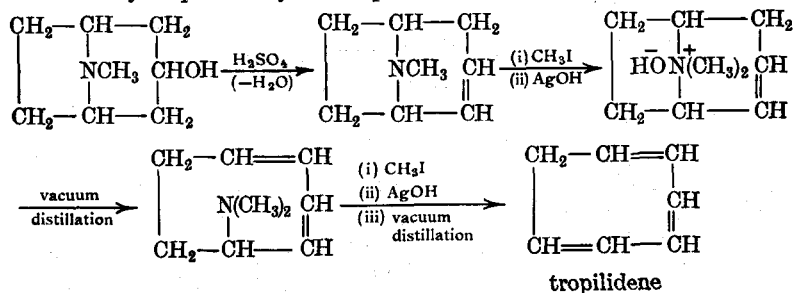

Formation of pimelic acid from tropinic acid.

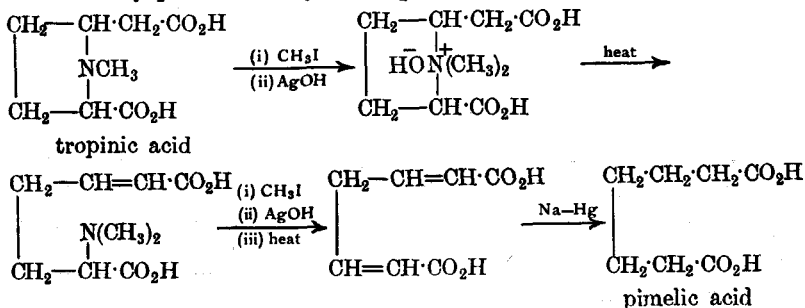

The structure of tropine has been confirmed by synthesis, one by Willstätter (1900-1903), and the other by Robinson (1917).

*Willstätter's synthesis.*

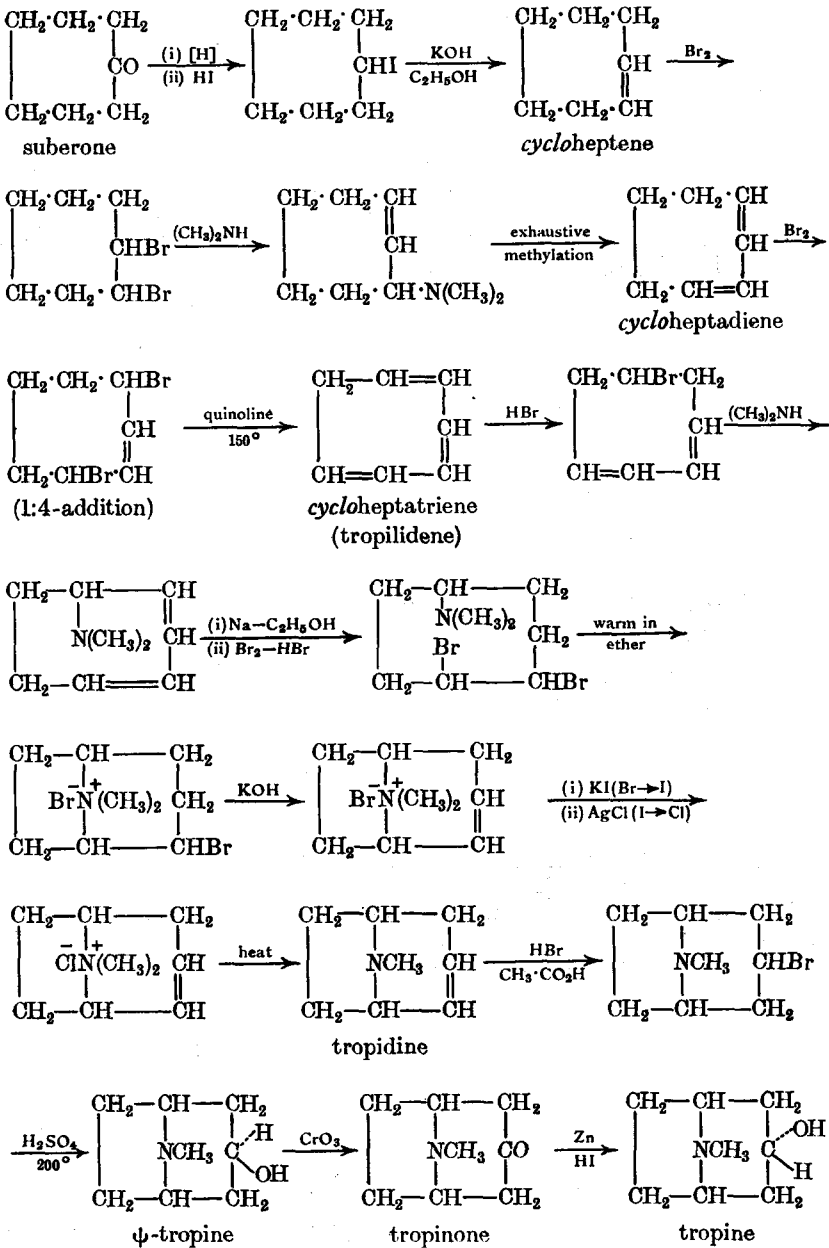

*Robinson's synthesis.*

When a mixture of succinaldehyde, methylamine and acetone is allowed to stand in water for thirty minutes, tropinone is produced in very small yield.

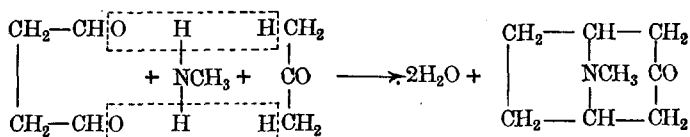

A much better yield (40 per cent.) is obtained by using calcium acetonedicarboxylate or ethyl acetonedicarboxylate instead of acetone; the calcium salt or ester so produced is converted into tropinone by warming with hydrochloric acid, *e.g.* ( $\text{ca} = \text{Ca}/2$ ):

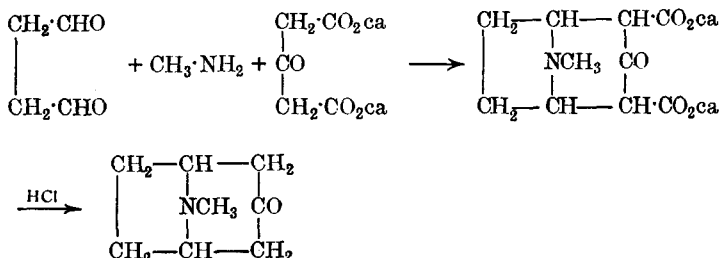

Schöpf *et al.* (1935) have obtained a yield of 70–85 per cent. by carrying out Robinson's synthesis at a *pH* of 7. Elming *et al.* (1958) have also synthesised tropinone using methylamine hydrochloride, acetonedicarboxylic acid and generating succinaldehyde *in situ* by the action of acid on 2,5-dimethoxytetrahydrofuran:

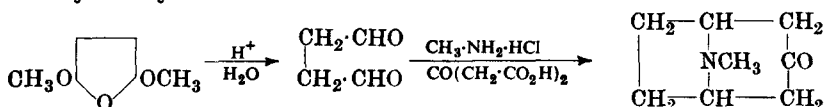

The yield was 81 per cent., but in this case "physiological conditions" were not necessary (see §28).

The final problem is to combine tropine with tropic acid; this has been done by heating the two together in the presence of hydrogen chloride (Fischer-Speier esterification; see Vol. I).

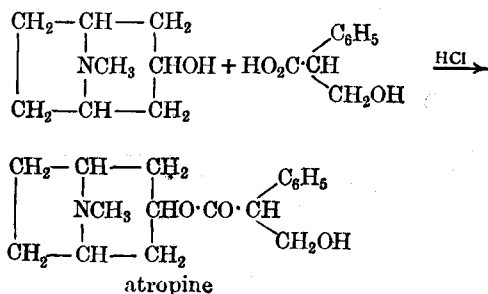

**Stereochemistry of the tropines.** Tropinone can be reduced to tropine, together with a small amount of  $\psi$ -tropine, by means of a metal and

acid, the best combination being zinc dust and hydriodic acid; or by means of electrolytic reduction. On the other hand, reduction with sodium amalgam converts tropinone into  $\psi$ -tropine. According to Mirza (1952), lithium aluminium hydride reduces tropinone quantitatively to  $\psi$ -tropine, but according to Beckett *et al.* (1957), 54 per cent. of  $\psi$ -tropine and 45 per cent. of tropine are obtained. A larger yield of the former (69 per cent.) is obtained with sodium borohydride, and reduction with sodium and isobutanol (in toluene) gives the maximum yield of  $\psi$ -tropine (88 per cent.).

Tropine and  $\psi$ -tropine are geometrical isomers, one isomer having the hydrogen atom on  $C_3$  on the same side as the nitrogen bridge, and the other isomer has this hydrogen atom on the opposite side (*cf.* the borneols, §23b. VIII); Fig. 1 shows the two possible forms. Neither of these forms is optically

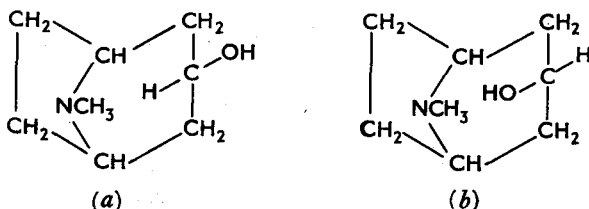

FIG. 14.1.

active, since the molecule has a plane of symmetry.  $C_1$  and  $C_5$  are asymmetric, but the molecule is optically inactive by internal compensation (see §7b. II), and so each isomer is a *meso*-form;  $C_3$  is pseudo-asymmetric (see §8. IV). It should also be noted that another pair of *optically active forms* would exist if the fusion of the nitrogen bridge were *trans*; this, however, is not possible (*cf.* camphor, §23a. VIII; also cocaine, §23).

The problem now is to decide which geometrical isomer (of the two forms shown in Fig. 1) is tropine and which is  $\psi$ -tropine. Fodor (1953) has given evidence to show that  $\psi$ -tropine is the *syn*-compound (nitrogen bridge and hydroxyl group are in the *cis*-position; Fig. 1 *b*), and that tropine is the *anti*-compound (nitrogen bridge and hydroxyl group are in the *trans*-position; Fig. 1 *a*). The problem, however, is more involved than this, since the conformation of the piperidine ring has also to be considered. Fodor gives the configuration of the piperidine ring as the boat form in both isomers (Fig. 2).

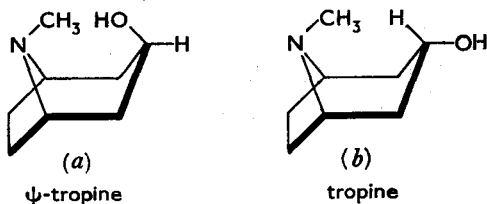

FIG. 14.2.

Zenitz *et al.* (1952) and Clemo *et al.* (1953) support these configurations from evidence obtained by measurements of the dipole moments of these two isomers;  $\psi$ -tropine has been shown to have a higher dipole moment than tropine. Zenitz *et al.* have also shown from infra-red absorption spectra measurements that  $\psi$ -tropine has intramolecular hydrogen bonding; this is only possible in the *syn*-form. Bose *et al.* (1953), however, have assumed the chair form for the piperidine ring by analogy with the chair conformation of *cyclohexane* compounds and pyranosides (see §11. IV). Thus these authors have suggested that  $\psi$ -tropine is Fig. 3 (a), in which the hydroxyl

group is equatorial, and that tropine is Fig. 3 (b), in which the hydroxyl group is axial.

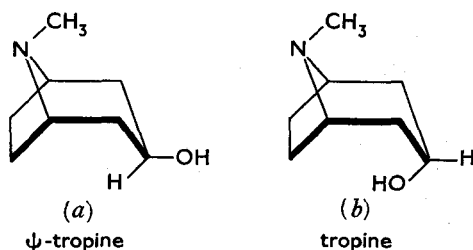
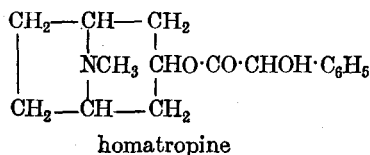

FIG. 14.3.

If these be the configurations, then it is difficult to explain Fodor's work (which involves rearrangements), and also the fact that there is intramolecular hydrogen bonding in  $\psi$ -tropine. Sparke (1953) has suggested that the chair form can readily change into the boat form; this would then explain the intramolecular hydrogen bonding. Archer and Lewis (1954) also adopt this explanation, but make the assumption that the bond energy involved in the hydrogen bond is sufficient to transform, at least partially, the more stable chair form into the less stable boat form; in  $\psi$ -tropine the chair and boat forms are in mobile equilibrium, the latter being the predominant form.

§22a. **Tropeines and pseudotropeines.** These are synthetic esters formed respectively from tropine and  $\psi$ -tropine with various organic acids. The tropeines (including atropine itself) are powerful mydriatics (pupil dilators) and feeble anaesthetics; the  $\psi$ -tropeines are the reverse. One of the most important tropeines is *homatropine (mandelyltropeine)*, which is prepared by combining tropine with mandelic acid.



§22b. **Hyoscine (scopolamine)**,  $\text{C}_{17}\text{H}_{21}\text{O}_4\text{N}$ , is a syrup and is laevorotatory; it is obtained from various sources, e.g., *Datura Metel*. Hyoscine is a constituent of travel sickness tablets, and when administered with morphine, produces "twilight sleep". Hyoscine is the (–)-tropic ester of the aminoalcohol *scopine*; these two compounds are produced by the hydrolysis of hyoscine with ammonia.

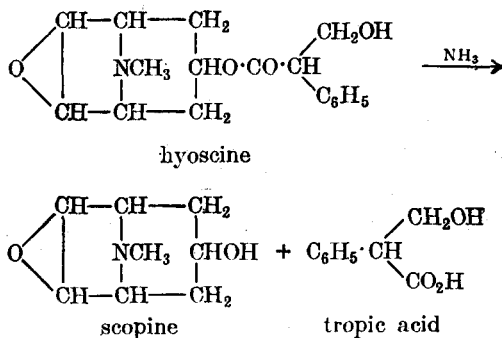

More vigorous hydrolysis of hyoscyne with acids or alkalis produces *oscine* (*scopoline*), which is formed by the isomerisation of scopoline.

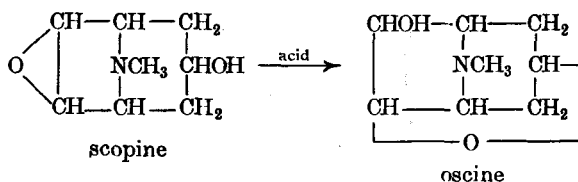

It is interesting to note, in this connection, that the action of *ethanolic* sodium hydroxide on (-)-hyoscyne at room temperature causes the latter

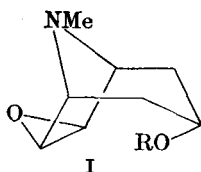

to racemise to ( $\pm$ )-hyoscyne. Fodor *et al.* (1959) have carried out a total synthesis of ( $\pm$ )-hyoscyne and shown its conformation to be



§23. **Coca alkaloids.** In this group occur cocaine, benzoylecgonine, tropacocaine, hygrine (§13), cuscohygrine (§13a), etc.

(-)-**Cocaine**,  $\text{C}_{17}\text{H}_{21}\text{O}_4\text{N}$ , m.p.  $98^\circ$ , occurs in coca leaves; it is sparingly soluble in water, but its hydrochloride is quite soluble and is used as a local anaesthetic. When heated with water, cocaine is hydrolysed to methanol and benzoylecgonine.

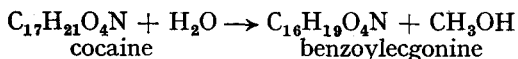

Thus cocaine contains a carbomethoxyl group, and benzoylecgonine a carbonyl group. When benzoylecgonine is heated with barium hydroxide solution, further hydrolysis occurs, the products obtained being benzoic acid and ecgonine.

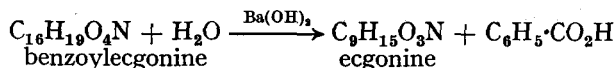

Ecgonine shows the reactions of an alcohol, and so benzoylecgonine is the benzoyl derivative of a hydroxycarboxylic acid. The structure of ecgonine has been deduced from the nature of the products obtained by oxidation, *viz.*,

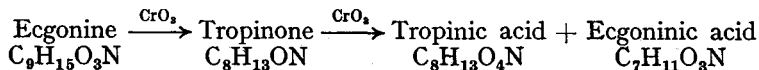

From these results, it follows that ecgonine contains the tropane structure and that the alcoholic group must be in the same position as in tropine (§22). Now in the formation of tropinone from ecgonine, a carboxyl group is lost (as we have seen, ecgonine contains a carboxyl group). Thus the carboxyl group is in a position such that the oxidation of the secondary alcoholic group in ecgonine to a keto group is accompanied by the elimination of the carboxyl group. This type of elimination is characteristic of  $\beta$ -keto acids, and this interpretation of the results is confirmed by the

fact that Willstätter *et al.* (1898) actually observed the formation of an unstable  $\beta$ -ketic acid which lost carbon dioxide to give tropinone. Thus ecgonine is:

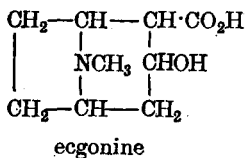

On this basis, the foregoing reactions may therefore be written:

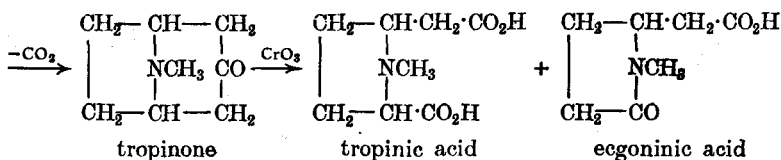
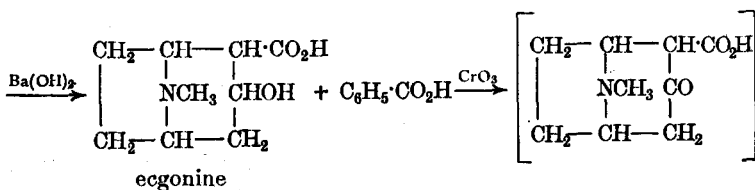
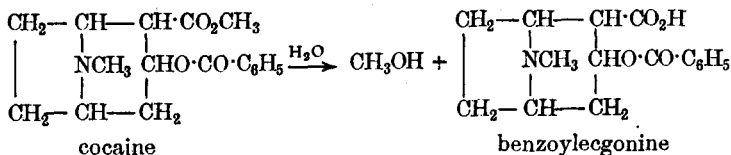

The structure of ecgonine has been confirmed by synthesis (Willstätter *et al.*, 1901); the starting point is tropinone (see §22 for its synthesis). Before describing this synthesis, let us first examine the structure of ecgonine from the stereochemical point of view; it will be seen that there are four dissimilar

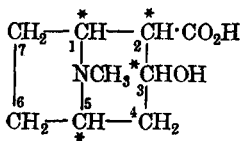

asymmetric carbon atoms present (\*), and so there are  $2^4 = 16$  optically active forms (eight pairs of enantiomorphs) possible (*cf.* tropine, §22). Since, however, only the *cis* fusion of the nitrogen bridge is possible in practice,  $\text{C}_1$  and  $\text{C}_5$  therefore have only one configuration (the *cis*-form), and so there are only eight optically active forms (four pairs of enantiomorphs) actually possible (*cf.* camphor, §23a. VIII); three pairs of enantiomorphs have been prepared synthetically.

In the original synthesis of Willstätter, the racemic ecgonine obtained was not identical with the (-)-ecgonine from (-)-cocaine, but its chemical properties were the same.



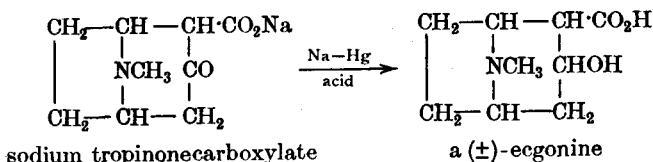
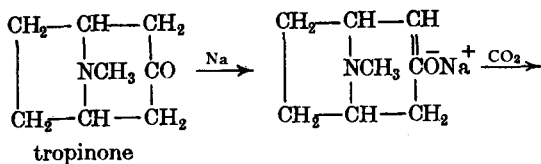

Later, Willstätter *et al.* (1921) synthesised ecgonine by means of the Robinson method (see §22):

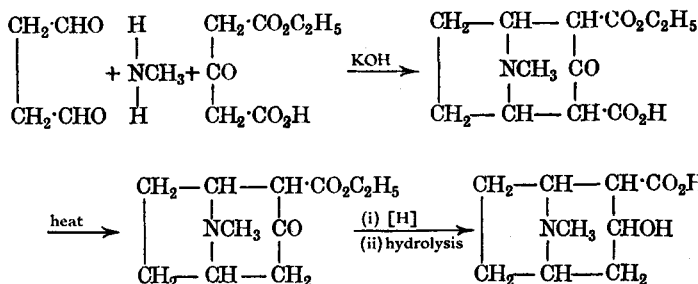

The final product was shown to be a mixture of three racemates, ( $\pm$ )-ecgonine, ( $\pm$ )-*ψ*-ecgonine and a third pair of enantiomorphs (Willstätter *et al.*, 1923). The racemic ecgonine was resolved, and the (–)-form esterified with methanol and then benzoylated; the product was (–)-cocaine.

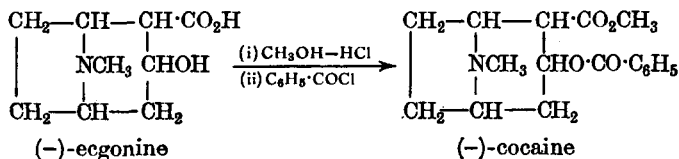

In a similar way, the (+)- and (–)-*ψ*-cocaines were obtained from the corresponding *ψ*-ecgonines. An interesting point in this connection is that Einhorn *et al.* (1890) showed that the prolonged action of 33 per cent. aqueous potassium hydroxide converts ecgonine into *ψ*-ecgonine, and Findlay (1953) has found that cocaine gives *ψ*-ecgonine methyl ester by the action of sodium methoxide in hot methanol.

Fodor *et al.* (1953, 1954) and Findlay (1953, 1954) have established the conformations of ecgonine and *ψ*-ecgonine (R = CO<sub>2</sub>H; R' = H) and the corresponding cocaines (R = CO<sub>2</sub>Me; R' = COPh) (*cf.* §22):

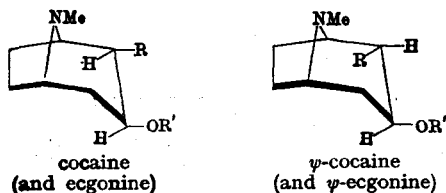

Hardegger *et al.* (1955) have correlated (-)-cocaine with L-glutamic acid and have shown that the formula represents the absolute configuration of L(-)-cocaine.

§23a. **Tropacocaine**,  $C_{15}H_{19}O_2N$ , m.p.  $49^\circ$ , occurs in Java coca leaves. When heated with barium hydroxide solution, tropacocaine is hydrolysed to  $\psi$ -tropine and benzoic acid; thus the alkaloid is benzoyl- $\psi$ -tropine.

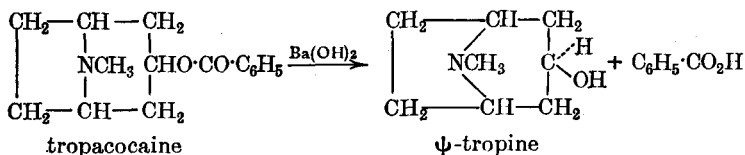

§23b. **Cocaine substitutes.** Cocaine is a very good local anaesthetic, but has certain disadvantages. The anaesthetic properties are lost if either the benzoyl group or the methyl ester group is removed; removal of the *N*-methyl group has no effect. A number of synthetic drugs have now been introduced to replace cocaine as a local anaesthetic; their anaesthetic properties are as good as those of cocaine, and they are less toxic. Two important substitutes are  $\beta$ -eucaine and procaine (novocaine).

$\beta$ -Eucaine has been synthesised by treating acetone with ammonia and then treating the product, diacetonamine (see Vol. I), with diethyl acetal. The piperidone thereby produced is then reduced and finally benzoylated to give  $\beta$ -eucaine.

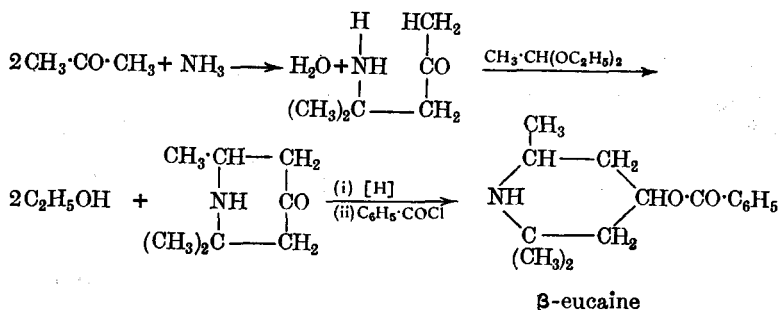

Procaine has been synthesised from *p*-nitrobenzoic acid.

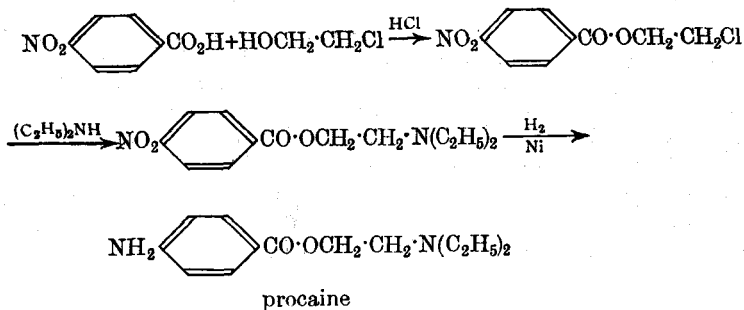

### QUINOLINE GROUP

§24. **Angostura alkaloids.** A number of alkaloids have been isolated from angostura bark, *e.g.*, cusparine, galipine, galipoline, etc.

**Cusparine**,  $C_{19}H_{17}O_3N$ , m.p.  $90-91^\circ$ , has been shown to contain one methoxyl group (Zeisel method), and when fused with potassium hydroxide, protocatechuic acid is obtained.

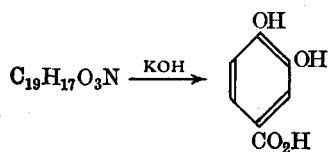

On the other hand, controlled oxidation of cusparine gives piperonylic acid and 4-methoxyquinoline-2-carboxylic acid.

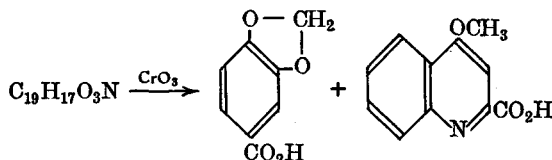

Consideration of this information led to the suggestion of the following structure for cusparine.

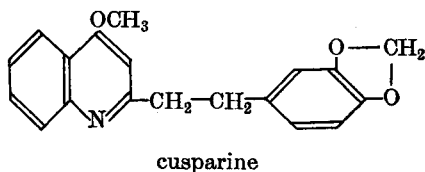

This has been confirmed by synthesis (Späth *et al.*, 1924).

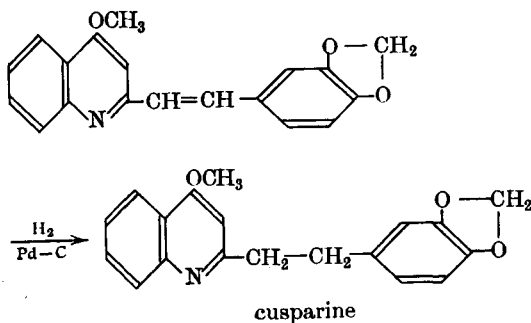
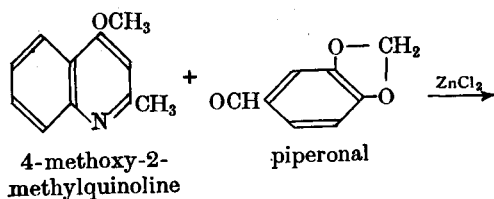

**Galipine**,  $C_{20}H_{21}O_3N$ , m.p.  $113^\circ$ , contains three methoxyl groups (Zeisel method). When oxidised with chromic acid, galipine produces 4-methoxyquinoline-2-carboxylic acid and veratric acid. Thus the formula of the alkaloid is probably:

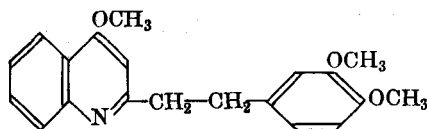

galipine

This has been confirmed by synthesis (Späth *et al.*, 1924).

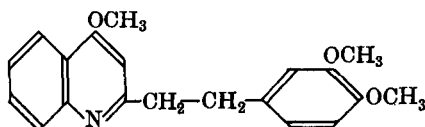
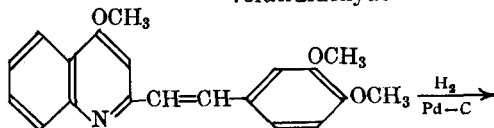
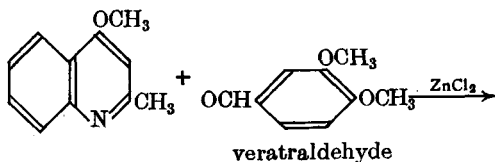

galipine

**Galipoline**,  $C_{19}H_{19}O_3N$ , m.p.  $193^\circ$ , contains two methoxyl groups and one phenolic group. When methylated with diazomethane, galipoline is converted into galipine. Thus one of the methoxyl groups in the latter is a hydroxyl group in the former. The position of this phenolic hydroxyl was shown to be in the quinoline nucleus by synthesis (Späth *et al.*, 1924).

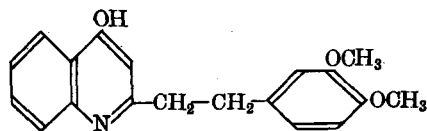
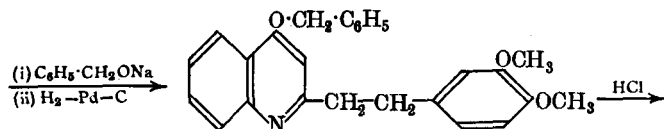
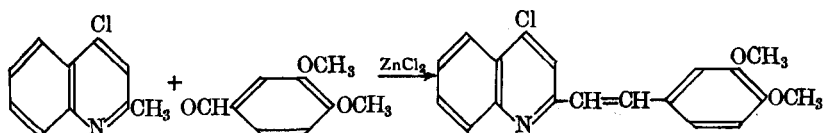

galipoline

**§25. Cinchona alkaloids.** Cinchonine and quinine, together with many other alkaloids, occur in the bark of various species of *Cinchona*. Cinchonine may be regarded as the parent substance of the cinchona alkaloids,

but quinine is the most important member of this group, its main use being in the treatment of malaria.

§25a. (+)-Cinchonine,  $C_{19}H_{22}ON_2$ , m.p.  $264^\circ$ , adds on two molecules of methyl iodide to form a di-quaternary compound; thus the alkaloid is a di-tertiary base. Since cinchonine forms a mono-acetate and a mono-benzoate, the molecule contains one hydroxyl group. Furthermore, this hydroxyl group is secondary alcoholic, since on oxidation, cinchonine forms the ketone *cinchoninone*. Cinchonine has been shown to contain one ethylenic double bond by the fact that it adds on one molecule of bromine or halogen acid, and that it is readily catalytically reduced, one molecule of hydrogen being added on.

Fusion of cinchonine with potassium hydroxide gives lepidine (4-methylquinoline), I, and on vigorous oxidation with chromic acid in sulphuric acid solution, cinchoninic acid, II, is obtained (Königs, 1894). Thus cinchonine

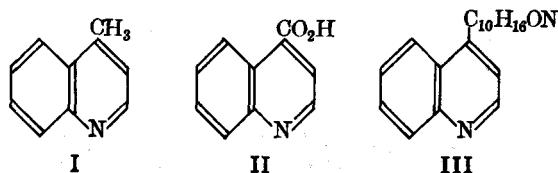

contains a quinoline nucleus with a side-chain in position 4 (III); this side-chain was referred to by Skraup as the "second-half" of the molecule. The hydroxyl group in cinchonine must be in this "second-half", since if it were not, then a hydroxy derivative or a carboxy derivative (since the hydroxyl is alcoholic) of cinchoninic acid would have been obtained.

Oxidation of cinchonine with permanganate gives cinchotinine and formic acid (Königs, 1879).

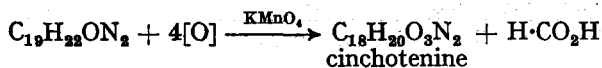

This suggests that there is a  $-\text{CH}=\text{CH}_2$  group in the side-chain in the "second-half".

When treated with phosphorus pentachloride, followed by ethanolic potassium hydroxide, cinchonine is converted into cinchene which, when heated with 25 per cent. phosphoric acid, forms lepidine and a compound Königs named meroquinene (Königs *et al.*, 1884). With the information obtained so far, we may formulate the work of Königs as follows:

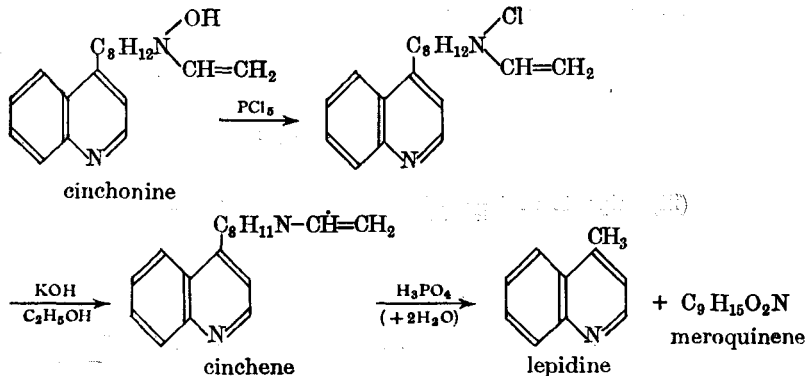

Meroquinene (meroquinene) is also obtained, together with cinchoninic acid, when cinchonine is oxidised with chromic acid (Königs, 1894).

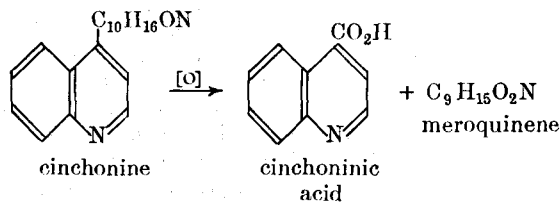

Thus the key to the structure of the "second-half" is the structure of meroquinene. The routine tests showed that meroquinene contains one carboxyl group and one double bond; the presence of the latter indicates that the  $-\text{CH}=\text{CH}_2$  side-chain is still present in meroquinene. Oxidation of meroquinene with cold acid permanganate produces formic acid and cincholoiponic acid, the latter being a dicarboxylic acid (Königs, 1879). The formation of formic acid confirms the presence of the  $-\text{CH}=\text{CH}_2$  side-

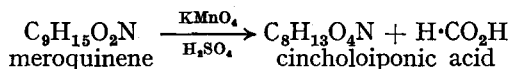

chain in meroquinene. The presence of this group has also been demonstrated by the ozonolysis of meroquinene; formaldehyde is produced (Seekles, 1923). Oxidation of cincholoiponic acid with acid permanganate produces loiponic acid,  $\text{C}_7\text{H}_{11}\text{O}_4\text{N}$  (Königs, 1890). This is also a dicarboxylic acid, and since it contains one methylene group less than its precursor cincholoiponic acid, this suggests that the latter contains at least a side-chain  $-\text{CH}_2\cdot\text{CO}_2\text{H}$ .

The reactions of the above three acids indicated that they were all secondary bases; that they all contained a piperidine ring is shown by the following reactions.

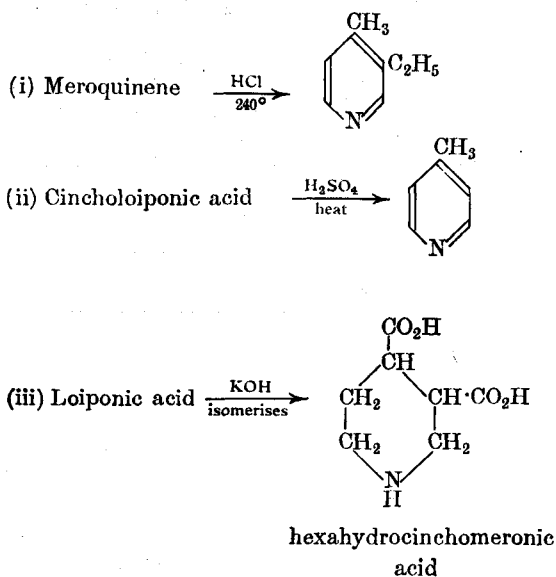

The structure of hexahydrocinchomeronic acid is known from its synthesis (*cf.* §21).

Consideration of the above results shows that a possible skeleton structure of meroquinene is:

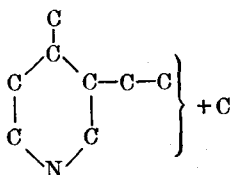

The problem then is to find the position of the remaining carbon atom. This carbon atom cannot be an *N*-methyl group, since all three acids are secondary bases. As we have seen, meroquinene contains a  $-\text{CH}=\text{CH}_2$  group in the side-chain. A possible position for the extra carbon atom is the side-chain containing this unsaturated group; *i.e.*, the side-chain is an allyl group,  $-\text{CH}_2\cdot\text{CH}=\text{CH}_2$ . All the foregoing facts can be explained on this basis, but the following fact cannot, *viz.*, that reduction of meroquinene gives cincholoipon,  $\text{C}_9\text{H}_{17}\text{O}_2\text{N}$ , a compound which contains one carboxyl group and one *ethyl group*. Thus the unsaturated side-chain cannot be allyl (this should have given a propyl group on reduction); the side-chain is therefore vinyl. This leaves only one possible position for the extra carbon atom, *viz.*, 4; this would give a  $-\text{CH}_2\cdot\text{CO}_2\text{H}$  group at this position, and the presence of such a group has already been inferred (see above). All the reactions of meroquinene can therefore be explained on the following structures:

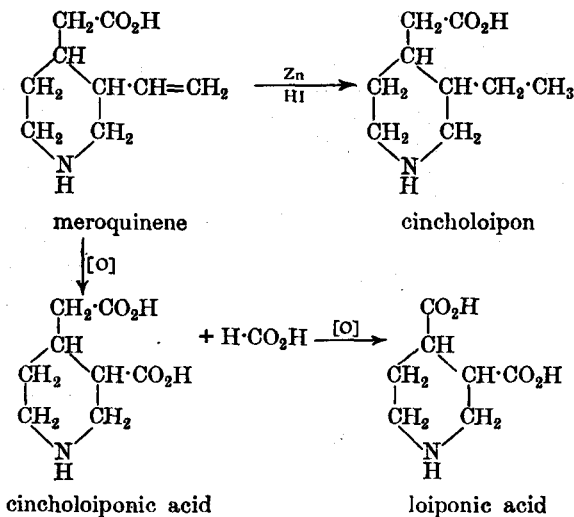

This formula for meroquinene is supported by the synthesis of cincholoiponic acid (Wohl *et al.*, 1907; *cf.* §17) (see next page).

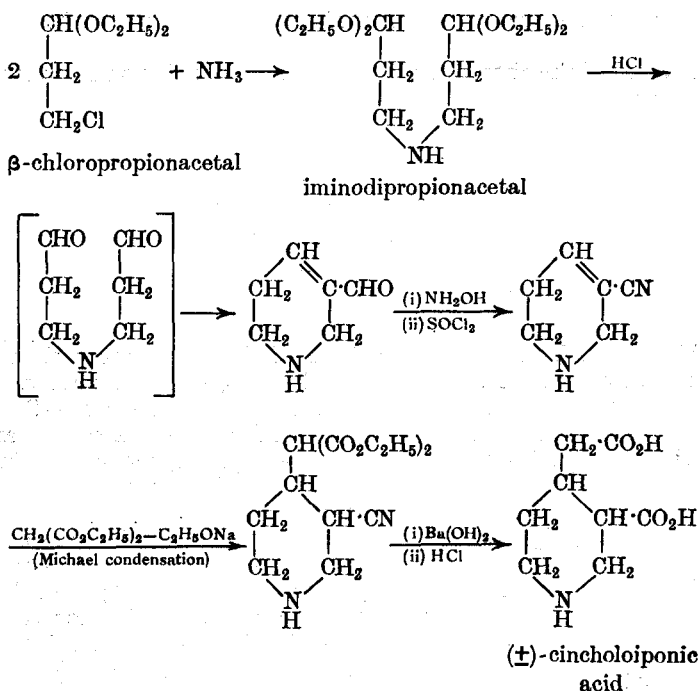

The racemic cincholoiponic acid was acetylated, and then this derivative was resolved by means of brucine; the (+)-form was identical with the acid obtained from meroquinene.

Since meroquinene is obtained from cinchonine by oxidation, the carbon atom of the carboxyl group in meroquinene will be the point of linkage to the "quinoline-half" at which scission of the "second-half" occurs. Since cinchonine is a di-tertiary base, the "second-half" therefore contains a tertiary nitrogen atom. But meroquinene is a secondary base, and it therefore follows that in its formation the tertiary nitrogen atom is converted into a secondary nitrogen atom, a carboxyl group also being produced at the same time. A possible explanation for this behaviour is that the tertiary nitrogen atom is a part of a bridged ring, one C—N bond being broken when cinchonine is oxidised:

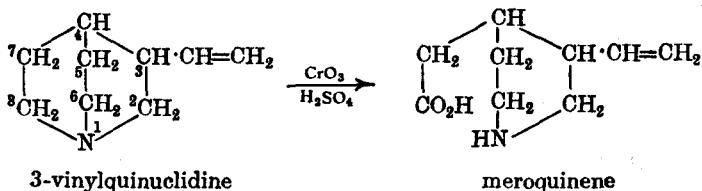

Thus, in cinchonine, the "quinoline-half" must be joined *via* its side-chain at position 4 to the "quinuclidine-half" at position 8. The remaining problem is to ascertain the position of the secondary alcoholic group in the "second-half". Rabe *et al.* (1906, 1908) converted cinchonine into the ketone cinchoninone by gentle oxidation (chromium trioxide). This ketone, in which both nitrogen atoms are still tertiary, on treatment with amyl



nitrite and hydrogen chloride, gives cinchoninic acid and an oxime. The formation of an acid and an oxime indicates the presence of the group

$-\text{CO}\cdot\text{CH}-$ , *i.e.*, a methyne group adjacent to a carbonyl group:

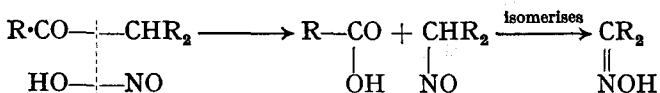

The structure of the oxime obtained from cinchoninone was shown to be 8-oximino-3-vinylquinuclidine by its hydrolysis to hydroxylamine and meroquinene. If we assume that the secondary alcoholic group connects the "quinoline-half" to the quinuclidine nucleus, then the foregoing reactions may be written as follows, on the assumption that the structure of cinchonine is as given.

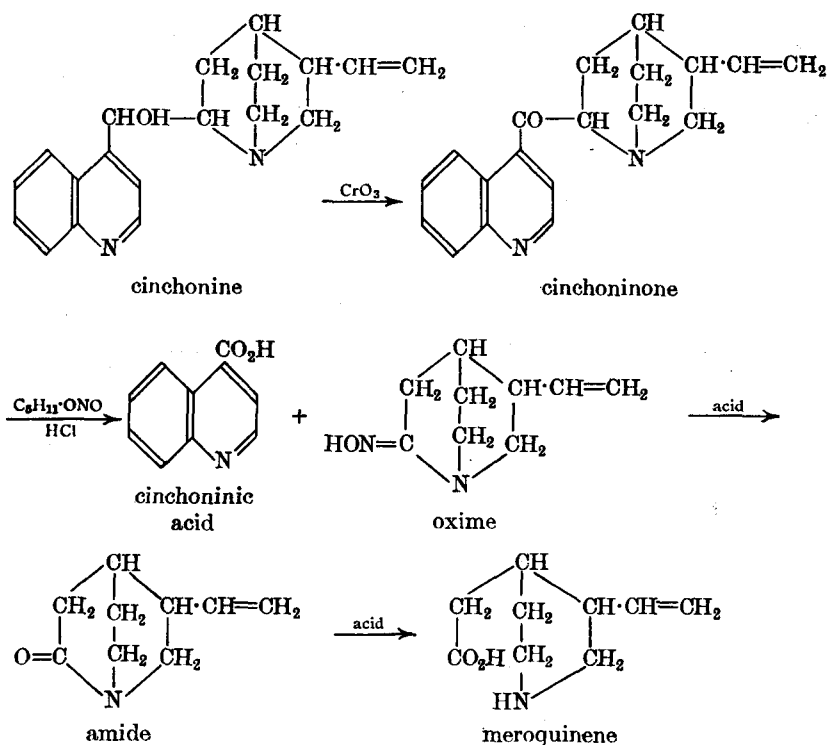

The above structure of cinchonine contains four dissimilar asymmetric carbon atoms, *viz.*, 3, 4, 8, and the carbon atom of the  $\text{CHOH}$  group (see 3-vinylquinuclidine for numbering). One pair of enantiomorphs is  $(\pm)$ -cinchonine, and another pair is  $(\pm)$ -cinchonidine; the configurations of  $\text{C}_3$  and  $\text{C}_4$  are the same in both, since both give the *same* 8-oximino-3-vinylquinuclidine (see §25b).

A partial synthesis of cinchonine has been carried out by Rabe (1911, 1913). This starts from cinchotoxine, which is prepared by the prolonged action of acetic acid on cinchonine; the latter isomerises (Rabe *et al.*, 1909).

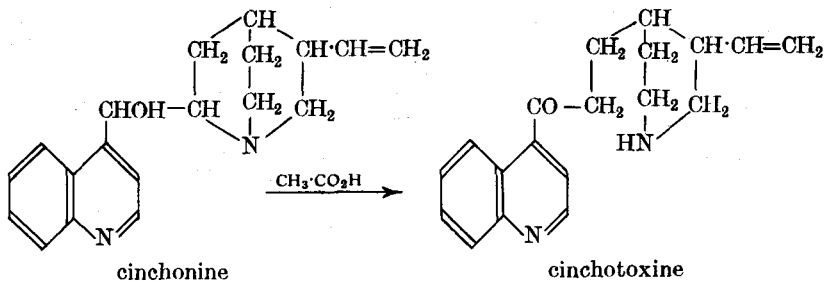

This isomerisation is an example of the *hydramine fission* (see §7). The conversion of cinchotoxine into cinchonine was carried out as follows:

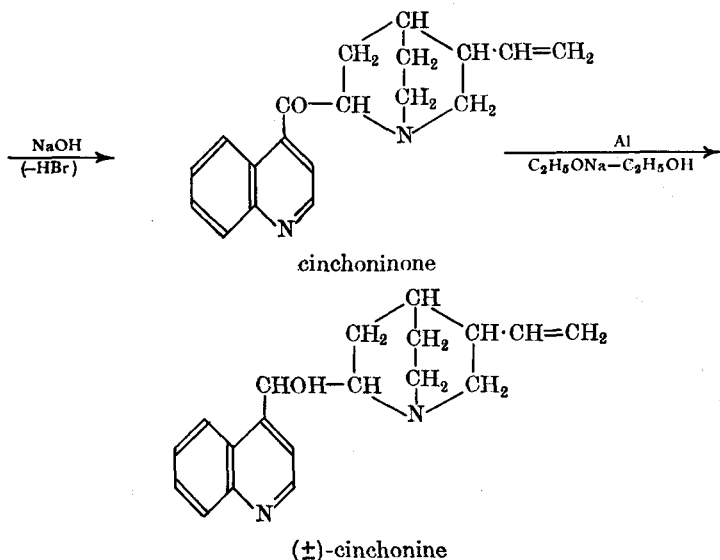
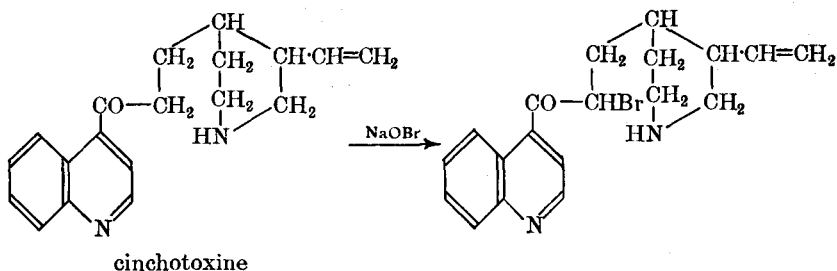

§25b. (–)-**Quinine**,  $\text{C}_{20}\text{H}_{24}\text{O}_2\text{N}_2$ , m.p.  $177^\circ$ , is used as a febrifuge and as an antimalarial. Since quinine adds on two molecules of methyl iodide to form a di-quaternary salt, it is therefore a di-tertiary base. When heated with hydrochloric acid, quinine eliminates one carbon atom as methyl chloride; therefore there is one methoxyl group present in the molecule. Since quinine forms a mono-acetate and a mono-benzoate, one hydroxyl group must be present, and that this is secondary alcoholic is shown by the fact that oxidation of quinine with chromium trioxide produces quinone, a ketone.

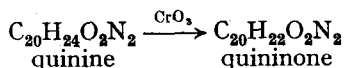

Quinine also contains one ethylenic double bond, as is shown by the fact that it adds on one molecule of bromine, etc. (*cf.* cinchonine). Oxidation of quinine with chromic acid produces, among other products, quininic acid.

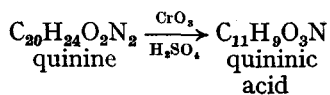

On the other hand, controlled oxidation of quinine with chromic acid gives quininic acid and meroquinene. Thus the "second-half" in both quinine and cinchonine is the same, and so the problem is to elucidate the structure of quininic acid. When heated with soda-lime, quininic acid is decarboxylated to a methoxyquinoline, and since, on oxidation with chromic acid, quininic acid forms pyridine-2:3:4-tricarboxylic acid, the methoxyl group must be a substituent in the benzene ring (of quinoline), and the carboxyl group at position 4 (Skraup, 1881). The position of the methoxyl group was ascertained by heating quininic acid with hydrochloric acid and then

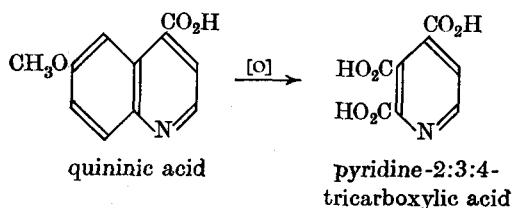

decarboxylating the demethylated product; 6-hydroxyquinoline (a known compound) was obtained. Thus quininic acid is 6-methoxycinchonic acid.

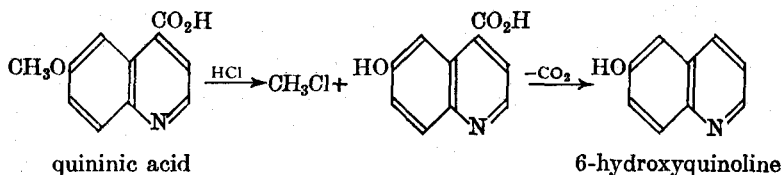

This structure for quininic acid has been confirmed by synthesis (Rabe *et al.*, 1931).

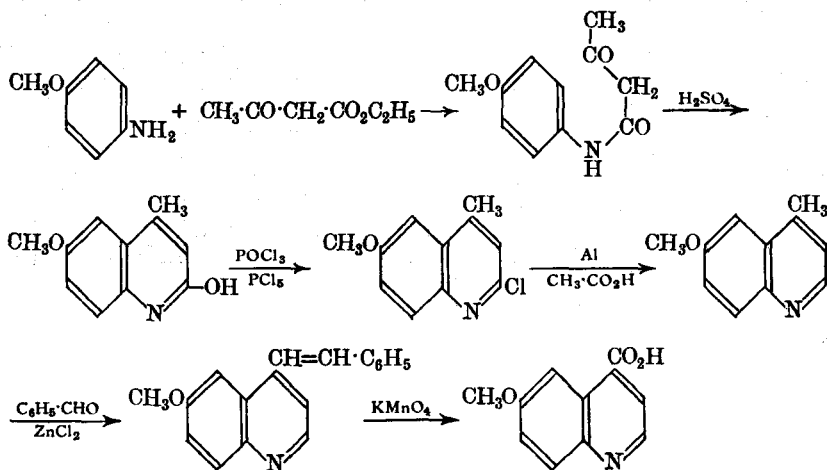

The direct oxidation of 6-methoxy-4-methylquinoline to quinic acid is extremely difficult; oxidation of the methyl group is accompanied by the oxidation of the benzene ring, the final product being pyridine-2:3:4-tricarboxylic acid (see §26).

Thus, on the basis of the foregoing evidence, the structure of quinine is:

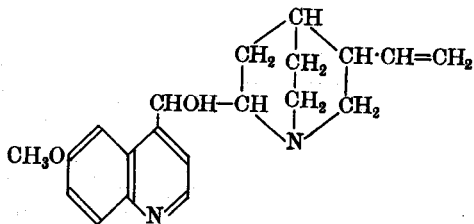

quinine

This formula contains the same four asymmetric carbon atoms as cinchonine; thus the same number of pairs of enantiomorphs is possible. One pair is ( $\pm$ )-quinine, and another pair is ( $\pm$ )-quinidine; the configurations of  $C_3$  and  $C_4$  are the same in quinine, quinidine, cinchonine and cinchonidine, since all four give the same 8-oximino-3-vinylquinuclidine (see §25a).

Rabe *et al.* (1918) carried out a partial synthesis of quinine starting from quinotoxine, which is prepared by heating quinine in acetic acid (*cf.* cinchotoxine). Woodward and Doering (1944) have synthesised (+)-quinotoxine, and so we now have a *total* synthesis of quinine. The following is Woodward and Doering's work up to (+)-quinotoxine, and from this to quinine is Rabe's work. *m*-Hydroxybenzaldehyde (I) is condensed with aminoacetal (II) and the product, 7-hydroxyisoquinoline (III), is treated with formaldehyde in methanol solution containing piperidine. The complex formed (IV) is converted into 7-hydroxy-8-methylisoquinoline (V) by heating with methanolic sodium methoxide at 220°. V, on catalytic reduction (platinum) followed by acetylation, gives *N*-acetyl-7-hydroxy-8-methyl-1:2:3:4-tetrahydroisoquinoline (VI), which, on further catalytic reduction by heating with a Raney nickel catalyst under pressure and then followed by oxidation with chromium trioxide, is converted into *N*-acetyl-7-keto-8-methyldecahydroisoquinoline (VII). VII is a mixture of *cis*- and *trans*-isomers; these were separated and the *cis*-isomer (VIIa; see §11 vii. IV for conventions) then treated with ethyl nitrite in the presence of sodium ethoxide to give the homomeroquinene derivative VIII. This, on reduction, gives IX, which may now be written more conveniently as shown. Exhaustive methylation of IX, followed by hydrolysis, gives *cis*-( $\pm$ )-homomeroquinene (X). X, after esterification and benzylation, gives XI which, on condensation with ethyl quinate (XII), produces XIII. This, on heating with 16 per cent. hydrochloric acid, is hydrolysed and decarboxylated to ( $\pm$ )-quinotoxine (XIV). This was resolved *via* its dibenzoyltartrate (tartaric acid proved unsuccessful for resolution). The conversion of ( $\pm$ )-quinotoxine into quinine had already been accomplished by Rabe *et al.* (the equations for this conversion are also given below).

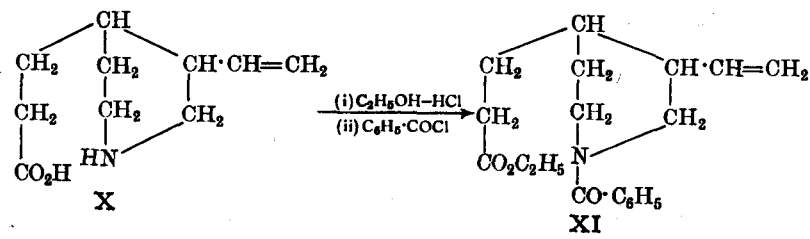
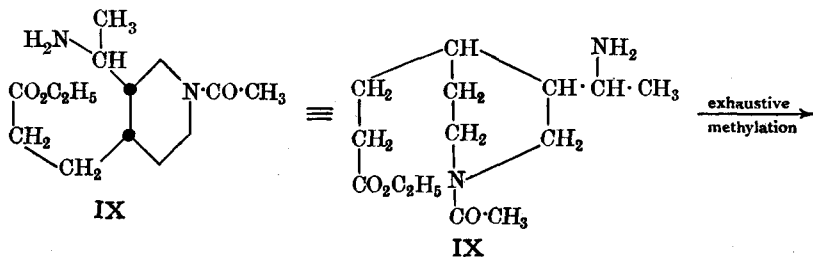
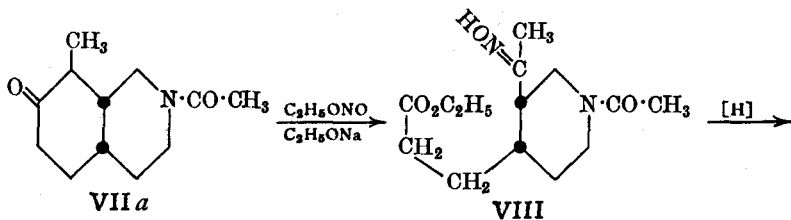
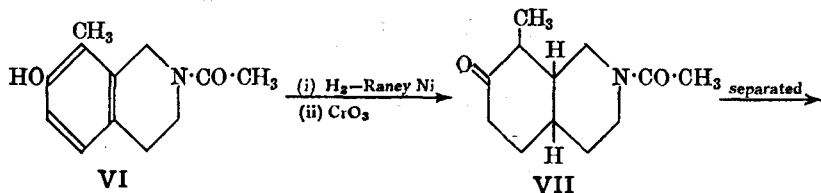
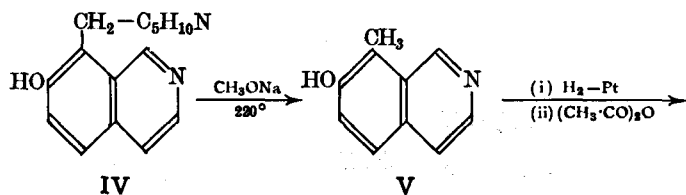
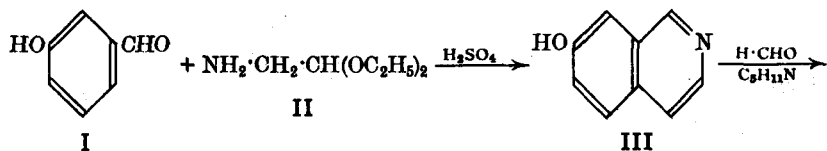

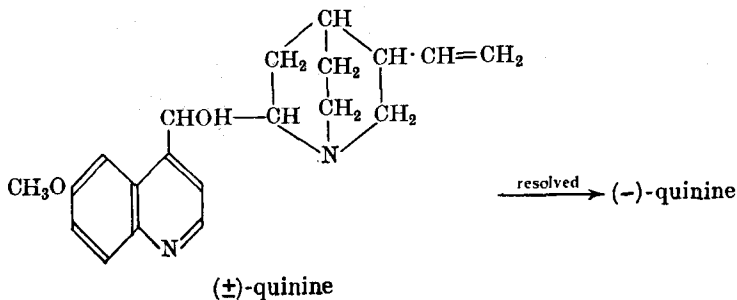
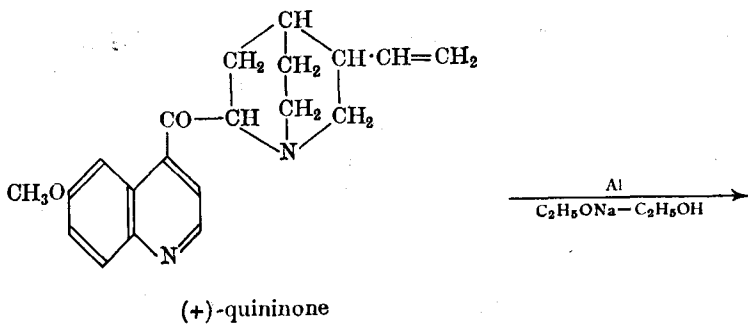
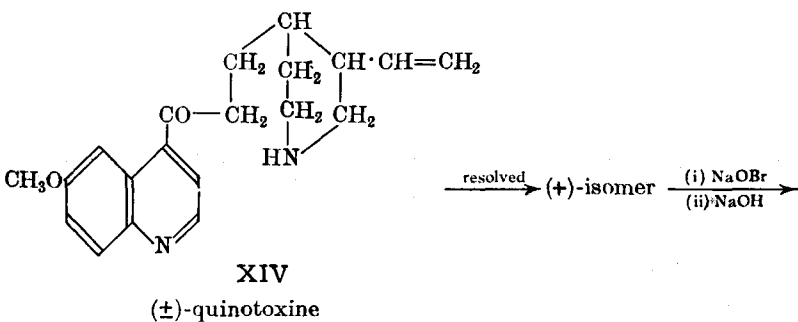
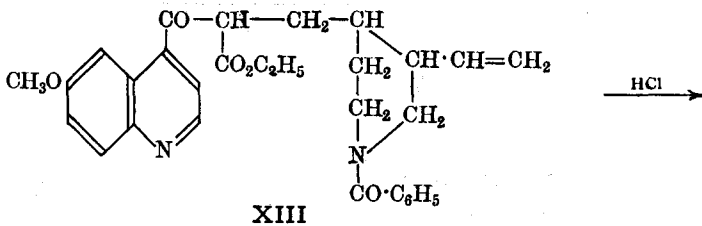
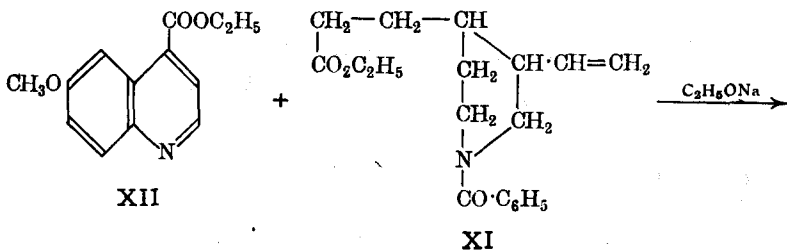

## ISOQUINOLINE GROUP

**Opium alkaloids.** Many alkaloids have been isolated from opium, and they are divided into two groups according to the nature of their structure:

- (i) *isoQuinoline group*, e.g., papaverine, laudanosine, etc.
- (ii) *Phenanthrene group*, e.g., morphine (see §27).

§26. **Papaverine**,  $C_{20}H_{21}O_4N$ , m.p.  $147^\circ$ , is one of the optically inactive alkaloids; it does not contain any asymmetric carbon atom. The structure of papaverine was established by Goldschmiedt and his co-workers (1883–1888). Since papaverine adds on one molecule of methyl iodide to form a quaternary iodide, the nitrogen atom in the molecule is in the tertiary state. The application of the Zeisel method shows the presence of four methoxyl groups; the demethylated product is known as papaveroline.

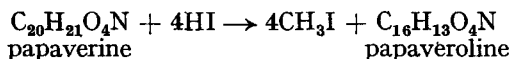

When oxidised with cold dilute permanganate, papaverine is converted into the secondary alcohol papaverinol,  $C_{20}H_{21}O_5N$ . This, on more vigorous oxidation with hot dilute permanganate, is oxidised to the ketone papaveraldine,  $C_{20}H_{19}O_5N$  (it is the formation of this *ketone* that shows that papaverinol is a *secondary* alcohol). Finally, the prolonged action of hot permanganate oxidises papaveraldine to papaverinic acid,  $C_{16}H_{13}O_7N$ . This acid is a dibasic acid and still contains the keto group present in its precursor—it forms an oxime, etc.; papaverinic acid also contains two methoxyl groups. The foregoing reactions lead to the conclusion that papaverine contains a methylene group.

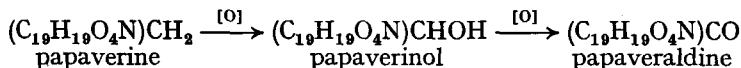

When oxidised with hot concentrated permanganate, papaverine (or the oxidised products mentioned above) is broken down into smaller fragments, *viz.*, veratric acid, metahemipinic acid, pyridine-2 : 3 : 4-tricarboxylic acid and 6 : 7-dimethoxyisoquinoline-1-carboxylic acid. Let us now consider the evidence for the structures of these compounds.

**Veratric acid.** When decarboxylated, veratric acid forms veratrole. Since this is *o*-dimethoxybenzene, veratric acid is therefore a dimethoxybenzoic acid. The position of the carboxyl group with respect to the two methoxyl groups (in the *ortho*-position) is established by the following synthesis.

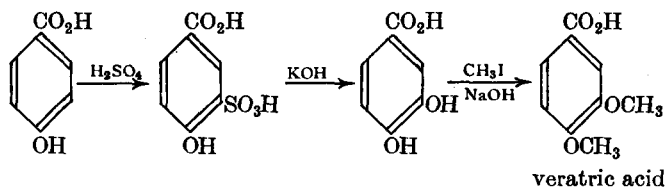

Thus veratric acid is 3 : 4-dimethoxybenzoic acid.

**Metahemipinic acid.** This is a dicarboxylic acid, and when decarboxylated by heating with calcium oxide, veratrole is formed; thus metahemipinic acid contains two methoxyl groups in the *ortho*-position. Furthermore, since the acid forms an anhydride when heated with acetic anhydride, the two carboxyl groups must be in the *ortho*-position. Thus metahemipinic acid is either I or II. Now metahemipinic acid forms only *one* monoester; II permits the formation of only one monoester, but I can give rise to two

different monoesters. Thus II is metahemipinic acid; I is actually hemipinic acid (this isomer was known before metahemipinic acid).

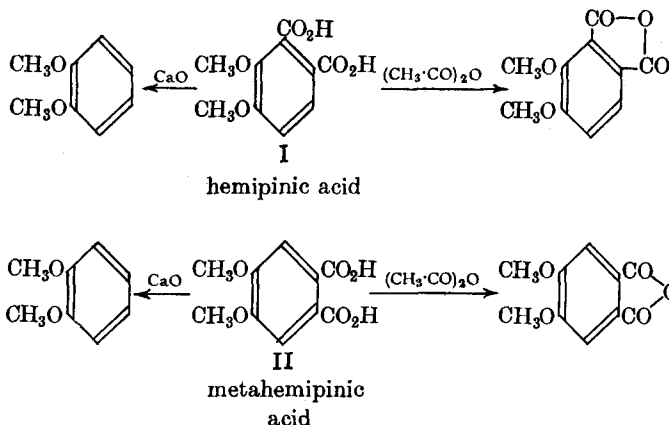

**Pyridine-2:3:4-tricarboxylic acid.** The routine tests showed that this contains three carboxyl groups, and since decarboxylation gives pyridine, the acid must be a pyridinetricarboxylic acid. The positions of the three carboxyl groups are established by the fact that this pyridinetricarboxylic acid is produced when lepidine (4-methylquinoline) is oxidised.

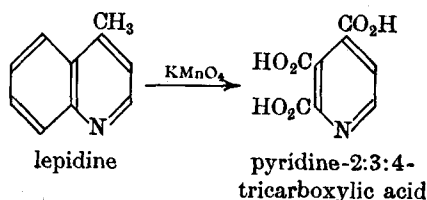

**6:7-Dimethoxyisoquinoline-1-carboxylic acid.** The usual tests showed that this compound contains one carboxyl group and two methoxy groups. On oxidation, this acid forms pyridine-2:3:4-tricarboxylic acid; when decarboxylated, the acid forms a dimethoxyisoquinoline which, on oxidation, gives metahemipinic acid; thus the structure is established.

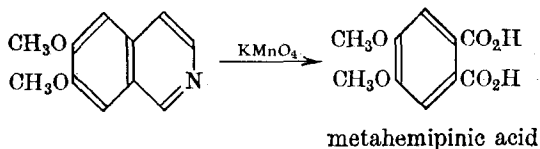
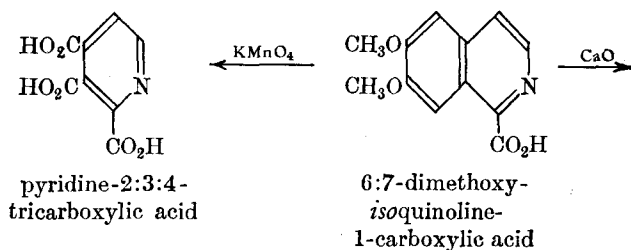



We may now deduce the structure of papaverine as follows:

(i) The isolation of veratric acid indicates the presence of group III in papaverine.

(ii) The isolation of 6:7-dimethoxyisoquinoline-1-carboxylic acid indicates the presence of group IV in the molecule.

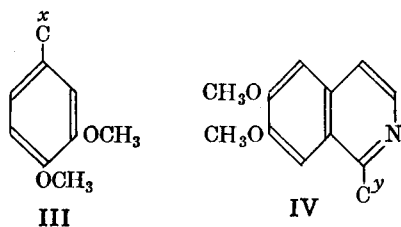

The presence of these two groups also accounts for the isolation of the other two fragments.

(iii) The total carbon content of III (9 carbon atoms) and IV (12 carbon atoms) is 21 carbon atoms. But papaverine contains only 20. There is, however, a  $-\text{CH}_2-$  group present, and if we assume that  $\text{C}^x$  and  $\text{C}^y$  are one and the same carbon atom, *viz.*, the carbon atom of the  $\text{CH}_2$  group, then the following structure of papaverine accounts for all the facts:

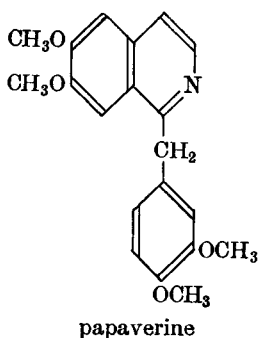

Thus, with this formula, we can formulate the oxidation of papaverine as follows:

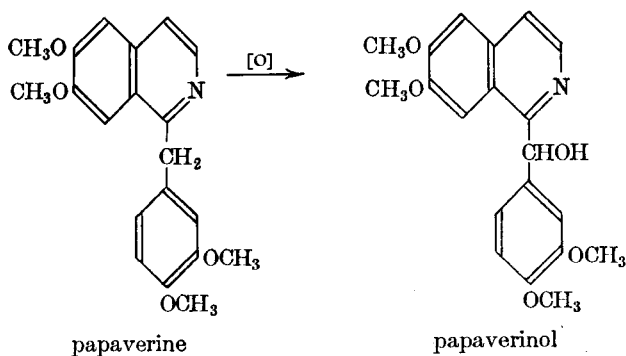

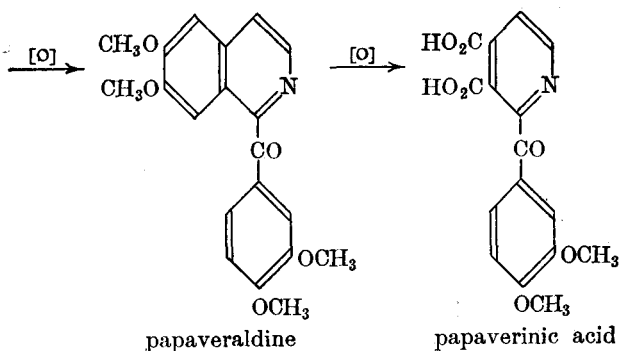

This structure for papaverine has been confirmed by synthesis. The first synthesis was by Pictet and Gams (1909), but Bide and Wilkinson (1945) carried out a simpler one, and it is this that is described here.

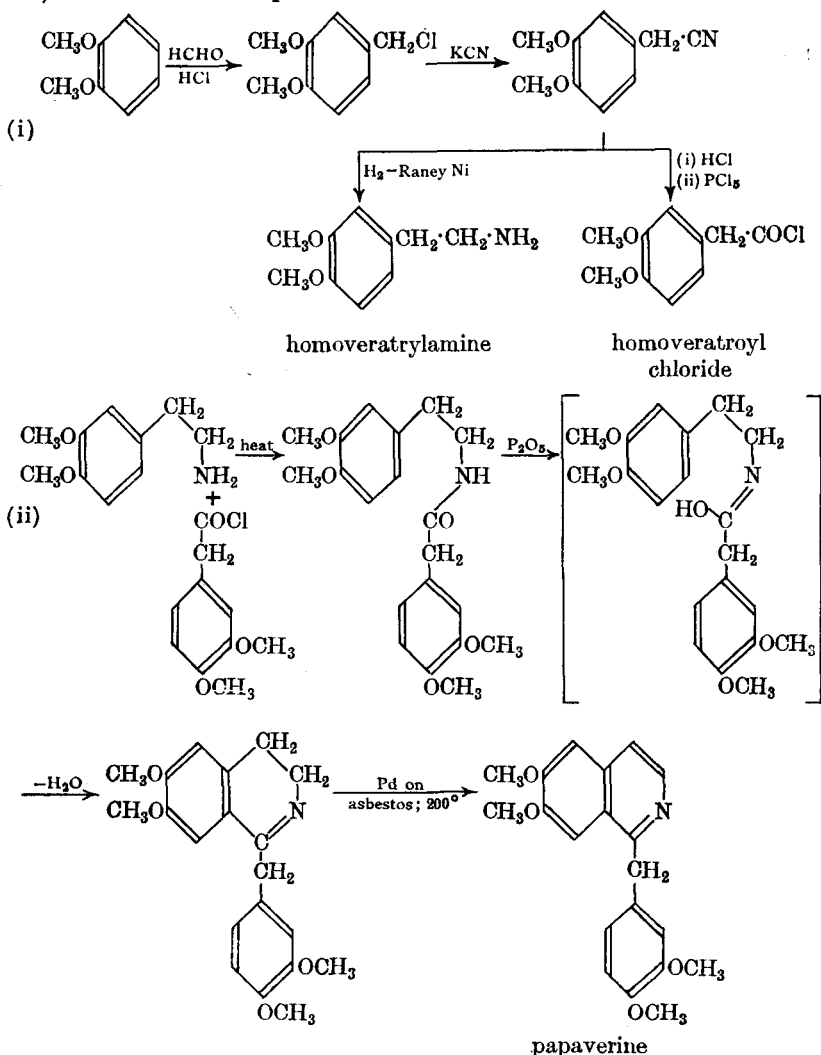

§26a. Some other alkaloids of the isoquinoline group are:

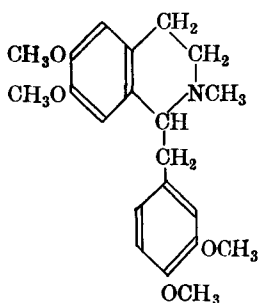

laudanose

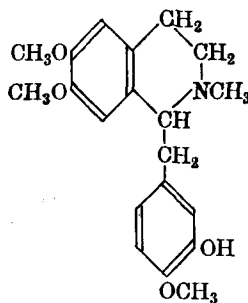

laudanine

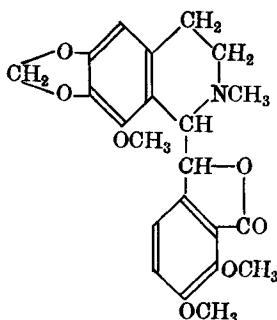

narcotine

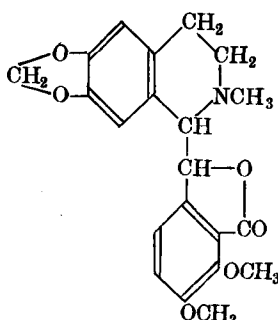

hydrastine

### PHENANTHRENE GROUP

§27. **Morphine, codeine and thebaine.** These are three important opium alkaloids which contain the phenanthrene nucleus.

(-)-*Morphine*,  $C_{17}H_{19}O_3N$ , m.p.  $254^\circ$ , is the chief alkaloid in opium, and was the first alkaloid to be isolated (Sertürner, 1806). The usual tests show that the nitrogen atom is in the tertiary state, and since morphine forms a diacetate and a dibenzoate, two hydroxyl groups are therefore present in the molecule. Morphine gives the ferric chloride test for phenols, and dissolves in aqueous sodium hydroxide to form a *monosodium* salt, and this is reconverted into morphine by the action of carbon dioxide; thus *one* of the hydroxyl groups is phenolic (Matthiessen *et al.*, 1869). The second hydroxyl group is secondary alcoholic, as is shown by the following reactions. Halogen acids convert morphine into a monohalogeno derivative, one hydroxyl group being replaced by a halogen atom. When heated with methyl iodide in the presence of aqueous potassium hydroxide, morphine is methylated to give (-)-*codeine*,  $C_{18}H_{21}O_3N$ , m.p.  $155^\circ$  (Grimaux, 1881). Since codeine is no longer soluble in alkalis, it therefore follows that it is only the *phenolic* hydroxyl group in morphine that has been methylated. Furthermore, codeine can be oxidised by chromic acid to *codeinone*, a ketone (Hesse, 1884). Thus the hydroxyl group in codeine (and this one in morphine) is secondary alcoholic, and so codeine is the monomethyl (phenolic) ether of morphine.

(-)-*Thebaine*,  $C_{19}H_{21}O_3N$ , m.p.  $193^\circ$ , produces two molecules of methyl iodide when heated with hydriodic acid (Zeisel method); hence thebaine is a dimethoxy derivative. When heated with sulphuric acid, thebaine

eliminates one methyl group as methyl hydrogen sulphate, and forms codeinone (Knorr, 1906). The formation of a *ketone* led Knorr to suggest that thebaine is the methyl ether of the *enolic* form of codeinone. The foregoing work can thus be summarised by assigning the following formulæ to the compounds described:

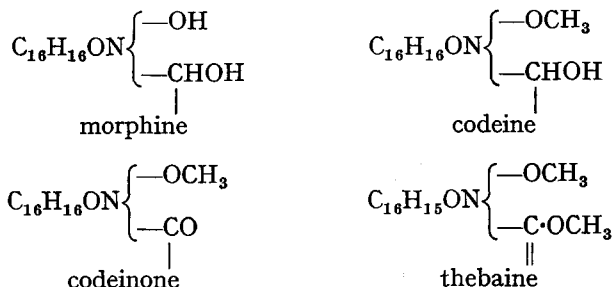

So far, we have accounted for the functional nature of two of the oxygen atoms; the unreactivity of the third oxygen atom suggests that it is probably of the ether type (Vongerichten, 1881).

All three alkaloids are tertiary bases (each combines with one molecule of methyl iodide to form a methiodide). When heated with hydrochloric acid at  $140^\circ$  under pressure morphine loses one molecule of water to form *apomorphine*,  $\text{C}_{17}\text{H}_{17}\text{O}_2\text{N}$ . Codeine, under the same conditions, also gives apomorphine (and some other products). Thebaine, however, when heated with dilute hydrochloric acid, forms *thebenine*,  $\text{C}_{18}\text{H}_{19}\text{O}_3\text{N}$  (a secondary base), and with concentrated hydrochloric acid, morphothebaine,  $\text{C}_{18}\text{H}_{19}\text{O}_3\text{N}$  (a tertiary base). Thus in the formation of thebenine from thebaine, a tertiary nitrogen atom is converted into a secondary one. For this change to occur, the tertiary nitrogen must be of the type  $>\text{N}\cdot\text{R}$ , where the nitrogen is in a ring system; had the nitrogen been in the group  $\text{—NR}_2$ , then the formation of a *primary* base could be expected.

When morphine is distilled with zinc dust, phenanthrene and a number of bases are produced (Vongerichten *et al.*, 1869). This suggests that a phenanthrene nucleus is probably present, and this has been confirmed as follows. When codeine methiodide, I, is boiled with sodium hydroxide solution,  $\alpha$ -methylmorphimethine, II, is obtained and this, on heating with acetic anhydride, forms methylmorphol, III, and ethanoldimethylamine, IV (some of II isomerises to  $\beta$ -methylmorphimethine).

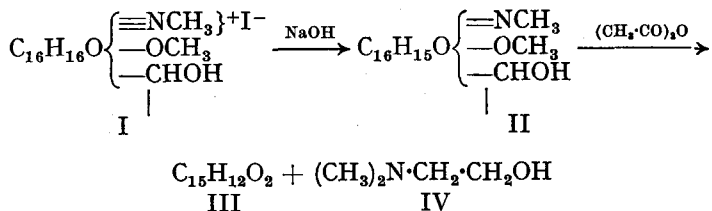

The structure of methylmorphol (III) was ascertained by heating it with hydrochloric acid at  $180^\circ$  under pressure; methyl chloride and a dihydroxyphenanthrene, *morphol*, were obtained. Oxidation of diacetylmorphol gives a diacetylphenanthraquinone; thus positions 9 and 10 are free. On further oxidation (permanganate), the quinone is converted into phthalic acid; therefore the two hydroxyl groups are in the same ring. Since the fusion of morphine with alkali gives protocatechuic acid, this shows that both

hydroxyl groups in morphol are in the *ortho*-position. Finally, Pschorr *et al.* (1900) showed by synthesis that dimethylmorphol is 3:4-dimethoxyphenanthrene (*cf.* Pschorr synthesis, §2 *via.* X).

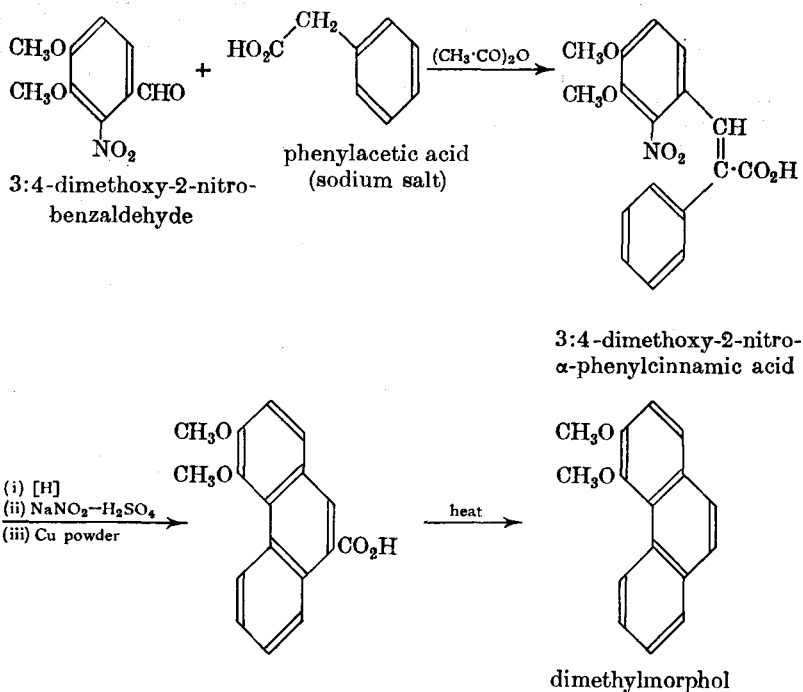

Then Pschorr *et al.* (1902) synthesised methylmorphol (III), and showed it to be 4-hydroxy-3-methoxyphenanthrene (in this synthesis Pschorr used 3-acetoxy-4-methoxy-2-nitrobenzaldehyde).

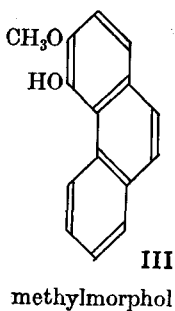

The formation of ethanoldimethylamine (IV) from  $\alpha$ -methylmorphimethine indicates that there is a  $>NCH_3$  group in codeine (only *one* methyl iodide molecule adds to codeine to form codeine methiodide; it has also been shown above that this nitrogen is in a heterocyclic ring).

When  $\beta$ -methylmorphimethine is heated with water, the products obtained are trimethylamine, ethylene and *methylmorphenol* (Vongerichten, 1896). Demethylation of this compound with hydrochloric acid produces *morphenol*, a compound which contains one phenolic hydroxyl group and an inert

oxygen atom. On fusion with potassium hydroxide, morphenol gives 3 : 4 : 5-trihydroxyphenanthrene (Vongerichten *et al.*, 1906). The structure of this compound was shown by the synthesis of 3 : 4 : 5-trimethoxyphenanthrene, which was found to be identical with the product obtained by methylating the trihydroxyphenanthrene obtained from morphenol (Pschorr *et al.*, 1912). Furthermore, the reduction of morphenol with sodium and ethanol gives morphol (Vongerichten, 1898). These results can be explained by assuming that morphenol has a structure containing an ether linkage in positions 4 : 5 (of the phenanthrene nucleus).

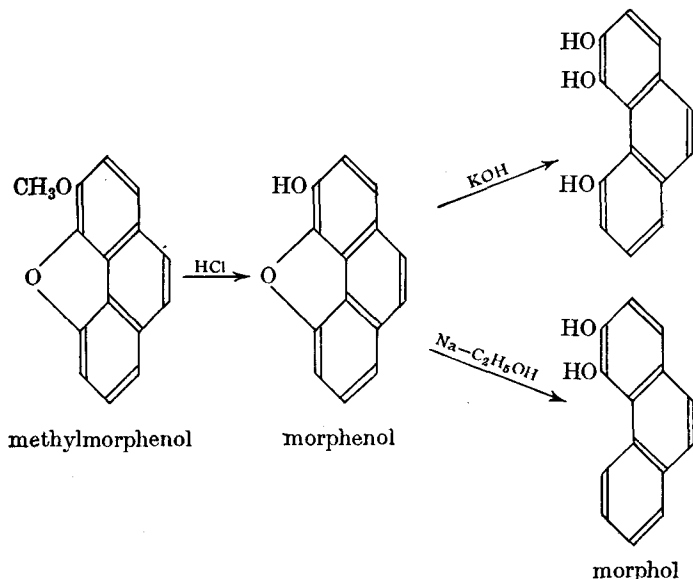

Codeinone, on heating with acetic anhydride, gives ethanolmethylamine and the diacetyl derivative of 4 : 6-dihydroxy-3-methoxyphenanthrene.

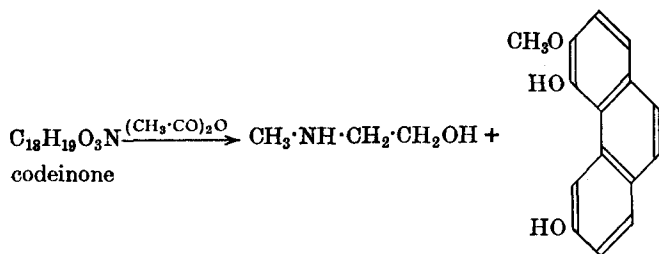

The position 3 of the methoxyl group and the position 4 of the hydroxy group have already been accounted for; the hydroxyl group in the 6-position must therefore be produced from the oxygen of the keto group in codeinone.

Based on the foregoing evidence, and a large amount of other experimental work, Gulland and Robinson (1923, 1925) have proposed the following structures.

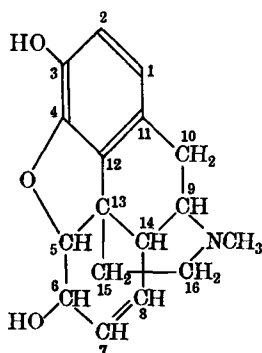

morphine

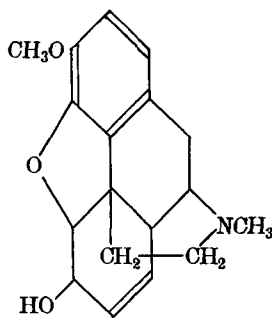

codeine

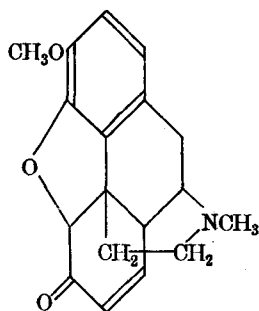
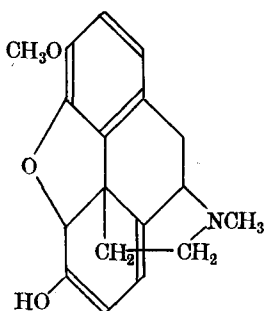
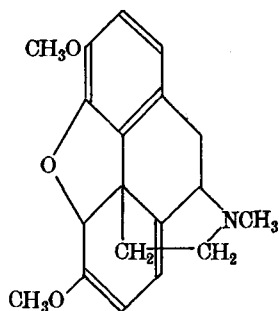
codeinone  
(keto form)codeinone  
(enol form)

thebaine

Gates *et al.* (1956) have now synthesised morphine.

**§28. Biosynthesis of alkaloids.** As more and more structures of alkaloids were elucidated, it became increasingly probable that the precursors in the biosynthesis of alkaloids were amino-acids and amino-aldehydes and amines derived from them. A particularly interesting point is that the consideration of biosynthesis has led to deductions in structure, *e.g.*, Woodward (1948) proposed a biosynthesis of strychnine, and from this Robinson (1948) deduced the structure of emetine which was later confirmed by the synthetic work of Battersby *et al.* (1950).

We have already seen (§18. XIII) how keto-acids may be converted into amino-acids, and *vice versa*. There are also enzymes which bring about the decarboxylation of amino-acids to amines and the decarboxylation of  $\alpha$ -keto-acids to aldehydes. Thus amino-acids, amines and amino-aldehydes, together with formaldehyde (or its equivalent) are believed to be the units involved in the biosynthesis of alkaloids. The general technique has been to administer labelled precursors to plants and to isolate the alkaloid after some time has elapsed for the growth of the plant.

The following examples of biosynthesis illustrate the principles outlined above. Alkaloids containing a benzene ring are believed to be products of the shikimic acid route (§18. XIII); the amino-acids phenylalanine and tyrosine are the starting points for the biosynthesis of, *e.g.*, ephedrine, hordenine, mezcaine, etc. As an example, we may describe the biosynthesis of adrenaline (§12) from tyrosine; the route is possibly:

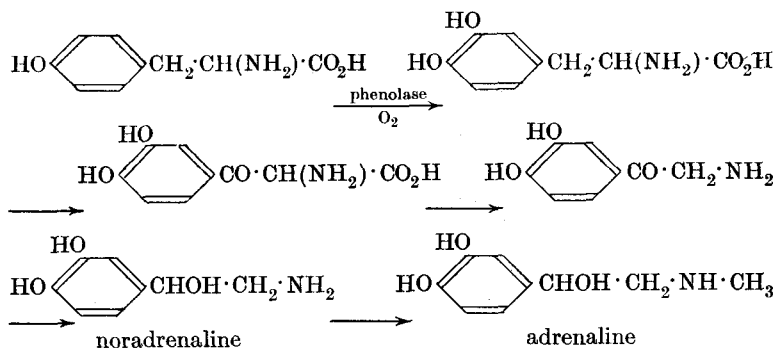

Leete *et al.* (1952-) have shown, using labelled compounds, that phenylalanine, tyrosine and 3,4-dihydroxyphenylalanine are precursors for the alkaloids of the phenylalanine and *isoquinoline* groups (see also later).

A study of the formulæ of hygrine (§13) and cuscohygrine (§13a) shows that the two most reasonable units are acetone and pyrrolidine. The biosynthesis of acetone occurs *via* acetoacetic acid (see §32a. VIII), but the precursor of the pyrrolidine fragment is less certain. The most likely amino-acid precursor appears to be ornithine, which could undergo the following reactions to give 4-methylaminobutanal (see also later):

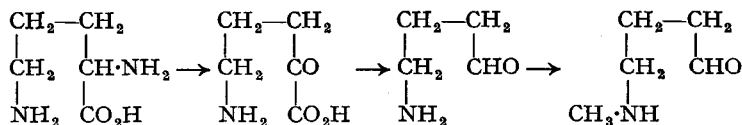

This compound may then be imagined to condense with acetone (or acetoacetic acid) to form hygrine and cuscohygrine (*cf.* §§13, 13a).

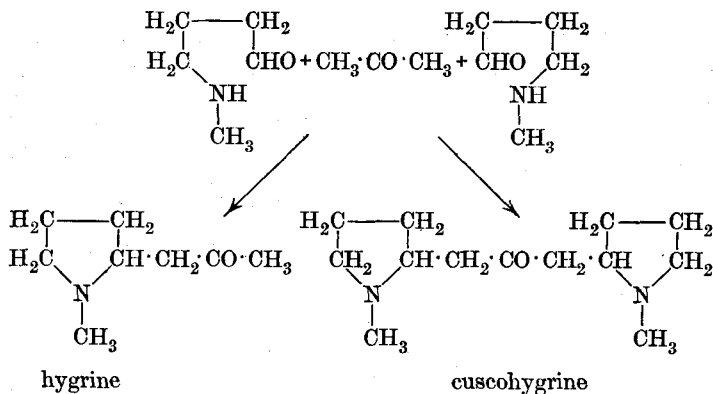

In the same way, the pelletierine group of alkaloids (§19) may all be imagined to be formed from 5-aminopentanal, *e.g.*, Anet *et al.* (1949) have condensed this aldehyde with acetoacetic acid at pH 11 to give *isopelletierine*; and 5-methylaminopentanal with acetoacetic acid at pH 7 to give *methylisopelletierine*. The amino-acid precursor of 5-aminopentanal is most likely lysine (the homologue of ornithine). It should also be noted that conversion of the keto group in *isopelletierine* into a methylene group gives *coniine*:



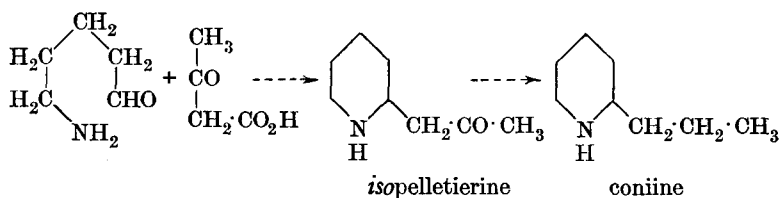

Now let us consider tropinone. Since this compound contains the hygrine skeleton, one possible mode of biosynthesis of tropinone could be *via* hygrine as the precursor:

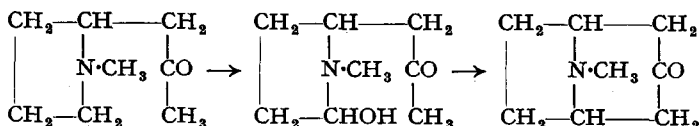

On the other hand, tropinone has been synthesised from succinaldehyde, methylamine and acetonedicarboxylic acid under physiological conditions (§22). In this case, the problem is the nature of the precursor of succinaldehyde. Glutamic acid is one possibility, and succinic acid is another. The biosynthesis of cocaine (§23) is similar to that of tropinone.

The biosynthesis of some alkaloids containing a piperidine ring has already been discussed. Mannich (1942) has suggested that arecoline (§17) is formed as follows:

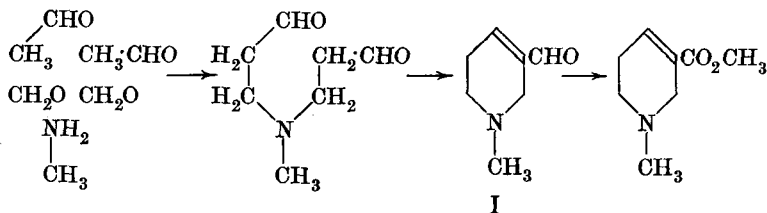

Mannich obtained I by carrying out the condensation with a mixture of acetaldehyde, formaldehyde and methylamine at room temperature at pH 3.

Leete (1955-1958) has shown, using labelled ornithine, that this amino-acid is a good precursor for the pyrrolidine ring in nicotine, and has also suggested that putrescine, glutamic acid and proline are incorporated into the pyrrolidine ring, but are less efficient precursors than ornithine. Marion *et al.* (1954) have also shown that labelled ornithine is incorporated into hyoscyamine (§22). Kaczkowski *et al.* (1960), using labelled compounds, have found that acetate is incorporated into the tropane ring in hyoscyamine, possibly *via* acetoacetate. Leete (1960) has shown that phenylalanine is a precursor of tropic acid.

The origin of the pyridine ring is still obscure. Some suggestions have been described above. It appears that alanine and aspartic acid are precursors of nicotinic acid, and experiments using tritium-labelled nicotinic acid support the hypothesis that it is converted into nicotine *via* a 6-pyridone derivative (Dawson *et al.*, 1958).

It has been pointed out above that phenylalanine, etc. are precursors for the isoquinoline alkaloids. Thus, *e.g.*, papaverine (§26) might possibly undergo biosynthesis as follows:

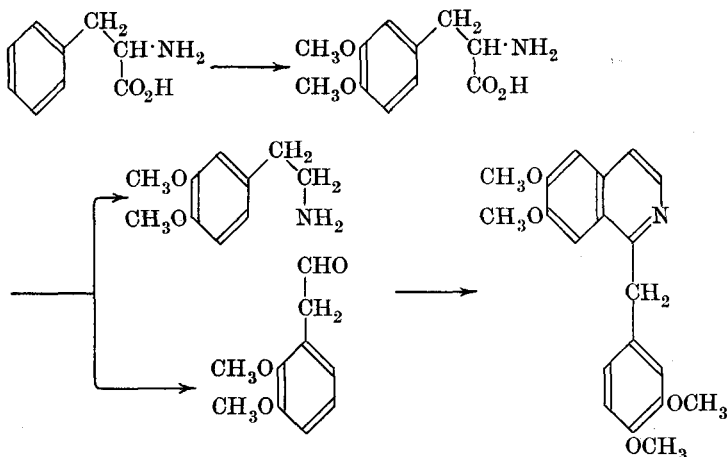

Support for the plausibility of this mechanism is given, *e.g.*, by the formation of the tetrahydroisoquinoline from the condensation between 3 : 4-dihydroxyphenylethylamine and acetaldehyde at pH 3-5 (Schöpf *et al.*, 1934).

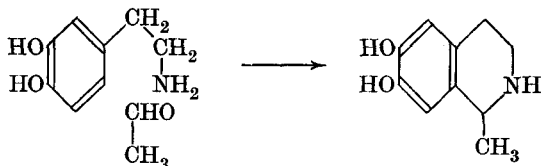

Rapoport *et al.* (1960), using labelled carbon dioxide ( $^{14}\text{C}$ ), have shown that the primary product of synthesis in the morphine alkaloids is apparently thebaine, which is later converted into codeine and morphine.

#### READING REFERENCES

- Henry, *The Plant Alkaloids*, Churchill (1949, 4th ed.).  
 Gilman (Ed.), *Advanced Organic Chemistry*, Wiley (1943, 2nd ed.). Vol. II. Ch. 15. Alkaloids.  
 Cook (Ed.), *Progress in Organic Chemistry*, Butterworth. Vol. I (1952). Ch. I. Molecular Structure of Strychnine, Brucine and Vomisine. Vol. III (1955). Ch. 5. Indole Alkaloids.  
 Manske and Holmes (Ed.), *The Alkaloids*, Academic Press. (Vol. I, 1950; —.)  
 Bergel and Morrison, Synthetic Analgesics, *Quart. Reviews (Chem. Soc.)*, 1948, **2**, 349.  
 Stern, Synthetic Approaches to the Morphine Structure, *Quart. Reviews (Chem. Soc.)*, 1951, **5**, 405.  
 Gates and Tschudi, The Synthesis of Morphine, *J. Amer. Chem. Soc.*, 1956, **78**, 1380.  
 McKenna, Steroidal Alkaloids, *Quart. Reviews (Chem. Soc.)*, 1953, **7**, 231.  
 Bentley, *The Chemistry of the Morphine Alkaloids*, Oxford Press (1954).  
 Bentley, *The Alkaloids*, Interscience Publishers (1957).  
 Glenn, The Structure of the Ergot Alkaloids, *Quart. Reviews (Chem. Soc.)*, 1954, **8**, 192.  
 Saxton, The Indole Alkaloids Excluding Harmine and Strychnine, *Quart. Reviews (Chem. Soc.)*, 1956, **10**, 108.  
 Sir Robert Robinson, *The Structural Relations of Natural Products*, Oxford Press (1955).  
 Morgan and Barltrop, Veratrum Alkaloids, *Quart. Reviews (Chem. Soc.)*, 1958, **12**, 34.  
 Rodd (Ed.), *Chemistry of the Carbon Compounds*, Elsevier. Vol. IVC (1960). Alkaloids, Chh. XXIII-XXIX.  
 Sangster, Determination of Alkaloid Structures, *J. Chem. Educ.*, 1960, **37**, 454, 518.  
 Battersby, Alkaloid Biosynthesis, *Quart. Reviews (Chem. Soc.)*, 1961, **15**, 259.  
 Huisgen, Richard Willstätter, *J. Chem. Educ.*, 1961, **38**, 259.  
 Ray, Alkaloids—the World's Pain Killers, *J. Chem. Educ.*, 1960, **37**, 451.

CHAPTER XV  
ANTHOCYANINS

**§1. Introduction.** Anthocyanins are natural plant pigments; they are glycosides and their aglycons, *i.e.*, the sugar-free pigments, are known as the *anthocyanidins*. The anthocyanins, which are water-soluble pigments, generally occur in the aqueous cell-sap, and are responsible for the large variety of colours in flowers; red—violet—blue. Willstätter *et al.* (1913– ) showed that the various shades of colour exhibited by all flowers are due to a very small number of different compounds. Furthermore, these different compounds were shown to contain the same carbon skeleton, and differed only in the nature of the substituent groups. The anthocyanin pigments are amphoteric; their acid salts are usually red, their metallic salts usually blue and in neutral solution the anthocyanins are violet (see also §5).

**§2. General nature of the anthocyanins.** The fundamental nucleus in anthocyanidins is benzopyrylium chloride, but the parent compound is 2-phenylbenzopyrylium chloride or **flavylium chloride**. (The formulæ are now usually written with the oxygen atom at the top, *i.e.*, the formulæ

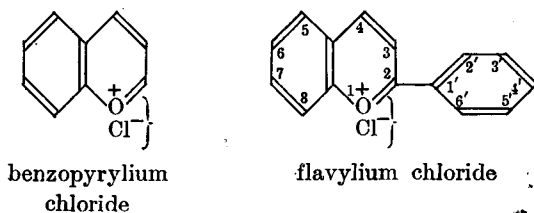

shown are turned upside down; there is no change in numbering.) All anthocyanidins are derivatives of 3 : 5 : 7-trihydroxyflavylium chloride. The following table on page 546 shows some common anthocyanidins (as chlorides).

Various sugars have been found in anthocyanins; the most common are glucose, galactose and rhamnose, and the most important of these is glucose, which occurs as the diglucoside. Some pigments, as well as being glycosides, are also acylated derivatives, two common acids being *p*-hydroxybenzoic acid and malonic acid. The acid radical may be attached either to a phenolic hydroxyl group in the flavylium nucleus or to a hydroxyl group in the sugar residue.

A number of qualitative tests have been introduced to identify the various anthocyanins without actually isolating them (Robinson *et al.*, 1931–1933, 1938); *e.g.*,

(i) The pigment is extracted with amyl (pentyl) alcohol in the presence of sodium acetate containing a trace of ferric chloride; cyanidin gives a blue colour, delphinidin a less intense blue colour, and the others still less colour or no colour at all.

(ii) A dilute sodium hydroxide solution of the pigment is shaken with air; delphinidin (and petunidin) is decolorised and the others are not.

(iii) More recently chromatographic analysis has been used to identify anthocyanins (see also §5).

(iv) The spectra of the anthocyanins in the region 5000–5500 Å are similar, but Geissman *et al.* (1953) have shown that the addition of aluminium chloride to solutions of certain anthocyanins shifts the absorption maximum. Only

Aglycon		Occurrence
Trivial name	Chemical name	
Pelargonidin .	3 : 4' : 5 : 7-Tetrahydroxyflavylium chloride	Present in orange-red to scarlet flowers, <i>e.g.</i> , scarlet <i>Pelargonium</i> , orange-red dahlia.
Cyanidin . .	3 : 3' : 4' : 5 : 7-Pentahydroxyflavylium chloride	Present in crimson to bluish-red flowers, <i>e.g.</i> , deep red dahlia, red roses, blue cornflower.
Delphinidin .	3 : 3' : 4 : 5 : 5' : 7-Hexahydroxyflavylium chloride	Present in violet to blue flowers, <i>e.g.</i> , Delphinium.
Peonidin . .	3 : 4' : 5 : 7-Tetrahydroxy-3'-methoxyflavylium chloride	Present in flowers less blue than the Cyanidin group, <i>e.g.</i> , red peony.
Malvidin (Syringidin)	3 : 4' : 5 : 7-Tetrahydroxy-3' : 5'-dimethoxyflavylium chloride	Present in flowers less blue than the Delphinidin group, <i>e.g.</i> , <i>Primula viscosa</i> .
Hirsutidin . .	3 : 4' : 5-Trihydroxy-3' : 5' : 7-trimethoxyflavylium chloride	Present in <i>Primula hirsuta</i> .

anthocyanins with the 3' : 4'-dihydroxyl groups *free* show this shift, and so this observation may offer a method for analysing anthocyanin mixtures.

**§3. Structure of the anthocyanidins.** The anthocyanin is first hydrolysed with hydrochloric acid and the anthocyanidin is then isolated as the chloride. The usual analytical methods are applied to determine the number of hydroxyl and methoxyl groups present in the molecule. The structure of the anthocyanidin is ascertained by the nature of the products obtained by fusing the anthocyanidin with potassium hydroxide (Willstätter *et al.*, 1915); phloroglucinol or a methylated phloroglucinol and a phenolic acid are always obtained, *e.g.*, cyanidin chloride gives phloroglucinol and protocatechuic acid.

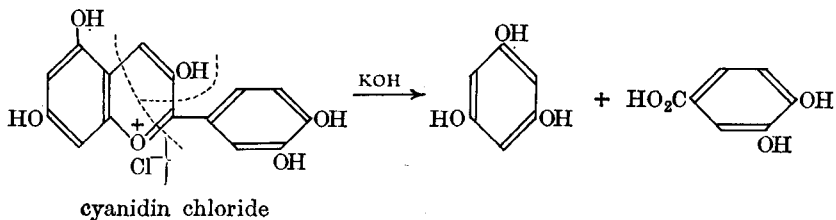

This method suffers from the disadvantage that the fusion (or boiling with concentrated potassium hydroxide solution) not only degrades the anthocyanidin, but also often demethylates it at the same time. Thus the positions of the methoxyl groups in the original compound are now rendered uncertain. This difficulty was overcome by Karrer *et al.* (1927), who degraded the anthocyanidin with a 10 per cent. solution of barium hydroxide or sodium hydroxide in an atmosphere of hydrogen; in this way, the methoxyl groups are left intact.

The next problem is to ascertain the positions of the sugar residues.

(i) Karrer *et al.* (1927) methylated the anthocyanin, then removed the sugar residues by hydrolysis (hydrochloric acid), and finally hydrolysed with barium hydroxide solution in an atmosphere of hydrogen; the positions of the *free* hydroxyl indicate the points of attachment of the sugar residues. In some cases, however, interpretation of the results is uncertain, *e.g.* (G represents a sugar residue):

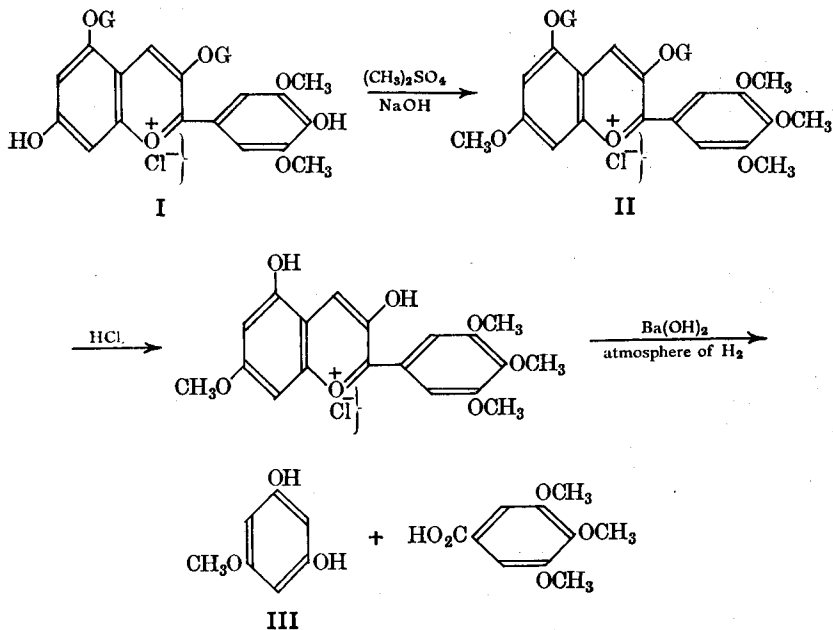

The problem is: Which of the two hydroxyl groups in monomethylphloroglucinol was originally attached to G? The above results do not lead to a definite answer, since had the structure of the anthocyanin been IV instead of I, III would still have been obtained:

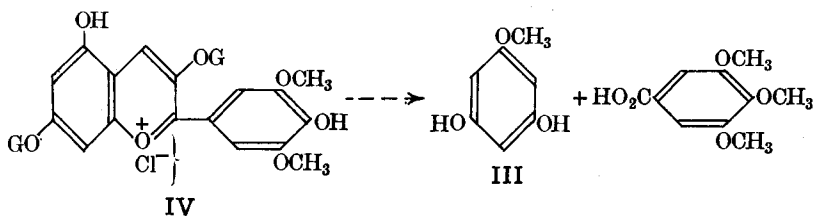

(ii) Hydrogen peroxide (15 per cent.) attacks anthocyanins as follows (Karrer *et al.*, 1927):

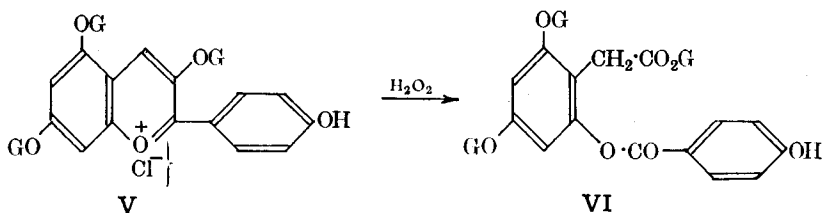

If the anthocyanin, V, has a glucose residue in the 3-position, then *this* glucose residue in VI is readily hydrolysed by dilute ammonia. If the glucose residue in V is in either the 5- or 7-position, then this glucose residue in VI is removed only by heating with dilute hydrochloric acid. Thus position 3 can be distinguished from positions 5 or 7, but the latter two cannot be distinguished from each other.

(iii) Anthocyanins with a free hydroxyl group in the 3-position are very readily oxidised by ferric chloride; the anthocyanins are rapidly decolorised in this oxidation (Robinson *et al.*, 1931).

Conclusive evidence for the positions of the sugar residues is afforded by the synthesis of the anthocyanins (see, *e.g.*, cyanin, §5). In general, it has been found that glucose residues are linked at positions 3 or 3:5.

#### §4. General methods of synthesising the anthocyanidins.

(i) Willstätter (1914) synthesised anthocyanidins starting from coumarin.

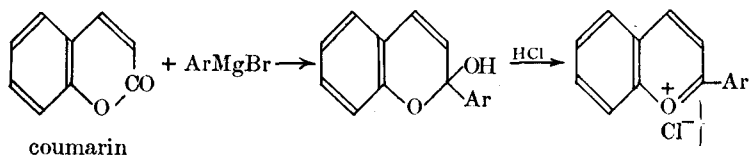

This method has very limited application.

(ii) Robinson has introduced a number of methods whereby *all* anthocyanidins can be prepared. The basic reaction of these methods is the condensation between *o*-hydroxybenzaldehyde and acetophenone in ethyl acetate solution which is then saturated with hydrogen chloride.

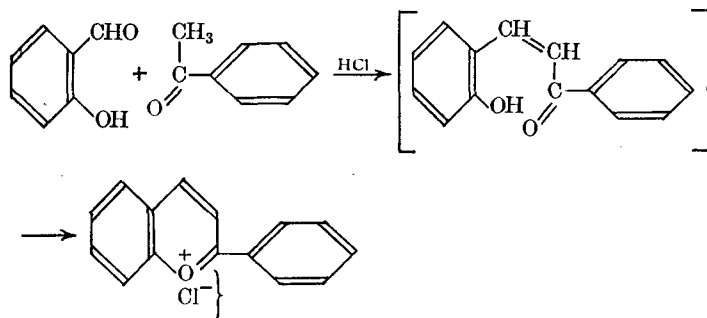

The original method of Robinson (1924) resulted in the formation of a product in which the substituent groups were either all hydroxyl groups or all methoxyl groups, *e.g.*,

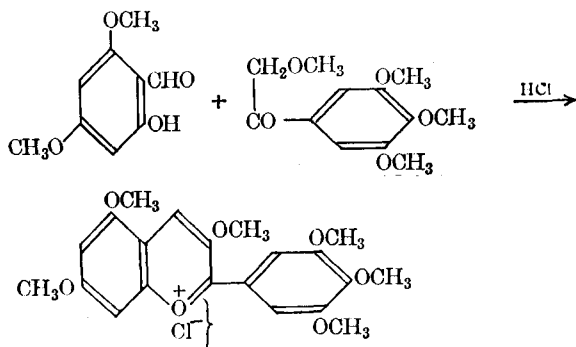

Robinson (1928, 1931) then modified this method so that the product could have both hydroxyl and methoxyl substituent groups, *e.g.*,

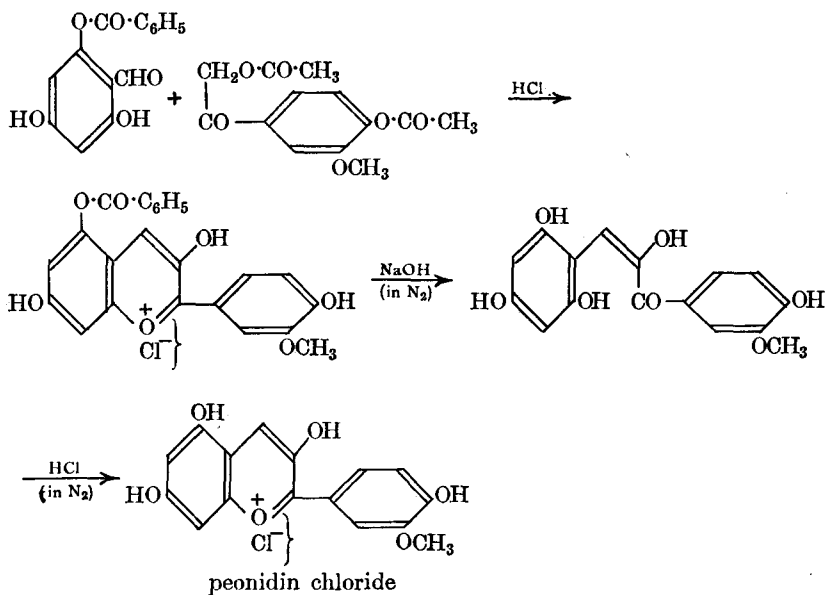

The following is a brief account of the methods used by Robinson and his co-workers for preparing the substituted acetophenones and substituted benzaldehydes.

#### $\omega$ : 3 : 4-Triacetoxyacetophenone.

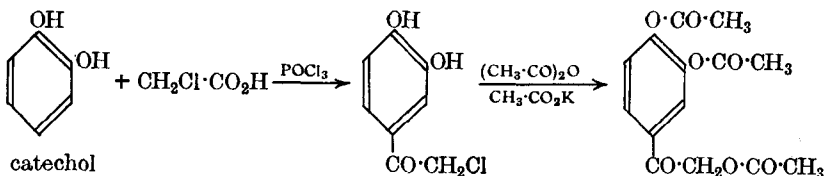

#### $\omega$ : 4-Diacetoxyacetophenone.

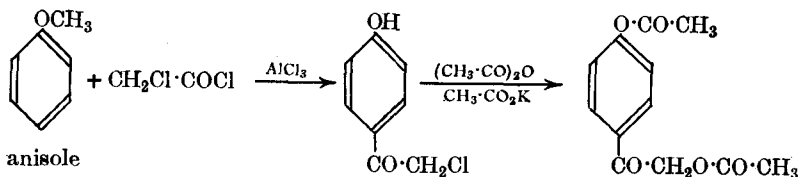

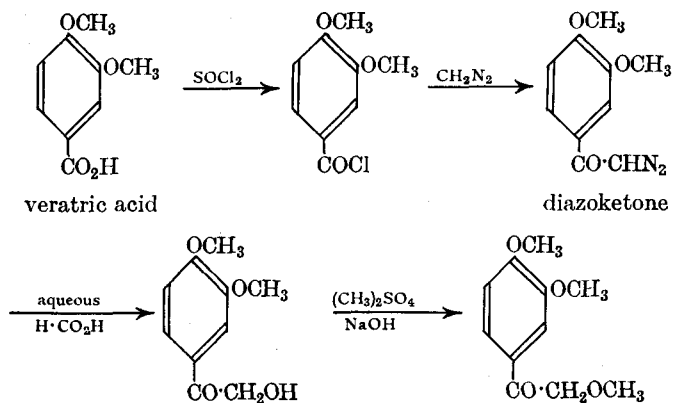
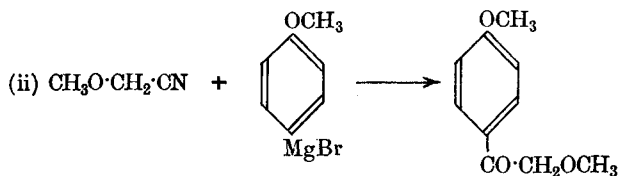
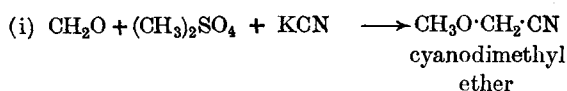
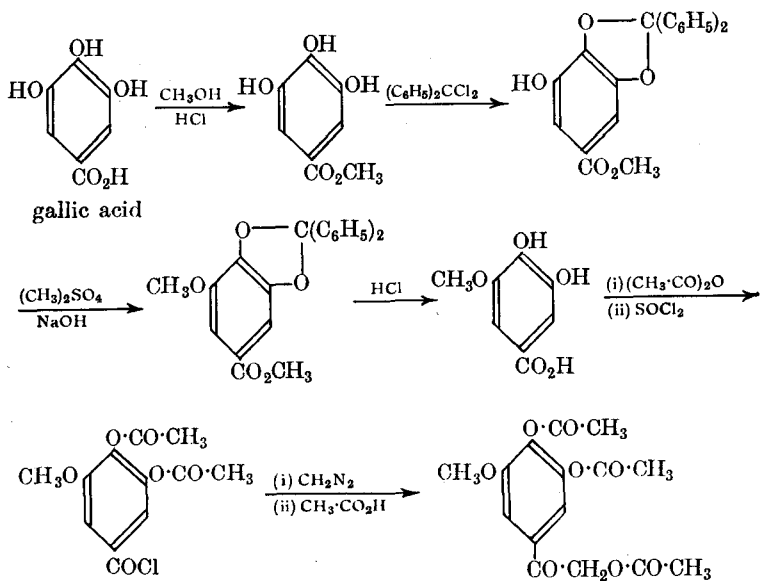
**ω : 3 : 4-Trimethoxyacetophenone.****ω : 4-Dimethoxyacetophenone.****ω : 3 : 4-Triacetoxy-5-methoxyacetophenone.**

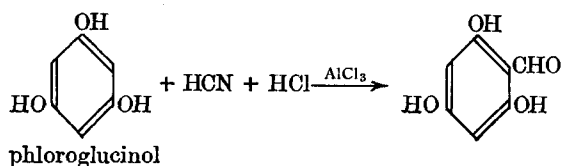
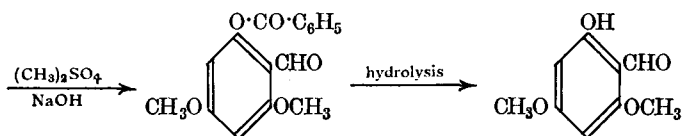
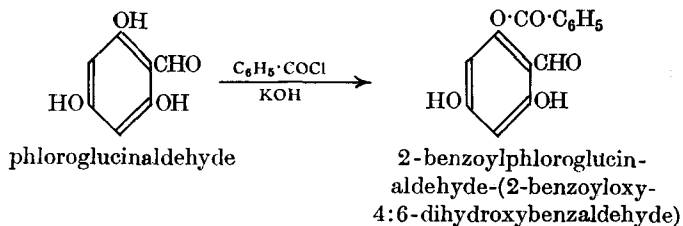

**2 : 4 : 6-Trihydroxybenzaldehyde (phloroglucinaldehyde).****2-Hydroxy-4 : 6-dimethoxybenzaldehyde.**

§5. **Cyanidin chloride**,  $\text{C}_{15}\text{H}_{11}\text{O}_6\text{Cl}$ . Cyanin chloride, on hydrolysis with hydrochloric acid, gives cyanidin chloride and two molecules of D-glucose.

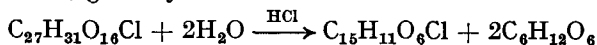

Since cyanidin chloride forms a penta-acetate, the molecule therefore contains five hydroxyl groups. No methoxyl groups are present, and so the potassium hydroxide fusion may be used to degrade this compound; this gives phloroglucinol and protocatechuic acid. Thus cyanidin chloride has the following structure:

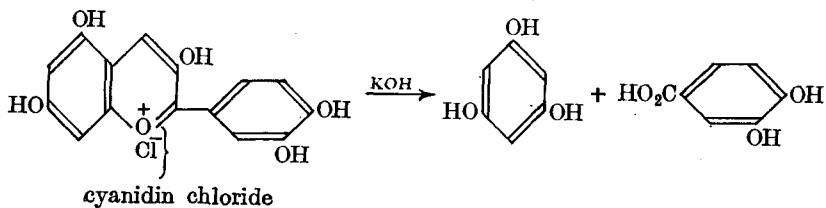

This structure has been confirmed by synthesis (Robinson *et al.*, 1928):

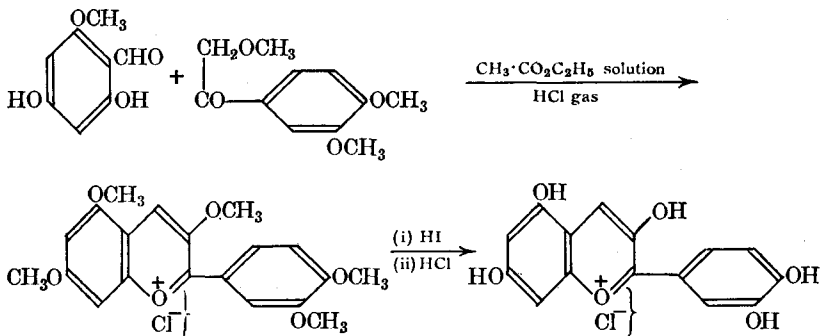

The formation of phloroglucinol and protocatechuic acid by the alkaline fusion of cyanidin chloride suggests a relationship to quercetin, since the latter also gives the same fusion products (see §14).

Cyanidin is insoluble in water, but is very soluble in ethanol. It is also soluble in aqueous sodium hydroxide, the solution being blue. The addition of hydrochloric acid changes the colour to purple when the solution is neutral, and when acid the solution becomes red. According to Everest (1914), the colours are due to the following structures (see also Ch. XXXI, Vol. I):

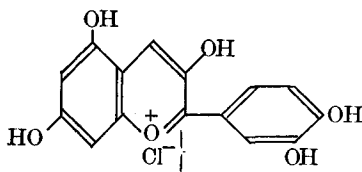

Oxonium salt  
Red in acid solution

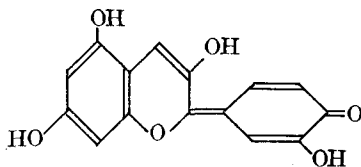

Colour base  
Purple in neutral solution

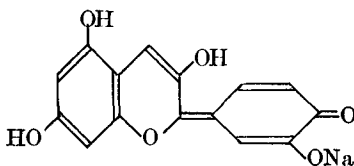

Salt of the colour base  
Blue in alkaline solution

Thus a variation of the  $pH$  will produce a variation in the range of colour.

On the basis of these ionic structures (positive for oxonium salts and negative for salts of the colour bases), anthocyanins should migrate in an electric field. Markakis (1960) has shown that various anthocyanins, when placed within an electric field applied across filter paper, move to the anode or cathode according to the  $pH$  of the solution. The method of paper electrophoresis may prove to be a very good means of separating, purifying, characterising and preparing anthocyanins.

Markakis also showed that isoelectric point (§4c. XIII) and the  $pH$  of minimum colour display coincide. On the acidic side of the isoelectric point, the oxonium salt-form predominates; and when the  $pH$  is higher than that of the isoelectric point, the salt of the colour base predominates. Sondheimer (1953) proposed that a pseudo-base of the structure shown is also possible (this is formed by the addition of a molecule of water to the colour

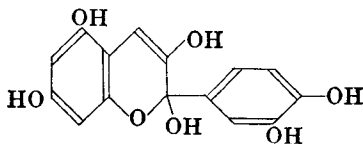

pseudo-base

base), and according to Markakis, it is this form which probably predominates at the isoelectric point. This structure has an interrupted conjugated bond system, and hence will be less coloured than the colour base itself.

**Cyanin** was the first anthocyanin to be isolated and its structure determined. It has been synthesised by Robinson *et al.* (1932). Phloroglucin-

aldehyde, I, is condensed with tetra-acetyl- $\alpha$ -bromoglucose, II (*cf.* §24. VII), in acetone solution to which has been added aqueous potassium hydroxide; the product is 2-*O*-monoacetyl- $\beta$ -glucosidylphloroglucinaldehyde, III. *o*-Hydroxy-3:4-diacetoxyacetophenone, IV, is also condensed with tetra-acetyl- $\alpha$ -bromoglucose (II) in benzene solution to give *o*-*O*-tetra-acetyl- $\beta$ -glucosidoxy-3:4-diacetoxyacetophenone, V. Compounds III and V are then dissolved in ethyl acetate and the solution saturated with hydrogen chloride; the product, VI, is treated first with cold aqueous potassium hydroxide and then with hydrochloric acid, whereby cyanin chloride, VII, is produced.

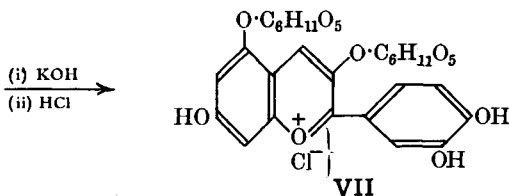
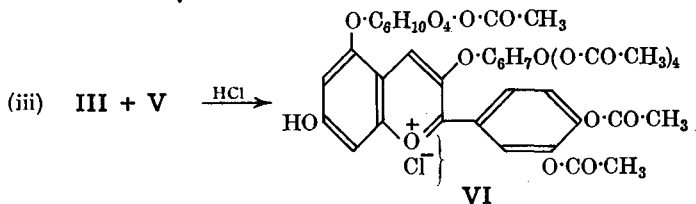
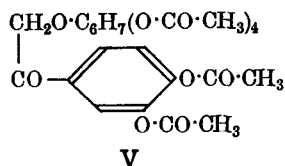
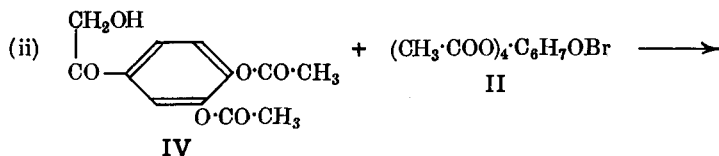
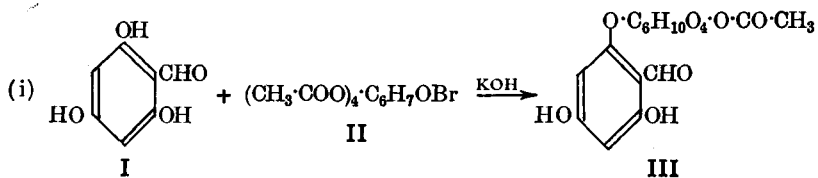

§6. **Pelargonidin chloride**,  $\text{C}_{15}\text{H}_{11}\text{O}_5\text{Cl}$ . This is formed, together with two molecules of glucose, when pelargonin chloride is hydrolysed with hydrochloric acid.

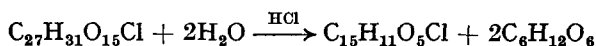

Since pelargonidin chloride forms a tetra-acetate, the molecule contains four hydroxyl groups. Furthermore, since there are no methoxyl groups

present, the potassium hydroxide fusion or boiling with concentrated potassium hydroxide solution may be used to degrade the compound; the products are phloroglucinol and *p*-hydroxybenzoic acid, and so the structure is probably as shown:

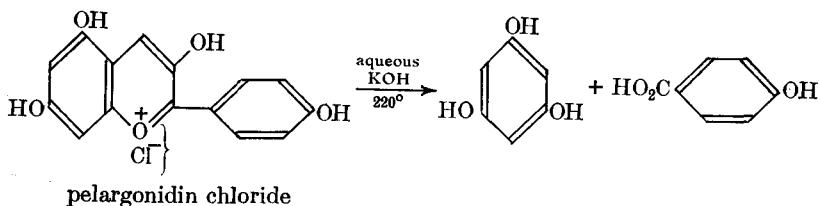

This structure has been confirmed by synthesis, *e.g.*, Robinson *et al.* (1928).

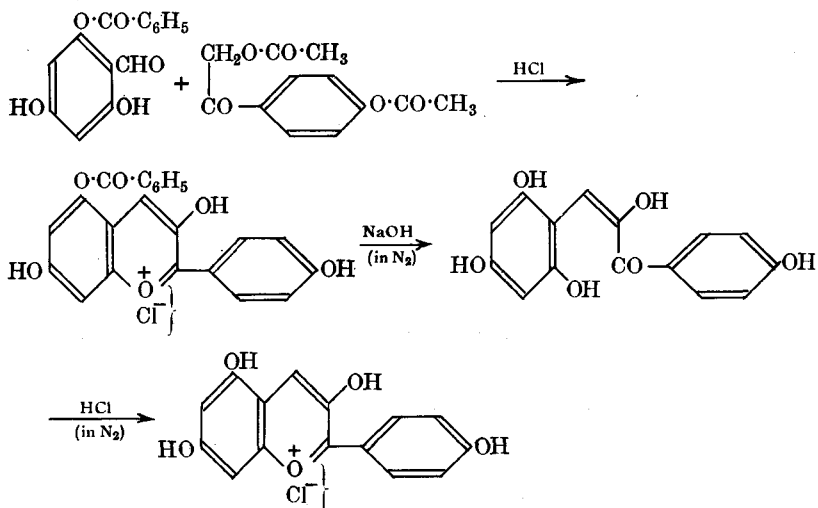

**Pelargonin chloride, I**, has been synthesised by Robinson *et al.* (1932) from 2-*O*-monoacetyl- $\beta$ -glucosidylphloroglucinaldehyde, II, and  $\omega$ -*O*-tetraacetyl- $\beta$ -glucosidoxy-4-acetoxyacetophenone, III (*cf.* cyanin chloride, §5).

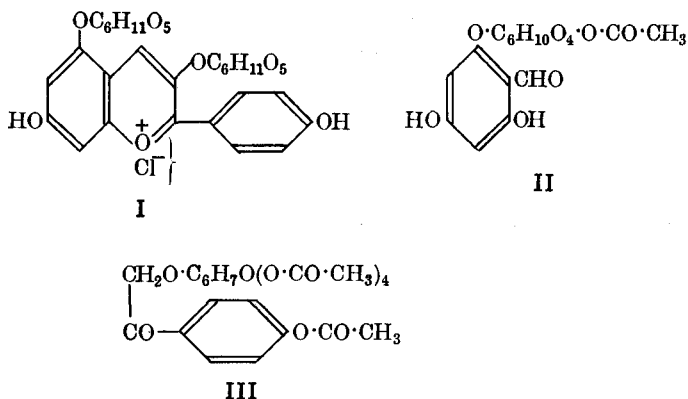

§7. **Delphinidin chloride**,  $C_{15}H_{11}O_7Cl$ , is obtained, together with two molecules of glucose and two molecules of *p*-hydroxybenzoic acid, when delphinidin chloride is hydrolysed with hydrochloric acid.

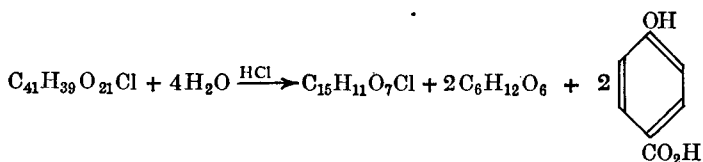

Delphinidin chloride contains six hydroxyl groups, and no methoxyl groups; on fusion with potassium hydroxide, the products are phloroglucinol and gallic acid.

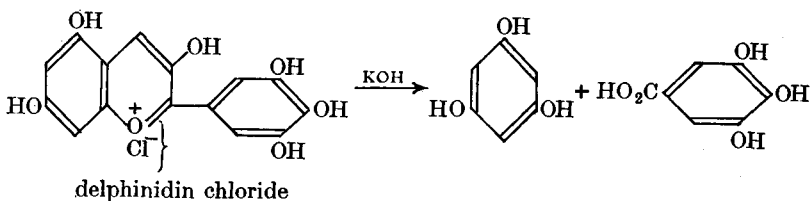

This structure has been confirmed by synthesis, starting from 2-benzoylphloroglucinaldehyde and  $\omega : 3 : 4 : 5$ -tetra-acetoxyacetophenone (Robinson *et al.*, 1930).

§8. **Peonidin chloride**,  $C_{16}H_{13}O_6Cl$ , is produced, together with two molecules of glucose, when peonidin chloride is hydrolysed with hydrochloric acid.

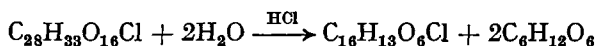

When heated with hydrogen iodide in the presence of phenol, peonidin chloride is demethylated to give cyanidin chloride. Thus peonidin is the monomethyl ether of cyanidin. Heating peonidin chloride with potassium hydroxide solution produces 4-hydroxy-3-methoxybenzoic acid and phloroglucinol. Thus:

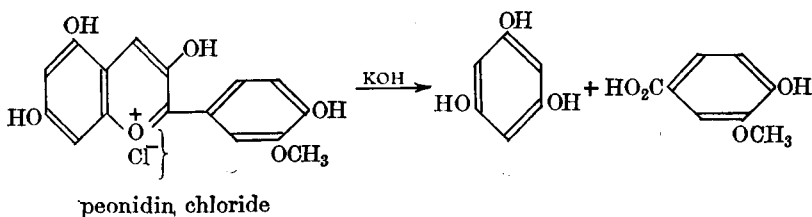

This structure has been confirmed by synthesis from 2-benzoylphloroglucinaldehyde and  $\omega : 4$ -diacetoxy-3-methoxyacetophenone (Robinson *et al.*, 1926).

**Peonin chloride**, I, has been synthesised by Robinson *et al.* (1931), using 2-*O*-tetra-acetyl- $\beta$ -glucosidylphloroglucinaldehyde, II, and  $\omega$ -tetra-acetyl- $\beta$ -glucosidoxy-4-acetoxy-3-methoxyacetophenone, III.

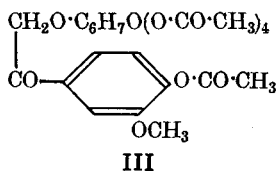
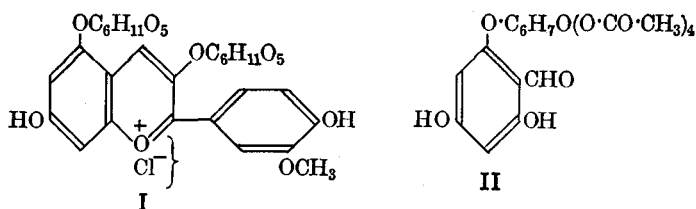

§9. **Malvidin chloride**,  $C_{17}H_{15}O_7Cl$ , is produced, together with two molecules of glucose, when malvin chloride is hydrolysed with hydrochloric acid.

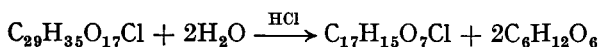

Malvidin chloride contains four hydroxyl groups and two methoxyl groups. When degraded by boiling barium hydroxide solution in an atmosphere of hydrogen, the products are phloroglucinol and *syringic acid* (4-hydroxy-3 : 5-dimethoxybenzoic acid). Thus:

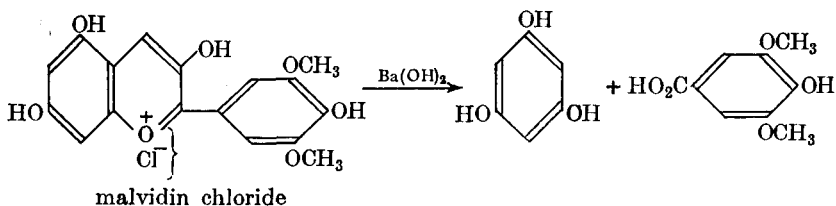

Robinson *et al.* (1928) confirmed this structure by synthesis, starting from 2-benzoylphloroglucinaldehyde and  $\omega$ -acetoxy-4-benzoyloxy-3 : 5-dimethoxyacetophenone (*cf.* §10). Robinson *et al.* (1932) have also synthesised **malvin chloride**, I, by condensing 2-*O*-tetra-acetyl- $\beta$ -glucosidylphloroglucinaldehyde with  $\omega$ -*O*-tetra-acetyl- $\beta$ -glucosidoxy-4-acetoxy-3 : 5-dimethoxyacetophenone, II.

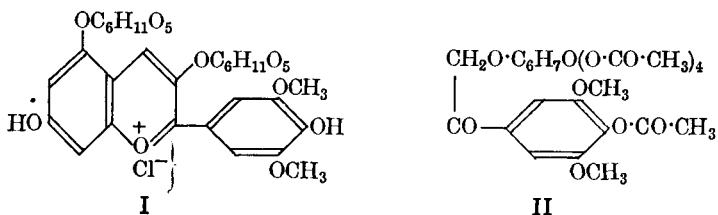

§10. **Hirsutidin chloride**,  $C_{18}H_{17}O_7Cl$ , is produced by the hydrolysis of hirsutin chloride with hydrochloric acid; two molecules of glucose are also produced.

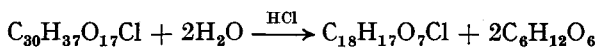

Hirsutidin chloride contains three hydroxyl groups and three methoxyl groups. Its structure is shown from the fact that on hydrolysis with barium

hydroxide solution in an atmosphere of hydrogen, the products are monomethylphloroglucinol and syringic acid. The formation of these products

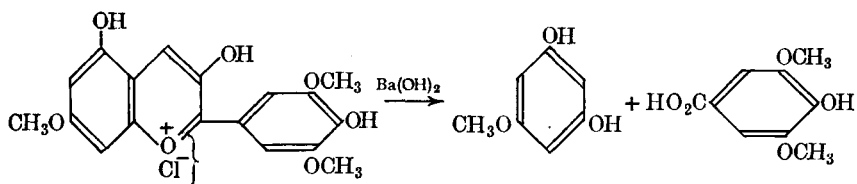

hirsutidin chloride

does not prove conclusively that the methoxyl group at position 7 is actually there; had this position been interchanged with the hydroxyl group at position 5, monomethylphloroglucinol would still have been obtained (*cf.* §3). The formula given for hirsutidin chloride, however, has been confirmed by synthesis, starting from 2-benzoyl-4-*O*-methylphloroglucinaldehyde and  $\omega$ -acetoxy-4-benzoyloxy-3 : 5-dimethoxyacetophenone (Robinson *et al.*, 1930).

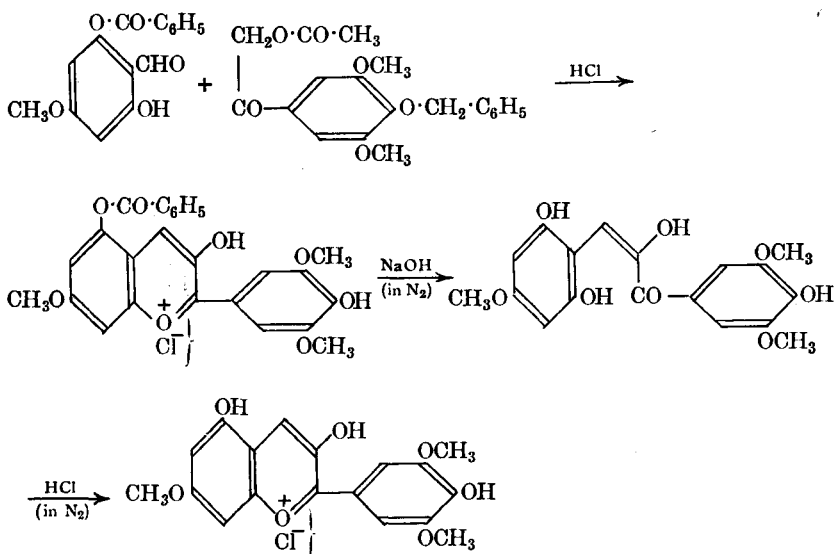

**Hirsutin chloride** has also been synthesised by Robinson *et al.* (1932) from 2-*O*-tetra-acetyl- $\beta$ -glucosidyl-4-*O*-methylphloroglucinaldehyde and  $\omega$ -*O*-tetra-acetyl- $\beta$ -glucosidoxy-4-acetoxy-3 : 5-dimethoxyacetophenone.

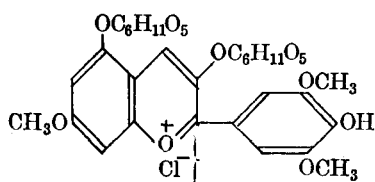

hirsutin chloride

## FLAVONES

§11. **Introduction.** The flavones, which are also known as the **antho-xanthins**, are yellow pigments which occur in the plant kingdom. Flavones

occur naturally in the free state, or as glycosides (the aglycon is the *anthoxanthidin* and the sugar is glucose or rhamnose), or associated with tannins. Chemically, the flavones are very closely related to the anthocyanins; the flavones are hydroxylated derivatives of *flavone* (2-phenyl-4-chromone) which may be partially alkylated. In almost all cases positions 5 and 7 are

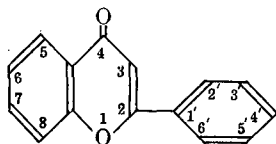

flavone

hydroxylated, and frequently one or more of positions 3', 4' and 5'. The general method of ascertaining the structure of the flavones is similar to that used for the anthocyanins: the number of free phenolic groups and the number of methoxyl groups are first determined, and then the products obtained by alkaline fusion or hydrolysis are examined. Finally, the structure is confirmed by synthesis. Recently, Simpson *et al.* (1954) have shown that methoxyflavones may be demethylated selectively by hydrobromic acid, the relative rates being  $3' > 4' > 7$ . These authors have also shown that the relative rates of methylation of flavone-hydroxyl groups with methyl sulphate and sodium hydrogen carbonate in acetone solution are  $7 > 4' > 3' > 3$ . With methyl sulphate and aqueous alcoholic sodium carbonate, the exact reverse of this order is obtained. These results thus offer a method of ascertaining the positions of methoxyl groups in various methoxyflavones.

§12. **Flavone**,  $C_{15}H_{10}O_2$ , occurs naturally as "dust" on flowers, leaves, etc. When boiled with concentrated potassium hydroxide solution, flavone, I, gives a mixture of four products, salicylic acid (III), acetophenone (IV), *o*-hydroxyacetophenone (V) and benzoic acid (VI). The products, which are produced in the pairs III and IV, and V and VI, arise from the fact that the opening of the pyrone ring produces *o*-hydroxydibenzoylmethane, II, which then undergoes scission in two different ways (II is a  $\beta$ -diketone).

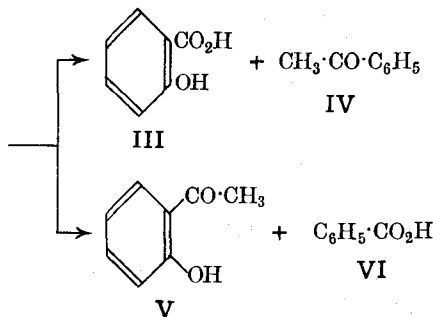
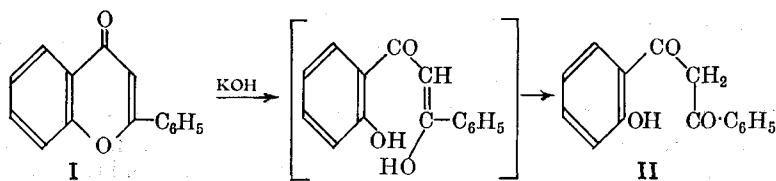



In general, all the flavones give a mixture of four products when degraded with potassium hydroxide. The intermediate *o*-hydroxy- $\beta$ -diketone can be isolated if cold alkali or an ethanolic solution of sodium ethoxide is used. On the other hand, if a normal solution of barium hydroxide is used as the degrading agent, then the products are usually salicylic acid and acetophenone (Simonis, 1917).

The structure given for flavone has been confirmed by synthesis. Many syntheses are known, e.g., the *Kostanecki synthesis* (1900). This is a general method for synthesising flavones, and consists in condensing the ester of an alkylated salicylic acid with an acetophenone in the presence of sodium (this is an example of the Claisen condensation; this synthesis is a reversal of the formation of III and IV). Thus, for flavone itself, the reaction is carried out with methyl *o*-methoxybenzoate and acetophenone.

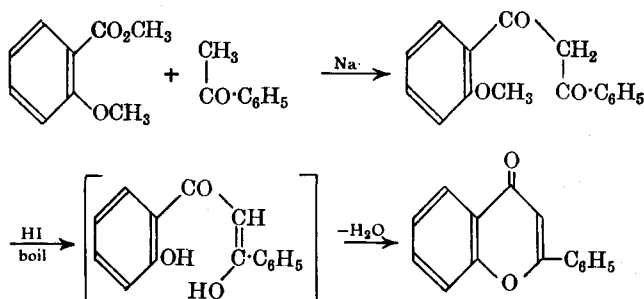

The most useful general synthetic method for preparing flavones is that of Robinson (1924). This is a reversal of the formation of V and VI; an *o*-hydroxyacetophenone is heated at about 180° with the anhydride and sodium salt of a substituted benzoic acid, e.g., flavone:

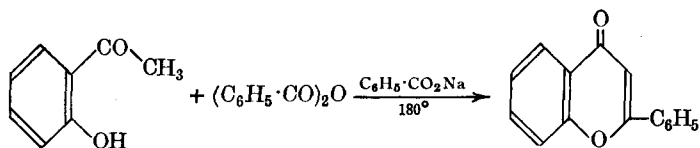

Another general method which is also a reversal of the formation of V and VI is illustrated by the preparation of *chrysin* (5 : 7-dihydroxyflavone) from 2 : 4 : 6-trimethoxyacetophenone and ethyl benzoate.

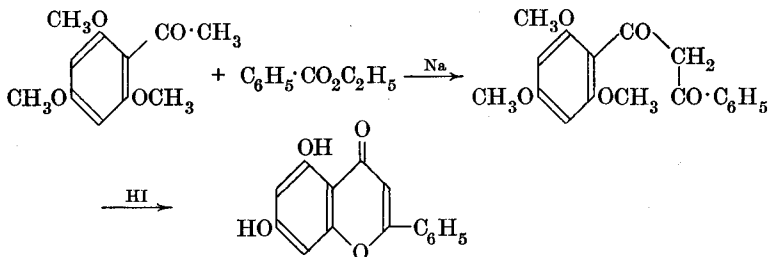

This preparation involves a Claisen condensation, and the following is also another general method which involves an "internal" Claisen condensation.

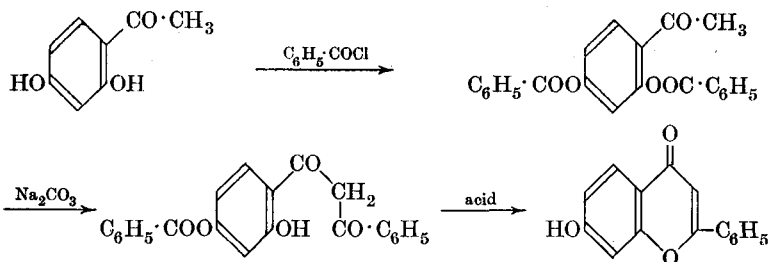

A recent method for synthesising flavones is by the ring expansion of 2-benzylidenecoumaran-3-ones (Wheeler *et al.*, 1955), *e.g.*,

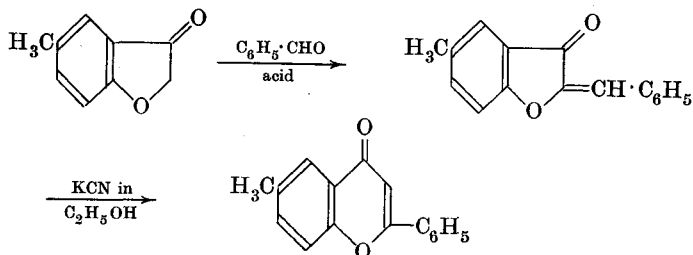

Most flavones are yellow solids which are soluble in water, ethanol and dilute acids and alkalis. The oxonium salts are usually more highly coloured than the free bases; the flavones do not occur naturally as salts (*cf.* anthocyanins). The structure of flavone salts is not certain; VII, VIII and IX are possibilities, and according to calculations of charge distribution (in  $\gamma$ -pyrone salts), IX appears to be most likely (Brown, 1951).

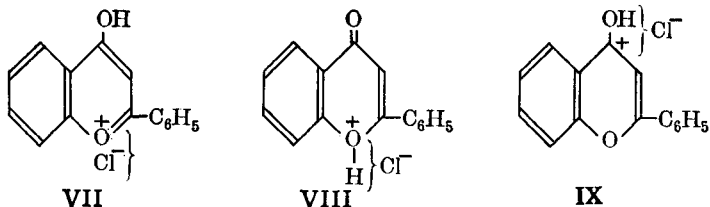

§13. **Flavonol** (3-hydroxyflavone),  $\text{C}_{15}\text{H}_{10}\text{O}_3$ . Flavonol is widely distributed in the plant kingdom, usually in the form of glycosides.

When boiled with an ethanolic solution of potassium hydroxide, flavonol gives *o*-hydroxybenzoyl-methanol and benzoic acid. This suggests that flavonol is 3-hydroxyflavone (3-hydroxy-2-phenyl- $\gamma$ -chromone).

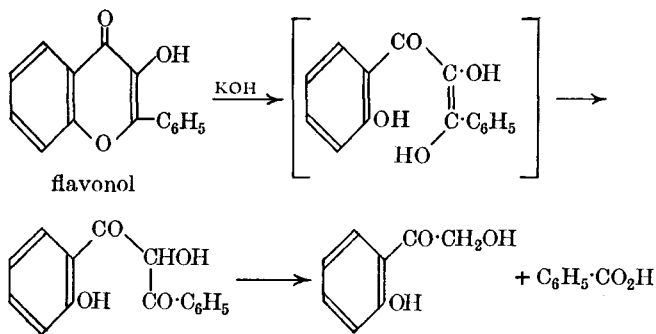

This structure has been confirmed by various syntheses, *e.g.*, Kostanecki *et al.* (1904). This is a general method, and uses the Claisen reaction between *o*-hydroxyacetophenones and substituted benzaldehydes, *e.g.*, flavonol.

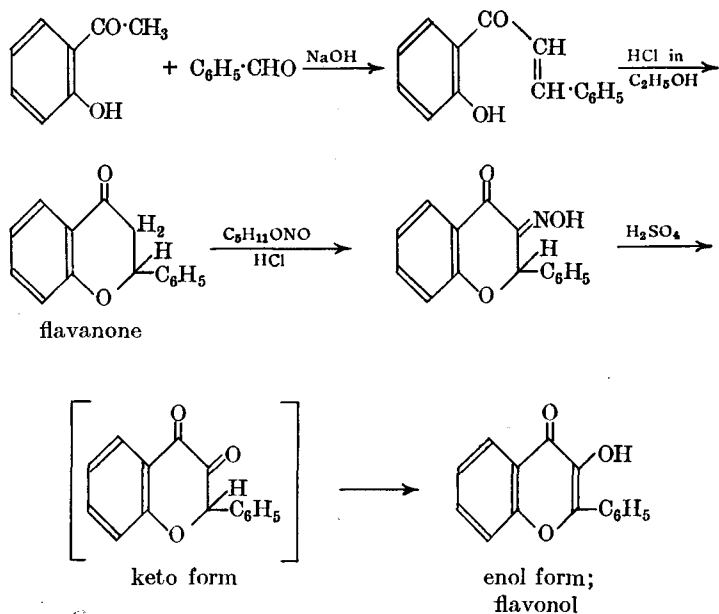

The synthesis, starting from flavanone, has been adapted to the preparation of flavones.

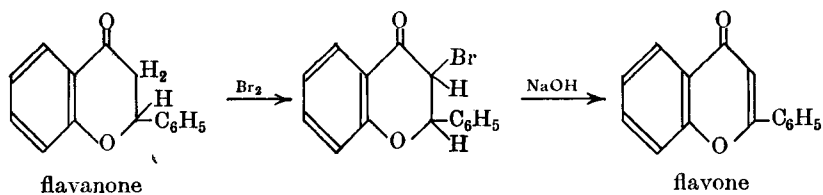

An alternative general method for preparing flavones based on the flavonol synthesis is as follows (Kostanecki *et al.*, 1898):

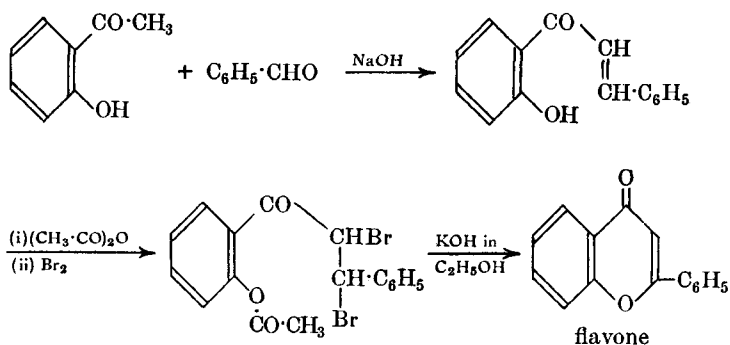

This synthesis has been simplified by Wheeler *et al.* (1955); these authors prepared flavones by condensing  $\omega$ -chloro-*o*-hydroxyacetophenones with aromatic aldehydes in the presence of ethanolic sodium hydroxide, *e.g.*,

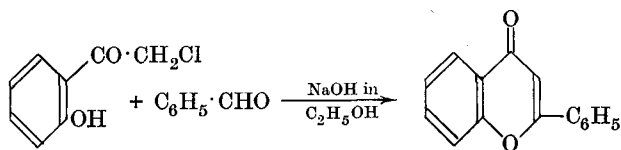

§14. **Quercetin**,  $C_{15}H_{10}O_7$ , occurs as the glycoside *quercitrin* in the bark of *Quercus tinctoria*; quercitrin appears to be the most widely distributed natural pigment. On hydrolysis with acids, quercitrin forms quercetin and one molecule of rhamnose.

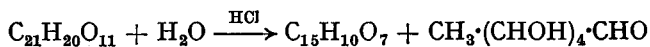

Quercetin contains five hydroxyl groups; no methoxyl groups are present; on fusion with potassium hydroxide, phloroglucinol and protocatechuic acid are obtained (*cf.* cyanidin, §5). Also, when quercetin is methylated and the product, pentamethylquercetin, boiled with an ethanolic solution of potassium hydroxide, 6-hydroxy- $\omega$ :2:4-trimethoxyacetophenone and veratric acid are obtained. These results suggest that quercetin is 3:3':4':5:7-pentahydroxyflavone.

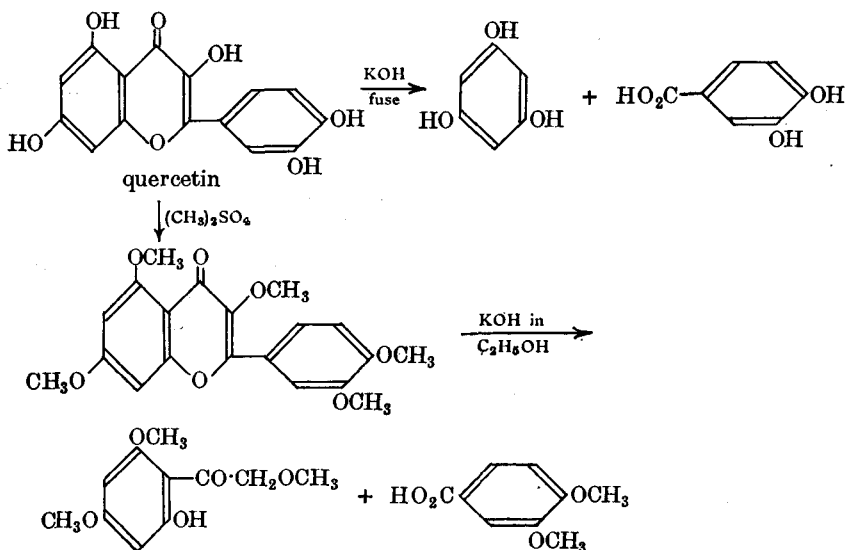

This structure has been confirmed by synthesis, *e.g.*, Kostanecki *et al.* (1904).

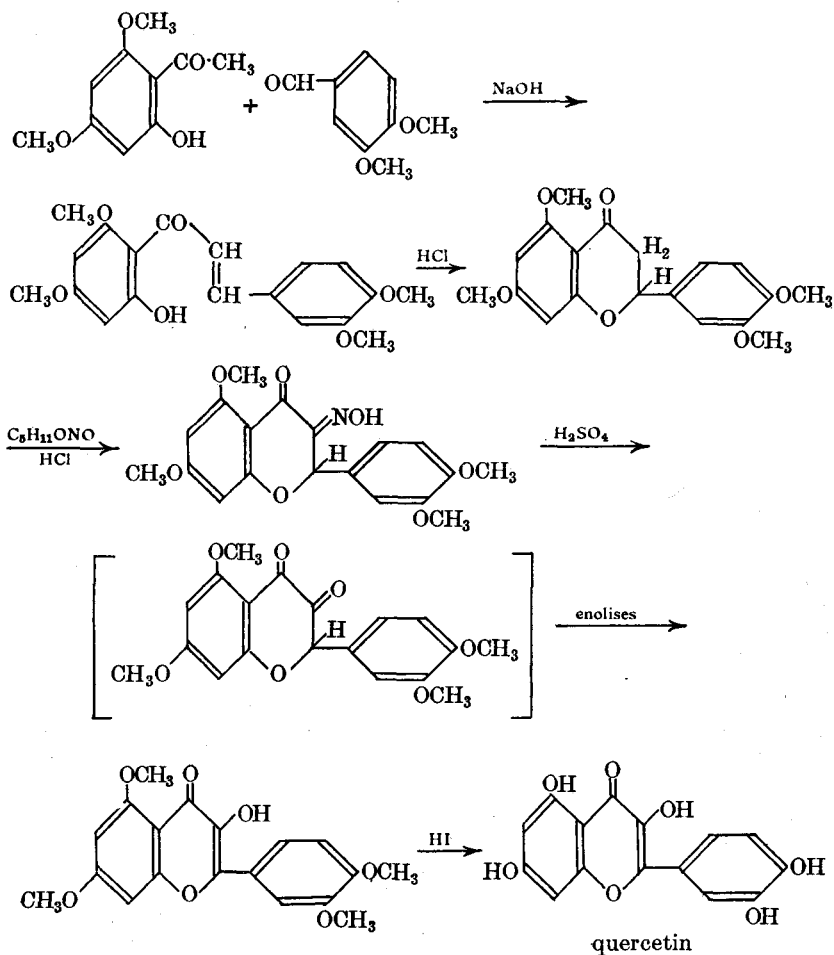

Another synthesis is that of Robinson *et al.* (1926); it is a general method for flavonols (*cf.* flavone, §12):  $\omega$ -methoxyphloroacetophenone is condensed with veratric anhydride in the presence of the potassium salt of veratric acid.

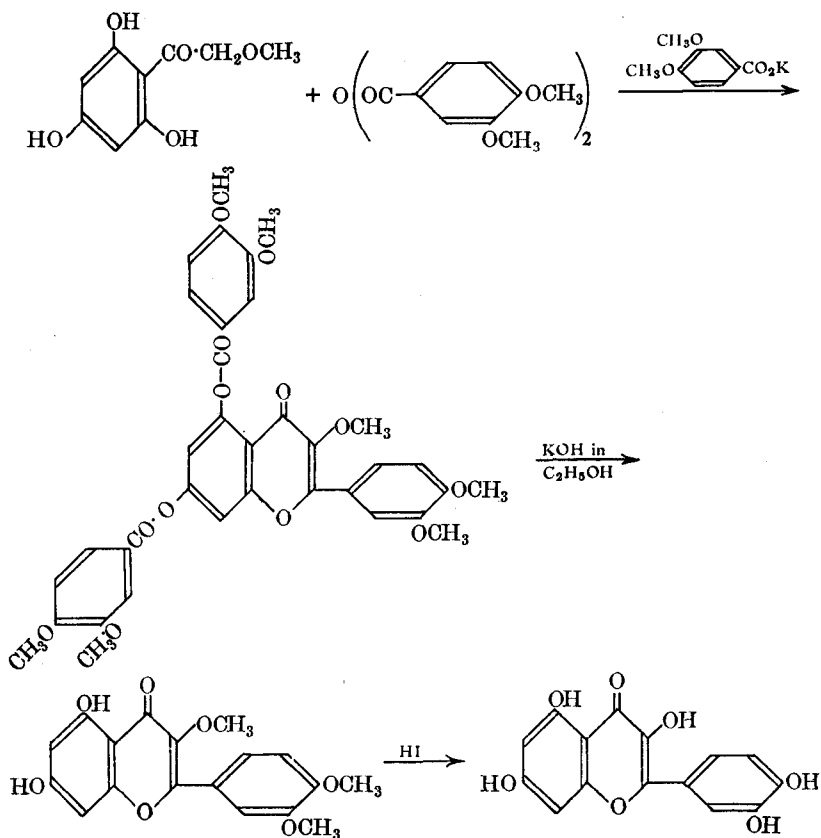

The position of the rhamnose residue in quercitrin has been shown to be 3 (Herzig *et al.*, 1912).

Before leaving this problem of quercetin, let us consider its relationship to cyanidin (§5). As we have seen, the relationship between the two compounds is suggested by the fact that both give the same products when fused with potassium hydroxide. Willstätter *et al.* (1914) reduced quercetin with magnesium in hydrochloric acid containing mercury, and thereby obtained a small amount of cyanidin chloride.

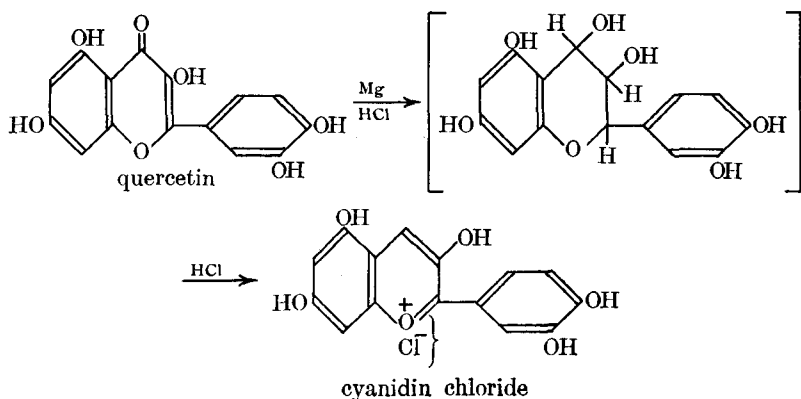

Bauer *et al.* (1954) have converted the penta-acetate of quercetin into cyanidin chloride by means of lithium aluminium hydride.

King *et al.* (1957) have shown that the reductive acetylation of a flavonol, followed by the action of hot hydrochloric acid, gives the corresponding anthocyanidin; thus:

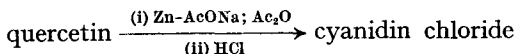

This appears to be a useful general method.

### ISOFLAVONES

§14a. *iso*Flavones are hydroxylated derivatives of *isoflavone* (3-phenyl-4-chromone) which may be partially alkylated. The *isoflavones* occur

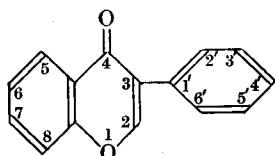

*isoflavone*

naturally, but are not so widespread as the flavones; they occur either in the free state or as glycosides. The general method of ascertaining the structure of *isoflavones* is similar to that used for the flavones (see §§3, 11). Thus fusion with potassium hydroxide breaks down the molecule into two fragments, and hydrolysis with ethanolic potassium hydroxide permits the isolation of intermediates. This may be illustrated with *daidzein* (Walz, 1931):

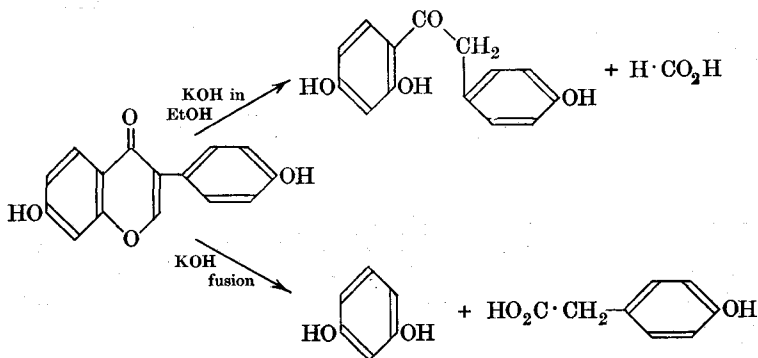

Oxidation with alkaline hydrogen peroxide may also be used in degrading *isoflavones*; recognisable fragments are not usually obtained by this method, but sometimes information may be obtained about the substituents in the 3-phenyl nucleus, *e.g.*, *genistein* (4':5':7-trihydroxyisoflavone) gives *p*-hydroxybenzoic acid.

The final proof of the structure of an *isoflavone* lies in its synthesis. A general method of synthesising *isoflavones* is that of Späth *et al.* (1930); *e.g.*, *isoflavone* itself may be synthesised from benzyl *o*-hydroxyphenyl ketone and ethyl formate:

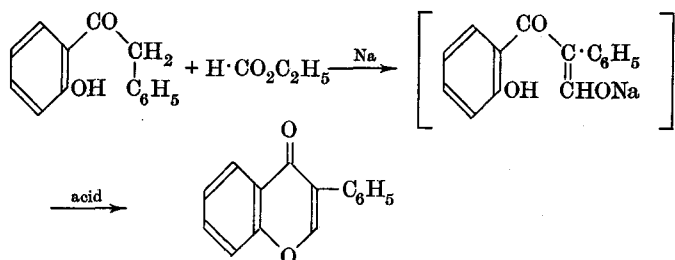

By using substituted ketones, various *isoflavones* may be synthesised, e.g., daidzein from 2 : 4-dihydroxyphenyl *p*-hydroxybenzyl ketone (Wessely *et al.*, 1933):

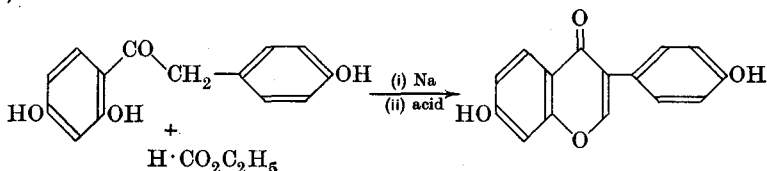

§14b. **Biosynthesis of the flavonoids.** Robinson (1936) considered the  $C_{15}$  skeleton of flavonoids to be composed of two parts,  $C_6$  and  $C_9$ :

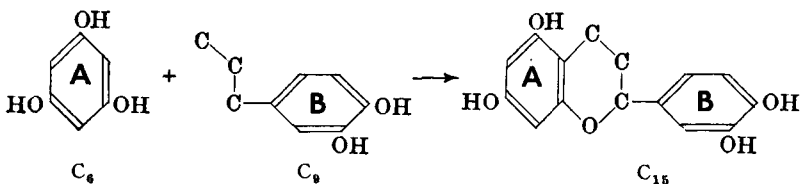

Biosynthetic work has shown that rings A and B are derived from different sources. Birch *et al.* (1955) have carried out the biosynthesis of benzenoid compounds from acetate, e.g., using cultures of *Penicillium griseofulvin*, it was shown that:



Underhill *et al.* (1957), using  $^{14}C$ -labelled compounds, showed that in the biosynthesis of quercetin and cyanidin, rings A and B have different origins; ring A appears to be produced from acetate, but ring B is produced by the shikimic acid pathway (§18. XIII). Biosynthetic studies of cyanidin (Weygand *et al.*, 1957; Grisebach, 1958) also support the origin of phloroglucinol (ring A) from acetate units.

### DEPSIDES

§15. **Depsides.** Phenolic acids, by the interaction of the carboxyl group of one molecule with the hydroxyl group of another, give rise to **depsides**:

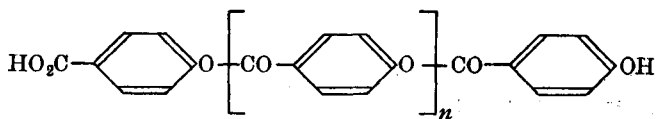



If  $n$  is zero, then the molecule is a didepside; if  $n$  is 1, then a tridepside; etc. The main sources of the depsides are the lichens.

In order to synthesise depsides in a known fashion, it is necessary to protect hydroxyl groups. Fischer (1919) carried this out by means of acetylation (acetic anhydride) or by introducing a carbomethoxyl group (with methyl chloroformate); two hydroxyl groups in the *ortho*-position may be protected by means of carbonyl chloride, *e.g.*, gallic acid forms the following compound.

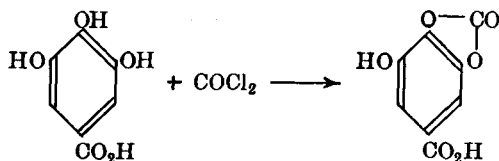

Let us consider the synthesis of a depside from a monohydroxybenzoic acid.

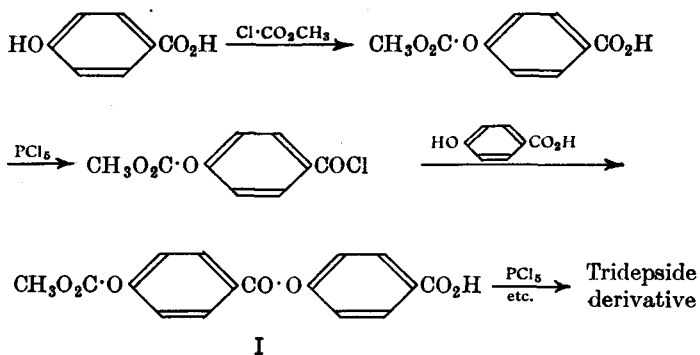

I may be hydrolysed to the didepside by means of cold alkali. By using different phenolic acids, it is possible to synthesise a large variety of depsides. When the hydroxyl group is *meta* or *para* to the carboxyl group, the phenolic acid is readily carboxymethylated, but *ortho*-hydroxyl groups are very resistant under the same conditions (steric effect; see Vol. I). Reaction can, however, be brought about by condensing *o*-hydroxyacids with methyl chloroformate in the presence of a base, *e.g.*, dimethylaniline. There is also the further difficulty that *ortho*-hydroxyl groups do not react with acid chlorides (steric effect). This has been overcome by condensing an acid chloride with an *o*-phenolic aldehyde, *e.g.*,

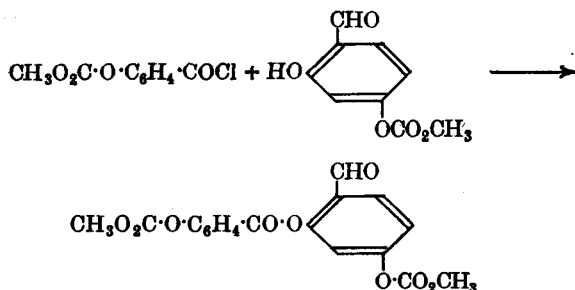

**§16. Tannins.** These are widely distributed in plants; many are glycosides. One of the best sources of tannin is nutgall. The tannins are colourless non-crystalline substances which form colloidal solutions in water; these

solutions have an astringent taste. Tannins precipitate proteins from solution, and they form a bluish-black colour with ferric salts, a property which is used in the manufacture of ink. Tannins also precipitate many alkaloids from their solutions.

All tannins contain polyhydroxyphenols or their derivatives. Some tannins are hydrolysable by acids, and others are not; those which can be hydrolysed by acid give variable yields of gallic acid.

#### READING REFERENCES

- Gilman (Ed.), *Advanced Organic Chemistry*, Wiley (1943, 2nd ed.). Vol. II. Ch. 18. The Anthocyanins and the Flavones.
- Stewart and Graham, *Recent Advances in Organic Chemistry*, Longmans, Green. Vol. II (1948, 7th ed.). (i) Ch. 10. Anthocyanins. (ii) Ch. 11. Depsides and Tannins.
- Perkin and Everest, *The Natural Organic Colouring Matters*, Longmans, Green (1918).
- Elderfield (Ed.), *Heterocyclic Compounds*, Wiley, Vol. II (1951). (i) Ch. 8. Chromones, Flavones and Isoflavones. (ii) Ch. 9. Chromenols, Chromenes and Benzopyrylium Salts.
- Rodd (Ed.), *Chemistry of the Carbon Compounds*, Elsevier. Vol. IVB (1959); pp. 855-; 903-; 935-. Flavonoids, etc.
- Bentley, *The Natural Pigments*, Interscience (1960).
- Hill, The Synthesis and Structure of Benzopyrylium (Chromylium) Salts, *Chem. Reviews*, 1936, **19**, 27.
- Robinson, Natural Colouring Matters and their Analogues, *Chem. and Ind.*, 1933, 737.
- Robinson, Über die Synthese von Anthocyaninen, *Ber.*, 1934, **67A**, 85.
- Robinson, Chemistry of the Anthocyanins, *Nature*, 1935, **135**, 732.
- Warburton, The *iso*Flavones, *Quart. Reviews (Chem. Soc.)*, 1954, **8**, 67.
- Jain and Seshadri, Nuclear Methylation of Flavones and Related Compounds, *Quart. Reviews (Chem. Soc.)*, 1956, **10**, 169.
- Seshadri, Recent Developments in the Chemistry of Flavonoids, *Tetrahedron*, 1959, **6**, 169.

CHAPTER XVI  
PURINES AND NUCLEIC ACIDS

§1. **Introduction.** Purine is the parent substance of a group of cyclic diureides and was used by E. Fischer to name systematically the naturally occurring derivatives. Purine exists in two tautomeric forms, and its structure consists of a pyrimidine ring fused to an imidazole ring. In the earlier literature, the formula of purine was written as follows (the method of numbering is also shown):

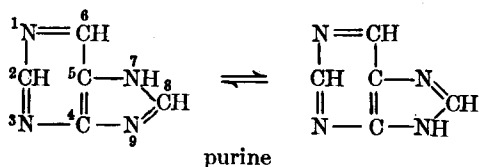

These formulæ have been written as in A, but more recently, the practice is to write the nitrogen of the pyrimidine ring at the top as in B (*cf.* diazines,

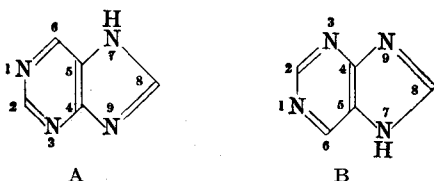

§10. XII). In this book, formula A is used (B is A turned upside down; there is no change in numbering, and so the reader can readily translate A into B).

§2. **Uric acid.** Guano (birds' excrement found on islands near the western coast of South America) contains up to about 25 per cent. uric acid; about 90 per cent. of snakes' excrement is ammonium urate. Small amounts of uric acid are also present in human urine; it was first discovered by Scheele (1776) in urinary calculi.

Liebig and Wöhler (1834) showed that the molecular formula of uric acid is  $C_5H_4O_3N_4$ . These authors also found, in 1838, that the oxidation of uric acid with nitric acid gives alloxan and urea in equimolecular proportions.

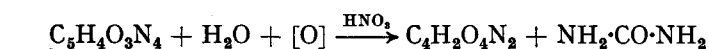

**Structure of alloxan,  $C_4H_2O_4N_2$ .** When hydrolysed with alkali, alloxan produces one molecule of urea and one molecule of mesoxalic acid.

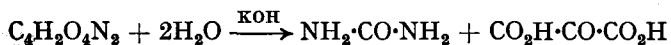

Since alloxan contains no free amino or carboxyl groups, the products of hydrolysis suggest that alloxan is mesoxalylurea; this cyclic structure has been confirmed by the direct union of urea and mesoxalic acid to give alloxan (Liebig and Wöhler, 1838).

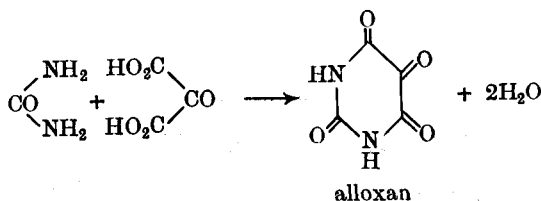

Alloxan, as its monohydrate, is conveniently prepared from barbituric acid as follows (see also §13a. XII):

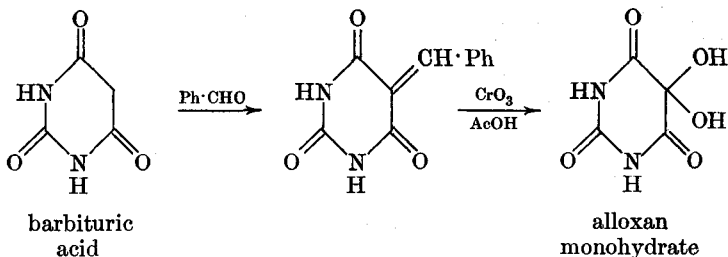

Alloxan is a strongly acid compound (in the *enol* form); it crystallises with four molecules of water of crystallisation. Three of these are readily lost on warming, but the fourth is lost only when the monohydrate is heated to 150°. Because of this, it is believed that the fourth molecule of water is not water of crystallisation but water of constitution (*cf.* chloral hydrate, Vol. I).

Alloxan stains the skin purple (due to the formation of murexide). The 5-oxime of alloxan is violuric acid (§13b. XII), and when reduced with zinc and hydrochloric acid, alloxan forms dialuric acid (§13b. XII). When alloxan is reduced with hydrogen sulphide, the product is *alloxantin*. According to Tipson *et al.* (1951), however, if excess of hydrogen sulphide is used, the product is dialuric acid only. Alloxantin is produced by reducing alloxan (one molecule) with half a molecule of hydrogen sulphide, or by mixing aqueous solutions of alloxan and dialuric acid.

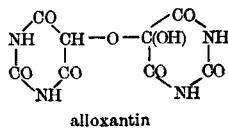

When heated with ammonia in ethanolic solution, alloxantin forms *murexide*, which is the ammonium salt of *purpuric acid* (an unstable compound).

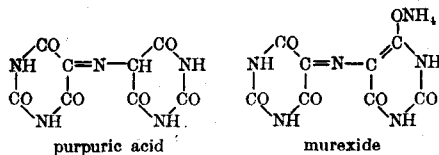

Murexide is soluble in water, giving a purple solution which turns blue on the addition of alkali. Purpuric acid slowly hydrolyses in solution to form alloxan and uramil.

When uric acid is oxidised with an aqueous suspension of lead dioxide, the products are allantoin and carbon dioxide (Liebig and Wöhler, 1838). These products are obtained in quantitative yield if the oxidation is carried out with alkaline permanganate (Behrend, 1904).

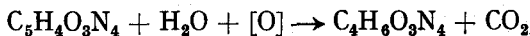

**Structure of allantoin,  $C_4H_6O_3N_4$**  (Baeyer, 1861–1864). When hydrolysed with alkali, allantoin forms two molecules of urea and one molecule of glyoxylic acid.



The formation of these hydrolytic products suggests that allantoin is the diureide of glyoxylic acid.

On oxidation with nitric acid, allantoin forms urea and *parabanic acid* in equimolecular proportions.



Now parabanic acid, on hydrolysis, gives urea and oxalic acid, and since there are no free amino or carboxyl groups present in the molecule, this suggests that parabanic acid is oxalylurea.

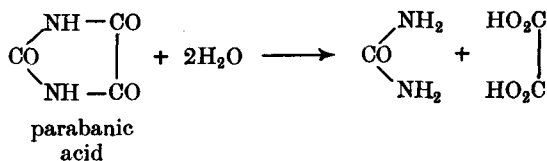

This structure has been confirmed by synthesis, *e.g.*, oxalyl chloride condenses with urea to form parabanic acid (Bornwater, 1912).

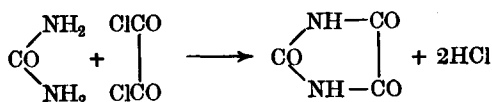

Thus, from the above facts, it can be seen that allantoin contains the parabanic acid nucleus joined to a molecule of urea. The point of the attachment is deduced from the following experimental evidence. When reduced with concentrated hydriodic acid at  $100^\circ$ , allantoin forms urea and *hydantoin*.



Hydantoin, on controlled hydrolysis, gives *hydantoic acid* (*ureido-acetic acid*) and this, on further hydrolysis, gives glycine, ammonia and carbon dioxide. These results suggest that hydantoin is glycollylurea.

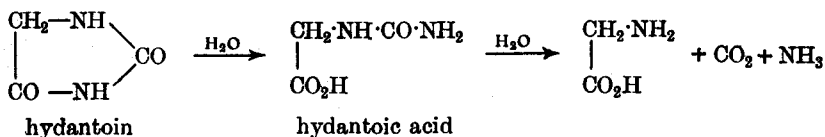

This structure for hydantoin has been confirmed by synthesis, *e.g.*, West (1918).

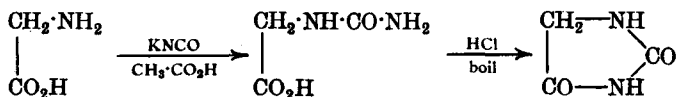

Hydantoin, m.p.  $216^\circ$ , may also be prepared by the electrolytic reduction of parabanic acid, or by the action of bromoacetyl bromide on urea.

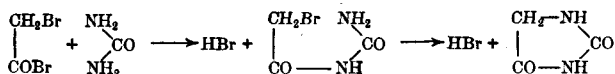

Hydantoin behaves as a tautomeric substance; the enol form is acidic and forms salts.

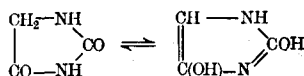

Hydantoin is oxidised to parabanic acid by bromine water.

Thus the following structure for allantoin would account for all of the foregoing results:

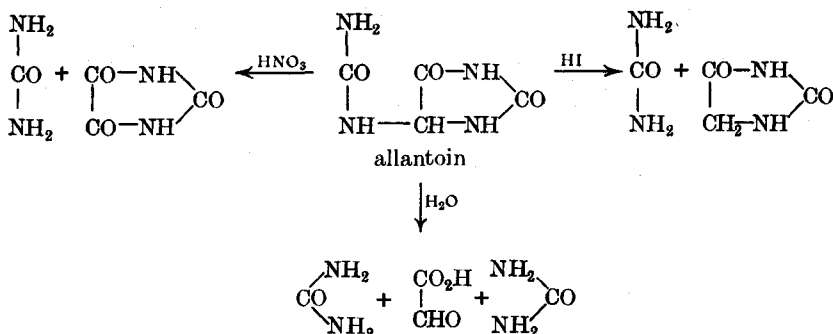

This has been confirmed by synthesis by heating urea with glyoxylic acid at 100° (Grimaux, 1876).

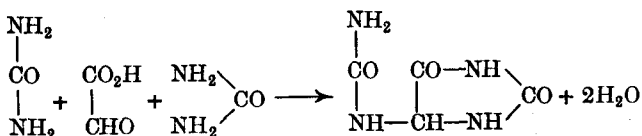

Examination of the structure of allantoin shows that it contains an asymmetric carbon atom; hence two optically active forms are possible. Both forms have been obtained, and they have been found to racemise rapidly in solution; the racemisation probably occurs *via* enolisation (*cf.* §8 iii. II).

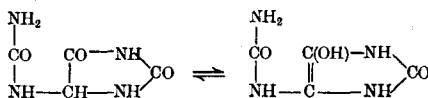

In the formation of allantoin from uric acid by oxidation, one carbon atom is lost from the latter as carbon dioxide. The problem, then, is to fit one carbon atom into the allantoin structure. At the same time, the structure thus given to uric acid must also include the alloxan skeleton in order to account for the formation of this compound. Two structures that were proposed which both agreed with the facts known at the time were by Medicus (1875) and by Fittig (1878).

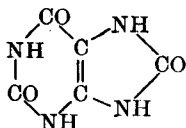

Medicus formula

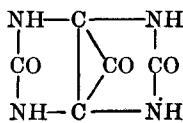

Fittig formula

Fischer (1884) prepared two isomeric monomethyluric acids; one gave methylalloxan and urea on oxidation with nitric acid, and the other gave

alloxan and methylurea. Fittig's formula, which is symmetrical, can give rise to only *one* monomethyluric acid; hence this structure is untenable. On the other hand, the Medicus formula satisfies the existence of at least two isomeric monomethyl derivatives: one methyl group in the pyrimidine nucleus (at position 1 or 3) would produce methylalloxan and urea, and a methyl group in the imidazole nucleus (at position 7 or 9) would produce alloxan and methylurea (Fischer showed that the two monomethyluric acids were the 3- and 9-derivatives). Examination of the Medicus formula shows that it admits the possibility of four monomethyl, six dimethyl and four trimethyl derivatives. All of these have been prepared by Fischer and his co-workers, thus giving powerful support to the Medicus formula. Proof of the Medicus formula lies in the synthesis of uric acid; three syntheses are given here.

(i) Behrend and Roosen (1888) carried out the first unambiguous synthesis (see also §15. XII).

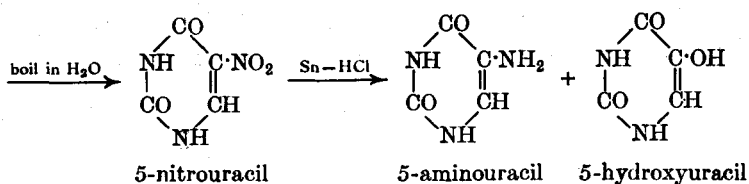
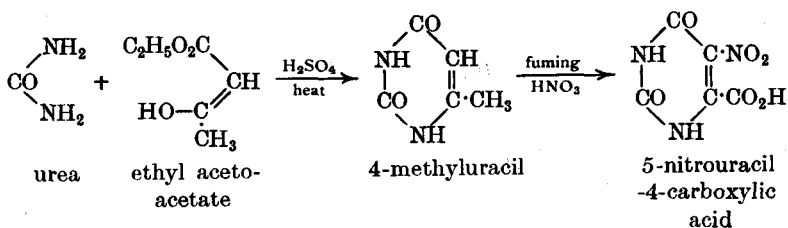

In this reduction, some of the aminouracil is converted into hydroxyuracil. The mechanism of this change is not certain, but a possibility is as follows:

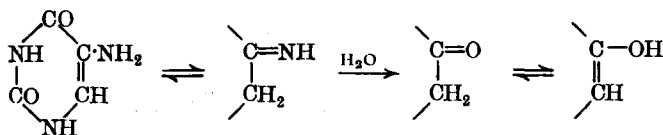

The reaction product was treated with nitrous acid, thereby converting the 5-aminouracil present into 5-hydroxyuracil; then the synthesis proceeded as follows:

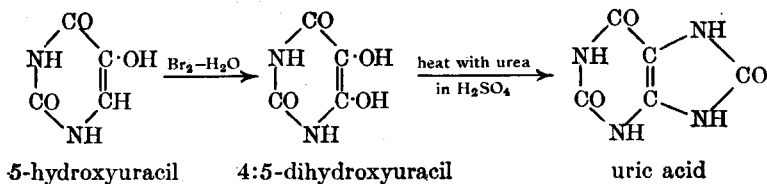

(ii) Baeyer's synthesis (1863), completed by Fischer (1895). Baeyer arrived at *p*-uric acid and knew that uric acid contained one molecule of water less than this, but was unable to remove it to form uric acid. His failure was due to the fact that *p*-uric acid is not dehydrated by the usual

dehydrating agents; Fischer succeeded by fusion with anhydrous oxalic acid, and also obtained better results by boiling  $\psi$ -uric acid with 20 per cent. hydrochloric acid.

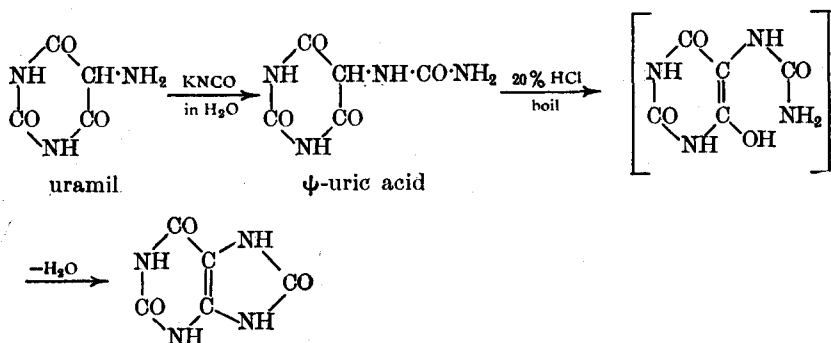
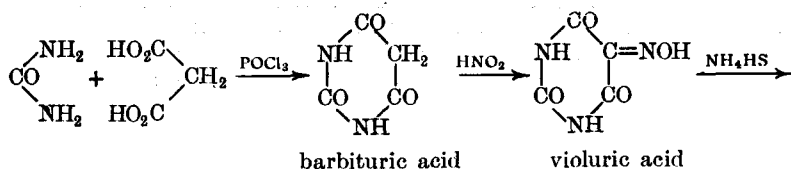

(iii) Traube's synthesis (1900) is the most important method, since it can be used to prepare any purine derivative; it is also the basis of various commercial methods for preparing the purines synthetically.

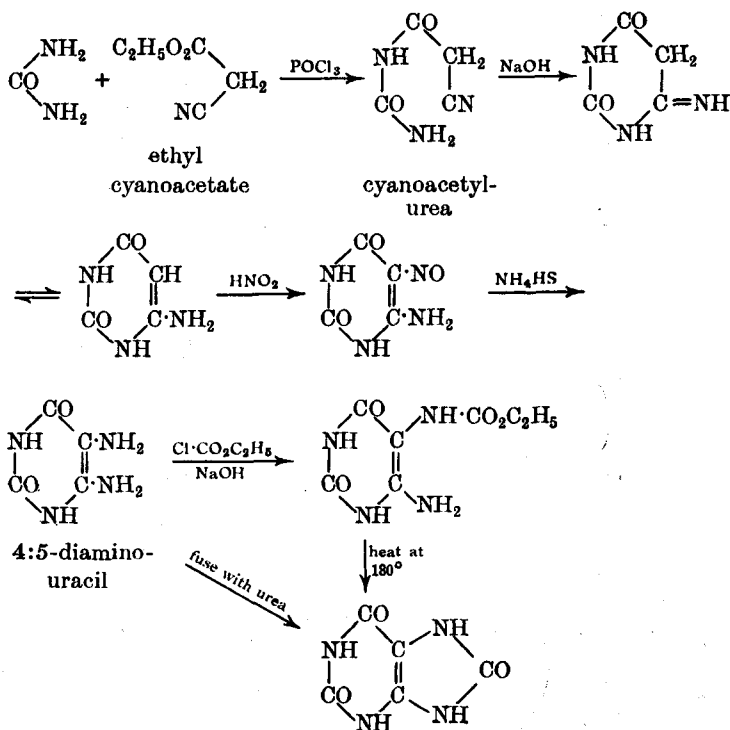



Clusius *et al.* (1953), using urea labelled with  $^{15}\text{N}$ , have shown that the two nitrogen atoms in the diaminouracil are retained on fusion with urea.

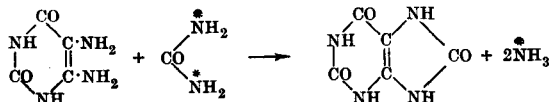

Uric acid is a white crystalline powder which is insoluble in the ordinary organic solvents. It behaves as a weak dibasic acid, forming two series of salts (*e.g.*, monosodium and disodium urate).

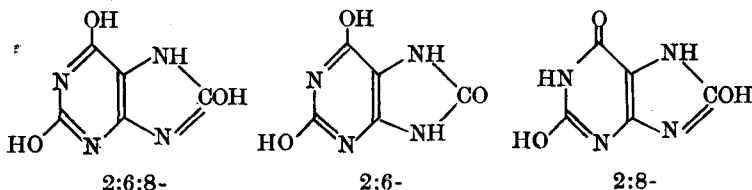

It thus appears that the tri-enol form (2 : 6 : 8-trihydroxypurine) is unlikely; this leaves three possible di-enol forms, 2 : 6-, 2 : 8- and 6 : 8-. Which of these di-enol forms is the one that forms the disodium salt still appears to be uncertain. Fischer thought that the di-enol form is the 2 : 6-. Evidence that may be quoted to support this is that in this arrangement the pyrimidine ring will be "aromatic" and so stabilised by resonance. There is, however, a certain amount of evidence which suggests the 2 : 8- di-enol form (*cf.* §§13a, 15).

It is also interesting to consider the path followed in the oxidation of uric acid to allantoin. Behrend (1904) suggested that the alkaline permanganate oxidation of uric acid (I) gives allantoin (III*a* and *b*) *via* the symmetrical intermediate II. Cavalieri *et al.* (1948) have carried out this oxidation using uric acid labelled with  $^{15}\text{N}$  at  $\text{N}_1$  and  $\text{N}_3$ , and found that the allantoin produced had this isotopic nitrogen distributed uniformly among all the four nitrogen atoms. This is in keeping with the intermediate formation of II.

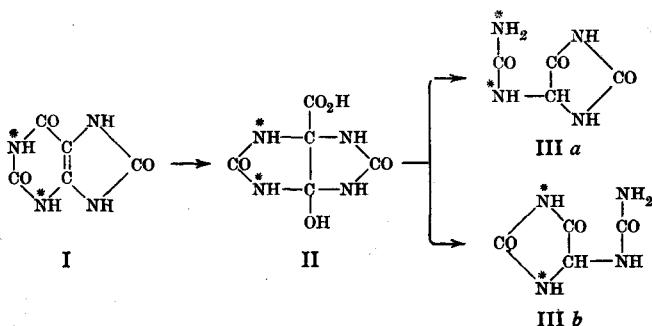

**§3. Purine.** When uric acid is treated with phosphoryl chloride, 2 : 6 : 8-trichloropurine is obtained (uric acid behaves as the tri-enol in this reaction). This trichloro compound is a very important intermediate in the synthesis of purine derivatives, and a point worth noting is that the reactivities of the chlorine atoms are  $6 > 2 > 8$ . **Purine**, m.p.  $217^\circ$ , may be prepared from uric acid as follows:

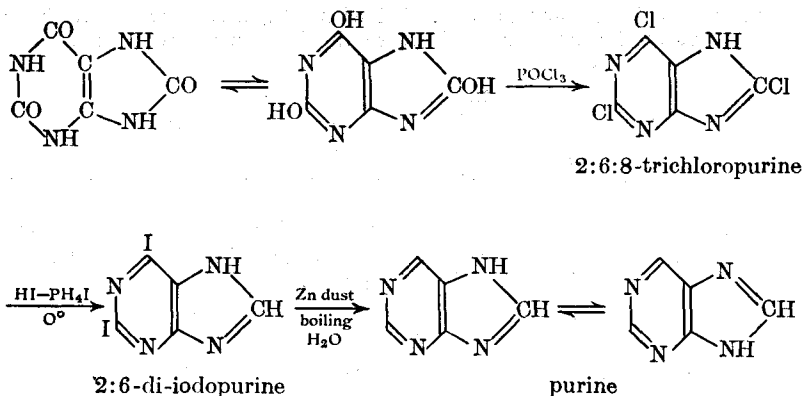

Purine is a fairly strong base and forms salts with acids; it has been found to occur naturally as its 9-D-ribofuranoside, *nebularine* (Löfgren *et al.*, 1953).

#### PURINE DERIVATIVES

**§4. Synthesis of purines.** Before describing some individual purine derivatives, let us first consider some general methods of synthesising purines. Fischer (1897, 1898) prepared various purines starting from 2:6:8-trichloropurine. There are, however, two general synthetic methods in which the pyrimidine ring is synthesised first and then the imidazole ring "built up" on this, or *vice versa*.

(i) *Traube's method.* This consists of synthesising a 4:5-diaminopyrimidine (see §14. XII) and then condensing with formic acid to produce the imidazole ring; the formyl derivative is ring-closed by heating alone or by heating its sodium salt.

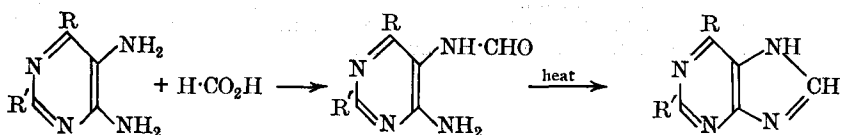

This synthesis leads to the preparation of purines that are unsubstituted in position 8. This type of purine may also be prepared by heating a 4:5-diaminopyrimidine with dithioformic acid in the presence of sodium hydroxide solution, and then heating the product with a methanolic solution of sodium methoxide.

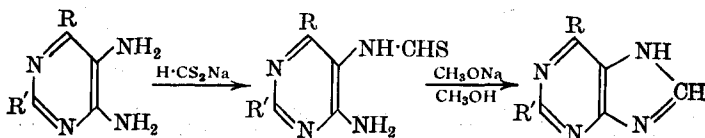

8-Hydroxypurines may be prepared by using ethyl chloroformate instead of formic acid. Alternatively, the diaminopyrimidine may be boiled with potassium isocyanate and the product, a ureidopyrimidine, ring-closed by

heating. Finally, diaminopyrimidines may be fused with urea to produce 8-hydroxypurines.

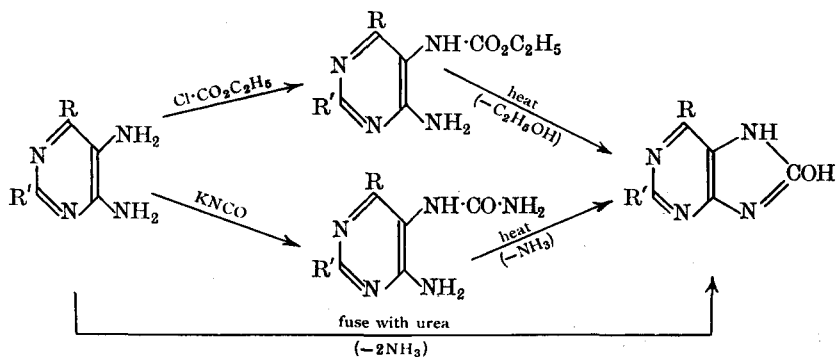

*o*-Aminohydroxypyrimidines may be used instead of *o*-diaminopyrimidines (cf. Baeyer's synthesis of *ψ*-uric acid, §2).

Bergmann *et al.* (1961) have prepared 8-substituted purines by condensing 4,5-diaminopyrimidines with amidine salts, *e.g.*,

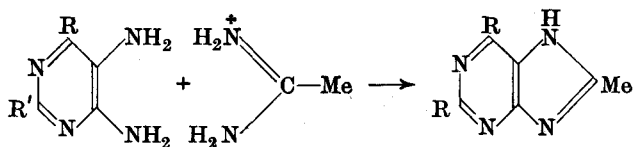

(ii) A less frequently used synthesis of purines starts with the imidazole derivative, *e.g.*, 7-methylxanthine from 4-amino-1-methylimidazole-5-carbonamide (Sarasin *et al.*, 1924):

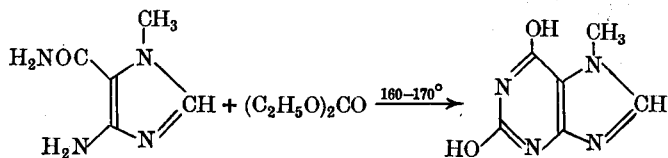

§5. Adenine (6-aminopurine), d. 365°, occurs in the pancreas of cattle and in tea extract. Its general reactions showed that adenine was a purine, and its structure was established by synthesis.

(i) Fischer (1897) (see also §6).

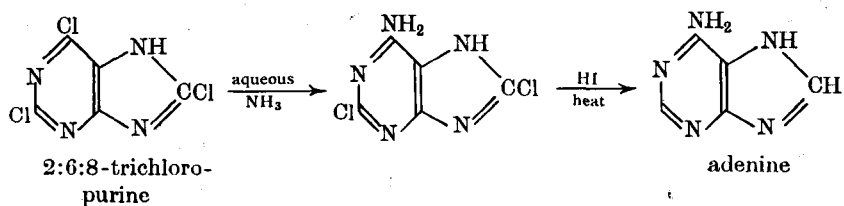

(ii) Traube (1904).

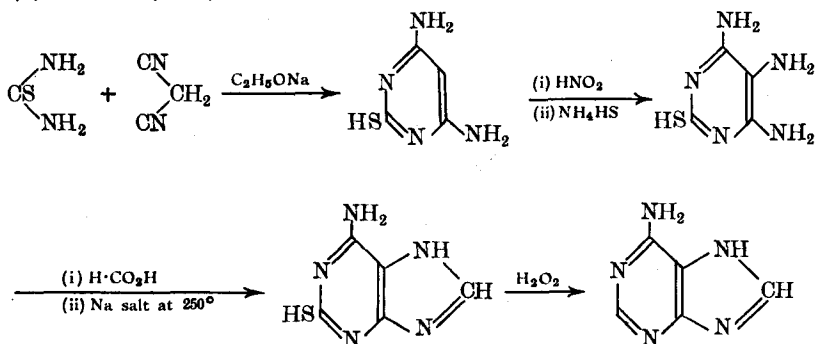
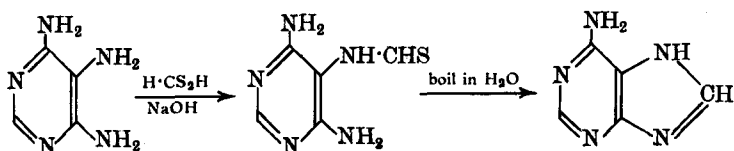
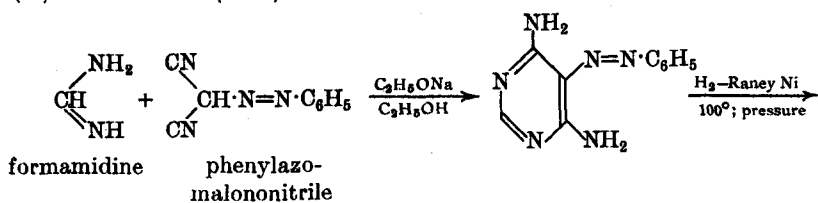
(iii) Todd *et al.*, (1943).

§6. **Hypoxanthine** (6-hydroxypurine), d. 150°, occurs in tea extract and in animal tissues. Its formation by the action of nitrous acid on adenine establishes its structure, and this is confirmed by synthesis.

(i) Fischer (1897, 1898).

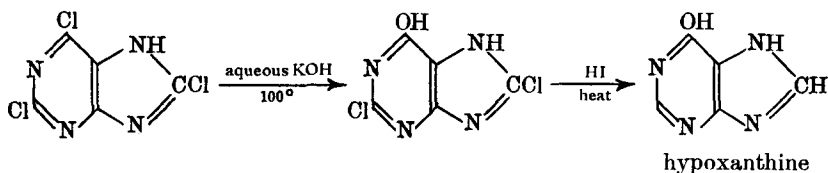

(ii) Traube (1904).

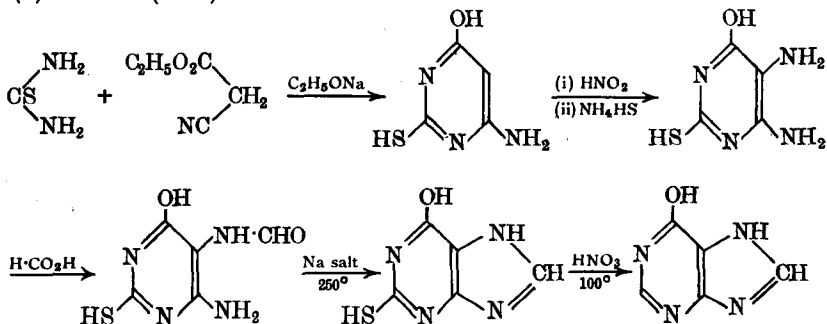

A new useful synthesis of hypoxanthines and adenines involves the condensation between 1,2,2-trimethylaminoacrylamide and ortho-esters (Richter *et al.*, 1960), *e.g.*, hypoxanthine:

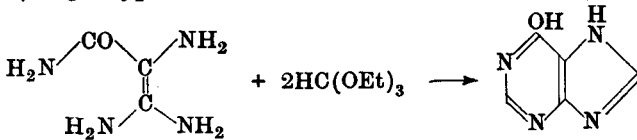

§7. **Xanthine** (2 : 6-dihydroxypurine), d. above  $150^\circ$ , occurs in tea extract and in animal tissues. When oxidised with potassium chlorate in hydrochloric acid solution, xanthine forms alloxan and urea; these products show the relationship of xanthine to uric acid, and its structure has been established by synthesis.

(i) Fischer (1898) (see also §10).

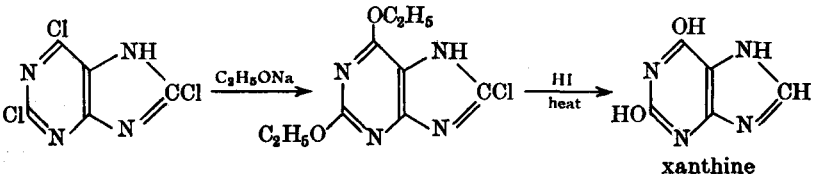

(ii) Traube (1900).

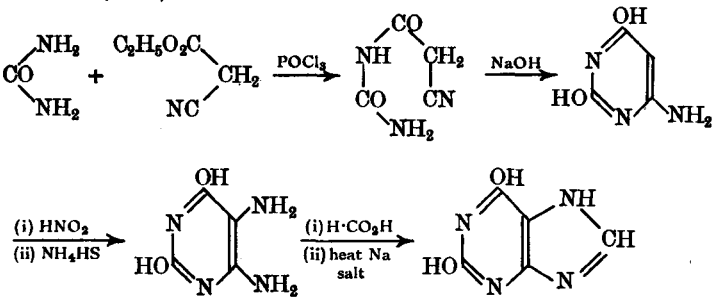

Xanthine is the parent substance of a number of compounds (see later).

§8. **Guanine** (2-amino-6-hydroxypurine), d.  $360^\circ$ , occurs in the pancreas of cattle, in guano and in certain fish scales. Its structure is shown by the fact that it gives xanthine on treatment with nitrous acid; this conversion is also effected by boiling guanine with 25 per cent. hydrochloric acid (Fischer, 1910) (see also §13b).

(i) Fischer (1897).

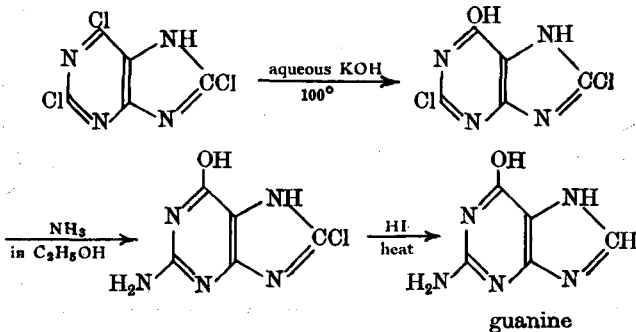

(ii) Traube (1900).

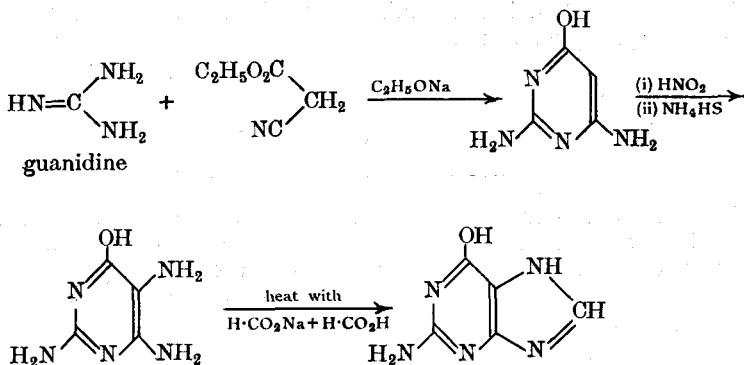

## XANTHINE BASES

Three important methylated xanthines that occur naturally are caffeine, theobromine and theophylline. All three have been prepared from uric acid by Fischer and all have been synthesised by means of the Traube method.

**§9. Caffeine** (1 : 3 : 7-trimethylxanthine), m.p. 235–237°, occurs in tea, coffee, etc. Its molecular formula is  $\text{C}_8\text{H}_{10}\text{O}_4\text{N}_4$ , and its relationship to uric acid is shown by the fact that on oxidation with potassium chlorate in hydrochloric acid, caffeine gives dimethylalloxan and methylurea in equimolecular proportions. The structure of the former product is established by its conversion into *sym.*-dimethylurea and mesoxalic acid on hydrolysis, and is confirmed by synthesis from these two compounds.

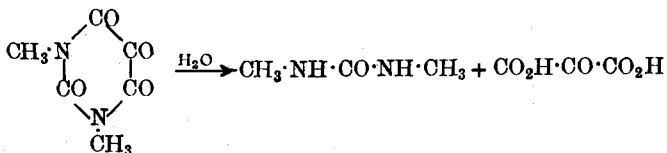

These results indicate that caffeine and uric acid have the same skeleton structure; at the same time the positions of two methyl groups and one oxygen atom in caffeine are also established. Thus the problem now is to ascertain the positions of the remaining methyl group and oxygen atom. The following skeleton structure for caffeine summarises the above information; the third methyl group is at either position 7 or 9, and the remaining oxygen atom at 6 or 8.

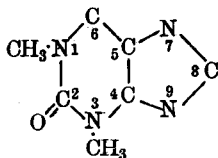

*Position of the methyl group.* As we have seen above, the oxidation of caffeine gives dimethylalloxan and methylurea. Fischer, however, also iso-

lated another oxidation product which, on hydrolysis, gave *N*-methylglycine, carbon dioxide and ammonia. Thus this third oxidation product must be *N*-methylhydantoin:

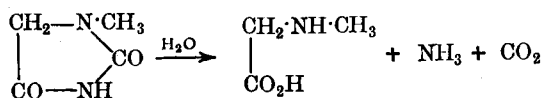

It therefore follows that caffeine contains two ring structures, that of dimethylalloxan and that of methylhydantoin. The following two skeleton structures for caffeine are both possible, since each could give the required oxidation products. Actually, the isolation of methylurea suggests I or II;

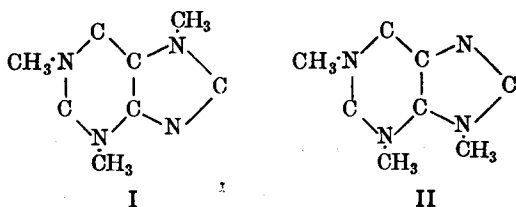

the isolation of methylhydantoin confirms these possibilities. Finally, Fischer isolated a fourth oxidation product, *viz.*, *sym.*-dimethylloxamide,  $\text{CH}_3\cdot\text{NH}\cdot\text{CO}\cdot\text{CO}\cdot\text{NH}\cdot\text{CH}_3$ . Examination of I and II shows that only I can give rise to the formation of this oxamide, and so I is the skeleton of caffeine.

*Position of the oxygen atom.* In view of what has been said above, we see that there are now two possible structures for caffeine which fit the facts equally well:

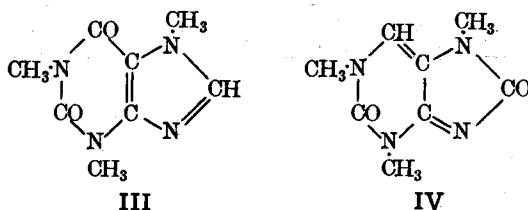

By analogy with uric acid, III would appear the more likely one; this, however, is not proof. Fischer showed that III is caffeine as follows.

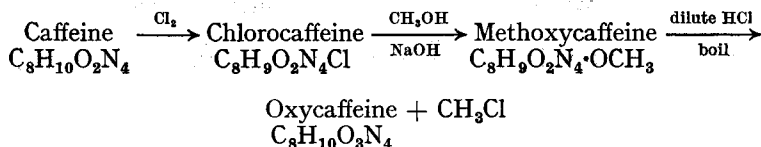

Fischer then showed that oxycaffeine was identical with a trimethyluric acid, since on methylation with methyl iodide in the presence of aqueous sodium hydroxide, oxycaffeine was converted into tetramethyluric acid. Thus methoxycaffeine is either V or VI, and oxycaffeine VII or VIII.

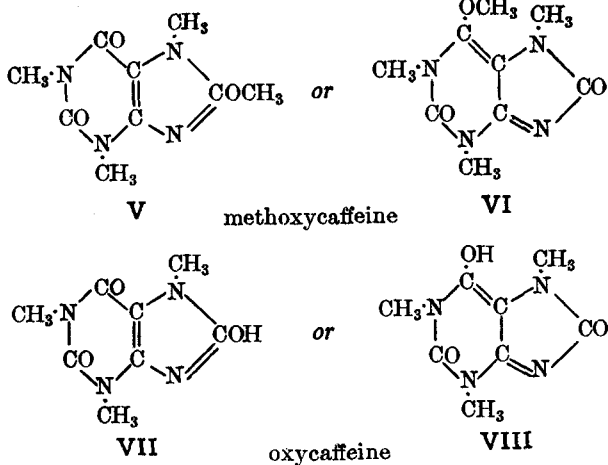

When oxycaffeine, as its silver salt, is heated with methyl iodide, it is converted into a mixture of tetramethyluric acid (which contains four *N*-methyl groups) and methoxycaffeine (which contains three *N*-methyl groups and one methoxyl group). The simultaneous formation of these two products suggests that oxycaffeine is a tautomeric substance, *i.e.*, it contains the *amido-imidol triad system*:

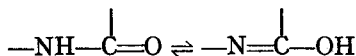

Now this triad system can exist only in the imidazole nucleus in oxycaffeine, since neither nitrogen atom in the pyrimidine nucleus is attached to a hydrogen atom (VII can give rise to the above tautomeric system, whereas VIII cannot). Thus the methoxyl group in methoxycaffeine is in the imidazole nucleus, and consequently the chlorine atom in chlorocaffeine is also in this nucleus; hence caffeine is IX and chlorocaffeine is X.

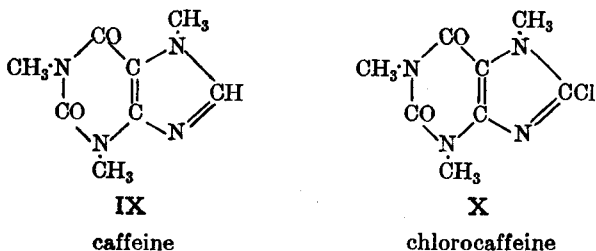

This structure for caffeine has been confirmed by various syntheses, *e.g.*,



(i) Fischer (1899) (see also §10).

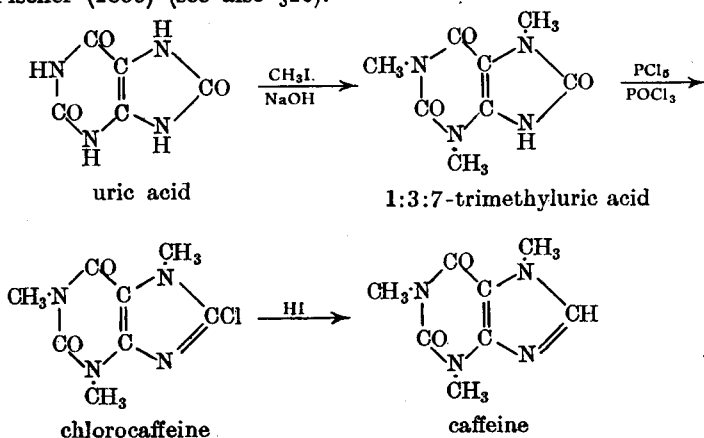

(ii) A commercial synthesis based on Traube's method is as follows:

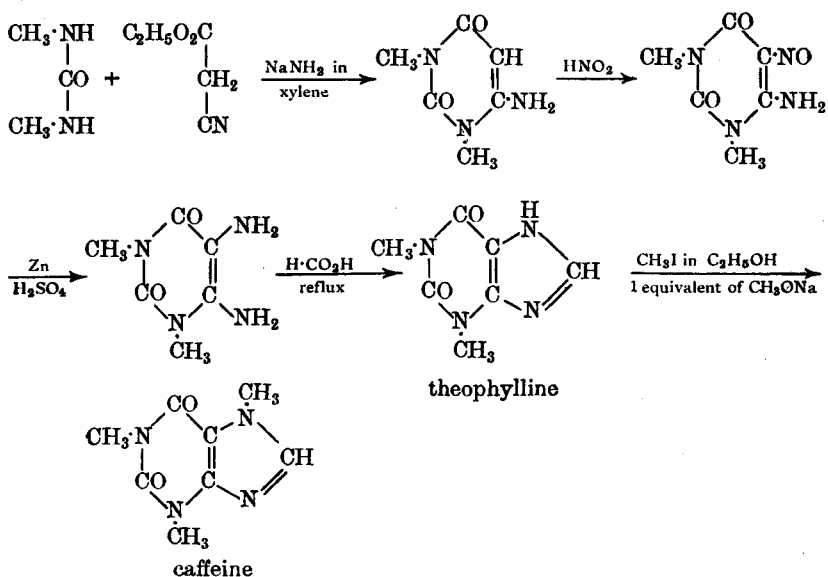

§10. **Theobromine** (3:7-dimethylxanthine), m.p. 337°, occurs in cocoa beans, tea, etc. The structure of theobromine has been deduced from the fact that, on oxidation with potassium chlorate in hydrochloric acid; it gives methylalloxan and methylurea, and also that it is converted into caffeine when its silver salt is heated with methyl iodide. Thus theobromine is either I or II.

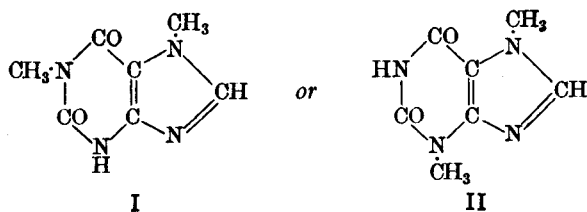

The position of the methyl group in the pyrimidine nucleus has been shown to be 3 (*i.e.*, structure II) by synthesis using Traube's method.

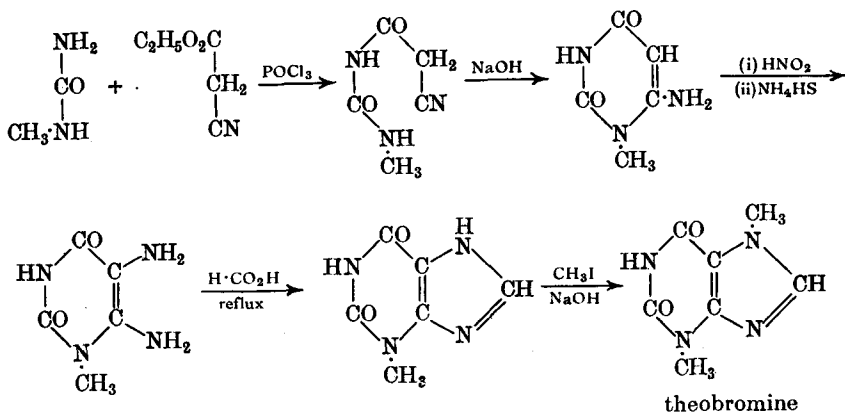

The product formed by the condensation between methylurea and ethyl cyanoacetate contained no free amino-group; thus the condensation must occur as shown (and not by the carboxyl group with the methylimino-group of the methylurea).

Fischer (1899) also prepared theobromine from uric acid as follows:

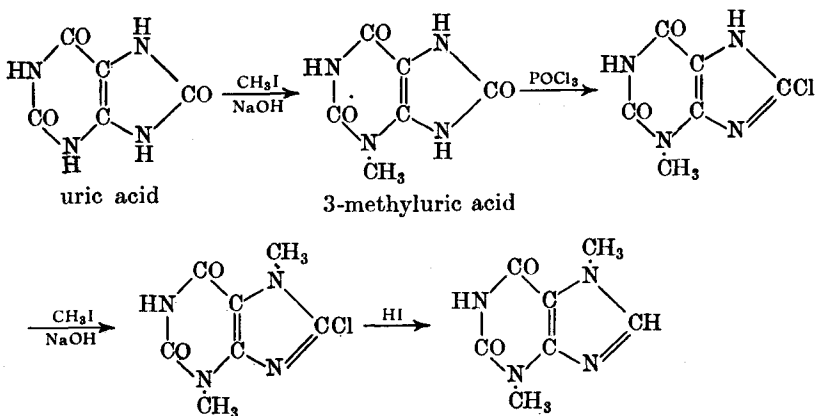

It should be noted that in this synthesis a mixture of phosphorus pentachloride and phosphoryl chloride cannot be used; this mixture replaces the oxygen atom (*i.e.*, the hydroxyl group) at position 6 and not at 8.

The simplest method of preparing xanthine (§7), caffeine (§9) and theobromine from uric acid is probably that of Bredereck (1950):

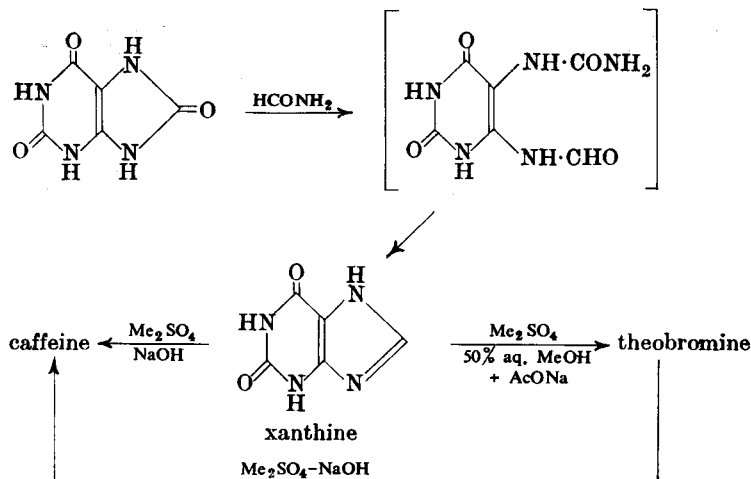

§11. **Theophylline** (1 : 3-dimethylxanthine), m.p. 269–272°, occurs in tea. Its structure has been deduced from the fact that it is converted into caffeine on methylation, and that it forms dimethylalloxan and urea on oxidation. Thus theophylline is 1 : 3-dimethylxanthine, and this structure has been confirmed by synthesis.

(i) Fischer (1899).

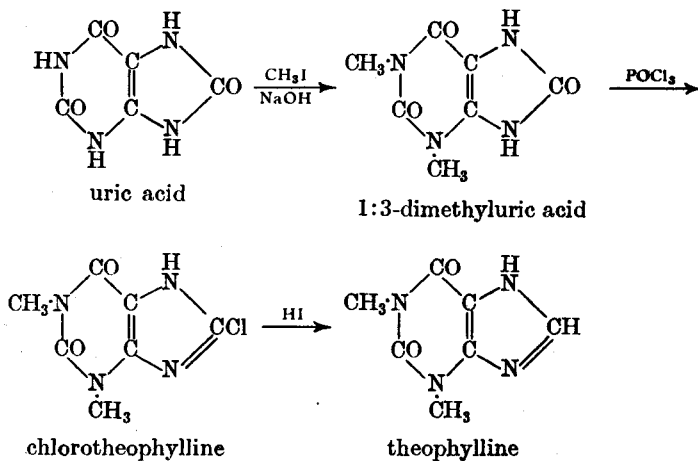

(ii) Theophylline has also been synthesised commercially by means of the Traube method (*cf.* caffeine, §9).

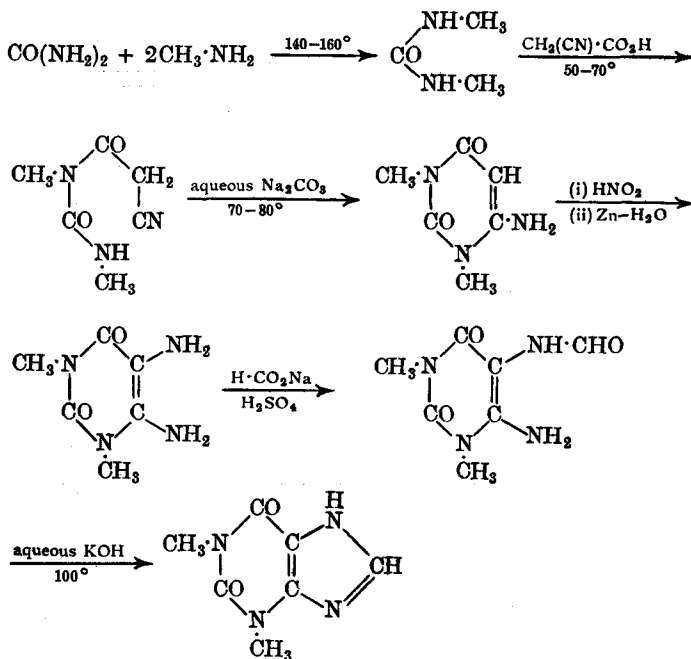

**§11a. Biosynthesis of purines.** Most of the work on the biosynthesis of purines has been carried out on uric acid by means of enzymes from bird liver. Sonne *et al.* (1946, 1948), working with the following labelled compounds ( $^{13}\text{C}$ ), showed that carbon dioxide supplies  $\text{C}_6$ , formic acid  $\text{C}_2$  and  $\text{C}_8$ , and glycine  $\text{C}_4$ ,  $\text{C}_5$  and  $\text{N}_7$ . Thus all the carbon atoms in uric acid are accounted for. It has also been shown that the carbon atoms in hypoxanthine are derived from the same precursors as those in uric acid. Furthermore, it was also shown that in the hypoxanthine biosynthesis in liver extracts,  $\text{N}_7$  is derived from glycine,  $\text{N}_3$  and  $\text{N}_9$  are derived from the amide nitrogen of glutamine (§2. XIII; number 23 in the list of amino-acids) and  $\text{N}_1$  is derived from aspartic acid (number 19 in list). According to Buchanan *et al.* (1948-) and Greenberg *et al.* (1951), hypoxanthine is produced from inosine-5'-phosphate (the nucleotide of hypoxanthine; see §13d). Inosine-5'-phosphate is believed to be biosynthesised as follows from ribose 5-phosphate 1-pyrophosphate (ATP is the co-enzyme adenosine triphosphate):

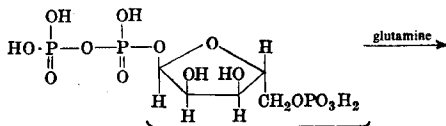

This fragment is X in the following reactions

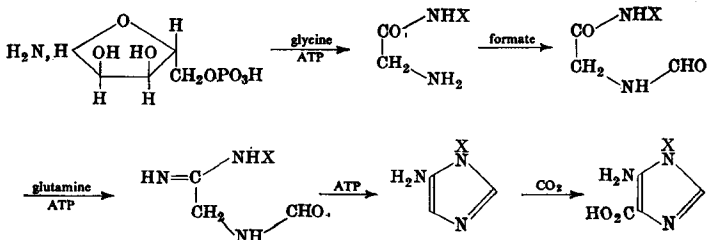

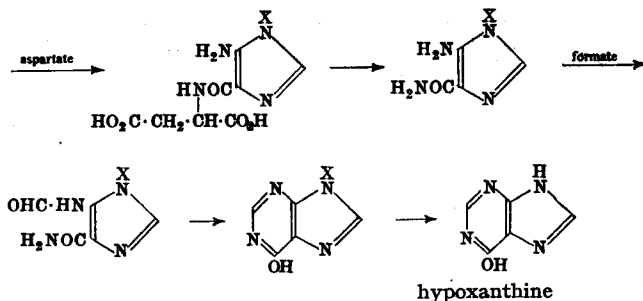

Oró (1961) has shown that adenine and the purine precursors 4-aminoimidazole-5-carboxamide and formamidine are formed spontaneously from hydrogen cyanide in water-ammonia systems under conditions assumed to have existed on primitive Earth (*cf.* §18. XIII). Oró has also suggested a mechanism for the formation of adenine from hydrogen cyanide under the above conditions.

### NUCLEIC ACIDS

**§12. Introduction.** Nucleoproteins are one of the classes of conjugated proteins (§7 B. XIII); the nucleic acid part is the prosthetic group, and the protein part consists of protamines and histones. These latter compounds are basic and form salt-like compounds, the nucleoproteins, with the nucleic acids. On careful hydrolysis, nucleoproteins are broken down into the nucleic acid and protein.

Genes are the units of inheritance, and there is now a great deal of evidence to show that a gene is a nucleic acid molecule.

**§13. Structure of the nucleic acids.** Nucleic acids are colourless solids, all of which contain the following elements: carbon, hydrogen, oxygen, nitrogen and phosphorus. The following chart shows the nature of the products obtained by hydrolysis under different conditions.

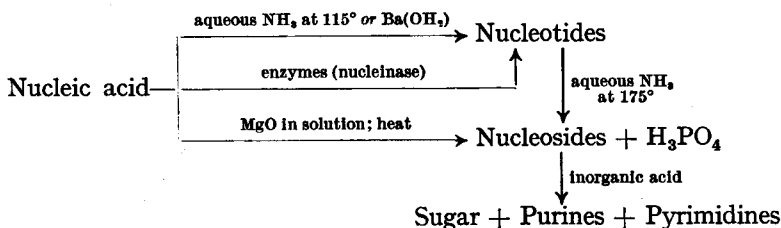

Hayes (1960) has shown that ribonucleic acids (§13a) may be rapidly and quantitatively degraded to ribonucleosides by refluxing with 50 per cent. aqueous formamide.

**§13a. Sugars.** Only two sugars have been isolated from the hydrolysates of nucleic acids; both are pentoses: D(-)-ribose and 2-deoxy-D(-)-ribose.

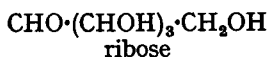

The nucleic acids are classified according to the nature of the sugar present: the *pentose nucleic acids* or *ribonucleic acids* (R.N.A.), and the *deoxypentose nucleic acids* or *deoxyribonucleic acids* (D.N.A.). Ribonucleoproteins are

found mainly in the cytoplasm of the cell, whereas deoxyribonucleoproteins are found mainly in the cell nucleus. D(-)-Ribose is the pentose of yeast, liver and pancreas R.N.A.s; 2-deoxy-D(-)-ribose occurs in thymus D.N.A. Nucleic acids also occur in plant and animal viruses. The principal function of the nucleic acids appears to be in protein synthesis. Evidence has been obtained that the D.N.A.s act as carriers of genetic continuity (see §18. XIII).

Aldridge (1960) has shown that the addition of indium chloride solution to acetate-buffered solutions of nucleic acids in the presence of sodium chloride produces a precipitate containing indium and nucleic acid. Furthermore, by varying the concentration of the sodium chloride, it is possible to precipitate either the R.N.A. or the D.N.A. from aqueous solution.

**§13b. Bases.** Until very recently, only two purines had been isolated from nucleic acids, adenine and guanine. In 1958, however, Littlefield *et al.* found 2-methyladenine and 6-methylaminopurine in R.N.A.s from several sources, and Adler *et al.* (1958) and Dunn *et al.* (1958) have shown that 2-methylamino- and 2-dimethylaminoguanine are widespread in R.N.A.s.

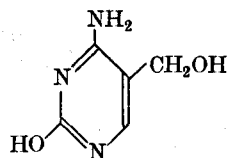
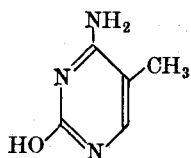
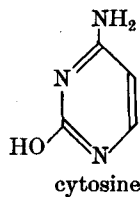
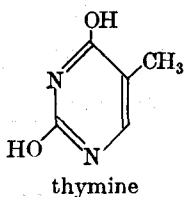
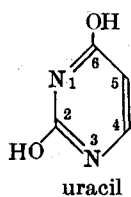
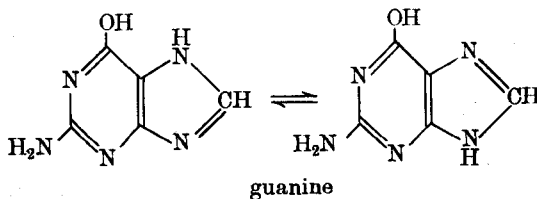
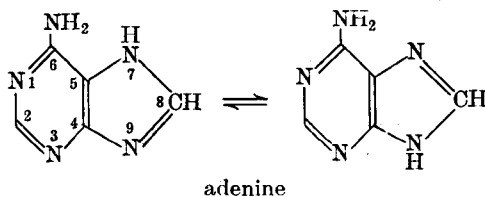

1-Methylguanine has also been found in minute quantities in R.N.A.s (Amos *et al.*, 1958). On the other hand, five pyrimidine bases have been isolated: uracil, thymine, cytosine, 5-methylcytosine and 5-hydroxymethylcytosine. Both types of nucleic acids (R.N.A.s and D.N.A.s) contain adenine and guanine. Cytosine also occurs in both types of nucleic acids, but uracil

occurs only in R.N.A.s. 5-Methylcytosine has been found to be a fairly common minor constituent of D.N.A.s, and Amos *et al.* (1958) have shown that it occurs in minute quantities in R.N.A.s (*cf.* methylguanine above). Also, thymine was believed to occur only in D.N.A.s, but Littlefield *et al.* (1958) have found it in R.N.A.s from several sources. 5-Hydroxymethylcytosine has been found in certain D.N.A.s (Wyatt *et al.*, 1952).

Angell (1961) has shown, from infra-red studies, that in the *solid* state and in ribose and deoxyribose nucleosides derived from these bases, adenine exists in the amino form, cytosine and guanine exist in the keto-amino form and uracil in the diketo form.

Combination of a base (either a purine or pyrimidine) with a sugar (ribose or deoxyribose) gives rise to a **nucleoside**, *e.g.*, adenosine (ribose + adenine), guanosine (ribose + guanine), cytidine (ribose + cytosine), uridine (ribose + uracil), thymidine (deoxyribose + thymine).

Combination of a nucleoside with phosphoric acid produces a **nucleotide**, *i.e.*, nucleotides are nucleoside phosphates, *e.g.*, adenylic, guanylic, cytidylic and uridylic acids. It might be noted here that the term nucleotide is now used to embrace a large group of compounds composed of the phosphates of *N*-glycosides of heterocyclic bases, and the pyrophosphates and polyphosphates containing one or more nucleosides. The term nucleotide also includes the nucleic acids themselves.

The problem now is to ascertain how these various units are linked in nucleosides and nucleotides.

**§13c. Structure of nucleosides.** Hydrolysis of nucleotides with aqueous ammonia at 175° under pressure gives nucleosides and phosphoric acid; thus in nucleosides the base is linked directly to the sugar. Furthermore, since nucleosides are non-reducing, the "aldehyde group" of the sugar cannot be free, *i.e.*, nucleosides are *glycosides* (*cf.* §24. VII). The next problem is to decide which atom of the base is joined to C<sub>1</sub> of the sugar. Let us first consider the pyrimidines. Cytidine, on treatment with nitrous acid, is converted into uridine; it therefore follows that the sugar residue is linked in the *same* position in both of these nucleosides. The point of linkage cannot be 1 or 6, since cytidine has a *free* amino-group at position 6 and consequently there cannot be a hydrogen atom on N<sub>1</sub>. Also, since uridine forms a 5-bromo derivative, C<sub>5</sub> must be free (Levene *et al.*, 1912). When uridine is treated with an excess of bromine, followed by the addition of phenylhydrazine, a uridine derivative is obtained which contains *two* phenylhydrazino radicals. This compound was given structure I since work by Levene (1925) showed

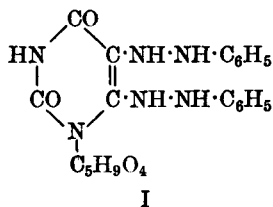

that this type of compound can be obtained only if uracil is substituted in position 3 and positions 4 and 5 are free. Thus the sugar is attached to N<sub>3</sub>. In a similar way, it has been shown that the other pyrimidine nucleosides (ribosides and deoxyribosides) have the sugar residue linked at N<sub>3</sub>. Todd *et al.* (1947) have synthesised uridine and cytidine, and thereby have confirmed the linkage at N<sub>3</sub>. This linkage has also been confirmed by the X-ray analysis of cytidine (Furberg, 1950).

Now let us consider nucleosides containing purine bases. Adenosine has

a free amino-group at position 6; therefore the sugar cannot be at  $C_6$  or  $N_1$  (*cf.* cytidine). Similarly, since guanosine has a free amino-group at position 2, the sugar cannot be at  $C_2$  or  $N_3$ . Now Levene found that the two purine ribosides are equally readily hydrolysed by dilute acids and by the same enzyme. He therefore assumed that the sugar residue is linked at the same place in both nucleosides. On this basis, only positions 7, 8 and 9 are possible points of attachment. Position 8 was then excluded since this point would involve a carbon-carbon bond, a linkage which would be very stable, whereas nucleosides are very readily hydrolysed by dilute acids (see also below). Thus positions 7 or 9 are free. This is supported by the following evidence (Levene, 1923). When guanosine is treated with nitrous acid, xanthosine is produced and this, on methylation with diazomethane followed by hydrolysis, gives theophylline (1:3-dimethylxanthine). Thus positions 1 and 3 are free in guanosine, and so the sugar must be attached at position 7 or 9. The evidence so far does not permit a decision to be made between these two positions since the system (in the imidazole nucleus) is tautomeric. It should be noted that had the sugar residue been attached to  $C_8$ , then a *trimethylxanthine* would have been obtained instead of theophylline (*cf.* above). The ultraviolet absorption spectrum of guanosine is very similar to that of 9-methylguanine and differs from that of 7-methylguanine; hence it appears likely that guanosine is the 9-guanine glycoside (Gulland *et al.*, 1936, 1938). Todd *et al.* (1947, 1948) have synthesised guanosine and adenosine in which the sugar is known to be in the 9-position, and showed that their synthetic compounds are identical with the natural products; *e.g.*, the synthesis of adenosine.

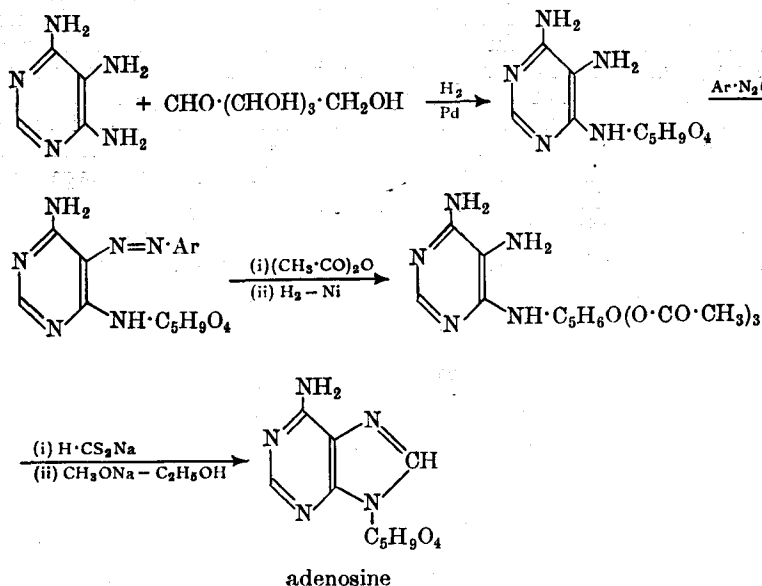

It might be noted, in passing, that glycosides are compounds formed by the linking of a sugar (at  $C_1$ ) with a COH group. Thus the nucleosides are, strictly speaking, not glycosides; they should be called ribosyl-pyrimidines and ribosyl-purines.

The final problem to be elucidated in connection with the structure of nucleosides is the nature of the ring in the sugar residue and the type of linkage ( $\alpha$  or  $\beta$ ). Degradative experiments have shown that the sugar is



present as the furanose form, *e.g.*, methylation of a pyrimidine riboside, followed by hydrolysis, gives a trimethylribose which, on oxidation, forms dimethylmesotartaric acid. This product shows that the ribose ring is furanose; had the ring been pyranose, then the final product would have been trimethoxyglutaric acid (*cf.* §§7a, 7b. VII).

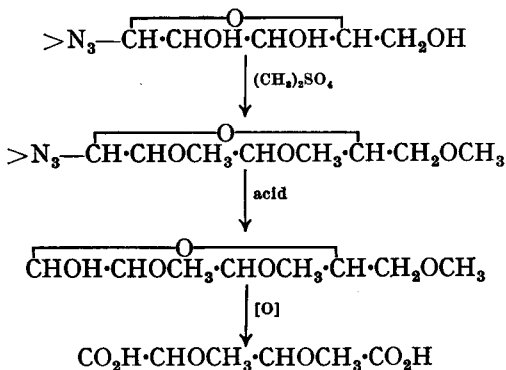

Deoxyribose has also been shown to be of the furanose type, *e.g.*, Lythgoe *et al.* (1950) found that pyrimidine deoxyribosides consume a negligible amount of periodic acid; this agrees with the 2-deoxyribofuranose structure since, in this state, the molecule does not contain two adjacent hydroxyl groups (*cf.* §7g. VII).

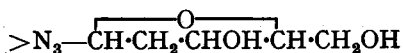

These results have been confirmed by other work (see below).

The configuration of the furanoside link has been shown to be  $\beta$ - by various means, *e.g.*, Todd *et al.* (1947) oxidised adenosine with periodic acid, and showed that the product is identical with that from the oxidation of 9- $\beta$ -D-mannopyranosidyladenine (a synthetic compound). This proves that

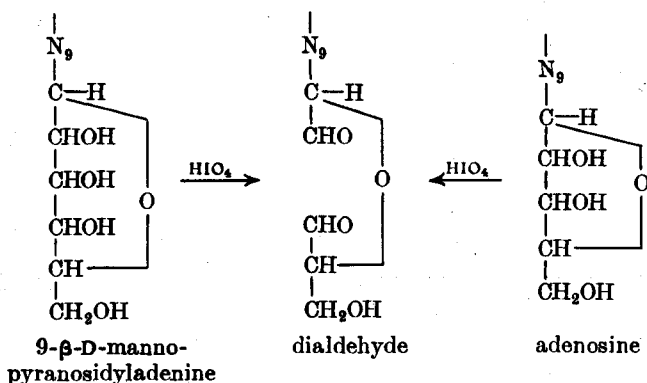

the sugar residue is at position 9, has the furanose structure and that the linkage is  $\beta$ -. Similar experiments with other ribonucleosides suggest that all these compounds have a  $\beta$ -configuration. Also, Todd *et al.* (1946-1948) have synthesised adenosine, guanosine, cytidine and uridine, and thereby

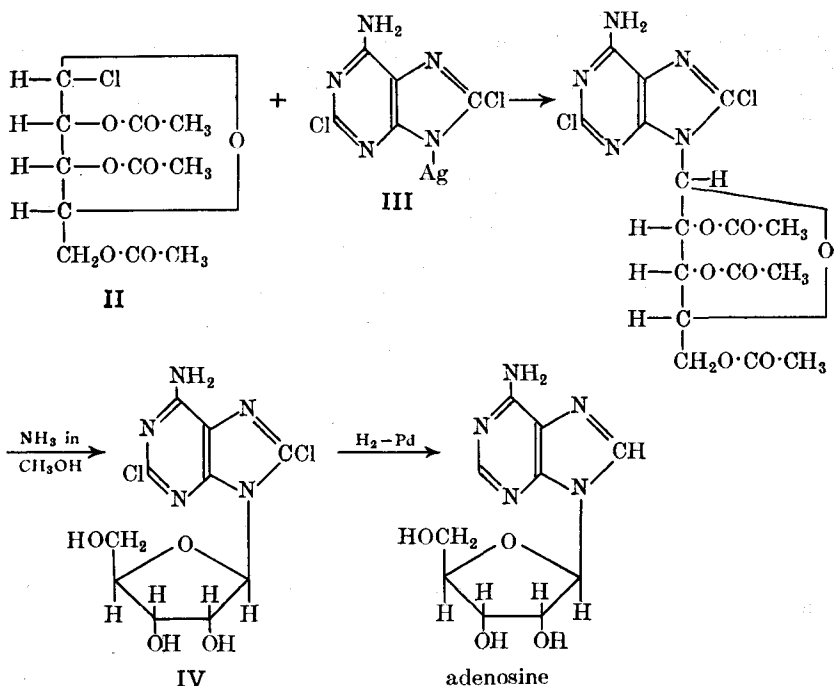

confirmed the  $\beta$ -configuration; *e.g.*, adenosine has been synthesised as follows (Todd *et al.*, 1948). Acetochloro-D-ribofuranose, II (*cf.* §24. VII), is condensed with the silver salt of 2:8-dichloroadenine, III, and the product deacetylated with a methanolic solution of ammonia to give 2:8-dichloro-9- $\beta$ -ribofuranosyladenine, IV. IV, on catalytic reduction (palladium), is converted into adenosine.

Furberg (1950) has shown by means of the X-ray analysis of cytidine that the sugar residue is attached to N<sub>3</sub> and is  $\beta$ -D-ribofuranoside. Since other ribonucleosides exhibit the same general pattern, it is inferred that all are furanosides with the  $\beta$ -configuration. Manson *et al.* (1951), from absorption spectra measurements, have shown that deoxyribonucleosides also exist in the  $\beta$ -configuration.

It will be noted from the foregoing account that the sugar residue is attached to a nitrogen atom in the base. Recently, however, Davis *et al.* (1957) and Cohn *et al.* (1959) have isolated a new nucleotide from, *e.g.*, yeast R.N.A., which is unique in that it appears to be a C-glycoside. This linkage in the nucleoside is *not* broken by acid, and the evidence obtained so far suggests the nucleoside has a 5-substituted uracil structure.

**§13d. Structure of nucleotides.** When nucleotides are carefully hydrolysed, ribose monophosphate may be isolated from the products; thus the phosphoric acid is attached to the sugar residue in nucleotides. Examination of the nucleoside structures shows that the point of attachment may be 2', 3' or 5' in the ribose molecule, and 3' or 5' in the deoxyribose molecule. On reduction with hydrogen in the presence of platinum, ribose phosphate is converted into an optically inactive phosphoribitol (Levene *et al.*, 1932, 1933). This product can be optically inactive only if the phosphate residue is attached to the *centre* hydroxyl group of the ribose molecule, *i.e.*, at the 3'-position.

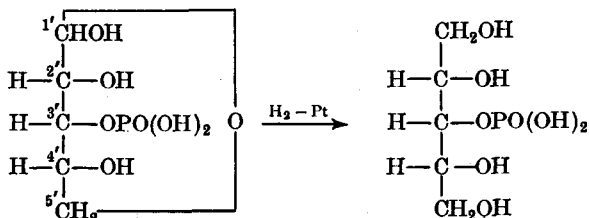

It should be remembered that the furanose structure occurs only when the sugar is in the form of a glycoside; on hydrolysis, the furanose sugar first liberated immediately changes into the stable pyranose form (see §7f. VII).

Until recently, it was believed that the 3'-position was the only one occupied by the phosphate radical. Emden *et al.* (1929) claimed to have isolated a 5'-phosphate (from muscle nucleic acid). Carter and Cohn (1949) isolated two isomeric adenylic acids from the alkaline hydrolysates of R.N.A.s, and called them "a" and "b" adenylic acids. These authors, in 1950, also isolated two isomers of guanylic, uridylic and cytidylic acids. Carter and Cohn found that one of their adenylic acids was identical with adenosine-3'-phosphate, but the other was not the same as the 5'-compound of Emden. These authors therefore believed that their two isomers were the 2'- and 3'-phosphate. Todd *et al.* (1952) synthesised adenosine-2'- and 3'-phosphate, and showed that their synthetic compounds were identical with the "a" and "b" acids obtained by Carter and Cohn, but were not able to say which was which. Loring *et al.* (1952) showed that the "a" and "b" cytidylic acids resist oxidation by periodic acid, and hence it follows that they must be the 2'- and 3'-phosphates (but there is no indication from this which isomer is the 2'- and which is the 3'-); had one isomer been the 5'-compound, then it would have been oxidised by periodic acid (the two hydroxyls on 2' and 3' are free and adjacent). A study of the solubility, acidity and absorption spectra of these two cytidylic acids led Loring *et al.* to suggest that the "a" acid is the 2'-phosphate. This conclusion has been supported by Harris *et al.* (1953) from their study of the infra-red spectra of these compounds. Todd *et al.* (1954) have synthesised deoxycytidine-3'-phosphate, and comparison of its infra-red spectra and other properties with cytidine phosphates provides strong evidence that "b" cytidylic acid is cytidine-3'-phosphate, and therefore that "b" uridylic acid is uridine-3'-phosphate. Brown *et al.* (1955) have shown that hydrazine splits "a" and "b" cytidylic acid to give ribose 2- and 3-phosphate respectively. "b" Uridylic acid yields the same ribose phosphate obtained from "b" cytidylic acid. Thus the "a" and "b" isomers of these nucleotides are the 2'- and 3'-phosphates, respectively, of the ribonucleosides.

Experiments using enzymic hydrolysis of nucleic acids have shown that these acids also contain 5'-phosphoester links. Cohn *et al.* (1951) have isolated the 5'-phosphates of adenosine, guanosine, uridine and cytidine. These authors have also shown that the nucleotides in calf thymus D.N.A. are 3'- and 5'-phosphates (position 2' is not possible since this is a CH<sub>2</sub> group).

Thus, according to the foregoing evidence, the phosphate radical can occupy the positions 2', 3' and 5' in ribonucleotides, and 3' and 5' in deoxyribonucleotides. These, however, by no means exhaust the possible positions of the phosphate radical. Todd *et al.* (1951) have identified cyclic nucleoside phosphates (2' : 3'-) from the enzymic hydrolysates of R.N.A.s. If these cyclic esters are actually present in nucleic acids, then the 2'- and 3'-phosphates obtained by hydrolysis may arise by the opening of the cyclic compound (either the 2'- or 3'-ester will be obtained). Todd *et al.* (1953)

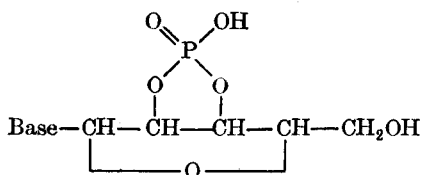

have also isolated thymidine-3' : 5'- diphosphate and deoxycytidine-3' : 5'- diphosphate from herring sperm deoxyribonucleic acid.

Heppel *et al.* (1955) have shown that these cyclic esters are converted into the 3'-phosphate in the presence of methanol or ethanol and ribonuclease provided the base is a cytosine or a uracil residue, *e.g.*,

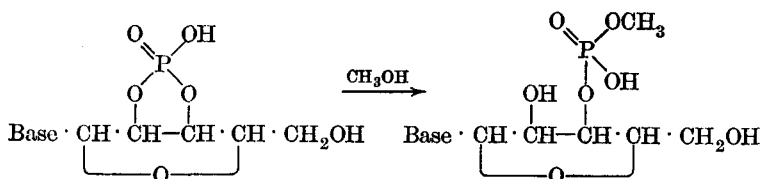

Barker *et al.* (1955) have shown that this reaction occurs only if the alcohol contains a primary alcoholic group, and suggest that if such a reaction is concerned in the biosynthesis of ribopolynucleotides from simpler units, then this requirement (*i.e.*, the primary alcoholic group) might explain why only, 3' : 5'-diester links are present in these polynucleotides (see §13e).

Nucleotides have been synthesised in various ways, *e.g.*, Levene *et al.* (1937) synthesised adenosine-5'-phosphate from 2',3'-*O*-isopropylideneadenosine. This was phosphorylated with phosphoryl chloride in pyridine, followed by careful hydrolysis with acid to remove the isopropylidene residue. 2'- and 3'-phosphates are more difficult to synthesise because of their ready interconversion. Todd *et al.* (1954) synthesised adenosine-2'-phosphate by phosphorylating 3',5'-di-*O*-acetyladenosine in the 2'-position with dibenzylphosphochloridate [(PhCH<sub>2</sub>O)<sub>2</sub>POCl] and removing the benzyl groups (as toluene) by hydrogenation (Pd), and finally removing the acetyl groups by treatment with alkali. Under these conditions no phosphate migration is possible.

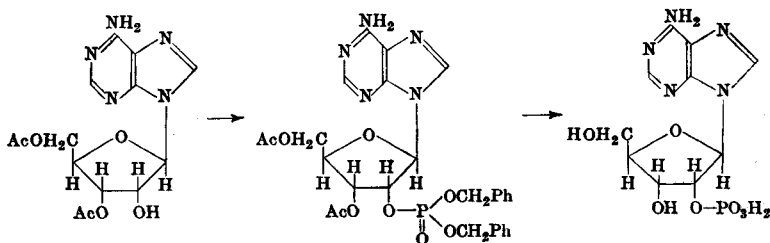

**§13e. Nucleic acids.** Having obtained evidence about the structure of nucleotides, we must now consider the problem concerning their linkage to form nucleic acids. In the early work, when a nucleic acid, obtained by drastic alkaline purification, was subjected to hydrolysis, the products were four molecules of phosphoric acid, four molecules of sugar, two purine molecules and two pyrimidine molecules, *e.g.*, yeast ribonucleic acid gave four molecules of phosphoric acid, four molecules of ribose and one molecule each of adenine, guanine, cytosine and uracil. On this and other evidence (see v below) Levene (1926) was led to propose the "tetranucleotide" theory, *e.g.* (R = ribose):

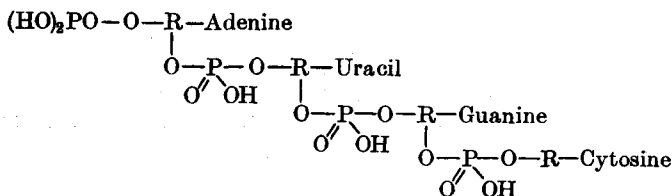

This simple structure for nucleic acids has, however, been shown to be incorrect by more recent work, *e.g.*,

(i) It has been found that alkaline methods of purification degrade nucleic acids; thus the molecular weight varies with the methods used for the isolation of the acid. Furthermore, fractionation experiments on both R.N.A.s and D.N.A.s (from the same and from different sources) have shown that these nucleic acids are complex mixtures (see also iv).

(ii) Various methods for determining molecular weights, *e.g.*, diffusion and the ultracentrifuge, have shown that the molecular weights of the nucleic acids are very high; they range from about  $10^5$  to  $10^7$ , *e.g.*, a value of about  $2 \times 10^6$  has been found for the R.N.A. from tobacco mosaic virus.

(iii) X-ray studies have shown that D.N.A.s are composed of two polynucleotide chains wound as spirals round a common axis but head in opposite directions (Wilkins *et al.*, 1953; Watson *et al.*, 1953). The two chains are held together by hydrogen bonds, thus producing a long, thin, relatively rigid molecule. Less is known about the structure of R.N.A.s, but according to Gierer (1957, 1958), the R.N.A. from tobacco mosaic virus is in the form of a flexible, moderately coiled chain.

(iv) The analysis of the hydrolysates of nucleic acids, particularly by chromatography, has shown that the acids from different sources have different chemical compositions (*cf.* i). According to Chargaff (1950), not one specimen of a nucleic acid gave analysis results corresponding to a tetranucleotide; thus the "statistical tetranucleotide" theory is untenable. Chargaff found that in D.N.A.s, the sum of the total purine nucleotides is equal to that of the pyrimidine nucleotides, and that the molar ratios of adenine to thymine, and of guanine to cytosine (or its analogues) are unity. Chargaff *et al.* (1954) also found the same regularities in R.N.A.s, with uracil taking the place of thymine. Chargaff estimated the nucleotide content from spectral data (as well as by some of the earlier methods), and pointed out that the regularities are not usually observed with *purified* samples of pentose nucleic acids, but only when, *e.g.*, whole cells are subjected to hydrolysis.

(v) Levene *et al.* (1926), from electromeric titration experiments, concluded that R.N.A.s show four primary and one secondary phosphate dissociation for each set of four phosphorus atoms present. On this evidence, and on the results of analysis, Levene put forward his tetranucleotide theory (see above). More refined titration experiments, however, have shown that R.N.A.s exhibit only three primary and one secondary phosphate dissociation (Gulland *et al.*, 1944). These latter findings are also supported by methylation experiments (Anderson *et al.*, 1949).

(vi) Various structures have been proposed for the nucleic acids, *e.g.*, Todd (1952) has suggested the following for deoxyribonucleic acids:

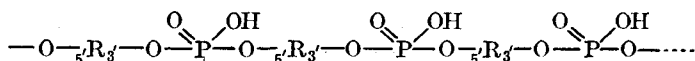

D.N.A.

The deoxyribose units are in the furanose form and attached to the phosphate molecule by the  $C_3'$  and  $C_5'$  hydroxyl groups; the base is attached to  $C_1'$  of the sugar. The structure of the R.N.A.s is less certain, but the linkages are believed to be similar to those of the D.N.A.s. All work so far reinforces Todd's suggestion that both types of nucleic acid are 3',5'-linked polynucleotides.

Since the nucleic acids are complex mixtures, the problem of determining nucleotide sequence is very difficult indeed. One method has been the use of enzymes, but used alone, this method has yielded little information. Enzymic methods, however, have been successful in synthesising large polynucleotides, *e.g.*, Kornberg *et al.* (1958) have carried the biosynthesis of D.N.A. by means of enzymes. On the other hand, chemical methods which have been developed are giving some information. The most thoroughly studied stepwise degradation method is the one which depends on the periodate oxidation of the 2',3'-glycol system in the terminal nucleoside residue of a polynucleotide chain (Todd *et al.*, 1953). This method may be used for R.N.A.s, but the absence of the 2'-hydroxyl group in D.N.A.s precludes its use for these acids.

Jones *et al.* (1956) have also developed a chemical method for the specific degradation of deoxyribonucleic acids. These authors have found that on treatment with mercaptoacetic acid ( $\text{CH}_2\text{SH}\cdot\text{CO}_2\text{H}$ ), purines are removed and replaced by carboxymethylthio groups. By this means it is possible to obtain information on the relative positions of purines and pyrimidines. Thus the results have shown that in calf-thymus deoxyribonucleic acids there are regions in which at least three pyrimidine nucleotides occur in adjacent positions.

A combination of enzymic and chemical methods appears to be the most successful technique. This type of approach was developed by Whitfield (1954) and has been improved by later workers (*inter alia*, Cohn *et al.*, 1961); the method can be applied to end-group analysis or to the analysis of short-chain fragments. Verwoerd *et al.* (1961) have introduced a method involving the use of hydroxylamine followed by enzymic treatment. The hydroxylamine displaces uracil and cytosine nuclei in the nucleic acid, and it has been shown that the enzyme (which normally hydrolyses the acid) does not break the chain at the sites where uracil has been removed.

#### READING REFERENCES

- Fischer, *Synthesen in der Puringruppe*, *Ber.*, 1899, **32**, 435.  
 Stewart, *Recent Advances in Organic Chemistry*, Longmans, Green. Vol. I (1931, 6th ed.). Ch. 13. The Purine Group.  
 Lythgoe, Some Aspects of Pyrimidine and Purine Chemistry, *Quart. Reviews (Chem. Soc.)*, 1949, **3**, 181.  
 Gilman (Ed.), *Advanced Organic Chemistry*, Wiley (1938, 1st ed.). Vol. II. Ch. 11. The Chemistry of Pyrimidines, Purines and Nucleic Acids.  
 Levene and Bass, *Nucleic Acids*, Chemical Catalogue Co. (1931).  
 Davidson, *The Biochemistry of the Nucleic Acids*, Methuen (1953, 2nd ed.).  
 Tipson, The Chemistry of the Nucleic Acids, *Advances in Carbohydrate Chemistry*, Academic Press, Vol. I (1945).  
 Schlenk, Chemistry and Enzymology of Nucleic Acids, *Advances in Enzymology*, Interscience Publishers, 1949, **9**, 455.  
 Rodd (Ed.), *Chemistry of Carbon Compounds*, Elsevier. Vol. IVC (1960). Ch. XX. Purines and Related Ring Systems. Ch. XXI. Nucleosides, Nucleotides and Nucleic Acids.  
 Avison and Hawkins, The Role of Phosphoric Esters in Biological Reactions, *Quart. Reviews (Chem. Soc.)*, 1951, **5**, 171.  
 Baddiley and Buchanan, Recent Developments in the Biochemistry of Nucleotide Coenzymes, *Quart. Reviews (Chem. Soc.)*, 1958, **12**, 152.  
 Fairley, Nucleic Acids, Genes, and Viruses, *J. Chem. Educ.*, 1959, **36**, 544.

- Roth, Ribonucleic Acid and Protein Synthesis, *J. Chem. Educ.*, 1961, **38**, 217.
- Todd, Some Current Problems in Polynucleotide Chemistry, *Proc. Chem. Soc.*, 1961, 187.
- Verwoerd *et al.*, Specific Partial Hydrolysis of Nucleic Acids in Nucleotide Sequence Studies, *Nature*, 1961, **192**, 1038.
- Spencer *et al.*, Determination of the Helical Configuration of Ribonucleic Acid Molecules by X-Ray Diffraction, *Nature*, 1962, **194**, 1014.

## CHAPTER XVII

### VITAMINS

**§1. Introduction.** In addition to oxygen, water, proteins, fats, carbohydrates and certain inorganic salts, a number of organic compounds are also necessary for the life, growth and health of animals (including man). These compounds are known as the "accessory dietary factors" or *vitamins*, and are only necessary in very small amounts. Vitamins cannot be produced by the body and hence must be supplied. Vitamin D, however, may be supplied in food or may be produced in the skin by irradiation (ultraviolet) of sterols.

Many vitamins have now been isolated and their structures elucidated. As each vitamin was isolated, it was named by a letter of the alphabet, but once its structure had been established (or almost established), the vitamin has generally been renamed (see text).

The vitamins have been arbitrarily classified into the "fat-soluble group" (vitamins A, D, E and K), and the "water-soluble group" (the remainder of the vitamins).

A number of vitamins have already been dealt with in various chapters dealing with natural products with which these particular vitamins are closely associated chemically, *viz.* vitamins A<sub>1</sub> and A<sub>2</sub> (§7. IX), vitamin C (§11. VII) and the vitamin D group (§§6, 6a, 6b. XI). This chapter is devoted to a number of other vitamins (see the reading references for further information).

From the point of view of chemical structure, there is very little common to the various vitamins, but from the point of view of chemical reactions, many of the water-soluble vitamins have one feature in common, and that is their ability to take part in reversible oxidation-reduction processes. Thus they form a part of various co-enzymes (see §17. XIII), *e.g.*, nicotinamide is present in co-enzyme I (diphosphopyridine nucleotide; DPN), and in co-enzyme II (triphosphopyridine nucleotide; TPN); phosphorylated pyridoxal is the co-enzyme of transaminases; riboflavin in flavin adenine nucleotide (FAD); pantothenic acid in co-enzyme A; etc.

### VITAMIN B COMPLEX

**§2. Introduction.** Eijkman (1897) found that birds developed polyneuritis when fed with polished rice, and were cured when they were given rice polishings. Then Grijns (1901) found that rice polishings cured beriberi in man (beriberi in man corresponds to polyneuritis in birds; it is a form of paralysis). Grijns suggested that the cause of this paralysis was due to some "deficiency" in the diet, and this was confirmed by Funk (1911, 1912), who prepared a concentrate of the active substance from rice polishings. Funk believed that this active substance was a definite chemical compound, and since he separated organic bases when he prepared his concentrate, he named his "deficiency compound" a *vitamine*. It was then found that "vitamine B" was a complex mixture, and when a number of "vitamines" were obtained that contained no nitrogen, the name *vitamin* was retained for them. The name vitamin B is now reserved for the complex mixture of vitamins in this group.



**§3. Vitamin B<sub>1</sub>, thiamine (aneurin).** Thiamine is one member of the water-soluble vitamin B complex, and is in the thermolabile fraction; it is the absence of thiamine which is the cause of beriberi in man; thus this vitamin is the antineuritic factor (hence the name *aneurin*). Rice polishings and yeast have been the usual sources of thiamine; eggs are also a rich source.

Thiamine is obtained crystalline in the form of its salts; the chloride hydrochloride has been shown to have the molecular formula  $C_{12}H_{18}ON_4Cl_2S$  (Windaus *et al.*, 1932); this salt is isolated in the form of its hemihydrate, d. 248–250°. When treated with a sodium sulphite solution saturated with sulphur dioxide at room temperature, thiamine is decomposed quantitatively into two compounds which, for convenience, we shall label A and B (R. R. Williams *et al.*, 1935).

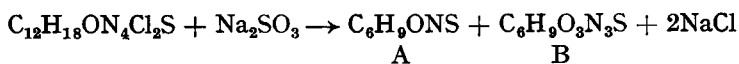

**Compound A,  $C_6H_9ONS$ .** This compound shows basic properties, and since it does not react with nitrous acid, it was inferred that the nitrogen atom is in the tertiary state. The functional nature of the oxygen atom was shown to be alcoholic, *e.g.*, when A is treated with hydrochloric acid, a hydroxyl group (one oxygen atom and one hydrogen atom) is replaced by a chlorine atom. Furthermore, since the absorption spectrum of the chloro derivative is almost the same as that of the parent (hydroxy) compound, this suggests that the hydroxyl group is in a side-chain. The sulphur did not give the reactions of a mercapto compound nor of a sulphide; in fact, the stability (*i.e.*, unreactivity) of this sulphur atom led to the suggestion that it was in a heterocyclic ring. This conclusion was confirmed by the fact that A has an absorption spectrum characteristic of a thiazole (§5. XII).

R. R. Williams *et al.* (1935) found that oxidation of A with nitric acid gives the compound  $C_5H_5O_2NS$ , which can also be obtained by the direct oxidation of thiamine with nitric acid. This latter reaction had actually been carried out by Windaus *et al.* (1934), but these workers had not recognised the presence of the thiazole nucleus. Williams *et al.* showed that this oxidation product was a monocarboxylic acid, and found that it was identical with 4-methylthiazole-5-carboxylic acid, I, a compound already described in the literature (Wöhmann, 1890). From this it follows that A has a side-chain of two carbon atoms in place of the carboxyl group in I

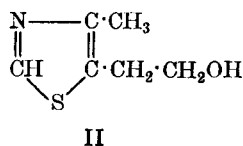
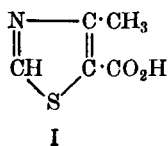

(one carbon atom is lost when A is oxidised to I). Since it is this side-chain which must contain the alcoholic group, the side-chain could be either  $-\text{CH}_2 \cdot \text{CH}_2\text{OH}$  or  $-\text{CHOH} \cdot \text{CH}_3$ . Either of these could lose a carbon atom to form a carboxyl group directly attached to the thiazole nucleus. The second alternative,  $-\text{CHOH} \cdot \text{CH}_3$ , was excluded by the fact that A does not give the iodoform test, and that A is not optically active (the second alternative contains an asymmetric carbon atom). Thus A was given structure II, and this has been confirmed by synthesis (Clarke *et al.*, 1935).

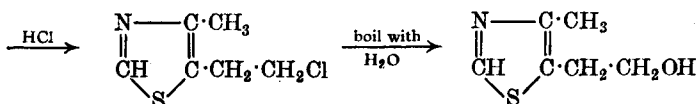
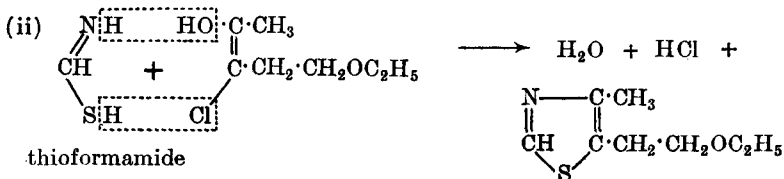
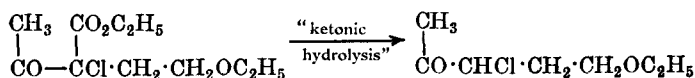
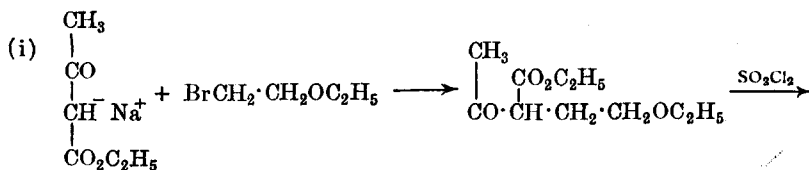

A

The hydrochloride of this compound is identical with that of the product obtained from thiamine (by fission), and also gives I on oxidation with nitric acid.

Londergan *et al.* (1953) have synthesised A from 2-methylfuran as follows:

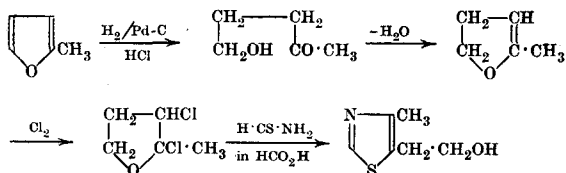

**Compound B**,  $\text{C}_6\text{H}_9\text{O}_3\text{N}_3\text{S}$ . This was shown to be a sulphonic acid, *e.g.*, when heated with water under pressure at  $200^\circ$ , B gives sulphuric acid; it also forms sodium sulphite when heated with concentrated sodium hydroxide solution. On treatment with nitrous acid, B evolves nitrogen; thus B contains one or more amino-groups. Analysis of the product showed that one amino-group is present in B (the product contained only one hydroxyl group). Furthermore, since the evolution of nitrogen was slow, and the reaction of B with benzoyl chloride was also slow, this suggests that B contains an amidine structure (Williams *et al.*, 1935). Williams *et al.* (1935) then heated B with hydrochloric acid at  $150^\circ$  under pressure, and obtained

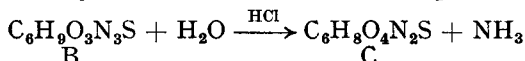

compound C and ammonia. The formation of ammonia indicates the replacement of an amino-group by a hydroxyl group. This type of reaction is characteristic of 2- and 6-aminopyrimidines; it was therefore inferred that B is a pyrimidine derivative (*cf.* §14. XII). This is supported by the fact that the ultraviolet absorption spectrum of compound C was similar to that of synthetic 6-hydroxypyrimidines; thus B is probably a 6-aminopyrimidine.

When B is reduced with sodium in liquid ammonia, a sulphonic acid group is eliminated with the formation of an aminodimethylpyrimidine (Williams, 1936). Comparison of the ultraviolet absorption spectrum of this product with various synthetic compounds showed that it was 6-amino-2:5-dimethylpyrimidine, and this was confirmed by synthesis (Williams *et al.*, 1937).

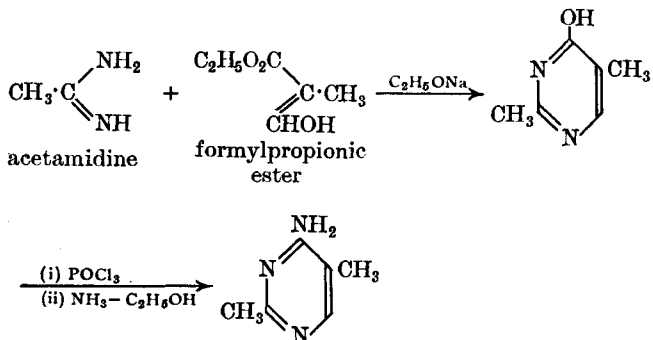

Thus B is 6-amino-2:5-dimethylpyrimidine with one hydrogen atom (other than one of the amino-group) replaced by a sulphonic acid group. When thiamine is treated with sodium in liquid ammonia, one of the products is the diamino derivative D,  $\text{C}_8\text{H}_{10}\text{N}_4$  (Williams *et al.*, 1937). Compound D was identified as 6-amino-5-aminomethyl-2-methylpyrimidine by comparison

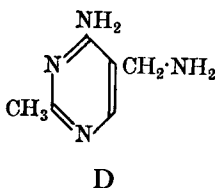

with the absorption spectra of methylated aminopyrimidines of known structure (Williams *et al.*, 1937). This is confirmed by the synthesis of Grewe (1936); Williams *et al.* had arrived at their conclusion independently of Grewe's work (see below for this synthesis). Thus, in compound D, there is an amino-group instead of the sulphonic acid group in B. Williams therefore concluded that the sulphonic acid group (in B) is joined to the methyl group at position 5. This was confirmed (in 1937) by treating 5-ethoxymethyl-6-hydroxy-2-methylpyrimidine (see the synthesis described for thiamine) with sodium sulphite, whereby 6-hydroxy-2-methylpyrimidyl-5-methanesulphonic acid was obtained, and this was shown to be identical with compound C.

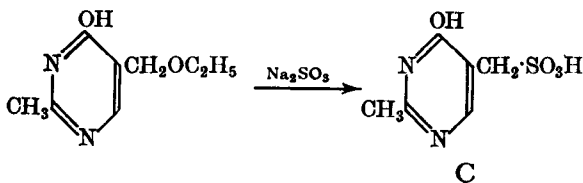

Thus B has the following structure:

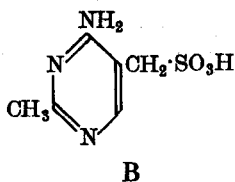

This structure is confirmed by synthesis (Grewe, 1936; Andersag *et al.*, 1937).

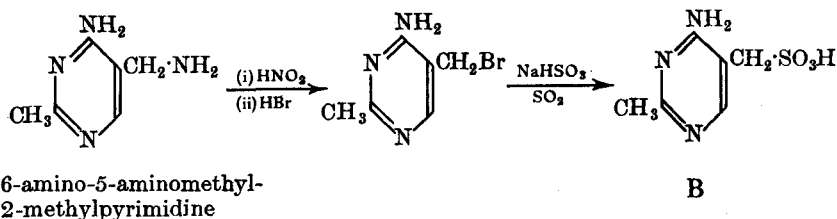
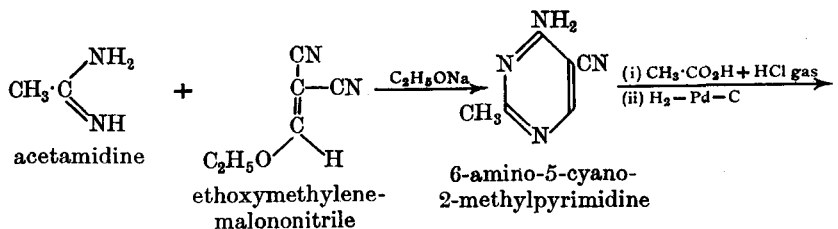

The final problem is: How are fragments A and B united in thiamine? As we have seen, the sulphonic acid group in B is introduced during the fission of thiamine with sodium sulphite; thus the point of attachment of fragment B is at the  $\text{CH}_2$  group at position 5. To account for the formation of compound D, fragment B must be linked to the nitrogen atom of fragment A; in this position, the nitrogen atom of the thiazole ring is in a quaternary state, and so accounts for the chloride hydrochloride of thiamine. Had B been connected to A through a carbon atom of the latter, it would not be easy to account for the ready fission of this carbon-carbon bond by means of sodium and liquid ammonia, nor for the fact that thiamine does not form a *dihydrochloride*. Thus the chloride hydrochloride of thiamine is

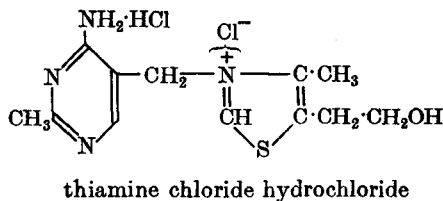

This structure has been confirmed by synthesis, *e.g.*, that of Williams *et al.* (1936, 1937).

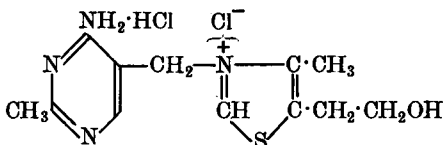
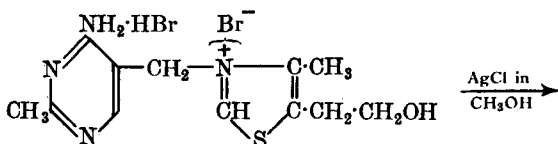
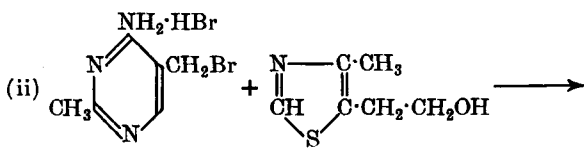
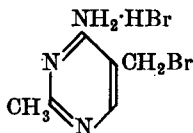
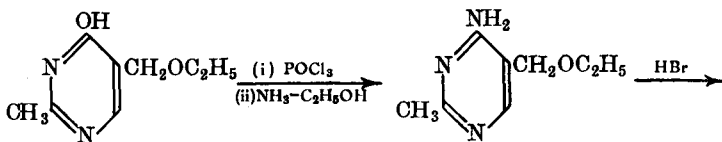
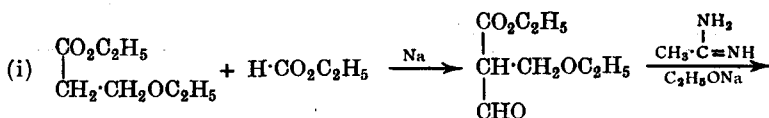

§4. **Co-carboxylase.** This is the co-enzyme of *carboxylase*, and has been shown to be the pyrophosphate of thiamine (Lohmann *et al.*, 1937). Carboxylase, which requires the co-enzyme for action (see §15. XIII), breaks down pyruvic acid, formed in alcoholic fermentation, to acetaldehyde and carbon dioxide.

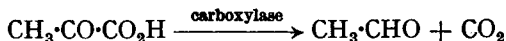

Co-carboxylase is

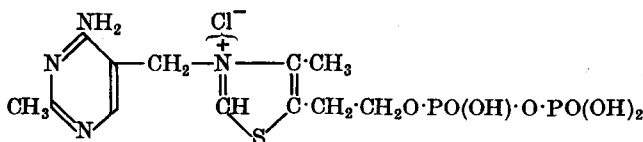

§5. **Thiochrome** was isolated from yeast by Kuhn *et al.* (1935); it is a yellow basic solid and its solutions show a blue fluorescence. Thiochrome

is also formed by the oxidation of thiamine with alkaline potassium ferricyanide (Todd *et al.*, 1935); it has also been synthesised by Todd *et al.* (1936).

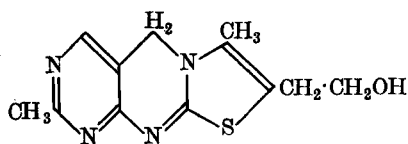

thiochrome

§6. **Vitamin B<sub>2</sub>, riboflavin (lactoflavin)**, C<sub>17</sub>H<sub>20</sub>O<sub>6</sub>N<sub>4</sub>. Riboflavin is a water-soluble, thermostable vitamin which occurs in the vitamin B complex. It is necessary for growth and health, and occurs widely distributed in nature, *e.g.*, in yeast, green vegetables, milk, meat, etc. Chemically, vitamin B<sub>2</sub> is closely related to the yellow water-soluble pigments known as the *flavins* (*isalloxazines*), and since it was first isolated from milk, vitamin B<sub>2</sub> is also known as *lactoflavin*.

Riboflavin is a bright yellow powder, m.p. 292°, showing a green fluorescence; it is soluble in water and in ethanol, but is insoluble in chloroform and other organic solvents.

When exposed to light, lactoflavin in sodium hydroxide solution forms mainly lumi-lactoflavin, C<sub>13</sub>H<sub>12</sub>O<sub>2</sub>N<sub>4</sub> (this is soluble in chloroform). Lumi-lactoflavin, on boiling with barium hydroxide solution, is hydrolysed to one molecule of urea and one molecule of the barium salt of a  $\beta$ -ketocarboxylic acid, I, C<sub>12</sub>H<sub>12</sub>O<sub>3</sub>N<sub>2</sub> (Kuhn *et al.*, 1933, 1934). The nature of this acid is shown by the fact that, on acidification of the barium salt, the free acid immediately eliminates carbon dioxide to form the compound, II, C<sub>11</sub>H<sub>12</sub>ON<sub>2</sub>. This compound showed the properties of a lactam, and on vigorous hydrolysis by boiling with sodium hydroxide solution, it forms one molecule of glyoxylic acid and one molecule of the compound C<sub>9</sub>H<sub>14</sub>N<sub>2</sub> (III).

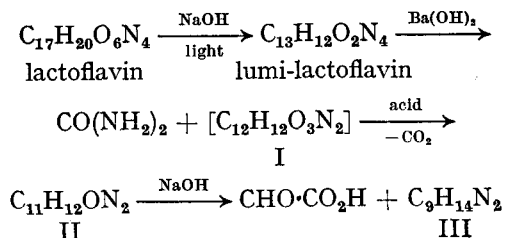

The structure of III was elucidated as follows (Kuhn *et al.*, 1934). Preliminary tests showed that III was an aromatic diamino compound. Then it was found that it gave a blue precipitate with ferric chloride, and since this reaction is characteristic of monomethyl-*o*-phenylenediamine, it suggests that III contains the following nucleus, IV. The molecular formula of IV is C<sub>7</sub>H<sub>10</sub>N<sub>2</sub>, and since III is C<sub>9</sub>H<sub>14</sub>N<sub>2</sub>, two carbon and four hydrogen atoms

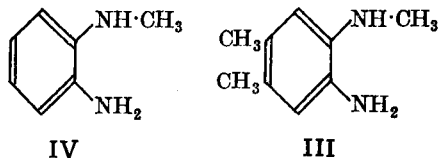

must be accounted for. This can be done by assuming the presence of an ethyl group or of two methyl groups in the benzene ring. Kuhn *et al.*

carried out a series of synthetic experiments and showed that III has the structure given, *N*-methyl-4 : 5-diamino-*o*-xylene. Kuhn then proposed II as the structure of the precursor of III, since this would produce the required products of hydrolysis.

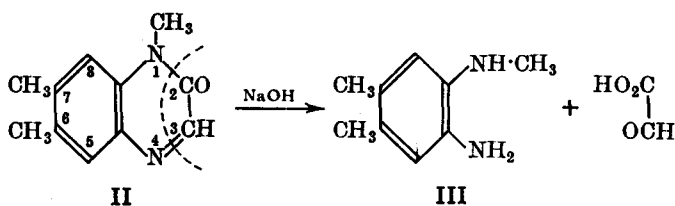

II could therefore have been produced from the  $\beta$ -ketocarboxylic acid I

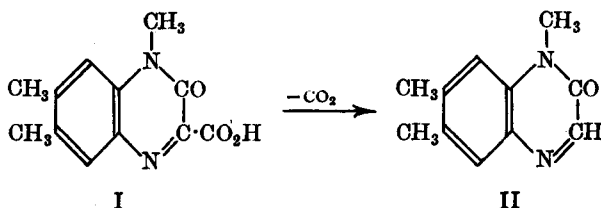

Since I and a molecule of urea are obtained from lumi-lactoflavin, the latter could be 6 : 7 : 9-trimethylisoalloxazine (6 : 7 : 9-trimethylflavin).

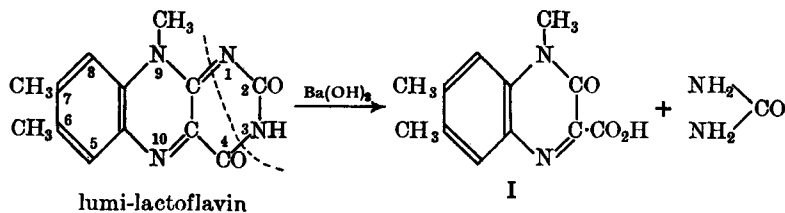

This structure for lumi-lactoflavin has been confirmed by synthesis (Kuhn *et al.*, 1934). *N*-Methyl-4 : 5-diamino-*o*-xylene is condensed with alloxan hydrate (§2. XVI) in aqueous solution at 50–60°.

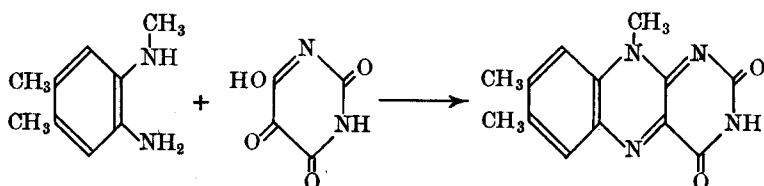

Methylation (methyl sulphate) of this synthetic product gives a tetramethyl compound identical with the product obtained by the methylation of the natural lumi-lactoflavin.

#### Side-chain of lactoflavin

Exposure of a neutral solution of lactoflavin to light produces *lumichrome*,  $\text{C}_{12}\text{H}_{10}\text{O}_3\text{N}_4$  (Karrer *et al.*, 1934). Analytical work similar to that described for lumi-lactoflavin showed that the structure of lumichrome is 6 : 7-dimethylalloxazine (A).

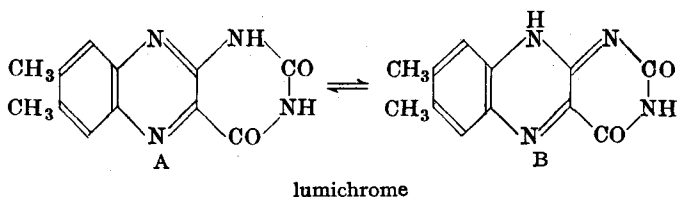

The *isoalloxazine* (structure B) is a tautomer of the *alloxazine* (structure A); B does not exist as such, but this structure is fixed when there is a substituent at position 9 (see also §25. XII). Stern *et al.* (1934) have shown that the absorption spectra of compounds containing a 9-substituent are different from those in which the mobile 9-hydrogen atom is present. Also, in the latter case, the *alloxazine* structure (A) predominates.

Thus lumichrome is *lumi-lactoflavin* with a hydrogen atom instead of a methyl group at position 9. This suggests that *lactoflavin* contains a side-chain (of five carbon atoms) attached to N<sub>9</sub>. The Zerewitinoff procedure shows that *lactoflavin* contains five active hydrogen atoms; thus the molecule contains four hydroxyl groups (one active hydrogen atom is the hydrogen of the NH group at position 3). The presence of these four hydroxyl groups is supported by the fact that the silver salt of *lactoflavin* (the silver atom replaces the hydrogen of the NH group) forms a tetra-acetate. Thus the side-chain is a tetra-hydroxy derivative, and so a possible structure for *lactoflavin* is:

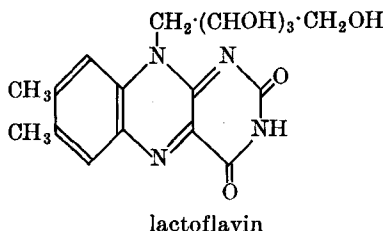

This side-chain contains three asymmetric carbon atoms, and so there are eight optically active forms possible. Which configuration is actually present was solved by synthesising a number of pentose derivatives, and it was finally shown by Karrer *et al.* (1935) that the configuration is that of D(-)-ribose. The following syntheses are due to Karrer *et al.* (1935).

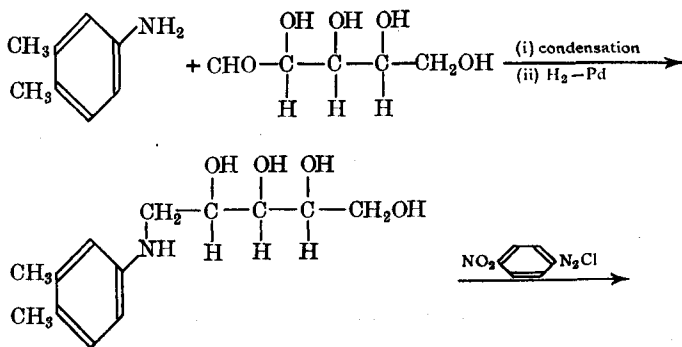



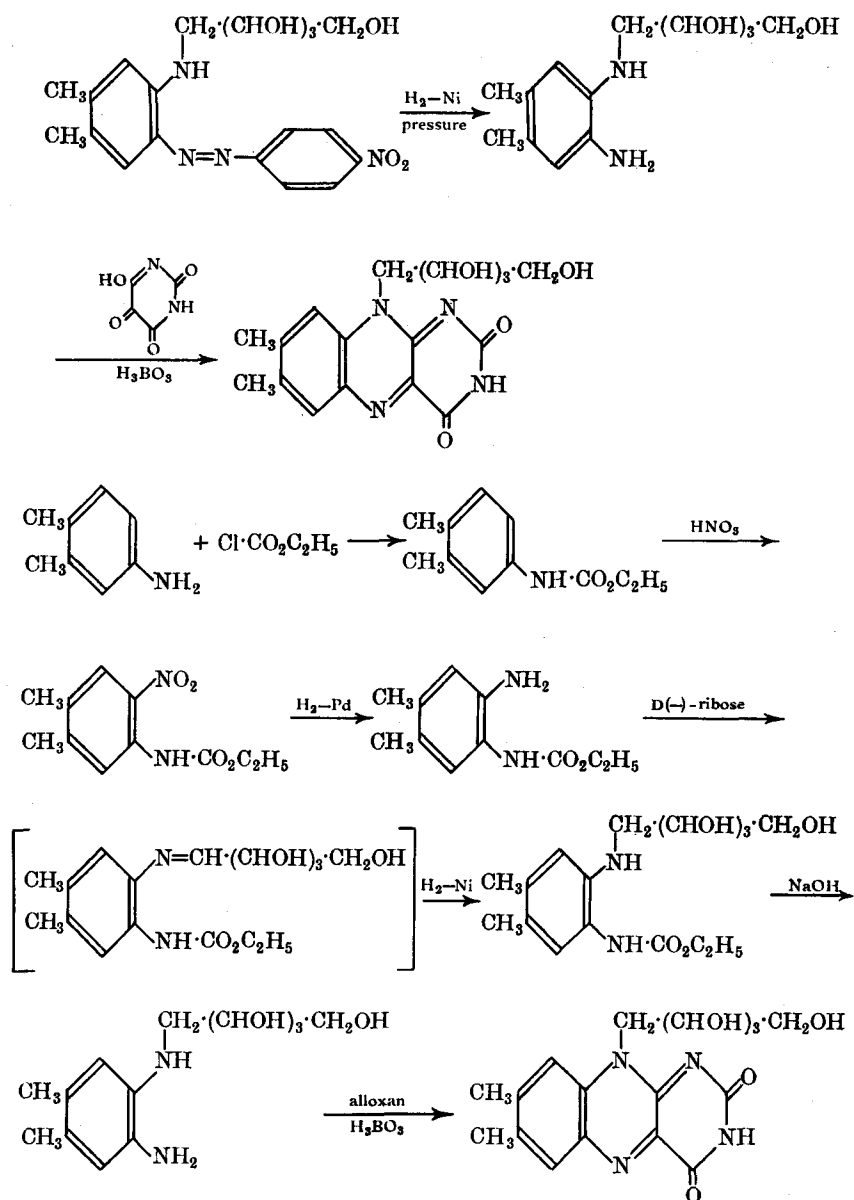

Thus lactoflavin is 6 : 7-dimethyl-9-[D-1'-ribityl]-isoalloxazine. Of all the pentoses (and hexoses) used, only the compound from D-ribose shows growth-promoting properties. For this reason vitamin  $\text{B}_2$  (lactoflavin) is also known as riboflavin. More recently, however, it has been found that L-lyxoflavin occurs naturally; it has been synthesised and shows some vitamin activity (Folkers *et al.*, 1951).

Biosynthetic experiments have established that riboflavin is formed from purine precursors (McNutt, 1954, 1956; Goodwin *et al.*, 1954; Plaut *et al.*, 1959). It has also been shown that the dimethylbenzene system is derived from acetate

units (Plaut, 1954; Birch *et al.*, 1957; Goodwin *et al.*, 1958). Cresswell and Wood (1960) have synthesised riboflavin by a method which has possible implications in the biosynthesis of this vitamin.

§7. **Pantothenic acid**,  $C_9H_{17}O_5N$ , is a chick antidermatitis factor, and is also capable of promoting the growth of yeast and of bacteria; it has been isolated from many sources, *e.g.*, liver, kidney, yeast, etc.

Pantothenic acid shows the reactions of a monocarboxylic acid, *e.g.*, it can be esterified to form monoesters (R. J. Williams *et al.*, 1939). The application of the method for determining active hydrogen atoms shows that pantothenic acid contains two hydroxyl groups, and since the acid condenses with benzaldehyde (to form a benzylidene derivative) and with acetone (to form an *isopropylidene* derivative), this suggests that the two hydroxy groups are in either the 1:2- or 1:3-position (*cf.* §§8, 9. VII). When warmed with dilute hydrochloric acid, pantothenic acid is hydrolysed into compounds I and II. Investigation of I showed that it was  $\beta$ -alanine

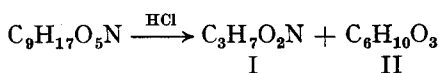

(actually present as the hydrochloride,  $\bar{Cl}\{H_3\overset{\oplus}{N}\cdot CH_2\cdot CH_2\cdot CO_2H\}$ ). On the other hand, when hydrolysed with alkali, pantothenic acid forms  $\beta$ -alanine (I) and the salt of an acid which, on acidification, spontaneously forms the lactone II. Thus the free acid of II is probably a  $\gamma$ - or  $\delta$ -hydroxycarboxylic acid; also, since the rate of lactonisation is fast, II is more likely a  $\gamma$ -lactone than a  $\delta$ -lactone (*cf.* §7c. VII). As pointed out above, pantothenic acid contains two hydroxyl groups. One of these has now been accounted for, and so the problem is to find the position of the second one. This was shown to be  $\alpha$ - by the fact that the sodium salt of the acid of the lactone II gives a canary-yellow colour with ferric chloride (a test characteristic of  $\alpha$ -hydroxyacids), and also by the fact that II, on warming with concentrated sulphuric acid, liberates carbon monoxide (a test also characteristic of  $\alpha$ -hydroxyacids). Thus II is most probably the  $\gamma$ -lactone of an  $\alpha$ -hydroxyacid (R. J. Williams *et al.*, 1940).

II was shown to contain one active hydrogen atom, and the application of the Kuhn-Roth methyl side-chain determination (§3. IX) showed the presence of a *gem*-dimethyl group (Stiller *et al.*, 1940); the presence of this group is confirmed by the formation of acetone when the lactone II is oxidised with barium permanganate. Thus a possible structure for II is  $\alpha$ -hydroxy- $\beta$ : $\beta$ -dimethyl- $\gamma$ -butyrolactone:

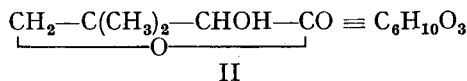

This has been confirmed as follows. Treatment of the lactone with methylmagnesium iodide, followed by hydrolysis, gives a trihydric alcohol which, on oxidation with lead tetra-acetate, gives acetone and an aldehyde. This aldehyde, on oxidation with silver oxide, gave a compound III, which was shown to be  $\beta$ -hydroxy- $\alpha$ : $\alpha$ -dimethylpropionic acid. The foregoing reactions may be formulated as follows:

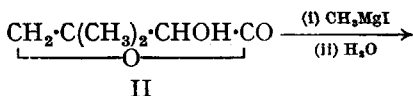

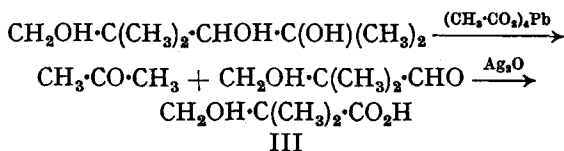

Examination of II shows that it contains one asymmetric carbon atom. The lactone, **pantolactone** (the acid is known as **pantoic acid**), obtained from pantothenic acid is lævorotatory, and the structure assigned to it has been confirmed by synthesis (Stiller *et al.*, 1940).

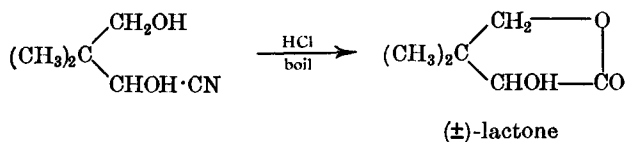
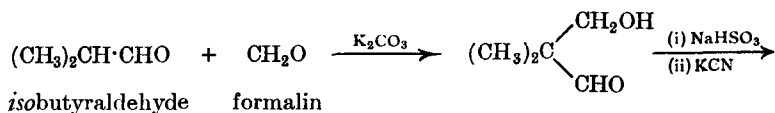

The ( $\pm$ )-lactone (as the sodium salt of the acid) was resolved with quinine hydrochloride, and the (–)-form was identical with the lactone obtained from pantothenic acid.

In pantothenic acid, the nitrogen atom is not basic. Also, since hydrolysis of pantothenic acid produces a free amino-group (in  $\beta$ -alanine), this suggests that the group  $-\text{CO}\cdot\text{NH}-$  is present, *i.e.*, pantothenic acid is an amide. Thus the hydrolysis may be formulated:

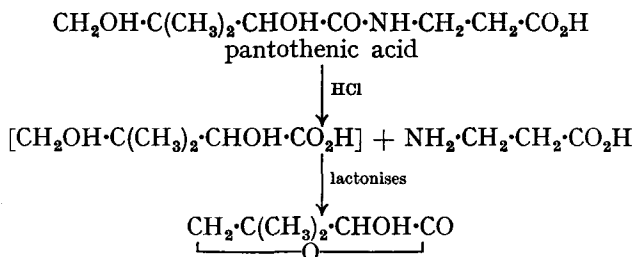

This interpretation of the results has been proved by the synthesis of pantothenic acid. Stiller *et al.* (1940) warmed pantolactone (synthesised as described above) with the ethyl ester of  $\beta$ -alanine, and removed the ester group by hydrolysis with a cold solution of barium hydroxide.

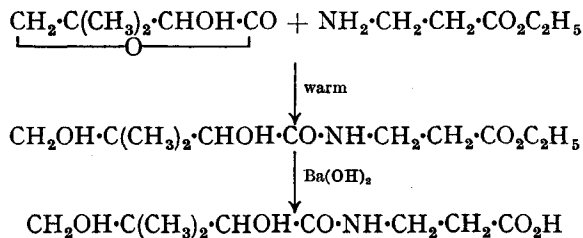

A better yield of pantothenic acid is obtained by warming the dry lactone with the dry sodium salt of  $\beta$ -alanine (R. J. Williams *et al.*, 1940).

**§8. Folic acid complex.** A number of micro-organisms need certain concentrates (prepared from natural sources) for growth; several active principles have been shown to be necessary. In addition to the above property, some of these active principles also exhibit other effects, *e.g.*, the prevention of certain types of anæmia in chicks. The following compounds have been described as constituents of the folic acid complex.

(i) Folic acid. It has been suggested that folic acid from animal sources is different from that from vegetable sources.

(ii) *Lactobacillus casei* factor (three forms).

(iii) *S. lactis* R factor.

(iv) Vitamin B<sub>6</sub> factor (this now identified as liver *L. casei* factor).

(v) Vitamin B<sub>6</sub> conjugate.

(vi) Vitamins B<sub>10</sub>, B<sub>11</sub> and factors R, S and U.

(vii) Vitamin M.

It is possible that some of these are identical; names have been given by different workers to the active substances that they have isolated (see, *e.g.*, iv).

Angier *et al.* (1946) have shown that liver *L. casei* factor (also called vitamin B<sub>6</sub>) is:

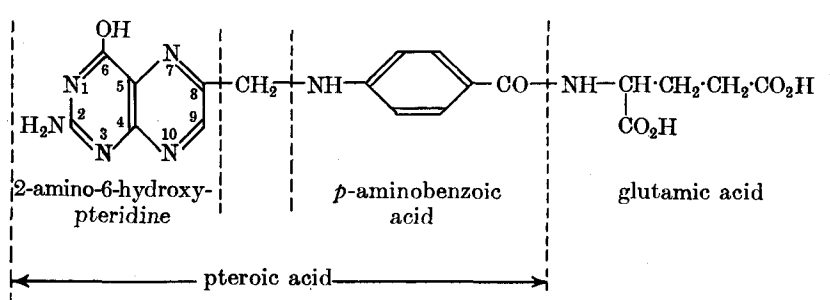

Fermentation *L. casei* factor contains three glutamic acid residues; yeast vitamin B<sub>6</sub> conjugate contains seven glutamic acid residues.

**§8a. Structure of *L. casei* factors** (Angier *et al.*, 1946). The alkaline hydrolysis of the fermentation *L. casei* factor, in the absence of oxygen, formed two molecules of D-glutamic acid and the DL-form of liver *L. casei* factor. On the other hand, the alkaline hydrolysis of the fermentation *L. casei* factor, in the presence of air, gave two substances, I and II. I was

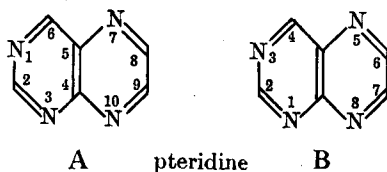

shown to be a monocarboxylic acid, and the examination of its ultraviolet absorption spectrum led to the conclusion that it was a pteridine derivative (A is the system of numbering used here; B is an alternative system of

numbering frequently used in American publications). A further examination of compound I showed that it also contained one hydroxyl and one amino-group. Oxidation of I with chlorine water, followed by hydrolysis with hydrochloric acid, produced guanidine,  $\text{NH}=\text{C}(\text{NH}_2)_2$ , as one of the products. The formation of this compound suggests that the amino-group is at position 2. Finally, I was shown to be 2-amino-6-hydroxypteridine-8-carboxylic acid by synthesis.

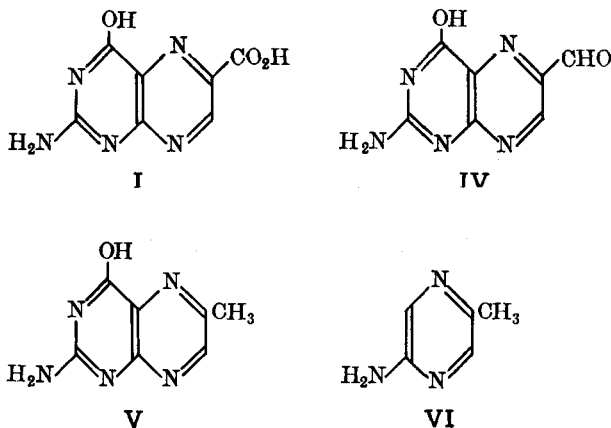

The reactions of compound II showed that it was a primary aromatic amine, and on hydrolysis it gave one molecule of *p*-aminobenzoic acid and three molecules of glutamic acid.

Hydrolysis of the fermentation *L. casei* factor with sulphurous acid gave an aromatic amine, III, and an aldehyde, IV. III, on hydrolysis, gave one molecule of *p*-aminobenzoic acid and three molecules of glutamic acid, *i.e.*, II and III are identical. When the aldehyde IV was allowed to stand in dilute sodium hydroxide solution in the absence of air, compound I and another compound, V, were produced. V, on vigorous hydrolysis, gave 2-amino-5-methylpyrazine, VI. From this it was concluded that V is 2-amino-5-methylpyrazine, and IV is 2-amino-6-hydroxypteridine-8-aldehyde. Consideration of this evidence led to the suggestion that the liver *L. casei* factor has the structure given in §8; this has been confirmed by synthesis, *e.g.*, that of Angier *et al.* (1946).

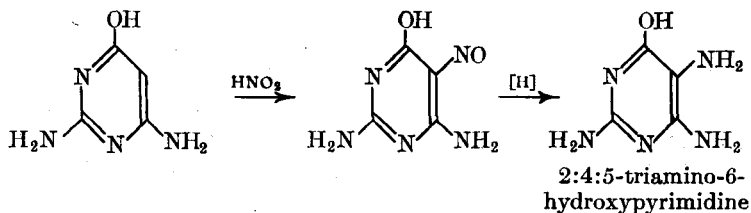
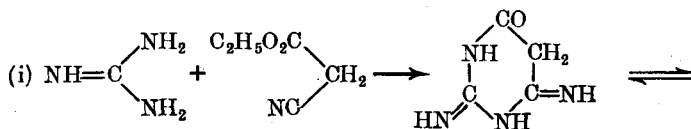

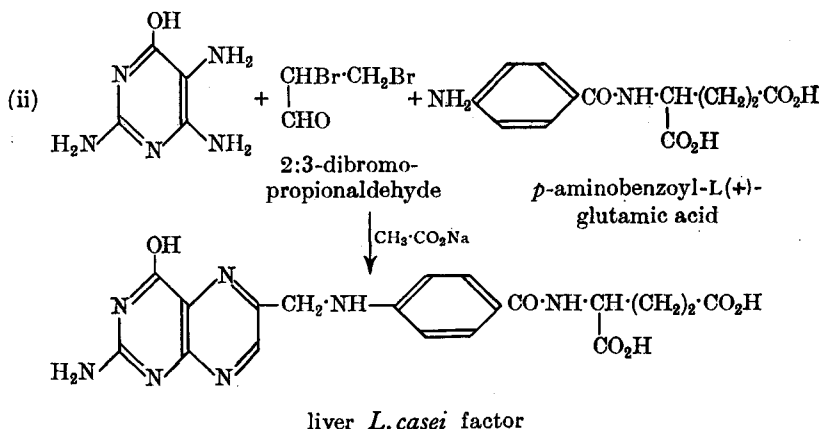

It might be noted, in passing, that the **pterins** are pigments of butterfly wings, wasps, etc.; they were first isolated from butterfly wings.

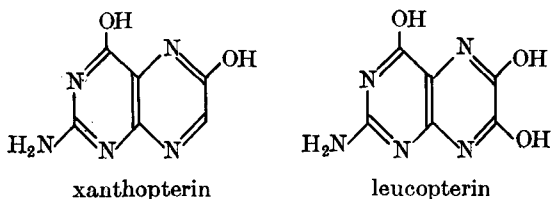

§9. **Biotins** (vitamin H). Bios, an extract of yeast, was shown to be necessary for the growth of yeast (Wildiers, 1901). It was then found that bios consisted of at least two substances (Fulmer *et al.*, 1922), and two years later, Miller showed that three substances were present in bios. The first of these was named Bios I, and was shown to be *mesoinositol* (Eastcott, 1928; see also §13). The second constituent, named Bios IIA, was then shown to be  $\beta$ -alanine (Miller, 1936) or pantothenic acid (Rainbow *et al.*, 1939). The third substance, named Bios IIB, was found to be identical with *biotin*, a substance that had been isolated by Kögl *et al.* (1936) as the methyl ester from egg-yolk. Subsequently other factors present in bios have been isolated, *e.g.*, pyridoxin (see §10) and nicotinic acid (§11).

Biotin is a vitamin, being necessary for the growth of animals. In 1940, du Vigneaud *et al.* isolated from liver a substance which had the same biological properties as biotin. Kögl *et al.* (1943) named their extract from egg-yolk  $\alpha$ -biotin, and that from liver  $\beta$ -biotin. Both compounds have the same molecular formula  $C_{10}H_{16}O_3N_2S$ .

**$\beta$ -Biotin** (Bios IIB or biotin), m.p. 230–232°, behaves as a saturated compound (the usual tests showed the absence of an ethylenic double bond).  $\beta$ -Biotin forms a monomethyl ester  $C_{11}H_{18}O_3N_2S$  which, on hydrolysis, gives an acid the titration curve of which corresponds to a monocarboxylic acid; thus the formula of  $\beta$ -biotin may be written  $C_9H_{15}ON_2S \cdot CO_2H$ . When heated with barium hydroxide solution at 140°,  $\beta$ -biotin is hydrolysed to carbon dioxide and diaminocarboxylic acid  $C_9H_{18}O_2N_2S$  which, by the action of carbonyl chloride, is reconverted into  $\beta$ -biotin (du Vigneaud *et al.*, 1941). These reactions suggest that  $\beta$ -biotin contains a cyclic ureide structure. Furthermore, since the diaminocarboxylic acid condenses with phenanthraquinone to form a quinoxaline derivative, it follows that the two amino-

groups are in the 1:2-positions (*cf.* §19. XII), and thus the cyclic ureide is five-membered. Hence we may write the foregoing reactions as follows:

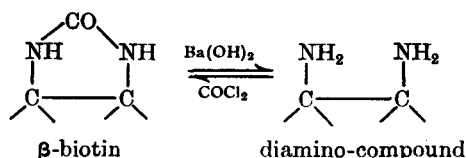

When this diaminocarboxylic acid is oxidised with alkaline permanganate, adipic acid is produced (du Vigneaud *et al.*, 1941). One of the carboxyl groups in adipic acid was shown to be that originally present in  $\beta$ -biotin as follows. When the carbomethoxyl group of the methyl ester of  $\beta$ -biotin was replaced by an amino-group by means of the Curtius reaction (ester  $\rightarrow$  hydrazide  $\rightarrow$  azide  $\rightarrow$  urethan  $\rightarrow$   $\text{NH}_2$ ; see Vol. I), and the product hydrolysed with barium hydroxide solution, a triamine was obtained which did not give adipic acid on oxidation with alkaline permanganate (du Vigneaud *et al.*, 1941, 1942). It was therefore inferred that  $\beta$ -biotin contains a  $-(\text{CH}_2)_4\text{CO}_2\text{H}$  side-chain (*n*-valeric acid side-chain).

The absorption spectrum of the quinoxaline derivative (formed from phenanthraquinone and the diaminocarboxylic acid) showed that it was a quinoxaline, I, and not a dihydroquinoxaline, II; thus the diaminocarboxylic could be III but not IV.

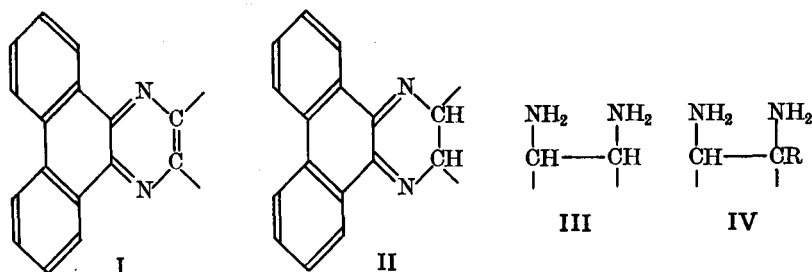

It therefore follows that the *n*-valeric acid side-chain cannot be attached to a carbon atom joined to an amino-group.

The nature of the sulphur atom in  $\beta$ -biotin was shown to be of the thio-ether type (*i.e.*, C—S—C) since:

- (i) Oxidation of  $\beta$ -biotin with hydrogen peroxide produced a sulphone.
- (ii) When the methyl ester of  $\beta$ -biotin was treated with methyl iodide, a sulphonium iodide was formed.

As we have seen,  $\beta$ -biotin does not contain a double bond; hence, from its molecular formula, it was deduced that  $\beta$ -biotin contains two rings (du Vigneaud *et al.*, 1941; Kögl *et al.*, 1941). The sort of argument that may be used is as follows. The molecular formula of  $\beta$ -biotin is  $\text{C}_{10}\text{H}_{16}\text{O}_3\text{N}_2\text{S}$ . The carboxyl group may be regarded as a substituent group, and so the parent compound will be  $\text{C}_9\text{H}_{16}\text{ON}_2\text{S}$ . Also, since two NH groups are present, these may be replaced by  $\text{CH}_2$  groups; thus the parent compound is  $\text{C}_{11}\text{H}_{18}\text{OS}$ . The CO group may be replaced by a  $\text{CH}_2$  group and the sulphide atom also by a  $\text{CH}_2$  group. This gives a compound of formula  $\text{C}_{12}\text{H}_{22}$  which has the same "structure" as  $\beta$ -biotin. Now the formula  $\text{C}_{12}\text{H}_{22}$  corresponds to the general formula  $\text{C}_n\text{H}_{2n-2}$ , and this, for a saturated compound, corresponds to a system containing two rings.

When heated with Raney nickel,  $\beta$ -biotin formed *dethiobiotin* by elimination of the sulphur atom (this is an example of the *Mozingo reaction*, 1943).

Dethiobiotin, on hydrolysis with hydrochloric acid, gave a diaminocarboxylic acid which, on oxidation with periodic acid, gave pimelic acid (du Vigneaud *et al.*, 1942). These results can be explained by assuming that the sulphur atom is in a five-membered ring and the *n*-valeric acid side-chain is in the position shown.

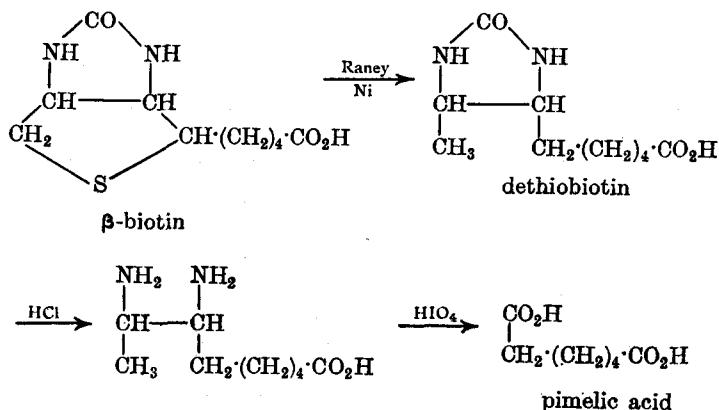

Further evidence for this structure is given by the fact that the exhaustive methylation of the diaminocarboxylic acid (produced from  $\beta$ -biotin), followed by hydrolysis, gave  $\delta$ -(2-thienyl)-valeric acid (du Vigneaud *et al.*, 1942); the structure of this compound was confirmed by synthesis.

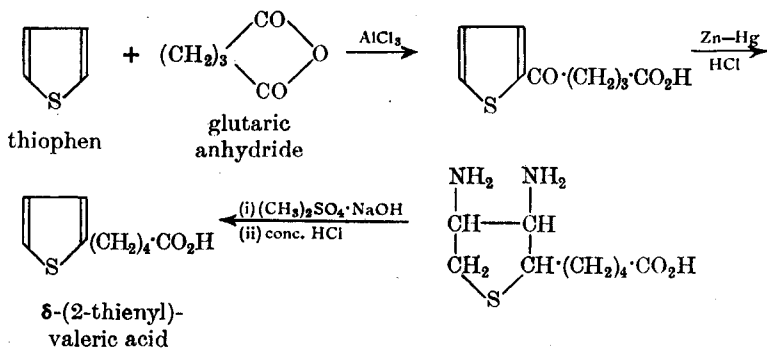

The above structure for  $\beta$ -biotin has been confirmed by synthesis (Harris *et al.*, 1943, 1944).

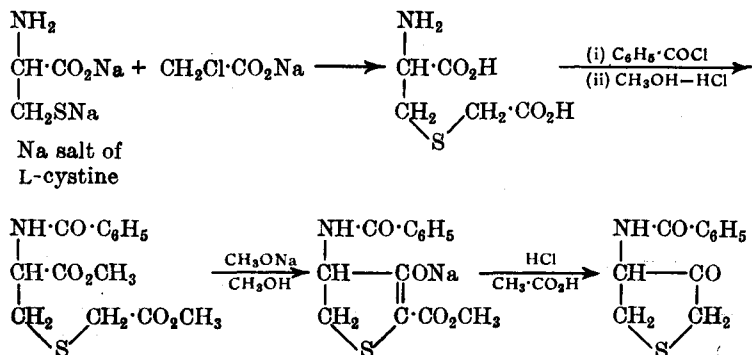



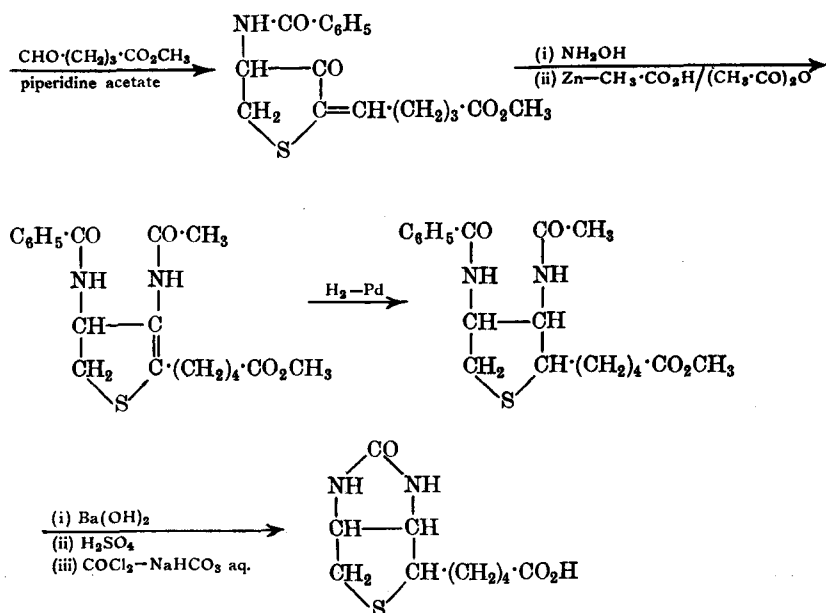

Two racemates were isolated, one of which was ( $\pm$ )- $\beta$ -biotin; this was resolved *via* its esters with ( $-$ )-mandelic acid.

Examination of the  $\beta$ -biotin formula shows the presence of three asymmetric carbon atoms; the rings are fused in the *cis*-position in  $\beta$ -biotin and the orientation of the side-chain is also *cis*, as shown by X-ray analysis (Traub, 1956).

The structure of  $\alpha$ -biotin is uncertain.

**§10. Pyridoxin** (Adermin, vitamin B<sub>6</sub>), C<sub>8</sub>H<sub>11</sub>O<sub>3</sub>N, is obtained from rice bran and yeast; it cures dermatitis in rats. Pyridoxin behaves as a weak base, and the usual tests showed the absence of methoxyl and methylamino-groups. Application of the Zerewitinoff method showed the presence of three active hydrogen atoms. When treated with diazomethane, pyridoxin formed a monomethyl ether which, on acetylation, gave a diacetyl derivative (Kuhn *et al.*, 1938). It therefore appears that the three oxygen atoms in pyridoxin are present as hydroxyl groups, and since one is readily methylated, this one is probably phenolic. This conclusion is supported by the fact that pyridoxin gives the ferric chloride colour reaction of phenols. Thus the other two hydroxyl groups are alcoholic.

Examination of the ultraviolet absorption spectrum of pyridoxin showed that it is similar to that of 3-hydroxypyridine. It was therefore inferred that pyridoxin is a pyridine derivative with the phenolic group in position 3. Since lead tetra-acetate has no action on the monomethyl ether of pyridoxin, this leads to the conclusion that the two alcoholic groups are not on adjacent carbon atoms in a side-chain (Kuhn *et al.*, 1939). When this methyl ether is *very carefully* oxidised with alkaline potassium permanganate, the product is a methoxypyridinetricarboxylic acid, C<sub>9</sub>H<sub>7</sub>O<sub>7</sub>N. This acid gave a blood-red colour with ferrous sulphate, a reaction which is characteristic of pyridine-2-carboxylic acid; thus one of the three carboxyl groups is in the 2-position. When the methyl ether of pyridoxin was oxidised with alkaline permanganate under the usual conditions, the products were carbon dioxide and the anhydride of a dicarboxylic acid, C<sub>8</sub>H<sub>6</sub>O<sub>4</sub>N; thus these two carboxyl groups are in the *ortho*-position. Furthermore, since this anhydride, on

hydrolysis to its corresponding acid, did not give a red colour with ferrous sulphate, there is no carboxyl group in the 2-position. It therefore follows that, on decarboxylation, the tricarboxylic acid eliminates the 2-carboxyl group to form the anhydride; thus the tricarboxylic acid could have either of the following structures.

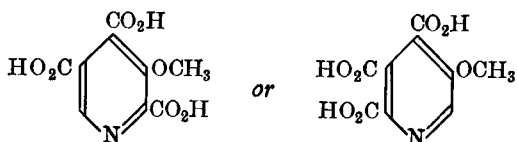

Now pyridoxin methyl ether contains three oxygen atoms (one as methoxy and the other two alcoholic); it is therefore possible that two carboxyl groups in the tricarboxylic acid could arise from two  $\text{CH}_2\text{OH}$  groups, and the third from a methyl group, *i.e.*, pyridoxin could be either of the following:

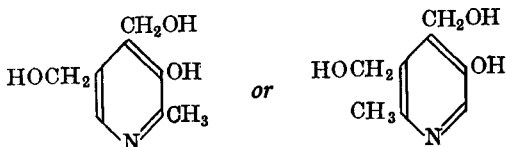

A decision between the two structures was made on the following evidence. When pyridoxin methyl ether was oxidised with barium permanganate, the product was a dicarboxylic acid,  $\text{C}_6\text{H}_5\text{O}_5\text{N}$ , which did not give a red colour with ferrous sulphate; thus there is no carboxyl group in the 2-position. Also, since the dicarboxylic acid formed an anhydride and gave a phthalein on fusion with resorcinol, the two carboxyl groups must be in the *ortho*-position. Furthermore, analysis of both the dicarboxylic acid and its anhydride showed the presence of a methyl group. Thus the structure of this dicarboxylic acid is either I or II.

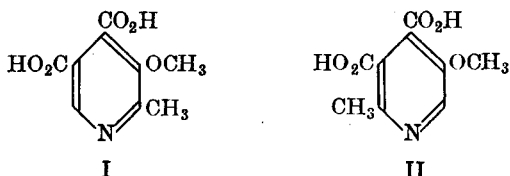

Kuhn *et al.* (1939) showed that the anhydride was that of I from its formation by the oxidation of 4-methoxy-3-methyl-*iso*quinoline (a synthetic compound of known structure).

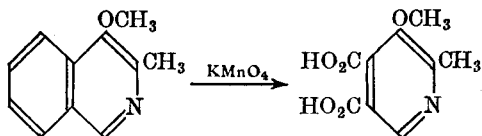

Hence, on the foregoing evidence, pyridoxin is

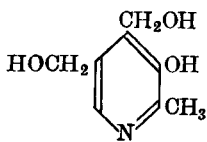

pyridoxin

This structure has been confirmed by synthesis, *e.g.*, that of Harris and Folkers (1939):

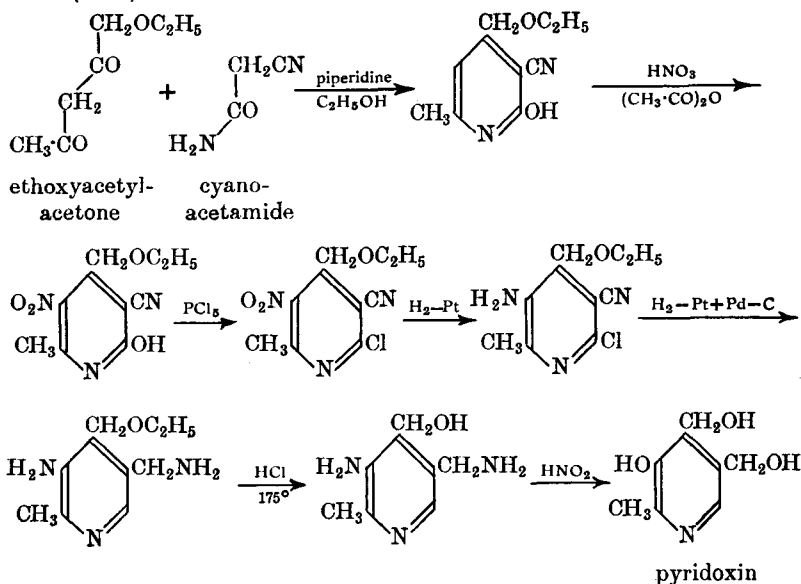

§11. **Nicotinic acid and nicotinamide.** These two compounds have been shown to be the human pellagra-preventing (P.P.) factor. Nicotinamide is part of the co-enzymes codehydrogenase I and II, which play a part in many biological oxidations.

Nicotinic acid (*Niacin*) was first prepared by the oxidation of nicotine (§21. XIV). This is now used as a commercial method; another commercial method for the preparation of nicotinic acid is the vapour-phase oxidation of 3-methylpyridine ( $\beta$ -picoline) in the presence of a vanadium and iron catalyst.

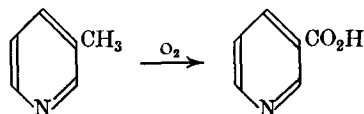

Still another commercial method is the oxidation of quinoline to quinolinic acid, which is then decarboxylated to nicotinic acid (see also §21. XIV).

Nicotinamide, m.p. 131°, is manufactured by various methods, *e.g.*, by the action of ammonia on nicotiny chloride, or by heating nicotinic acid with urea in the presence of a molybdenum catalyst.

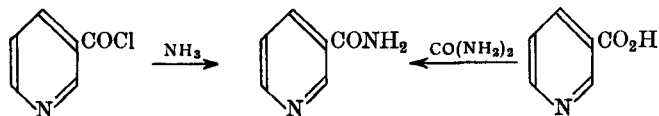

§12. **Vitamin B<sub>12</sub>, Cyanocobalamin.** This is the anti-pernicious anæmia factor, and has been isolated from liver extract. Folic acid (§8) also has anti-anæmic properties. Vitamin B<sub>12</sub> has been obtained as a red crystalline substance (Folkers *et al.*, 1948; Smith *et al.*, 1948, 1949), and the elements present have been shown to be C, H, O, N, P, Co; this vitamin is the first natural product found to contain cobalt. The cobalt has been shown to

be attached to a cyano group. The hydrolysis of vitamin B<sub>12</sub> with hydrochloric acid under different conditions produces ammonia, 1-aminopropan-2-ol (I), 5 : 6-dimethylbenzimidazole (II), 5 : 6-dimethylbenzimidazole-1- $\alpha$ -D-ribofuranoside (III) and the 3'-phosphate of III (Folkers *et al.*, 1949, 1950; Todd *et al.*, 1950). Compound IV (a succinimide derivative) has also been isolated by the chromic acid oxidation of hydrolysed vitamin B<sub>12</sub> (Folkers, 1955).

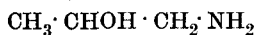

I

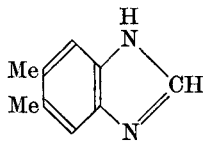

II

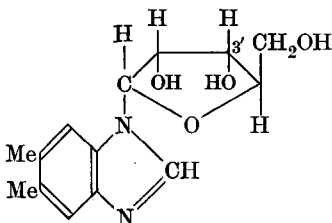

III

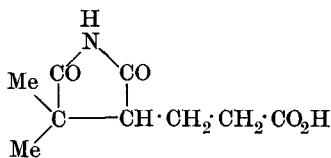

IV

Other work has shown that six amido groups are present in the molecule. Also, alkaline hydrolysis of vitamin B<sub>12</sub> gives a mixture consisting mainly of a penta- and a hexacarboxylic acid, in both of which the nucleotide fragment is absent. As the result of a detailed X-ray analysis of the hexacarboxylic acid, vitamin B<sub>12</sub> has been assigned the structure shown.

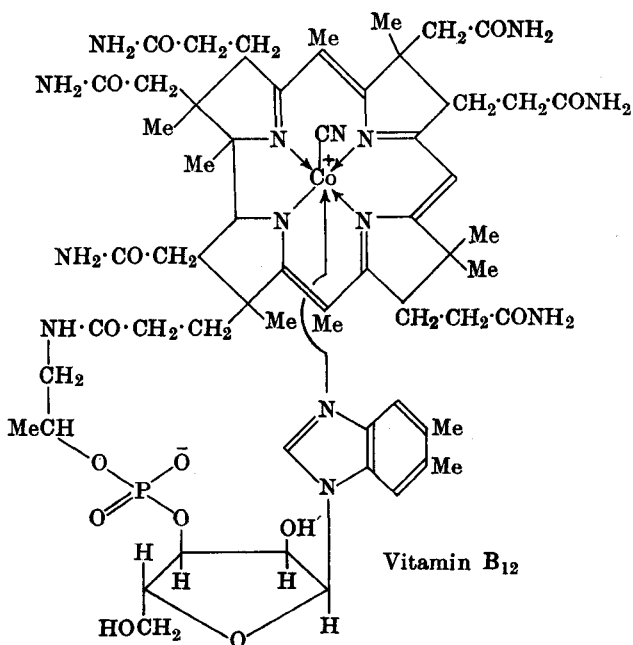

A point of interest is that the arrangement of the four pyrrole nuclei is somewhat similar to that in the natural porphyrin derivatives such as h em and chlorophyll (§§2, 7. XIX).

A number of vitamin B<sub>12</sub> compounds have now been isolated which differ only in the nature of the basic component of the nucleotide. The remainder of the molecule, which is referred to as **Factor B**, is common to all the members of the vitamin B<sub>12</sub> group. A partial synthesis of vitamin B<sub>12</sub> (starting from factor B) has now been carried out by Bernhauer *et al.* (1960).

§13. **Other compounds of the vitamin B complex.** Three other compounds which have definitely been isolated from the vitamin B complex are:

- (i) *p*-Aminobenzoic acid; this is a growth factor for bacteria.
- (ii) *meso*Inositol (m.p. 225–226°). This is a growth factor in animals, and its configuration has been elucidated by Posternak (1942; see also §11 iv. IV).
- (iii) Choline. The absence of this compound leads to the formation of a fatty liver in animals.

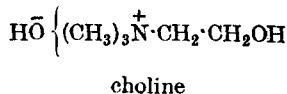
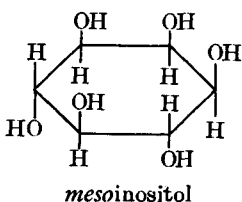
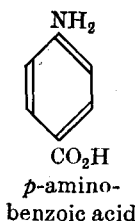

Other vitamins of the vitamin B complex that have been said to exist are vitamins B<sub>3</sub>, B<sub>4</sub>, B<sub>5</sub>, B<sub>10</sub>, B<sub>11</sub>, B<sub>13</sub>, B<sub>14</sub> and others.

### VITAMIN E GROUP

§14. **Introduction.** Vitamin E is the anti-sterility factor; it occurs in seed germ oils. It is now known that there are three closely related compounds comprising "vitamin E"; all three are biologically active, and are known as  $\alpha$ -,  $\beta$ - and  $\gamma$ -tocopherol. The main source of  $\alpha$ - and  $\beta$ -tocopherol is wheat germ oil; the  $\gamma$ -compound is obtained from cotton seed oil. Wheat germ oil was first subjected to chromatographic analysis to remove sterols, etc., and then the  $\alpha$ - and  $\beta$ -tocopherols were purified by conversion into their crystalline allophanates (see §12. XII) or 3 : 5-dinitrobenzoates. Hydrolysis of these derivatives gave the tocopherols as pale yellow oils.

§15.  **$\alpha$ -Tocopherol**, C<sub>29</sub>H<sub>50</sub>O<sub>2</sub>. When  $\alpha$ -tocopherol is heated at 350°, duroquinol is obtained (Fernholz, 1937). On the other hand, when heated with selenium,  $\alpha$ -tocopherol forms duroquinone (McArthur *et al.*, 1937). Finally, when heated with hydriodic acid, *p*-cumenol is formed (John *et al.*, 1937).

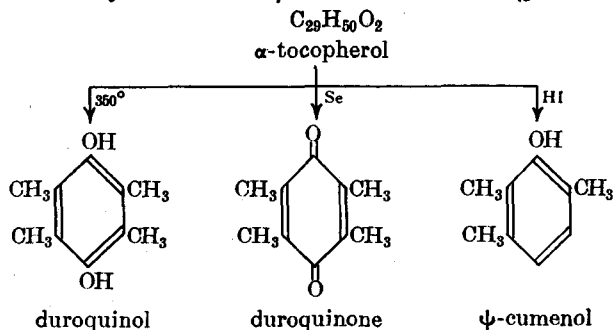

The formation of these products led to the suggestion that  $\alpha$ -tocopherol was the monoether of duroquinol; the possibility that it might be the diether was ruled out by the fact that  $\alpha$ -tocopherol forms an allophanate, which indicates the presence of one free hydroxyl group. This monoether structure was shown to be incorrect by the fact that the ultraviolet absorption spectra of various monoethers of duroquinol were different from that of  $\alpha$ -tocopherol (Fernholz, 1938).

Oxidation of  $\alpha$ -tocopherol with chromic acid forms dimethylmaleic anhydride and a compound  $C_{21}H_{40}O_2$ .

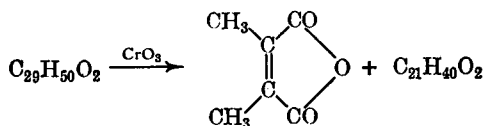

This latter compound was shown to be an optically active saturated lactone. This lactone was then shown to be derived from a  $\gamma$ -hydroxyacid in which the hydroxyl group is tertiary, *e.g.*, the acid lactonised immediately its salt was acidified, and also could not be oxidised to a keto-acid. Thus the structure of this lactone may be written ( $R + R' = 17C$ ):

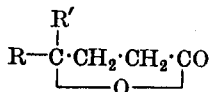

Now  $\alpha$ -tocopherol acetate, on oxidation with chromic acid, forms an acid,  $C_{16}H_{33}O_2$ , I, and a ketone,  $C_{16}H_{33}O$ , II. Both of these compounds must be produced by the oxidation of the lactone at different points in the chain. Fernholz therefore suggested that if in the lactone  $R = C_{16}H_{33}$  and  $R' = CH_3$ , then the products I and II can be accounted for; thus:

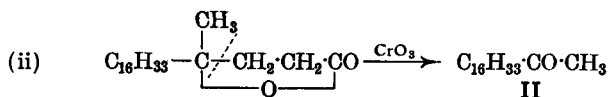
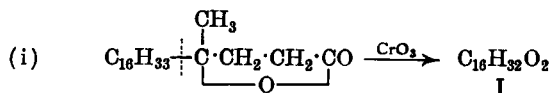

Fernholz then showed that the acid (I) contained methyl groups (*cf.* §3. IX), and was led to propose a structure based on the isoprene unit, *viz.*

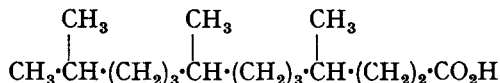

The evidence obtained so far indicates the presence of a substituted benzene ring and a long side-chain in  $\alpha$ -tocopherol. When the monoethers of duroquinol (see above) were oxidised with silver nitrate solution, the action took place far more slowly than for  $\alpha$ -tocopherol when oxidised under the same conditions. Furthermore, whereas the former compounds were oxidised to duroquinone, the latter compound gave a red oil which appeared to have approximately the same molecular weight as  $\alpha$ -tocopherol (Fernholz, 1938). Since duroquinone is not split off during this oxidation, it suggests that the side-chain is connected to the aromatic ring by a carbon bond as well as an ether link. In this case  $\alpha$ -tocopherol is either a chroman or coumaran derivative:

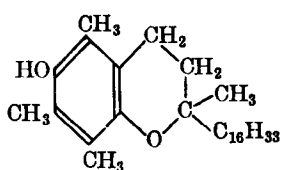

chroman structure

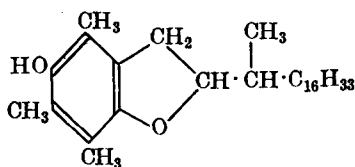

coumaran structure

According to Fernholz, the oxidation products are best explained on the chroman structure. This has been supported by ultraviolet absorption measurements of  $\alpha$ -tocopherol (John *et al.*, 1938).

Karrer *et al.* (1938) have synthesised ( $\pm$ )- $\alpha$ -tocopherol by condensing trimethylquinol with phytyl bromide (§30. VIII).

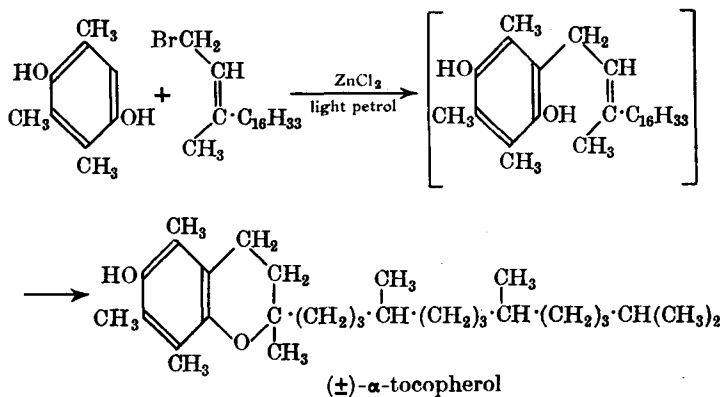

This synthesis, however, is not completely unambiguous, since phenols may condense with allyl compounds to form coumarans. Smith *et al.* (1939) have shown that  $\gamma$ : $\gamma$ -disubstituted halides form only chromans, and since phytyl bromide is a halide of this type, this strengthens the course of the synthesis given above. Finally, Smith *et al.* (1942) have carried out an unambiguous synthesis of  $\alpha$ -tocopherol as follows:

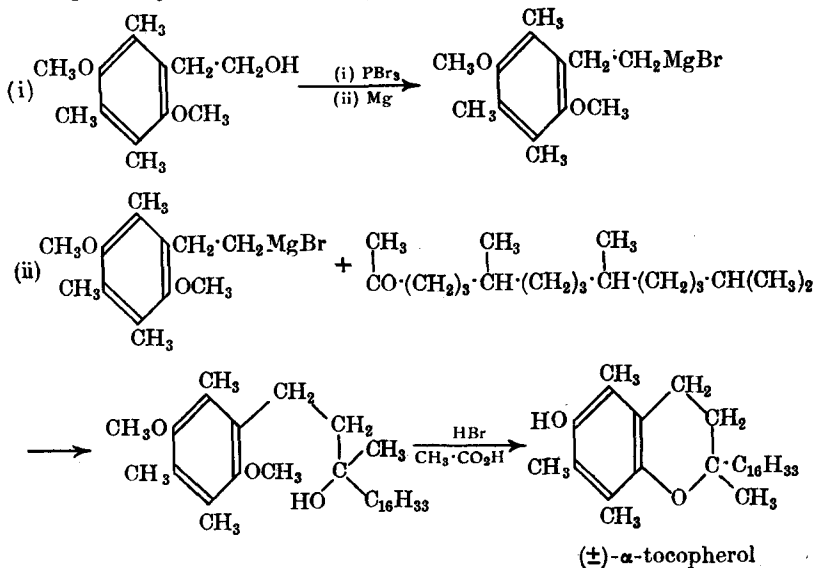

Smith *et al.* prepared the methyl ketone by ozonolysis of phytol, and also by oxidation of phytol with chromic acid.

§16.  **$\beta$ -Tocopherol**,  $C_{28}H_{48}O_2$ . This formula differs from that of  $\alpha$ -tocopherol by  $CH_2$ . Thermal decomposition of  $\beta$ -tocopherol gives trimethylquinol, I, and heating with hydriodic acid *p*-xylenol, II (John *et al.*, 1937).

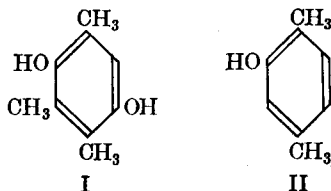

When oxidised with chromic acid,  $\beta$ -tocopherol gives the same lactone ( $C_{21}H_{40}O_2$ ) as that obtained from  $\alpha$ -tocopherol. Thus the only difference between the two tocopherols is that the  $\alpha$ -compound has one more methyl group in the benzene ring than the  $\beta$ -; hence the latter is

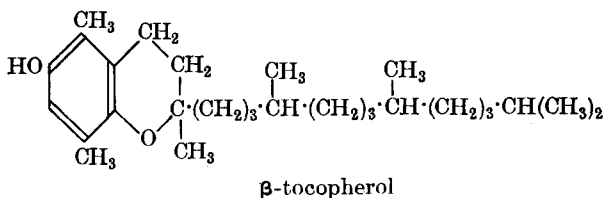

This has been confirmed by synthesis, starting from the monoacetate of *p*-xyloquinol and phytyl bromide.

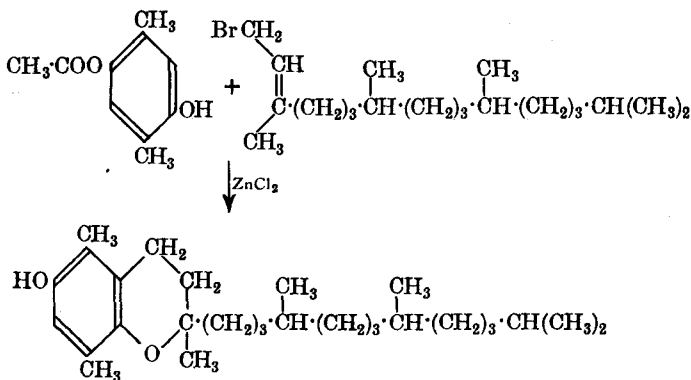

§17.  **$\gamma$ -Tocopherol**,  $C_{28}H_{48}O_2$ . This is isomeric with  $\beta$ -tocopherol; the only difference is the positions of the two methyl groups in the benzene ring, *e.g.*, when heated with hydriodic acid,  $\gamma$ -tocopherol gives *o*-xyloquinol. Thus  $\gamma$ -tocopherol is

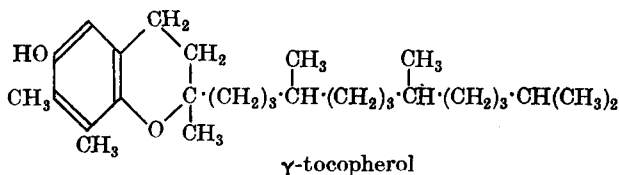



This structure has been confirmed by synthesis, starting from the monoacetate of *o*-xyloquinol and phytyl bromide.

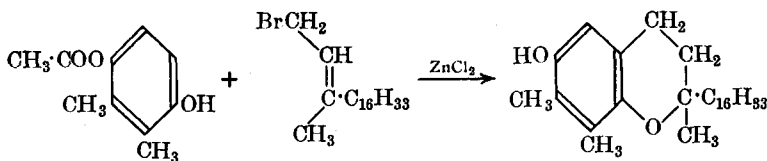

§18.  **$\delta$ -Tocopherol**,  $C_{27}H_{46}O_2$ . This was isolated from soya bean oil by Stern *et al.* (1947); it is a yellow oil, and is inactive physiologically. The structure of  $\delta$ -tocopherol is

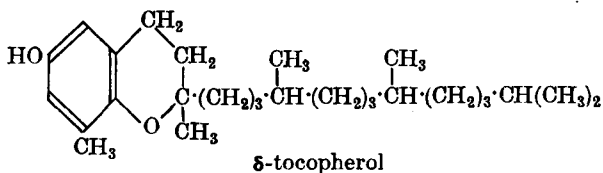

### VITAMIN K GROUP

§19. **Introduction.** Dam *et al.* (1939) and Doisy *et al.* (1939) isolated vitamin K from alfalfa, and called it vitamin  $K_1$  to distinguish it from a substance called vitamin  $K_2$  which had been isolated from putrefied fish meal by Doisy *et al.* (1939). Both are antihæmorrhagic vitamins; they are connected with the enzymes involved in blood clotting, a deficiency of them lengthening the time of blood clotting. Kegel *et al.* (1962) have obtained chemical evidence for the presence of vitamin  $K_1$  in extracts from spinach chloroplasts.

§20. **Vitamin  $K_1$**  ( $\alpha$ -phyloquinone),  $C_{31}H_{46}O_2$ , is a light yellow oil. The redox potential of vitamin  $K_1$  is very similar to that of 1 : 4-quinones (Karrer *et al.*, 1939), and its absorption spectrum is very similar to that of 2 : 3-disubstituted 1 : 4-naphthaquinones (McKee *et al.*, 1939). Thus vitamin  $K_1$  appears to be a 1 : 4-naphthaquinone derivative, and this is in keeping with the fact that the vitamin is very sensitive to light and to alkalis. Now the catalytic hydrogenation of vitamin  $K_1$  causes the addition of four molecules of hydrogen (McKee *et al.*, 1939); the product is a colourless compound. Since it is known that three molecules of hydrogen are added when 1 : 4-naphthaquinone is reduced under these conditions, the addition of a fourth molecule of hydrogen to the vitamin suggests the presence of an ethylenic double bond in a side-chain.

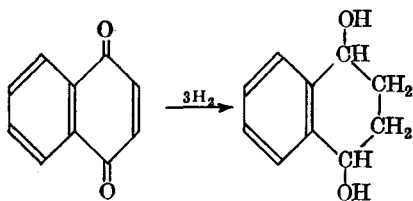

When subjected to reductive acetylation (*i.e.*, acetylated under reducing conditions), vitamin  $K_1$  is converted into the diacetate of dihydrovitamin  $K_1$  (Binkley *et al.*, 1939). This diacetate is difficult to hydrolyse; this is a property characteristic of 2 : 3-disubstituted 1 : 4-naphthaquinones. When oxidised with chromic acid, vitamin  $K_1$  gives phthalic acid, but when the oxidation is carried out under controlled conditions, the product is a compound with the molecular formula  $C_{13}H_{10}O_4$ . This latter compound was subsequently shown to be 2-methyl-1 : 4-naphthaquinone-3-acetic acid (Binkley *et al.*, 1939).

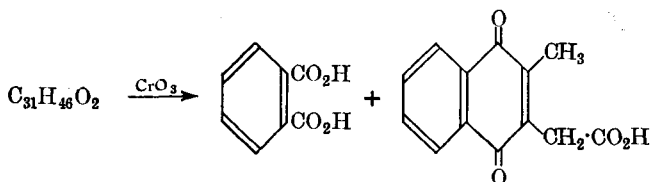

Thus the presence of the 1 : 4-naphthaquinone structure is confirmed, and at the same time these products show that one ring is unsubstituted and that the other (the quinonoid ring) has substituents in the 2- and 3-positions.

When the diacetate of dihydrovitamin  $K_1$  (see above) was subjected to ozonolysis, a compound  $C_{18}H_{36}O$  was obtained, which was then shown to be identical with the ketone produced by the oxidation of phytol (McKee *et al.*, 1939; *cf.* Smith's synthesis of  $\alpha$ -tocopherol, §15). Hence, on the evidence obtained above, vitamin  $K_1$  is 2-methyl-3-phytyl-1 : 4-naphthaquinone.

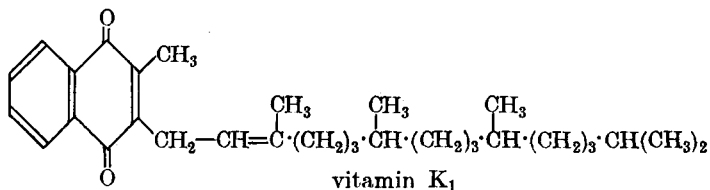

This structure has been confirmed by synthesis: Almquist *et al.* (1939) obtained vitamin  $K_1$  by condensing 2-methyl-1 : 4-naphthaquinone with phytol; Fieser *et al.* (1939) obtained a better yield by heating 2-methyl-1 : 4-naphthaquinol with phytol in dioxan solution in the presence of anhydrous oxalic acid, and then oxidising the product, dihydrovitamin  $K_1$ , with silver oxide in ether.

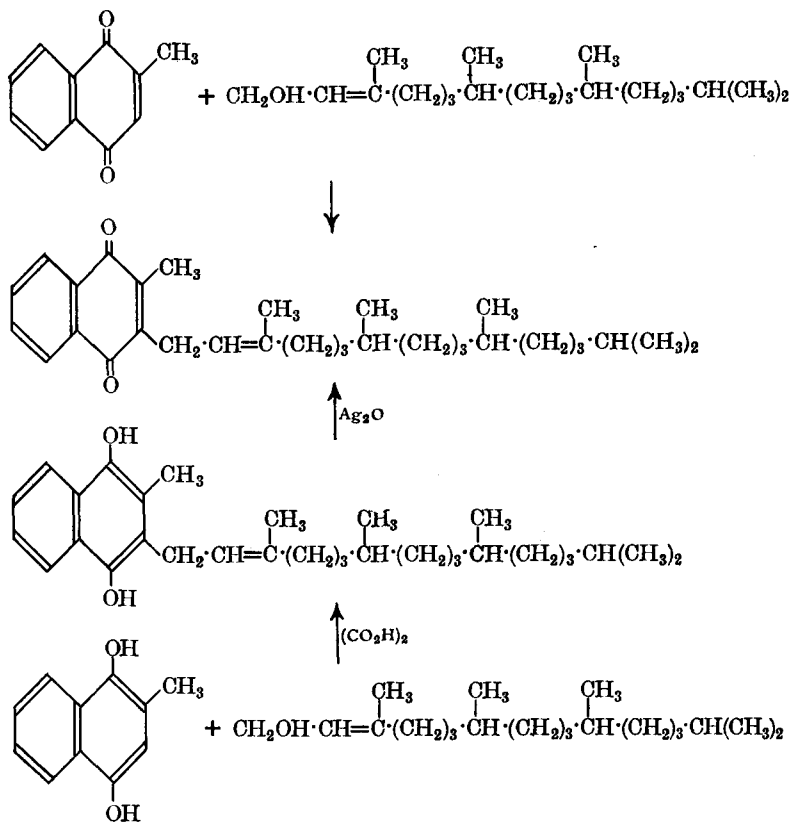

Wendler *et al.* (1954) have obtained vitamin  $K_1$  in good yield by condensing the 1-acetyl derivative of 2-methyl-1 : 4-naphthaquinol with phytol in the presence of boron trifluoride.

§21. **Vitamin  $K_2$** ,  $C_{41}H_{56}O_2$ , is a yellow solid, m.p.  $54^\circ$ ; it is less potent than vitamin  $K_1$ . It was shown to contain a 1 : 4-naphthaquinone nucleus by the facts that it is sensitive to light and to alkalis, and that it has an absorption spectrum similar to that of vitamin  $K_1$  (McKee *et al.*, 1939). When catalytically reduced, vitamin  $K_2$  adds on nine molecules of hydrogen, and since three of these are absorbed by the naphthaquinone nucleus (see §20), it therefore suggests that there is a side-chain present which contains six double bonds. Furthermore, since vitamin  $K_2$  does not form an adduct with maleic anhydride, no conjugation is present (McKee *et al.*, 1939). That these six double bonds are ethylenic is shown by the fact that on reductive acetylation, vitamin  $K_2$  forms the diacetate of dihydrovitamin  $K_2$ , which can add on six molecules of bromine.

The oxidation of vitamin  $K_2$  with permanganate produces phthalic acid; therefore one ring is unsubstituted. On the other hand, when ozone is passed into a solution of vitamin  $K_2$  in acetic acid, and the product then treated with zinc dust in ether, 1 : 4-diacetoxy-2-methylnaphthalene-3-acetaldehyde is produced. At the same time there is obtained lævulaldehyde in a yield of 93 per cent. calculated on the basis that one molecule of vitamin  $K_2$  can produce five molecules of the aldehyde.

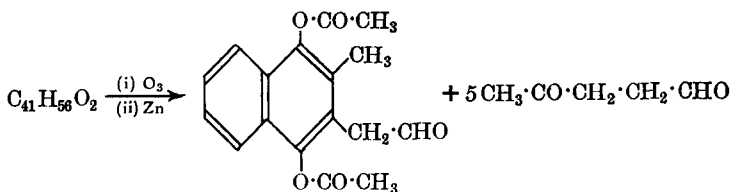

Acetone is also formed in this reaction, and is obtained in a yield of 56 per cent. based on the assumption that one molecule of acetone is produced from one molecule of vitamin  $\text{K}_2$  (McKee *et al.*, 1940). On this evidence, it has been suggested that vitamin  $\text{K}_2$  is 3-difarnesyl-2-methyl-1:4-naphthaquinone (Binkley *et al.*, 1940).

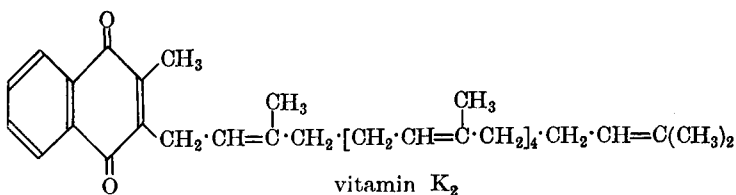

**§22. Other compounds possessing antihæmorrhagic properties.** It has been shown that simple 1:4-naphthaquinones have blood-clotting properties. 2-Methyl-1:4-naphthaquinone is more active than either vitamin  $\text{K}_1$  or  $\text{K}_2$  (Fernholz *et al.*, 1939); it is therefore used instead of the natural vitamins. *Phthiocol* (3-hydroxy-2-methyl-1:4-naphthaquinone) is also an active compound, and is water-soluble. It is also interesting to note that many quinones other than 1:4-naphthaquinones have also been found to be active, *e.g.*, some *p*-benzoquinones.

#### READING REFERENCES

- Vitamins, A Survey of Recent Knowledge*, Medical Research Council Report (1932).  
 Rosenberg, *Chemistry and Physiology of the Vitamins*, Interscience Publishers (1942).  
*Vitamins and Hormones*, Academic Press (1943- ).  
 Stewart and Graham, *Recent Advances in Organic Chemistry*, Longmans, Green. Vol. III (1948, 7th ed.). Ch. 2. Vitamins.  
 Robinson, *The Vitamin B Complex*, Chapman and Hall (1951).  
 Harris, *Vitamins in Theory and Practice*, Cambridge University Press (1955, 4th ed.).  
 Rodd (Ed.), *Chemistry of Carbon Compounds*, Elsevier. Vol. IVC (1960). Ch. XXII. Pteridines, Alloxazines, Flavins.  
 Structure of Vitamin  $\text{B}_{12}$ .  
 (i) Dorothy Crowfoot Hodgkin *et al.*, *Nature*, 1955, **176**, 325; 1956, **178**, 64.  
 (ii) Todd *et al.*, *Nature*, 1955, **176**, 330.  
 (iii) *Chem. Soc. Special Publ.*, No. 3, 1955.

CHAPTER XVIII  
CHEMOTHERAPY

§1. **Introduction.** The term *chemotherapy* was introduced by Ehrlich (1909), and it now appears to be used in the sense of the treatment of diseases due to bacterial invasion by chemical compounds which destroy the micro-organisms without affecting, to any material extent, the tissues (of the host). Many compounds, *e.g.*, formaldehyde, phenol, iodine, etc., are also active in destroying bacteria. These compounds, however, are applied *externally*, and tend to destroy the tissues; thus they are not included under the heading of therapeutic agents, but are known as *disinfectants*.

The first compounds to be used by Ehrlich (1907) were organic dyes. From then onwards, organic compounds of diverse chemical structures have been used in chemotherapy. It has now been found that a given compound is specific in its toxicity towards a particular micro-organism. The relationship between chemical structure and chemotherapeutic action is extremely complicated, but some progress has been made in this field.

Compounds which exert various physiological effects of therapeutic value are collectively known as *drugs*. The ideal requirement of a drug is that, on administration (to the host), it should be localised at the site where it is required. In practice, however, no drug behaves in this way, but tends to distribute itself anywhere in the tissues of the host. Another difficulty is that cells, which were originally susceptible to a particular drug, may acquire a tolerance (resistance) to that drug. In some cases it has been found that the drug actually reverses its original action, *i.e.*, it stimulates the cell instead of inhibiting it.

There have been three approaches to the problem of finding a drug to combat a particular disease:

(i) The method of trial and error. This involves the trial of all kinds of compounds, natural and synthetic.

(ii) The method requiring a knowledge of the cell system, and then synthesising compounds which interfere with it.

(iii) The method in which one starts with a compound known to have some of the required activity (this information has been gained from the previous methods), and then to vary the structure of the molecule systematically. This method has, so far, proved to be the most fruitful.

§2. **Sulphonamides.** **Sulphanilamide** (*p*-aminobenzenesulphonamide) and its derivatives have great antibacterial powers; sulphanilamide itself is widely used in medicine against "cocci infections"—streptococci, gonococci and pneumococci. Research in the sulphonamide field was stimulated by the discovery of Domagk (1934) that prontosil (see below) had a curative effect when injected into mice infected with streptococci.

The system of numbering is as follows: substituents of the amide group of sulphanilamide are called  $N^1$ -substituents, and substituents of the amino group are called  $N^4$ -substituents.

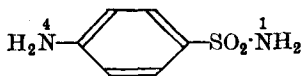

sulphanilamide

Sulphanilamide may be prepared from acetanilide:

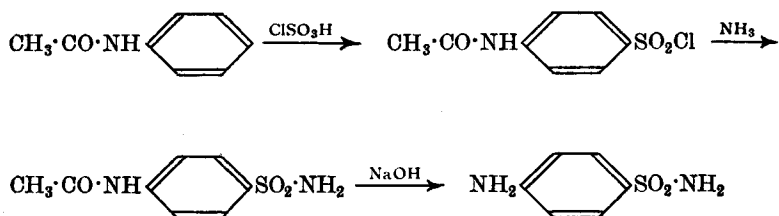

**Sulphapyridine** (*N*<sup>1</sup>-2-pyridylsulphanilamide) was the first drug to effect cures of pneumonia; it is more potent than sulphanilamide. It may be prepared as follows:

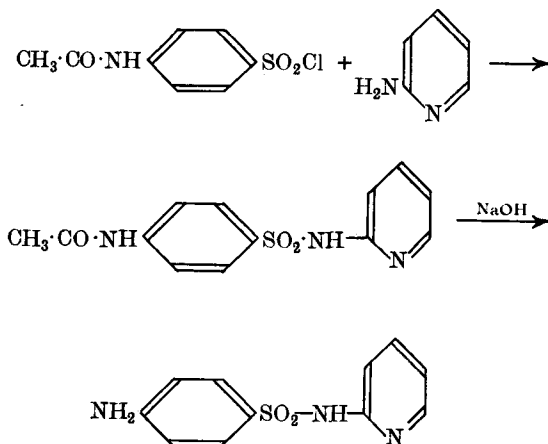

This compound was introduced under the trade name of *M and B 693*.

**Sulphathiazole** (*N*<sup>1</sup>-2-thiazolylsulphanilamide) is more potent than *Sulphapyridine* and less toxic; it is used mainly in severe infections. It is

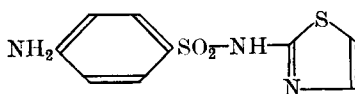

prepared in the same way as *Sulphapyridine* except that 2-aminothiazole is used instead of 2-aminopyridine.

**Sulphadiazine** (*N*<sup>1</sup>-2-pyrimidylsulphanilamide; *Sulphapyrimidine*) is less toxic than *Sulphathiazole*; it is the most widely used of the "sulpha" drugs, its main use being for mild infections. It is prepared in the same way as the previous compound, except that 2-aminopyrimidine is used in this case.

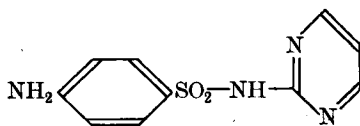

**Sulphamezathine** (*N*<sup>1</sup>-2(4:6-dimethylpyrimidyl)-sulphanilamide) is also used for general purposes.

**Sulphaguanidine**, since it is only slightly absorbed in the intestinal tract, can therefore be given in relatively large doses in the treatment of bacillary dysentery.

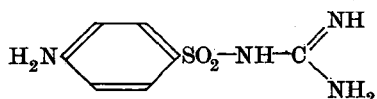

**Prontosil** (4-sulphonamido-2':4'-diaminoazobenzene) was the first sulphonamide to be used in medicine. It is prepared by diazotising sulphanilamide and then coupling with *m*-phenylenediamine.

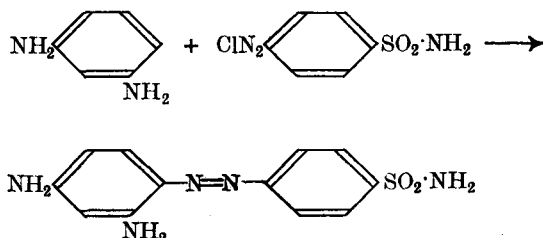

It was suggested that *Prontosil* broke down in the body to sulphanilamide; this led to the discovery that the latter compound is very active against bacteria.

**Prontosil S** is more soluble than *Prontosil*.

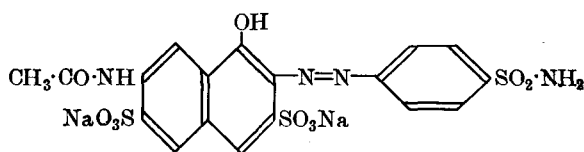

**Mechanism of action of the sulphonamides.** It appears that the antibacterial activity of the sulphonamides is associated with the group

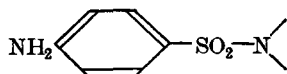

Some compounds containing slight variations from this structure are also active, e.g.,

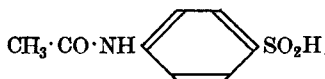

Compounds in which the amino-group is *ortho* or *meta* to the sulphonamido-group are either less active or completely inactive.

*p*-Aminobenzoic acid is an essential growth factor for most bacteria susceptible to the sulphonamides. The theory of action is that, owing to the similarity in structure, bacteria absorb a sulphonamide "by mistake", and once this compound is ingested, the bacteria cease to grow in numbers (Woods, 1940). Thus the sulphonamides are not bactericidal but bacteriostatic.

**§3. Antimalarials.** Quinine (§25b. XIV) was originally the only drug known to be effective against malaria. Now there is a number of synthetic compounds used for this purpose, e.g., *Plasmoquin*, *Mepacrine*, *Proguanil*.

*Plasmoquin* (*Pamaquin*) is 8-(4'-diethylamino-1'-methylbutylamino)-6-methoxyquinoline. One preparation that has been described for this compound is the condensation between 4-bromo-1-diethylaminopentane and 8-amino-6-methoxyquinoline, the latter being prepared from 4-amino-3-nitroanisole by means of the Skraup synthesis (see Vol. I).

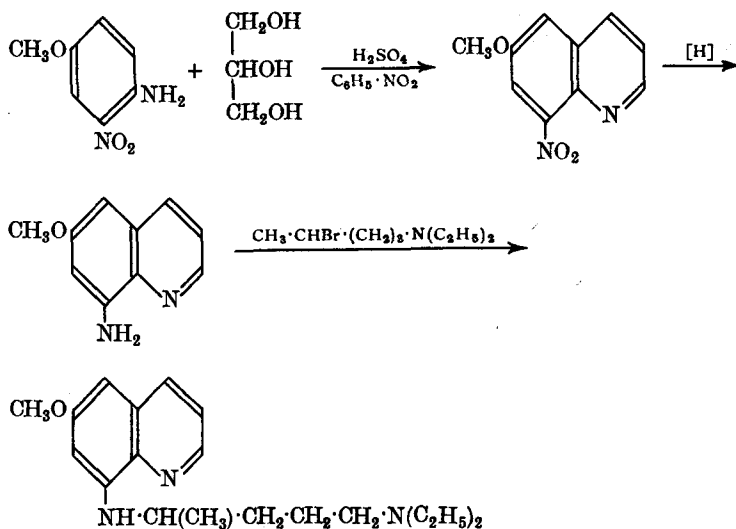

*Mepacrine* (*Atebrin*, *Quinacrine*) is 2-chloro-5-(4'-diethylamino-1'-methylbutylamino)-7-methoxyacridine. It is better than quinine, and it has been prepared as follows:

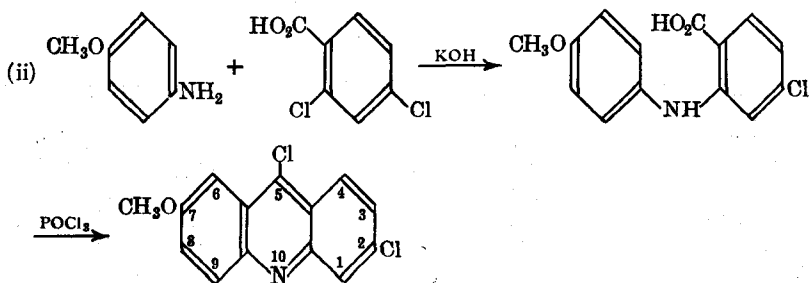
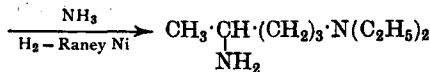
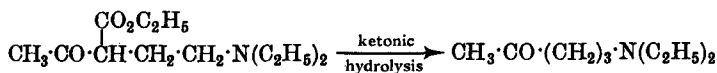
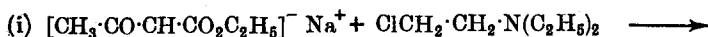



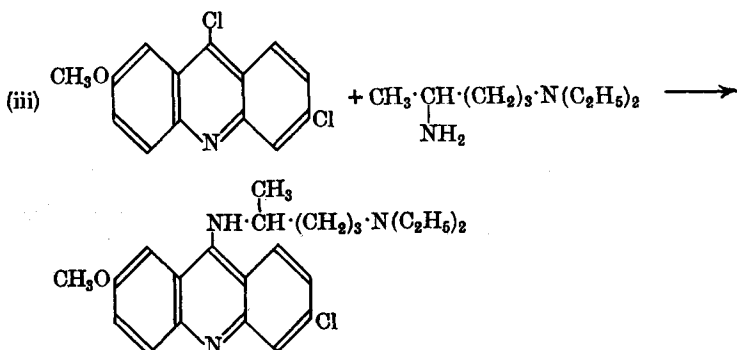

*Mepacrine* has certain unpleasant side-effects (such as producing a yellow colour in the skin, nausea, etc.), and a drug superior to both quinine and *Mepacrine* is *Chloroquine* (*Aralen*).

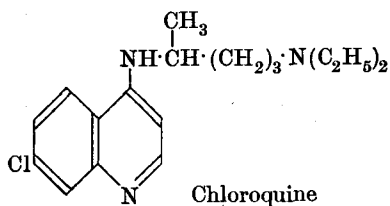

**Proguanil** (*Paludrine*) is *N*<sup>1</sup>-*p*-chlorophenyl-*N*<sup>5</sup>-isopropyldiguanide. It is superior to *Mepacrine* and *Chloroquine*, and appears to be the best antimalarial known at the present time.

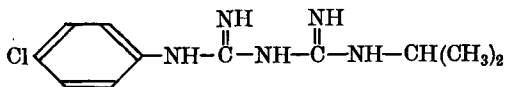

§4. **Arsenical drugs.** A particularly important use of arsenical drugs is in the treatment of syphilis.

**Arsphenamine** (*Salvarsan*, "606") was first introduced by Ehrlich (1909); it is 3 : 3'-diamino-4 : 4'-dihydroxyarsenobenzene, and may be prepared as follows:

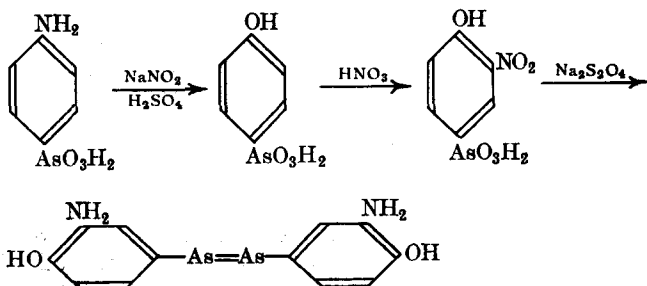

Arsphenamine is an unstable compound; it is stable as its dihydrochloride which, however, cannot be used as such but must be converted into the soluble sodium salt. Ehrlich (1912) overcame this difficulty by preparing **neorsphenamine** (*Neosalvarsan*), a soluble compound, which may be produced by condensing arspenamine with sodium formaldehydesulphoxylate,  $\text{CH}_2\text{OH}\cdot\text{SO}_2\text{Na}$ .

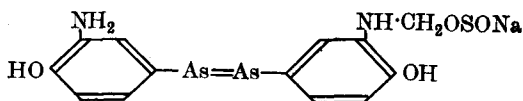

neoarsphenamine

*Atoxyl* is the sodium salt of *p*-arsanilic acid (*p*-aminophenylarsonic acid); it is used in the treatment of sleeping sickness. *p*-Arsanilic acid may be prepared by heating aniline with arsenic acid at 200° (*cf.* sulphanilic acid, Vol. I).

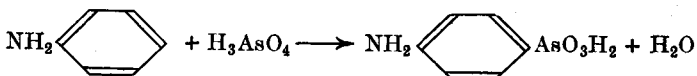

*Tryparsamide* is the sodium salt of *N*-phenylglycineamide-*p*-arsonic acid; it is less toxic than *Atoxyl*, and may be prepared by refluxing the latter with chloroacetamide.

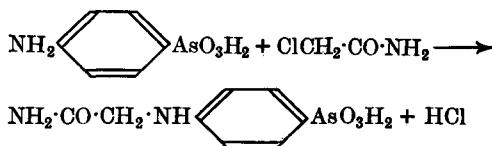

§5. **Antibiotics.** Many micro-organisms produce within themselves chemical substances which, when excreted, interfere with the growth or metabolism of other micro-organisms. Such compounds are known as *antibiotics*, and need be present only in low concentration to bring about this antibiotic action. Antibiotics are thus chemotherapeutic agents.

In 1929, Fleming discovered a mould of the *Penicillium* species which inhibited the growth of certain bacteria. This observation was investigated later by a number of workers and culminated in the isolation of the active principle *penicillin*. At the same time, research along this line led to the isolation of many other antibiotics.

§6. **The penicillins.** Penicillin is the name given to the mixture of natural compounds having the molecular formula  $C_9H_{11}O_4N_2SR$ , and differing only in the nature of R. There are at least five natural penicillins.

Chemical Name	Other Names	R
Pent-2-enylpenicillin . . .	Penicillin-I or F	$-\text{CH}_2\cdot\text{CH}=\text{CH}\cdot\text{CH}_2\cdot\text{CH}_3$
Benzylpenicillin . . . . .	Penicillin-II or G	$-\text{CH}_2\cdot\text{C}_6\text{H}_5$
<i>p</i> -Hydroxybenzylpenicillin . . .	Penicillin-III or X	$-\text{CH}_2\cdot\text{C}_6\text{H}_4\cdot\text{OH}(1:4)$
<i>n</i> -Heptylpenicillin . . . . .	Penicillin-K	$-(\text{CH}_2)_6\cdot\text{CH}_3$
<i>n</i> -Amylpenicillin . . . . .	Dihydro-F-penicillin	$-(\text{CH}_2)_4\cdot\text{CH}_3$

Commercial preparations of penicillin contain one or more of the penicillins in varying proportions. It has been found that the addition to the culture medium of various compounds containing a benzyl group, *e.g.*, phenylacetic acid, phenylacetamide, etc., increases the total yield of penicillin, and also the proportion of benzylpenicillin. Similarly, the addition of compounds containing the *p*-hydroxybenzyl group to the culture medium increases the proportion of *p*-hydroxybenzylpenicillin. On the other hand, by adding various compounds to the culture medium, a number of "unnatural" penicillins have been prepared (see §6b).

§6a. **Structure of the penicillins.** The penicillins are all strong mono-basic acids, *e.g.*, they form salts. The penicillins are hydrolysed by hot dilute inorganic acids; one carbon atom is eliminated as carbon dioxide, and two products are obtained in equimolecular amounts, one being an amine, *penicillamine*, and the other an aldehyde, *penilloaldehyde*. All the penicillins give the same amine, but different aldehydes; it is the latter which contain the R group.

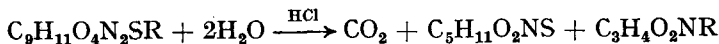

**D-Penicillamine**,  $C_5H_{11}O_2NS$ . Since penicillamine gives the indigo colour reaction with ferric chloride, a test characteristic of cysteine, this suggests that the amine is probably a substituted cysteine. The structure of penicillamine was proved to be D- $\beta$ : $\beta$ -dimethylcysteine by synthesis, *e.g.*,

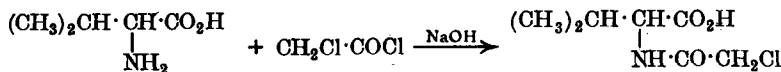

DL-valine

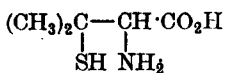
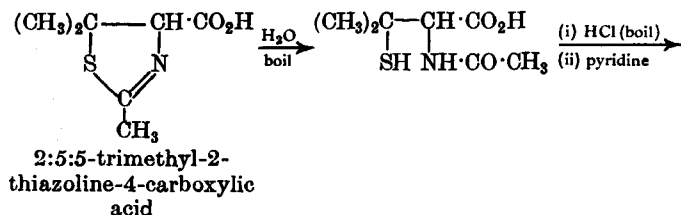
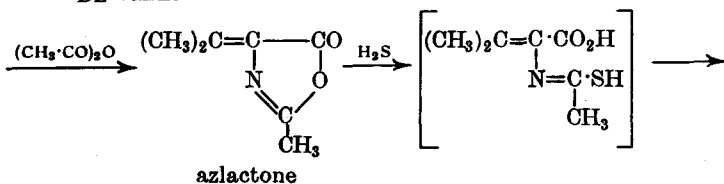

DL-penicillamine

The racemic amine was resolved as follows: the amine was converted into the formyl derivative, which was then resolved by means of brucine. D-Penicillamine was obtained after removal of the formyl group by hydrolysis.

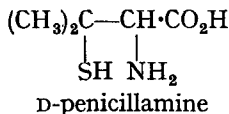
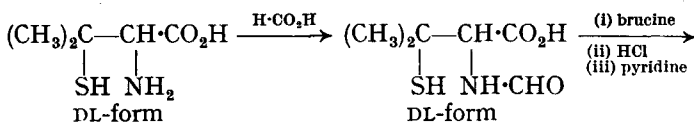

This was found to be identical with the natural penicillamine.

When treated with diazomethane, penicillin is converted into its methyl ester and this, on treatment with an aqueous solution of mercuric chloride, gives the methyl ester of penicillamine. Thus the carboxyl group in penicillamine is the carboxyl group in penicillin itself.

**Penilloaldehyde.** On vigorous hydrolysis, all the penilloaldehydes give a substituted acetic acid and aminoacetaldehyde. Thus the penilloaldehydes are acylated derivatives of aminoacetaldehyde.

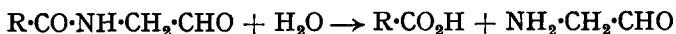

This structure has been confirmed by synthesis:

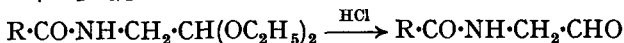

As pointed out above, the acid hydrolysis of penicillin gives penicillamine, penilloaldehyde and carbon dioxide. The formation of this molecule of carbon dioxide gave rise to the belief that it is formed by the ready decarboxylation of an unstable acid. Such an acid is a  $\beta$ -keto-acid, and so a possible explanation is that penilloaldehyde-carboxylic acid (penaldic acid) is formed as an intermediate in the hydrolysis of penicillin (see also below):

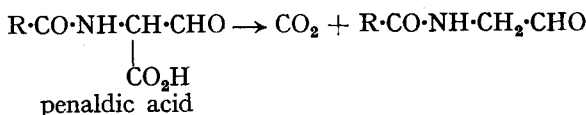

The problem now is: How are the two fragments, penicillamine and penilloaldehyde, combined in penicillin? The hydrolysis of penicillin with dilute alkali or with the enzyme penicillinase produces *penicilloic acid* (a dicarboxylic acid), which readily eliminates a molecule of carbon dioxide to form *penilloic acid*. This suggests that a carboxyl group is in the  $\beta$ -position with respect to a negative group (*cf.* above). Penilloic acid, on hydrolysis with aqueous mercuric chloride, gives penicillamine and penilloaldehyde. This hydrolysis is characteristic of compounds containing a thiazolidine ring (*cf.* §5b. XII). Thus penilloic acid could be I, since this structure would give the required products.

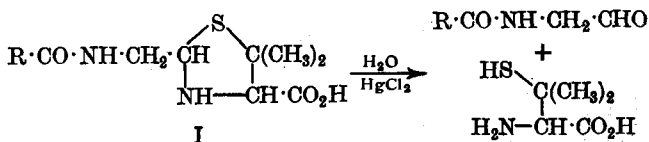

Hence, if I is penilloic acid, then penicilloic acid would be II.

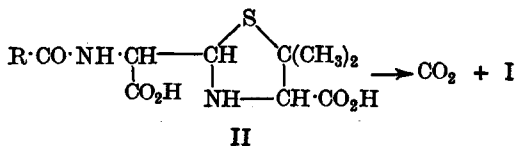

This structure (II) is supported by the fact that the treatment of penicillin with methanol gives methyl penicilloate which, on hydrolysis with aqueous mercuric chloride, gives methyl penaldate (see also above) and penicillamine.

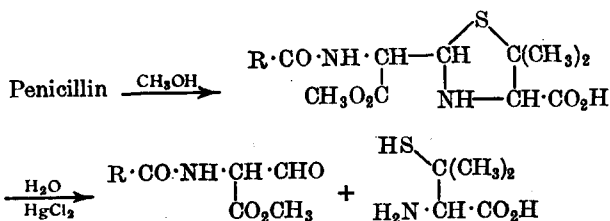

On the basis of the foregoing evidence, two structures are possible for penicillin, *viz.* III and IV.

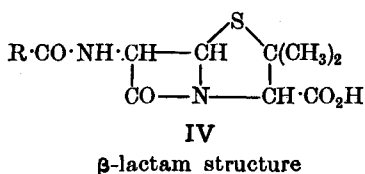
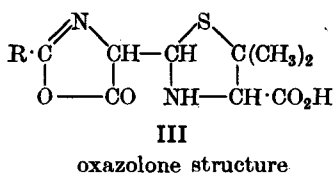

It was not possible to decide between these two on chemical evidence alone, since penicillin readily undergoes molecular rearrangements, *e.g.*, on treatment with dilute acid, penicillin rearranges to penillic acid. It was therefore necessary to examine the molecule by physical methods (thereby leaving the molecule intact).

(i) Infra-red spectra studies showed the presence of two double bonds; these were exclusive of the C=O group in the carboxyl group in penicillin. The examination of the infra-red spectra of a number of oxazolones (these contain two double bonds, C=O and C=N) showed that this ring structure could not account for the absorption maxima obtained for penicillin. Thus structure III is untenable. On the other hand, it was found from an

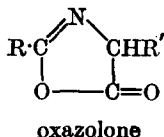

examination of the spectra of a number of amides that an amide structure could account for the spectrum of penicillin; thus IV is the probable structure of penicillin.

(ii) The X-ray analysis of the sodium, potassium and rubidium salts of benzylpenicillin showed the presence of a  $\beta$ -lactam ring; thus IV is the structure of penicillin.

Using this structure, we can now formulate the chemical reactions described above.

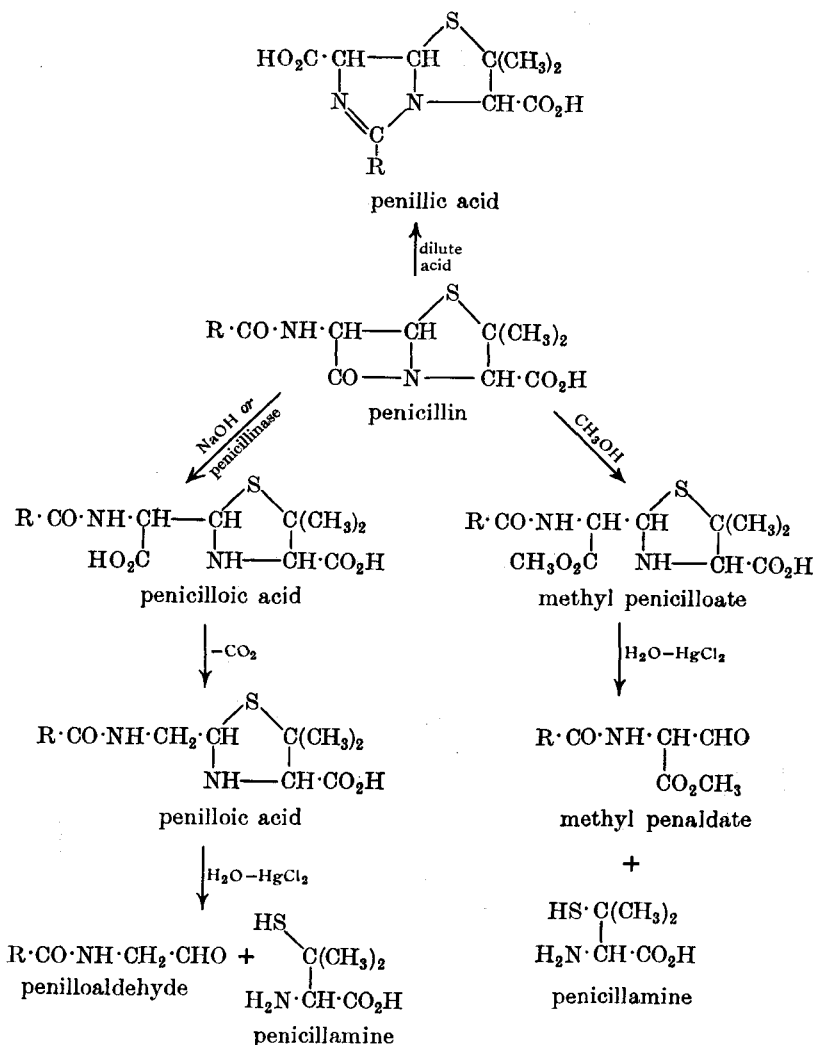

Penicillin has been synthesised by condensing synthetic D-penicillamine with a suitably substituted oxazolone containing a potential aldehyde group, e.g.,

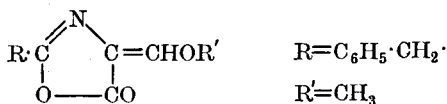

**§6b. "Synthetic" penicillins.** It has been found that most strains of staphylococci are highly sensitive to penicillin, but after a time these strains become resistant. This result has been shown to be due to the fact that these resistant strains produce the enzyme penicillinase which converts penicillin into the inactive penicilloic acid (see §6a).

Of all the natural penicillins, benzylpenicillin (penicillin G) is still the best. It has been recently found that different types of penicillin are produced by *Penicillium chrysogenum* when the cultural conditions are changed.

Batchelor *et al.* (1959) isolated pure 6-aminopenicillanic acid from fermentation liquors to which *no* precursors had been added. This acid had already been synthesised by Sheehan (1958); it is the amino-compound (I) with the RCO group removed.

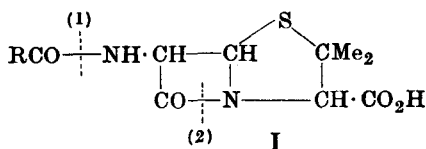

It has also been shown that (1) is the site of action of the enzyme penicillin amidase (Rolinson *et al.*, 1960; Claridge *et al.*, 1960) and, as mentioned above, (2) is the site of action of penicillinase.

Many "synthetic" penicillins have now been prepared (by the method described in §6).  $\alpha$ -Aminobenzylpenicillin (Rolinson *et al.*, 1961) has been synthesised and shows considerable activity against many organisms against which benzylpenicillin is not very effective. 6-Aminopenicillanic acid itself has also been used as the starting point of many new penicillins either chemically or by means of amidases.

**§6c. Biosynthesis of penicillins.** This has been studied and much progress has been made; the structure of penicillin can be dissected into an acid, cysteine, and valine.

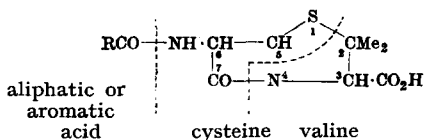

(a) *Side-chain precursors* (R·CO). Various aliphatic and aromatic acids have been used (see above and §6).

(b) *Precursors of the thiazolidine- $\beta$ -lactam ring system.* The use of labelled compounds has shown that (i) L-cystine (or cysteine), and (ii) L-valine are precursors of penicillin. Bentley *et al.* (1961) have also shown that malonate functions as a part-precursor of penicillic acid.

**§7. Streptomycin.** Streptomycin was isolated by Waksman *et al.* (1944) from cultures of *Streptomyces griseus*. This antibiotic is very effective in the treatment of tuberculosis, meningitis and pneumonia. Streptomycin is a solid with a laevorotation, and its structure has been shown to be composed of the three units streptose, I, *N*-methyl-L-glucosamine, II, and streptidine, III.

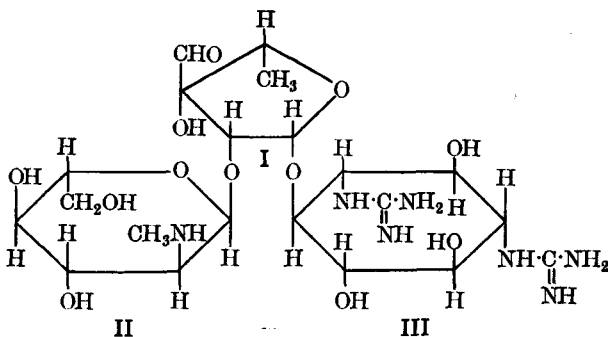

The following is a very brief account of the evidence that led to this structure for streptomycin. The molecular formula was shown to be  $C_{21}H_{39}O_{12}N_7$ . Three nitrogen atoms are strongly basic (the molecule forms a trihydrochloride), and on mild acid hydrolysis, streptomycin gives one molecule of streptidine,  $C_8H_{18}O_4N_6$ , and one molecule of streptobiosamine,  $C_{13}H_{23}O_8N$  (Folkers *et al.*, 1945).

**Streptidine** (unit III), on oxidation with potassium permanganate, gave two molecules of guanidine (Peck *et al.*, 1946); thus two guanido groups are present in streptidine. Streptidine, on alkaline hydrolysis, gave **streptamine** and ammonia (Brink *et al.*, 1945). Streptamine was shown to be

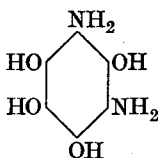

streptamine

a diaminotetrahydroxycyclohexane, and examination of the oxidation products of dibenzoylstreptamine with periodic acid led to the suggestion that streptidine is 1:3-diguanido-2:4:5:6-tetrahydroxycyclohexane (Carter *et al.*, 1946). Streptidine has been synthesised from streptamine (Wolfrom *et al.*, 1948). Since streptidine is not optically active, the configuration of the molecule must be *meso*, with the two guanido groups *cis* (see unit III).

**N-Methyl-L-glucosamine** (unit II). When streptomycin is treated with methanolic hydrogen chloride (methanolysis), and then subjected to acid hydrolysis followed by acetylation, the penta-acetate of *N*-methyl-L-glucosamine is obtained; the parent compound is obtained by hydrolysis. The structure of *N*-methyl-L-glucosamine was confirmed by synthesis from *L*-arabinose (Kuehl *et al.*, 1946, 1947).

**Streptose** (unit I). The streptose fragment has not been isolated from streptomycin by degradation. It appears to be too unstable, but its structure was elucidated by various degradative experiments, *e.g.*, the alkaline

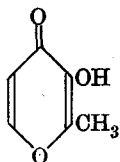

maltol

hydrolysis of streptomycin gives **maltol** (Schenck *et al.*, 1945), and this is produced by the conversion of a *furanose ring* into  $\gamma$ -pyrone.

**Streptobiosamine** (units I and II). Analytical work showed that this compound was a disaccharide, and from it was isolated *N*-methyl-L-glucosamine (see above). The formation of maltol and other analytical work led to the structure (I + II) for streptobiosamine, and then the points of attachment between streptobiosamine and streptidine were found, and so led to the structure given above for streptomycin (Kuehl *et al.*, 1947, 1948).

**§7a. Aureomycin and Terramycin.** Aureomycin was isolated from cultures of *Streptomyces aureofaciens*, and is used in the treatment of typhoid



fever, etc. Terramycin was isolated from cultures of *Streptomyces rimosus*, and is very effective in the treatment of trachoma. The structures of these antibiotics are (Woodward *et al.*, 1952):

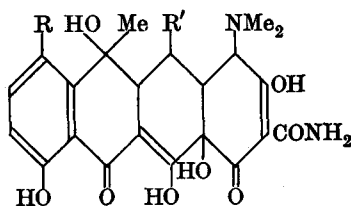

Aureomycin: R = Cl; R' = H  
 Terramycin: R = H; R' = OH

§8. **Patulin.** This has been obtained from various moulds. It is an optically inactive solid, and it inhibits Staphylococci and coliforms. The molecular formula of patulin is  $C_7H_6O_4$ ; it is a neutral substance and forms a monoacetate. Hydrolysis of patulin with acid produces one molecule of formic acid and a small yield (10 per cent.) of tetrahydro- $\gamma$ -pyrone-2-carboxylic acid (I). Catalytic reduction followed by further reduction with hydrogen iodide and red phosphorus gives 3-methylhexoic acid (II) and the lactone of 4-hydroxy-3-methylhexoic acid (III) [Birkinshaw *et al.*, 1943].

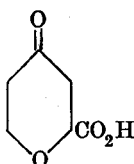

I

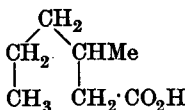

II

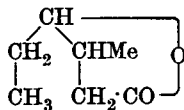

III

Woodward *et al.* (1949, 1950) have synthesised patulin as follows:

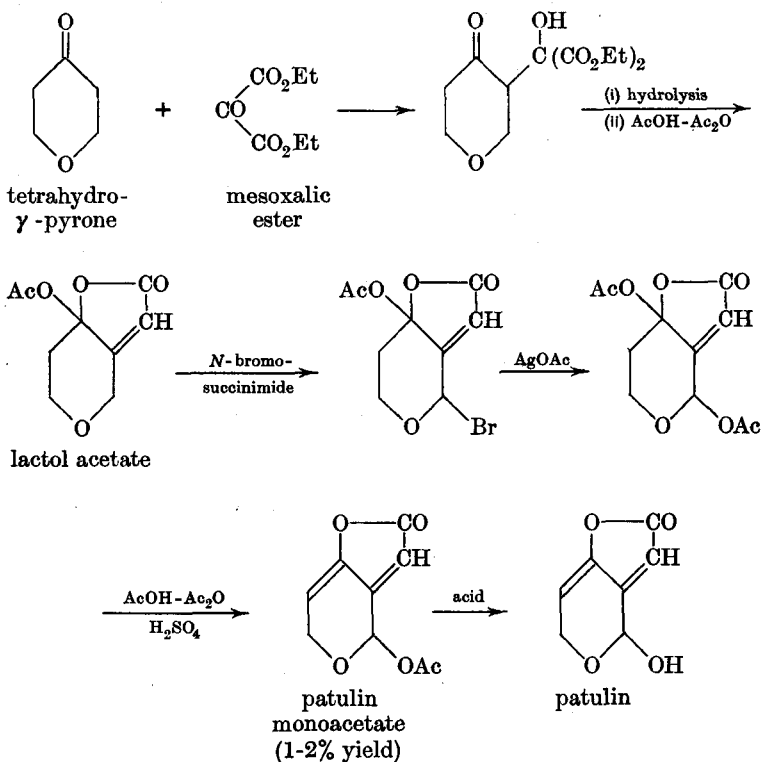

The monoacetate (obtained above) was shown to be identical with that obtained from patulin.

**§9. Chloramphenicol (Chloromycetin).** Chloramphenicol is a laevorotatory compound that is produced by *Streptomyces venezuelæ* (Carter *et al.*, 1948); it is very effective in the treatment of typhoid fever, etc.

The molecular formula of chloramphenicol is  $\text{C}_{11}\text{H}_{12}\text{O}_5\text{N}_2\text{Cl}_2$ , and its absorption spectrum is similar to that of nitrobenzene. The presence of a nitro-group was shown by the reduction of chloramphenicol with tin and hydrochloric acid, followed by diazotisation and then coupling to give an orange-red precipitate with 2-naphthol (Rebstock *et al.*, 1949). When catalytically reduced (palladium), chloramphenicol gives a product which has an absorption spectrum similar to that of *p*-toluidine, and the solution contains ionic chlorine. The hydrolysis of chloramphenicol with acid or alkali produces dichloroacetic acid and an optically active base,  $\text{C}_9\text{H}_{12}\text{O}_4\text{N}_2$ . This base was shown to contain a primary amino-group, and when treated with methyl dichloroacetate, the base reformed chloramphenicol (Rebstock *et al.*, 1949).

Chloramphenicol is converted into a diacetyl derivative on treatment with acetic anhydride in pyridine; the base obtained from chloramphenicol forms a triacetyl derivative on similar treatment. Thus chloramphenicol probably contains two hydroxyl groups. When the base is treated with periodic acid, two molecules of the latter are consumed with the formation of one molecule each of ammonia, formaldehyde and *p*-nitrobenzaldehyde.

These products may be accounted for if the base is assumed to be 2-amino-1-*p*-nitrophenylpropane-1 : 3-diol (Rebstock *et al.*, 1949).

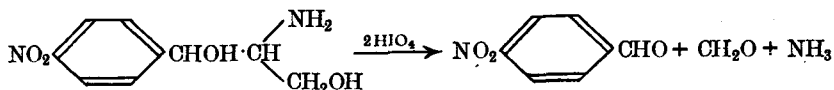

Thus chloramphenicol will be

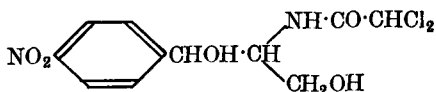

This structure has been confirmed by synthesis, *e.g.*, that of Long *et al.* (1949).

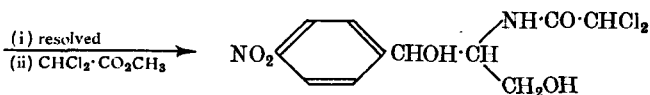
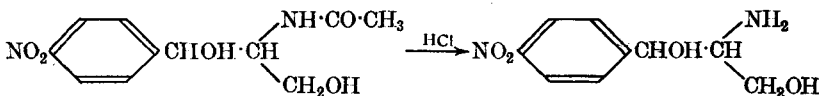
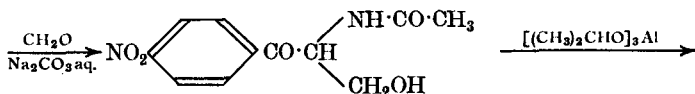
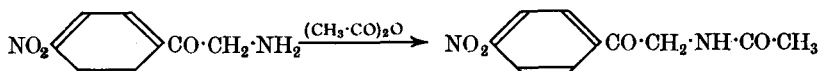
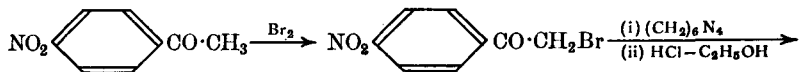

(-)-chloramphenicol

This structure has also been confirmed by crystallographic studies (Dunitz, 1952).

Chloramphenicol and the base contain two asymmetric carbon atoms; thus there are two possible pairs of enantiomorphs. Comparison of the properties of the base with those of norephedrine and nor-*ψ*-ephedrine (§7. XIV) showed that the configuration of the base was similar to that of nor-*ψ*-ephedrine (Rebstock *et al.*, 1949). Thus chloramphenicol is D-(-)-*threo*-2-dichloroacetamido-1-*p*-nitrophenylpropane-1 : 3-diol.

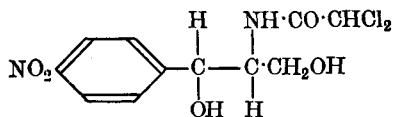

It is interesting to note that chloramphenicol is the first natural compound found to contain a nitro-group; the presence of the  $\text{CHCl}_2$  group is also most unusual.

## READING REFERENCES

- Gilman (Ed.), *Advanced Organic Chemistry*, Wiley. Vol. III (1953). (i) Ch. 5. Some Aspects of Chemotherapy. (ii) Ch. 6. Antibiotics.
- Raiziss and Gavron, *Organic Arsenical Compounds*, Chemical Catalog Co. (1923).
- Work and Work, *The Basis of Chemotherapy*, Oliver and Boyd (1948).
- Northey, *The Sulphonamides and Allied Compounds*, Reinhold (1948).
- Northey, Structure and Chemotherapeutic Activities of Sulphanilamide Derivatives, *Chem. Reviews*, 1940, **27**, 85.
- Haynes, Physiologically Active Unsaturated Lactones, *Quart. Reviews (Chem. Soc.)*, 1948, **2**, 46.
- Cook, The Chemistry of the Penicillins, *Quart. Reviews (Chem. Soc.)*, 1948, **2**, 203.
- The Chemistry of Penicillin*, Princeton University Press (1949).
- Knox, A Survey of New Penicillins, *Nature*, 1961, **192**, 492.
- Antibiotics*, Oxford Press (2 volumes; 1949).
- Robinson, *Antibiotics*, Pitman (1953).
- Waksman (Ed.), *Streptomycin*, Williams and Wilkins Co. (1949).
- Lemieux and Wolfrom, The Chemistry of Streptomycin, *Advances in Carbohydrate Chemistry*, Academic Press, 1948, **3**, 337.
- Brink and Folkers, Some Aspects of Streptomycin and Other *Streptomyces* Antibiotics, *Advances in Enzymology*, Interscience Publishers, 1950, **10**, 145.
- Birkinshaw, The Chemistry and Biochemistry of Streptomycin and Related Compounds, *J. Pharm. Pharmacol.*, 1951, **3**, 529.
- Rebstock *et al.*, Chloramphenicol, *J. Amer. Chem. Soc.*, 1949, **71**, 2458, 2463.
- Long *et al.*, Chloramphenicol, *J. Amer. Chem. Soc.*, 1949, **71**, 2469, 2473.
- Brink and Harman, Chemistry of Some Newer Antibiotics, *Quart. Reviews (Chem. Soc.)*, 1958, **12**, 93.
- Rose, A Chemotherapeutic Search in Retrospect, *J.C.S.*, 1951, 2770.
- Barber, Chance and Design in the Search for New Drugs, *Chem. and Ind.*, 1955, 1460.
- Burger, Rational Approaches to Drug Structure, *J. Chem. Educ.*, 1956, **33**, 362.
- Bracken, *The Chemistry of Micro-Organisms*, Pitman (1955).

HÆMOGLOBIN, CHLOROPHYLL AND  
PHTHALOCYANINES

§1. **Introduction.** Two of the most important compounds of the natural porphyrins are hæmoglobin and chlorophyll. The bile pigments, which are formed mainly in the liver, are degradation products of hæmoglobin. Hæmoglobin and chlorophyll act as catalysts (biological) in many biological processes.

## HÆMOGLOBIN

§2. **Degradation products of hæmoglobin.** Hæmoglobin occurs in all vertebrates (with certain exceptions) and in many invertebrates; it has also been found in certain strains of yeasts, moulds, etc. It is a chromo-protein (§7 B. XIII), the protein part being *globin* (94 per cent.), and the prosthetic group being *hæm* (6 per cent.). The composition of hæmoglobin varies slightly, depending on the species from which it is isolated; the variation occurs only in the globin part of the molecule. It is interesting to note that hæmoglobin was the first protein to be obtained in a crystalline form.

The way in which the globin part is bound to hæm has been the subject of much discussion. There appears to be agreement that the iron atom is bound to some part of the protein. The iron atom (bivalent) in hæm uses four co-ordination valencies in this molecule, and since iron has a co-ordination number of six, it is believed that it is these two valencies (which are perpendicular to the other four) that are joined to the globin molecule. Keilin (1960) has shown that only the basic nitrogen atoms in amino-acids can combine with hæm.

In the animal body, hæmoglobin readily combines with oxygen to form *oxyhæmoglobin*, and this, when treated with glacial acetic acid, forms *hæmatin*,  $C_{34}H_{32}O_4N_4Fe^{III}\cdot OH$ . The chloride of hæmatin is known as *hæmin*; its molecular formula is  $C_{34}H_{32}O_4N_4Fe^{III}Cl$  (the chlorine is ionised, and the iron atom is in the ferric state). Hæmin may be prepared by warming blood with acetic acid and sodium chloride (Teichmann, 1853). The iron can be removed from hæmin, and replaced. The iron-free compounds are known as *porphyrins*, and the iron-containing compounds as *hæms*; the nature of the porphyrin depends on the conditions which are used to remove the iron atom from hæmin. When hæmin is reduced with sodium hyposulphite, the base *hæm* is produced in which the atom of iron is in the bivalent state; the molecular formula of hæm is  $C_{34}H_{32}O_4N_4Fe$ .

Since hæmin forms a diester with methanol, the molecule therefore contains two carboxyl groups. Also, since hæmin absorbs two molecules of hydrogen when catalytically reduced (palladium), two ethylenic double bonds are thus probably present in the molecule. When subjected to vigorous reduction with hydriodic acid and phosphonium iodide or hydriodic acid and acetic acid, hæmin is degraded into the four pyrrole derivatives opopyrrole, I, hæmopyrrole, II, cryptopyrrole, III, and phyllopyrrole, IV. All four compounds have been synthesised by means of the Knorr pyrrole synthesis (1884, 1886); this is the condensation between an  $\alpha$ -aminoketone

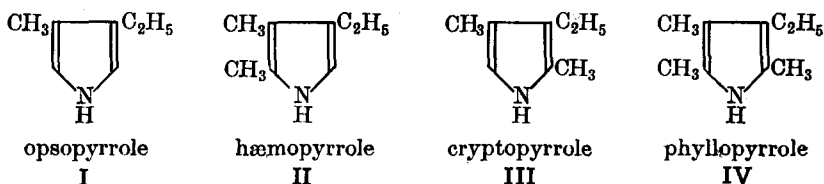

and a ketone containing an active methylene group, *i.e.*, a compound containing the group  $-\text{CH}_2\cdot\text{CO}-$ . The mechanism of the reaction is not known; possibly the enol forms are involved, and so we may write the general reaction as follows:

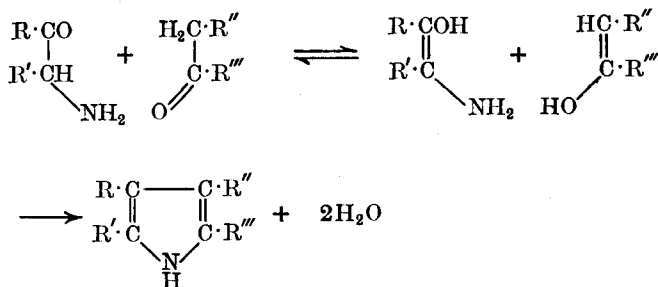

A detailed study of this reaction has shown that the yields depend on the nature of R, R', R'' and R'''; when R' and R'' are acyl or carbalkoxyl groups, the yields are usually very good. As examples of the Knorr synthesis, let us consider the preparation of opsopyrrole (I) and cryptopyrrole (III). Opsopyrrole may be synthesised by condensing aminoacetone with ethyl 2:4-diketopentanoate, and then subjecting the product to the Wolff-Kishner reduction, *i.e.*, first converting the product into the hydrazone and then heating the latter with sodium ethoxide at  $160^\circ$ . By this means a keto-group is converted into a methylene group (see also Vol. I). By using an excess of sodium ethoxide, decarboxylation is also effected at the same time.

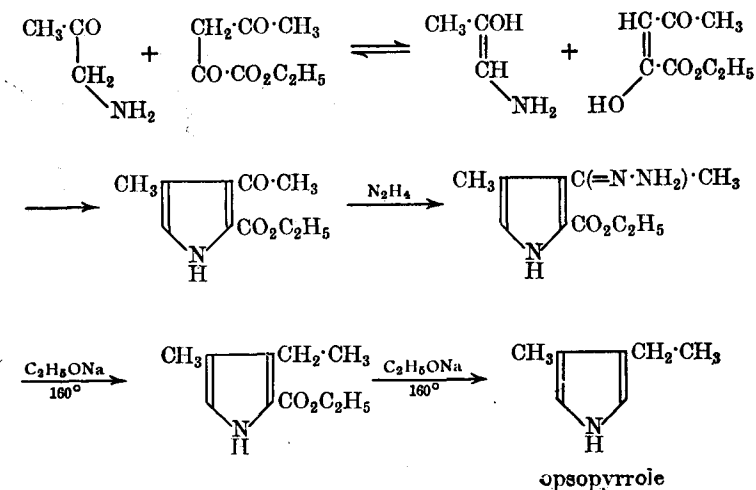

Cryptopyrrole may be prepared in a similar manner, starting from ethyl  $\alpha$ -aminoacetoacetate and acetylacetone (penta-2 : 4-dione).

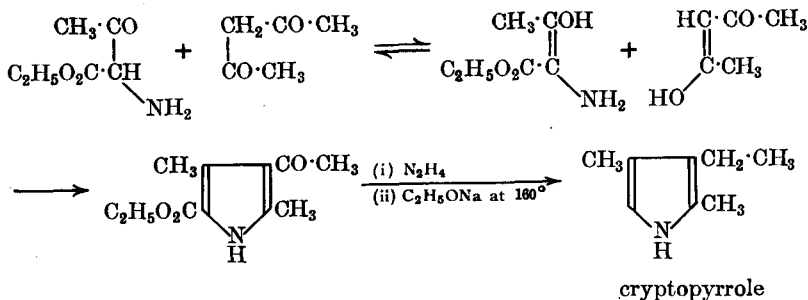

When reduced with tin and hydrochloric acid, hæmin is again degraded into four pyrrole derivatives, but in this case the products are all carboxylic acids in which each of the four pyrroles I-IV contains a carboxyl group attached to the ethyl group:

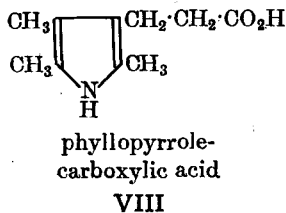
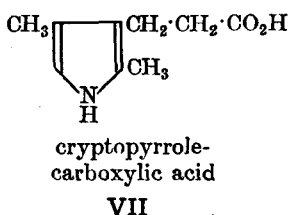
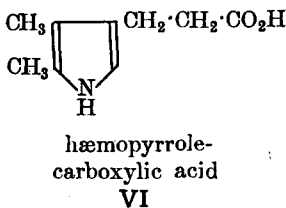
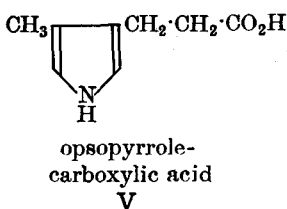

When oxidised with chromic acid, hæmin gives two molecules of *hæmatinic acid* (IX). On the other hand, *mesoporphyrin* (see below) gives, on oxidation, two molecules of ethylmethylemaleimide (X).

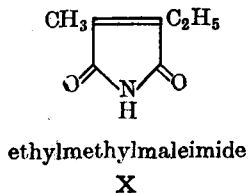
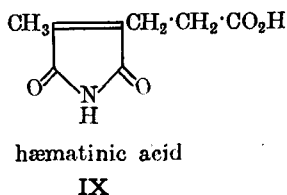

The treatment of hæmin with iron dust and formic acid results in the removal of the iron atom and the formation of *protoporphyrin*,  $\text{C}_{34}\text{H}_{34}\text{O}_4\text{N}_4$ . The iron atom is also removed from hæmin by the action of hydrobromic acid in acetic acid, but in this case the product is *hæmatoporphyrin*,  $\text{C}_{34}\text{H}_{38}\text{O}_6\text{N}_4$ . If, however, hæmin is treated with hydriodic acid in acetic acid, the iron atom is again removed and *mesoporphyrin*,  $\text{C}_{34}\text{H}_{38}\text{O}_4\text{N}_4$ , is obtained.

Finally, when porphyrins containing two carboxyl groups are decarboxylated, the products obtained (after reduction, if necessary) are known as

*ætioporphyrins*, e.g., when protoporphyrin is decarboxylated, and the product then reduced, the final product is *ætioporphyrin*,  $C_{38}H_{38}N_4$ , which is also a degradation product of chlorophyll. Thus hæmin and chlorophyll are closely related chemically.

The table summarises the reactions that have been discussed.

Compound	Reaction	Products
Hæmoglobin . . .	Atmospheric oxidation	Oxyhæmoglobin
Oxyhæmoglobin . .	$CH_3 \cdot CO_2H$	Hæmatin
Oxyhæmoglobin . .	$CH_3 \cdot CO_2H + NaCl$	Hæmin
Hæmin . . . . .	$Na_2S_2O_4$	Hæm
Hæmin . . . . .	$HI + PH_4I$	Osopyrrole, Hæmopyrrole, Cryptopyrrole and Phyllopyrrole
Hæmin . . . . .	$Sn-HCl$	Opsopyrrole-, Hæmopyrrole-, Cryptopyrrole- and Phyllopyrrole- carboxylic acids
Hæmin . . . . .	$CrO_3-H_2SO_4$	Hæmatinic acid
Mesoporphyrin . .	$CrO_3-H_2SO_4$	Ethylmethylemaleimide
Hæmin . . . . .	$Fe-H \cdot CO_2H$	Protoporphyrin
Hæmin . . . . .	$HBr-CH_3 \cdot CO_2H$	Hæmatoporphyrin
Hæmin . . . . .	$HI-CH_3 \cdot CO_2H$	Mesoporphyrin
Porphyrin . . . .	Decarboxylation (and then reduction, if necessary)	Ætioporphyrins

From the foregoing evidence (the molecular formula and the degradation products of hæmin), it is reasonable to infer that hæmin contains four substituted pyrrole nuclei linked together. The isolation of the pyrroles I-IV suggests that each of the four pyrrole nuclei contains a methyl group in the  $\beta$ -position. The isolation of the oxidation products IX and X (oxidation at the  $\alpha$ -position), and of the reduction products I-VIII (appearance of a methyl group at the  $\alpha$ -position), suggests that the pyrrole nuclei are linked at the  $\alpha$ -positions *via* one carbon atom. The isolation of two molecules of IX suggests the presence of two propionic acid residues each in the  $\beta$ -position of two pyrrole nuclei (this would also account for the two carboxyl groups present in hæmin). The appearance of ethyl groups in I-IV on the reduction of hæmin could be explained by the presence of two vinyl groups in the  $\beta$ -position of two pyrrole nuclei (hæmin contains two ethylenic double bonds). A possible structure for hæmin is thus a ring structure containing four pyrrole nuclei linked at the  $\alpha$ -positions *via* one carbon atom, with four  $\beta$ -positions occupied by methyl groups, two  $\beta'$ -positions by vinyl groups and the remaining two  $\beta'$ -positions by propionic acid residues. Küster (1912) was the first to propose that the four pyrrole nuclei formed a cyclic structure, and this has been proved correct by synthetic work; the porphyrins so obtained had the same absorption spectra as the natural porphyrins. At the same time, this synthetic work established the nature and the positions of the substituent groups.

The parent substance of all the compounds mentioned above is *porphin* (XI), and this may conveniently be written as XII (H. Fischer). In this porphin molecule there is an eighteen-membered ring containing a complete arrangement of conjugated double bonds. Thus many resonating structures contribute to this molecule, and consequently its stability will be great; this is observed in practice, e.g., the molecule has a very large heat of combustion. Also, the resonance gives rise to the colour in porphin derivatives (see Ch. XXXI, Vol. I); porphin itself does not occur naturally. It has been shown, by analogy with the X-ray data on phthalocyanines (§9), that the



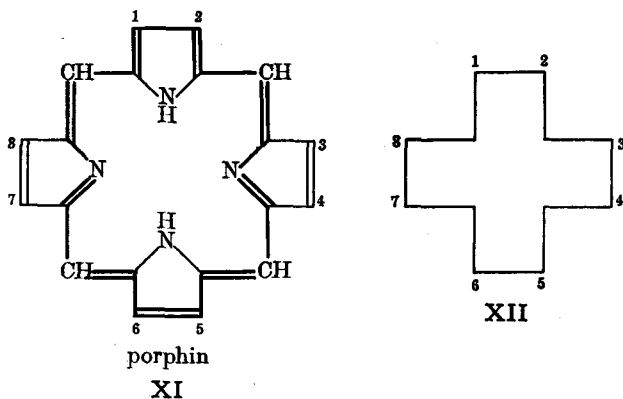

porphin molecule is planar, and this planar structure is also in agreement with magnetic measurements.

The *ætioporphyrins*,  $C_{32}H_{38}N_4$ , are derivatives of porphin in which the 3- and 4-positions of each pyrrole nucleus are substituted by methyl and ethyl groups. Four isomers are possible, and these are known as *ætioporphyrin I, II, III and IV*, respectively.

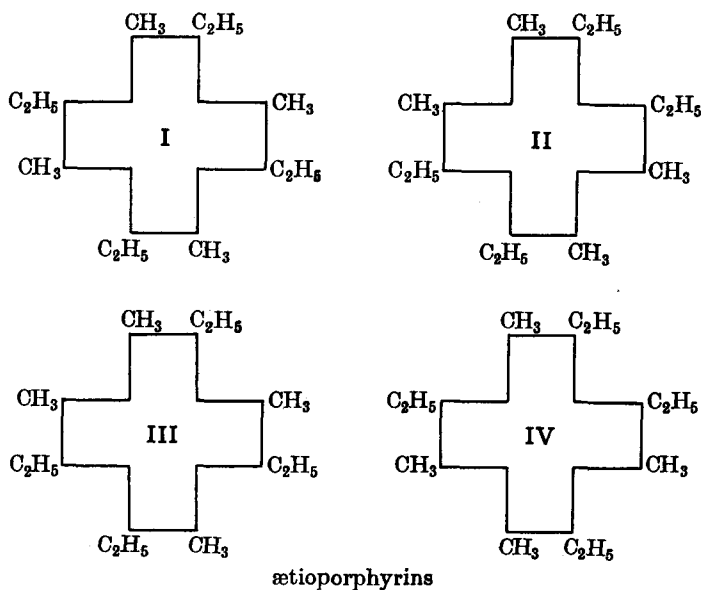

All four *ætioporphyrins* have been synthesised; the degradation of hæmin gives *ætioporphyrin III*.

**§3. Synthesis of the porphyrins.** The first step in the synthesis of porphyrins is the synthesis of the dipyrrylmethenes.

(i) Dipyrrylmethenes may be prepared by the bromination of a *2-methylpyrrole in which position 5 is vacant* (H. Fischer, 1915); at least two products are obtained, e.g., cryptopyrrole gives compounds I and II.

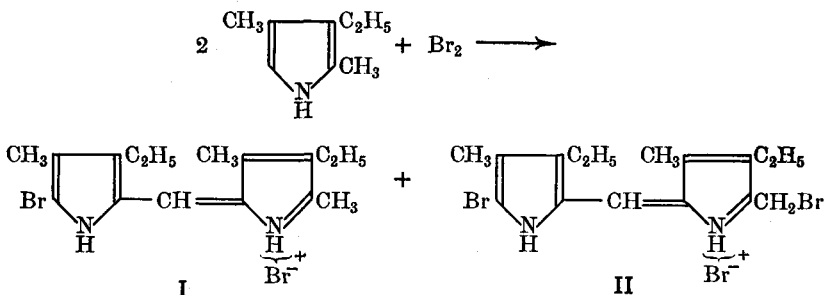

According to Corwin *et al.* (1944), the mechanism of this reaction is:

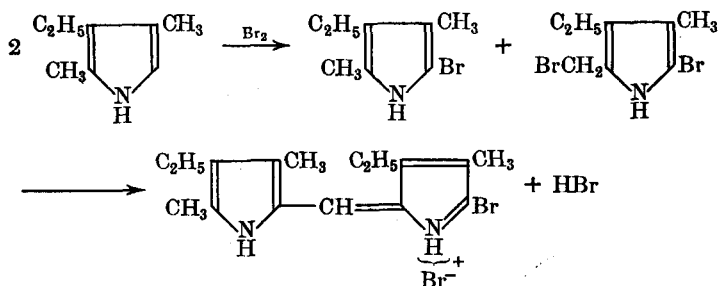

(ii) When pyrroles, in which the 5-position is vacant, are coupled by means of formic acid in the presence of hydrobromic acid, dipyrlylmethenes are produced (H. Fischer *et al.*, 1922); *e.g.*,

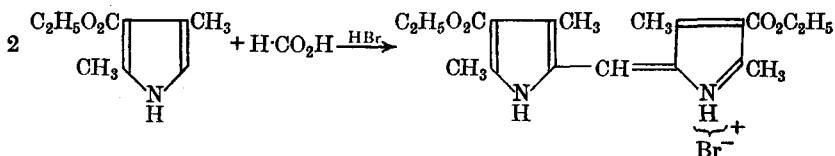

(iii) Piloty *et al.* (1914) showed that dipyrlylmethanes may be oxidised to the corresponding methenes by means of bromine, *e.g.*,

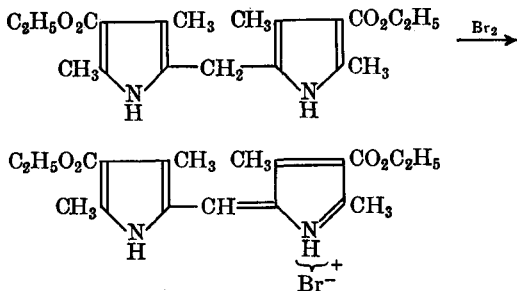

H. Fischer *et al.* (1923) modified the above procedure as follows. A dipyrlylmethane containing carboxyl groups was first prepared, this then hydrolysed and then treated with bromine in acetic acid. In this way the methene

derivative is oxidised to the methene compound, but at the same time the carboxyl groups in position 5:5' are replaced by bromine atoms, *e.g.*,

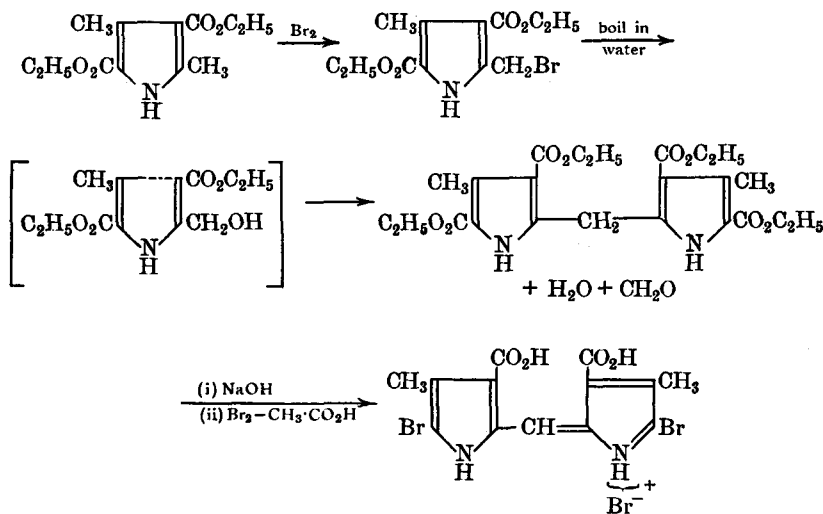

(iv) The foregoing methods (except i) lead to the formation of *symmetrical* dipyrromethenes. The preparation of *unsymmetrical* dipyrromethenes is best carried out as follows, using the Gattermann aldehyde synthesis (Piloty *et al.*, 1912, 1914; H. Fischer *et al.*, 1926); *e.g.*,

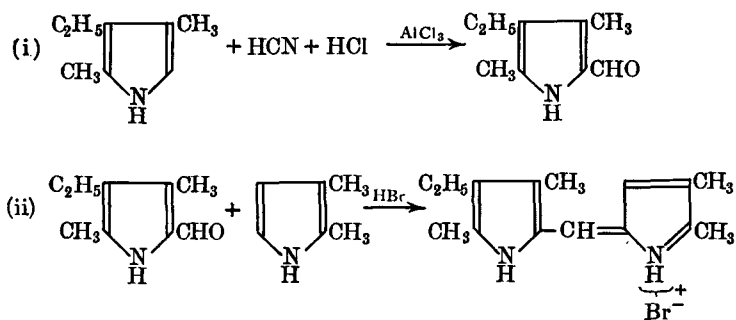

The dipyrromethenes are coloured solids. H. Fischer *et al.* (1926) then prepared porphyrins by condensing two molecules of a dipyrromethene by heating with succinic acid at 220°, *e.g.*, ætioporphyrin I. Porphin itself was synthesised by H. Fischer *et al.* (1935) by boiling pyrrole-2-aldehyde with

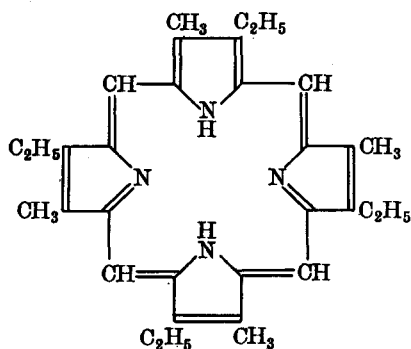
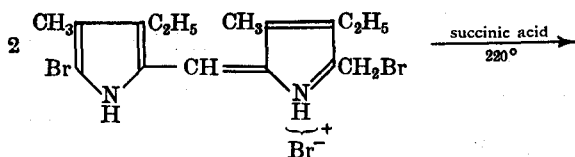

aetioerythrin I

formic acid and ethanol. A later synthesis is by heating pyrrole with formaldehyde in the presence of a mixture of methanol and pyridine (Rothe-mund, 1936, 1939; Calvin *et al.*, 1943).

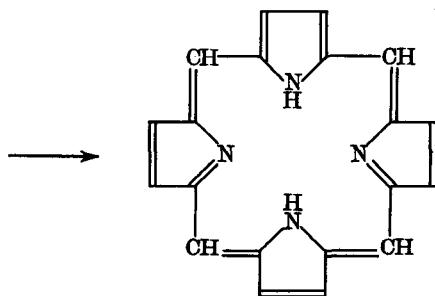
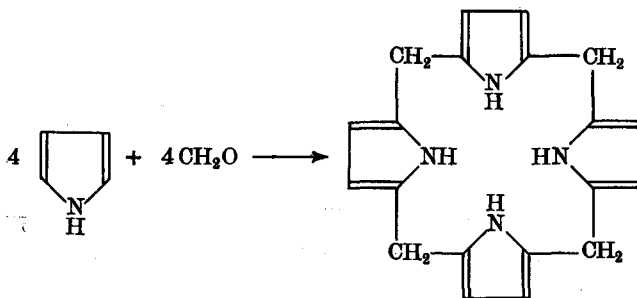

porphin

It should be noted that the two imino hydrogen atoms are replaced by the iron atom in the hæms, and the iron atom is covalently bound.

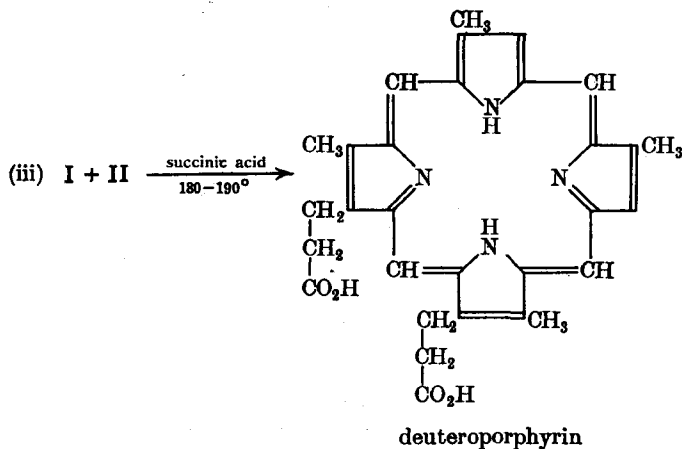
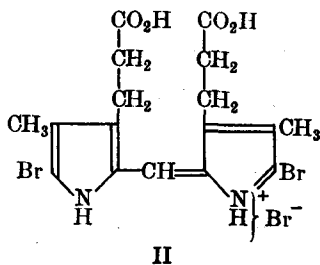
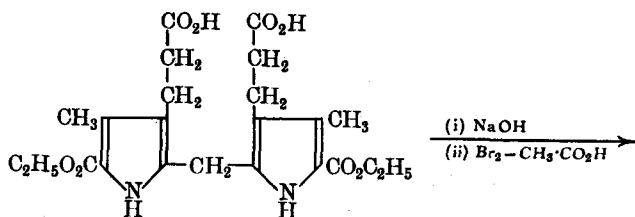
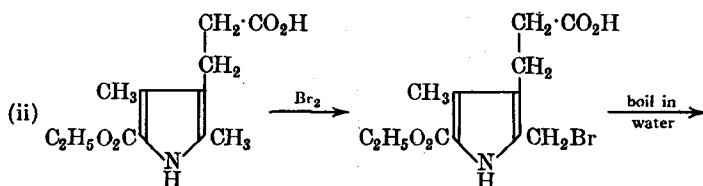
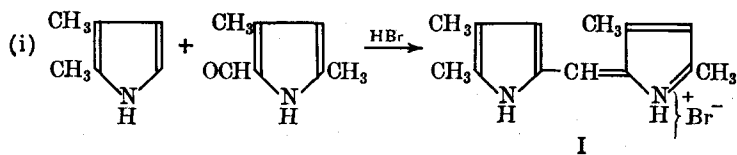
§4. Synthesis of hæmin (H. Fischer *et al.*, 1929).

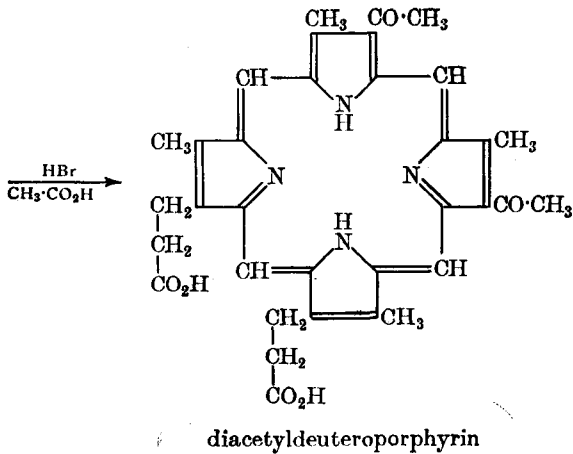
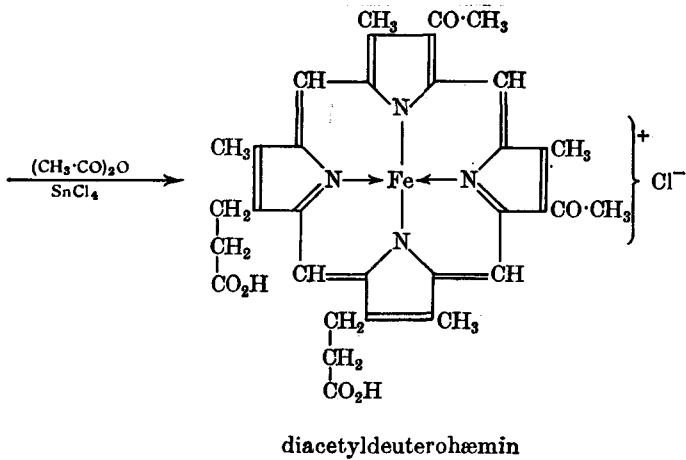
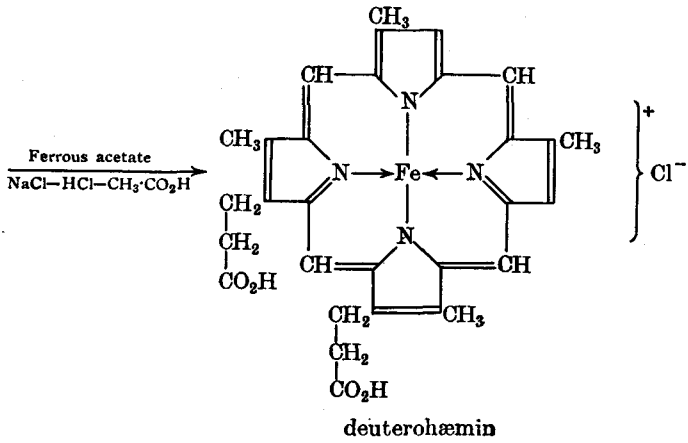

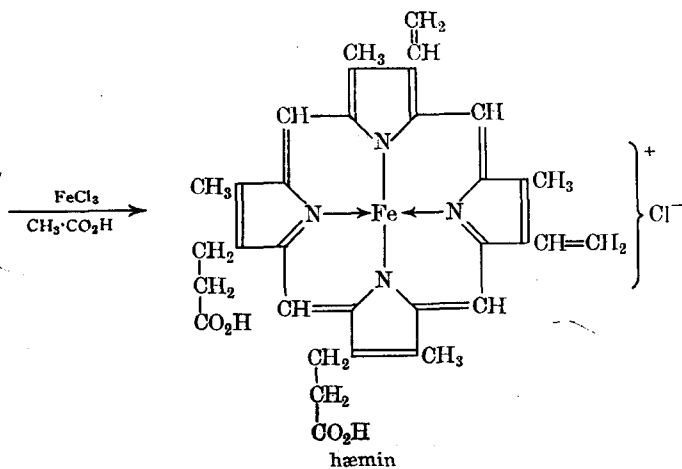
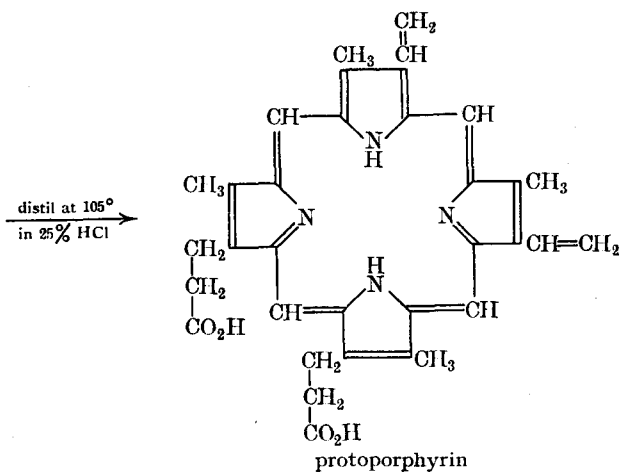
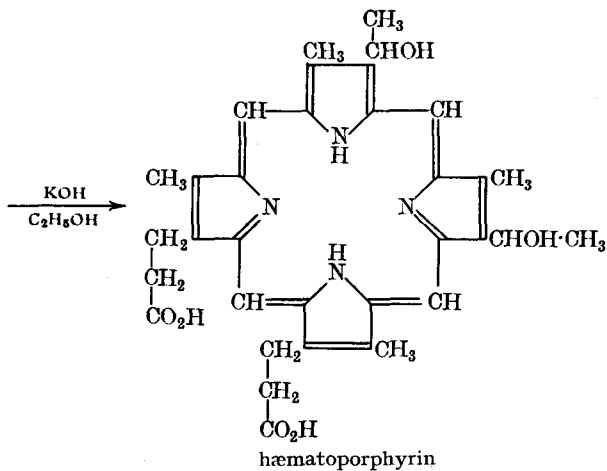

It should be noted that the introduction of the iron atom into deuteroporphyrin to give deuterohæmin renders the pyrrole nuclei more reactive.

**§4a. Biosynthesis of porphyrin.** The progress made in this field is one of the outstanding examples of the use of isotopes. Tracer syntheses *in vivo* and *in vitro* and degradation methods have established the origin of all the carbon and nitrogen atoms in protoporphyrin (of hæm), and have also established the nature of the pyrrole precursors. These results are the outcome of a large volume of work, but in the following account only a few experiments have been mentioned. These indicate, to some extent, the lines of research pursued.

Bloch *et al.* (1945), using acetic acid labelled with deuterio atoms, showed that deuterohæmin was produced. Thus at least the methyl carbon of acetic acid is involved in the biosynthesis of hæm. Then Shemin *et al.* (1950) and Neuberger *et al.* (1950) carried out experiments with  $^{14}\text{CH}_3\cdot\text{CO}_2\text{H}$  and  $\text{CH}_3\cdot^{14}\text{CO}_2\text{H}$ , and showed that *both* carbon atoms of acetate participate in the synthesis of hæm. The latter authors also showed that with  $^{14}\text{CH}_3\cdot\text{CO}_2\text{H}$ , about half of the radioactive tracer atom appeared in the two pyrrole nuclei carrying the vinyl radicals, and the other half in the two pyrrole nuclei carrying the propionic acid residues. When, however,  $\text{CH}_3\cdot^{14}\text{CO}_2\text{H}$  was used as the precursor, then about 20 per cent. of the tracer atom appeared in the vinyl pyrrole nuclei and 80 per cent. in the propionic acid pyrrole nuclei. In neither case of the labelled acetates was there any significant radioactivity in the methine carbon of the hæm. Thus the carbons of the methine bridges do not originate from acetate.

Shemin *et al.* (1945, 1946) carried out experiments with  $^{15}\text{N}$  glycine, and showed that all the nitrogen atoms in hæm are derived from this glycine. Shemin *et al.* (1950) also used  $\text{CH}_2\cdot\text{NH}_2\cdot^{14}\text{CO}_2\text{H}$ , and showed that the carbonyl group of glycine is *not* incorporated into protoporphyrin. On the other hand, Altman *et al.* (1948), using  $^{14}\text{CH}_2\cdot\text{NH}_2\cdot\text{CO}_2\text{H}$ , showed that the  $\alpha$ -carbon atom of glycine is used in the protoporphyrin synthesis. This was confirmed by Shemin *et al.* (1950) who used  $^{14}\text{CH}_2\cdot^{15}\text{NH}_2\cdot\text{CO}_2\text{H}$  and showed that for each nitrogen used for hæm synthesis, two  $\alpha$ -carbon atoms of glycine were also incorporated into the molecule. Similar results were obtained by Neuberger *et al.* (1950) who also showed that the  $\alpha$ -carbon atom of glycine is used in the formation of the methine bridge. Thus all the carbon atoms of protoporphyrin, except eight derived from the  $\alpha$ -carbon of glycine, originate from acetate. Furthermore, a detailed study of the degradation products of the labelled protoporphyrins showed that it was very probable that the two sides of the pyrrole nuclei were synthesised from identical intermediates. It also seemed very reasonable that a *common*

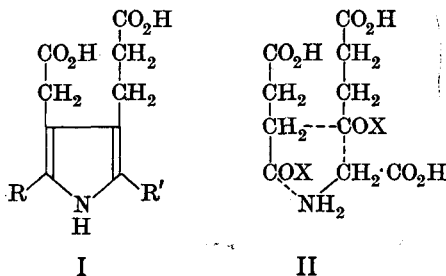

pyrrole of the type I was formed first. Also, consideration of the distribution of the radioactivity of the carbon atoms of the propionic acid residue and the (pyrrole) nuclear carbon to which it was attached led to the suggestion



that succinic acid was a precursor, and that two molecules of this, on condensation with one molecule of glycine, could form the common pyrrole (I). The tracer distribution of the labelled succinic acid could arise by acetate entering the *Krebs cycle* (§18. XIII). Two molecules of "active" succinate

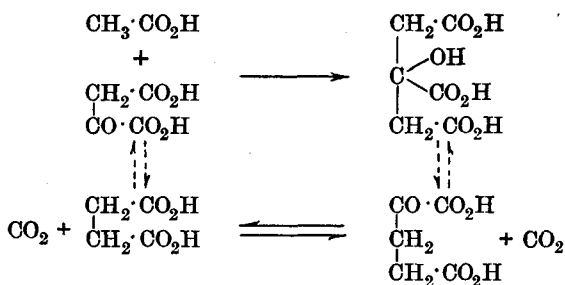

(succinyl-coenzyme A) and one of glycine then forms the common precursor (see II). Shemin *et al.* (1952) tested this succinic acid hypothesis by using  $^{14}\text{CO}_2\text{H} \cdot \text{CH}_2 \cdot \text{CH}_2 \cdot ^{14}\text{CO}_2\text{H}$  and  $\text{CO}_2\text{H} \cdot ^{14}\text{CH}_2 \cdot ^{14}\text{CH}_2 \cdot \text{CO}_2\text{H}$ , and showed that hæm contained the labelled carbon.

In 1952, Westall isolated porphobilinogen from the urine of humans suffering from acute porphyria. Based on this, Shemin *et al.* (1953) now proposed that  $\delta$ -aminolævulic acid can replace "active" succinate and glycine in porphyrin synthesis:

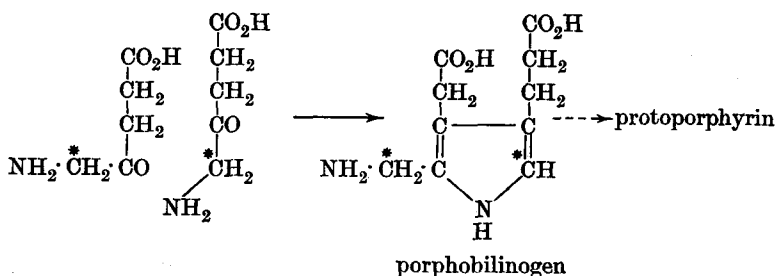

This pyrrole synthesis is supported by various experiments, *e.g.*, Shemin *et al.* (1954) used  $[\delta^{14}\text{C}]\delta$ -aminolævulic acid as precursor, and showed that half of the radioactivity is equally distributed among the four pyrrole nuclei and the other half is in the methine-bridge carbons. This distribution is in agreement with the equation given. Furthermore, Falk *et al.* (1953) have shown that porphobilinogen is the common precursor in porphyrin synthesis.

The problem of the conversion of porphobilinogen into protoporphyrin has still to be elucidated. There is evidence to show that porphobilinogen is first converted mainly into uroporphyrinogen III (this is ætioporphyrin III (§2) with  $\text{Me} = \cdot\text{CH}_2 \cdot \text{CO}_2\text{H}$  and  $\text{Et} = \cdot\text{CH}_2 \cdot \text{CH}_2 \cdot \text{CO}_2\text{H}$ ) by certain enzymes, and then this compound is converted into protoporphyrin by enzymes. Decarboxylation of the acetic acid radicals would produce the methyl radicals (in protoporphyrin). The conversion of the propionic acid residues into vinyl radicals takes place by a series of steps; a possibility is:

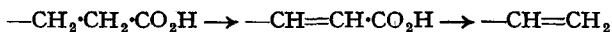

§5. **Bile pigments.** Several pigments occur in bile, *e.g.*, bilirubin, mesobilirubin, etc.; the most important one is **bilirubin**,  $\text{C}_{33}\text{H}_{36}\text{O}_6\text{N}_4$ . On vigorous

oxidation, bilirubin gives hæmatinic acid; and on vigorous reduction, it gives cryptopyrrole and cryptopyrrolecarboxylic acid. When catalytically reduced, bilirubin gives mesobilirubin,  $C_{33}H_{40}O_6N_4$ , which, on reduction with hydriodic acid in acetic acid, forms, among other products, bilirubic acid,  $C_{17}H_{24}O_3N_2$ , and neobilirubic acid,  $C_{16}H_{22}O_3N_2$ . Finally, the reduction of bilirubic acid gives cryptopyrrolecarboxylic acid as the main product, and the reduction of neobilirubic acid gives hæmopyrrolecarboxylic acid. From this evidence it is reasonable to conclude that bilirubin contains the four pyrrole nuclei that occur in hæmoglobin. Furthermore, there is much evidence to show that bilirubin is a degradation product of hæmoglobin.

Since the absorption spectrum of bilirubin is not like that of a porphyrin, it is assumed that bilirubin has an *open-chain* structure. Further degradative and synthetic work has shown that bilirubin probably has the following structure.

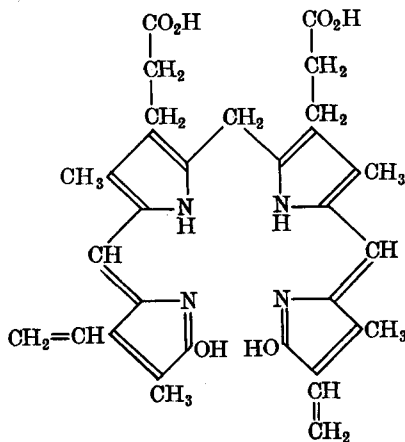

bilirubin

### CHLOROPHYLL

**§6. Introduction.** Chlorophyll is the green colouring matter of leaves and green stems, and its presence is essential for photosynthesis. Photosynthesis is the process in which light energy is used by plants to synthesise carbohydrates, proteins and fats. In green plants it is the chlorophyll which absorbs the light energy.

The name *chlorophyll* was given to the green pigment in leaves by Pelletier and Caventou (1818). There the matter rested until 1864, when Stokes showed, from spectroscopic evidence, that chlorophyll was a mixture. This paper apparently did not attract much attention, and it was not until Willstätter entered the field that any progress in the chemistry of chlorophyll was made.

When dried leaves are powdered and then digested with ethanol, a "crystalline" chlorophyll is obtained after concentration of the solvent. If, however, ether or aqueous acetone is used instead of ethanol, then the product is "amorphous" chlorophyll (Willstätter *et al.*, 1908). The extraction of chlorophyll is also accompanied by the extraction of two other pigments, carotene and xanthophyll (see Ch. IX). Willstätter *et al.* (1910) then showed that "crystalline" chlorophyll was produced during the extraction of chlorophyll by means of ethanol, a molecule of phytol alcohol being replaced by ethanol under the influence of an enzyme, chlorophyllase (which is present in leaves). Nettle leaves are the main source for the extraction of chlorophyll on a large scale.

Willstätter *et al.* (1911) originally gave chlorophyll the molecular formula  $C_{55}H_{72}O_6N_4Mg$ , but in 1912 Willstätter *et al.* showed that chlorophyll, obtained from a wide variety of sources, was a mixture of two compounds, chlorophyll-*a* and chlorophyll-*b*. The separation was effected by shaking a light petrol solution of chlorophyll with aqueous methanol; chlorophyll-*a* remains in the light petrol, and chlorophyll-*b* passes into the aqueous methanol. Chlorophyll-*a* is a bluish-black solid, giving a green solution in organic solvents; chlorophyll-*b* is a dark green solid, also giving a green solution in organic solvents. The two components occur in proportions of approximately 3 of *a* to 1 of *b* in natural chlorophyll. Winterstein *et al.* (1933) have separated the two chlorophylls by means of chromatography (on sucrose as adsorbent). This technique has been improved by various workers (*inter alia*, Calvin *et al.*, 1962).

The molecular formulæ that have been assigned to chlorophyll-*a* and chlorophyll-*b* are  $C_{55}H_{72}O_5N_4Mg$  and  $C_{55}H_{70}O_6N_4Mg$ , respectively (Willstätter, 1913); the two compounds have different absorption spectra (*cf.* Stokes, above). The hydrolysis of both chlorophylls with cold dilute potassium hydroxide solution gives one molecule of phytol,  $C_{20}H_{40}O$  (see §30. VIII), one molecule of methanol, and one molecule of chlorophyllide-*a* (chlorophyllin-*a*), I, or chlorophyllide-*b* (chlorophyllin-*b*), II. Thus the chlorophylls are di-esters. When either chlorophyll is heated with an ethanolic solution of hydrated oxalic acid, the magnesium atom is replaced by two hydrogen atoms to produce phytyl phæophorbide-*a* (III) or *b* (IV; these phytyl phæophorbides are also known as phæophytins *a* and *b*, and "crystalline" chlorophyll is ethyl chlorophyllide). The foregoing reactions may be formulated as follows:

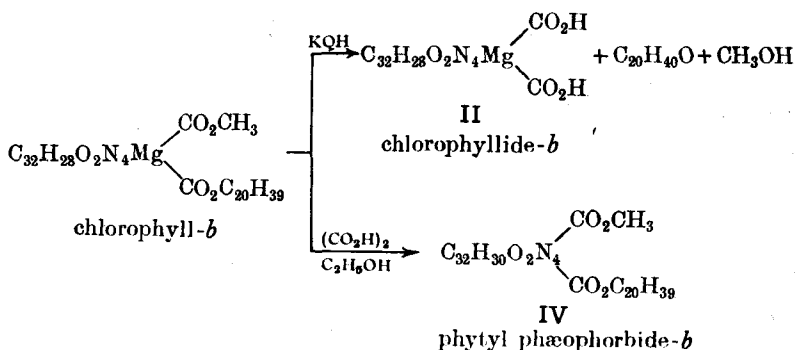
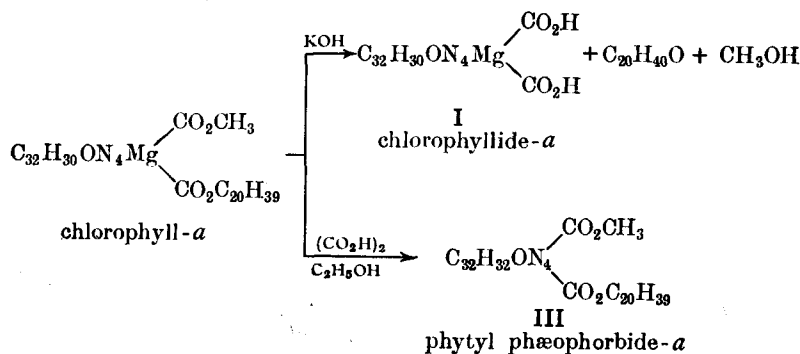

§6a. **Nomenclature of the chlorophyll degradation products.** Porphyrins are substituted porphins (see §2). Phyllins, phyllides and chlorophylls contain magnesium, whereas phorbins, phorbides and phytins are magnesium-free compounds, the magnesium atom having been removed and replaced by two hydrogen atoms. 7 : 8-Dihydroporphin is the nucleus of the *chlorin* series of compounds (tricarboxylic derivatives) which are derived from chlorophyll-*a*; *rhodins* are the corresponding compounds derived from chlorophyll-*b*. The introduction of the extra ring—two methylene groups across the 6 :  $\gamma$ -positions (see §7)—gives rise to the *phorbins*. The prefix *phæo* designates those compounds which have the same substituents that occur in chlorophyll. Chlorin itself is dihydroporphin, and the natural *red* porphyrin pigments are derivatives of porphin, whereas the *green* chlorophylls and their derivatives are derivatives of chlorin. Furthermore, examination of formulæ XIV and XV (in §7) shows that there is still complete conjugation in chlorin as in porphin (formula XI, §2). Chlorin has been synthesised by Linstead *et al.* (1955), and has been dehydrogenated to porphin.

§7. **Structure of chlorophyll-*a*.** When phytyl phæophorbide-*a* is hydrolysed with boiling methanolic potassium hydroxide (30 seconds), the product is chlorin-*e*. This is a tricarboxylic acid (*e.g.*, it forms a trimethyl ester), and its molecular formula may thus be written as  $C_{31}H_{33}N_4(CO_2H)_3$ . Chlorin-*e*, on oxidation with chromic acid or with Caro's acid, gives hæmatinic acid, I, and ethylmethylmaleimide, II (Willstätter *et al.*, 1910). When chlorin-*e* is

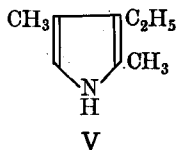
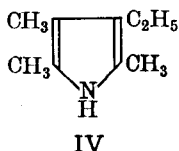
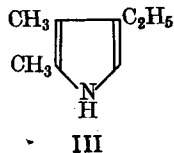
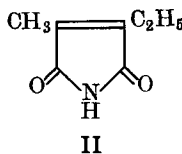
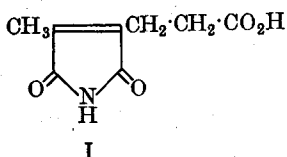

reduced with hydriodic acid in acetic acid, hæmopyrrole, III, and phyllopyrrole, IV, are produced (Willstätter *et al.*, 1911). When phylloporphyrin (see below) is reduced under the same conditions, the products are now III, IV, and cryptopyrrole, V. From these results it is reasonable to infer that chlorophyll-*a* contains four pyrrole nuclei, each probably having a methyl group in the  $\beta$ -position (see II-V). It is also reasonable to suppose that at least one pyrrole nucleus contains a propionic acid residue in the  $\beta'$ -position (see I). It also appears likely that a vinyl group is present in the molecule (this would account for the presence of an ethyl group on reduction; at the same time, the presence of an ethyl group, as such, is not excluded). Furthermore, the isolation of I and II on oxidation (giving oxidation at the  $\alpha$ -position), and of III and IV on reduction (the appearance of a methyl group at the  $\alpha$ -position), can be interpreted as meaning that the four pyrrole nuclei are joined to each other at their  $\alpha$ -positions *via* one carbon atom (*cf.* §2). Thus a possible skeleton structure for chlorin-*e* could be a cyclic one, VI; the positions of the various substituent groups cannot be assigned on the evidence obtained so far, *e.g.*, a methyl group at 1 and a propionic acid residue at 2 would produce the same oxidation product I had the positions

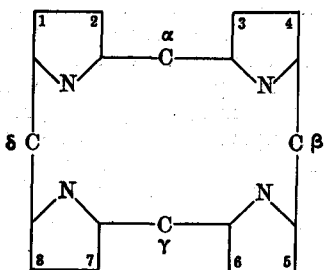

VI

of the two groups been interchanged in VI. It is also necessary to fit a second carboxyl group into this structure (VI), since chlorophyll-*a* forms chlorophyllide-*a* on hydrolysis (the latter compound contains two carboxyl groups). Furthermore, since chlorophyllide-*a*, on further hydrolysis, forms chlorin-*e*, a tricarboxylic acid, some group must be present which can give rise to this third carboxyl group. Such a group could be a lactone; it must be *cyclic* since no carbon atoms are lost after the hydrolysis.

By the further degradation of chlorin-*e*, e.g., heating in a sealed tube with ethanolic potassium hydroxide, various porphyrins are obtained. Three of these are pyrrporphyrin, rhodoporphyrin and phylloporphyrin.

Pyrrporphyrin,  $C_{30}H_{33}N_4 \cdot CO_2H$ , has an absorption spectrum closely resembling that of mesoporphyrin (see §2); this agrees with the tentative skeleton structure VI proposed for chlorin-*e*. Pyrrporphyrin, on bromination followed by oxidation with chromic acid, gives bromocitraconimide, VII, as one of the products (Treibs *et al.*, 1928). It therefore follows that at least one of the pyrrole nuclei in pyrrporphyrin has a free  $\beta$ -position available for bromination. Synthetic work then showed that pyrrporphyrin has structure VIII (H. Fischer *et al.*, 1929, 1930, 1933); thus the positions of the four methyl groups and the position of the propionic acid group are now established.

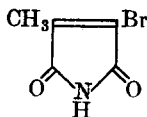

VII

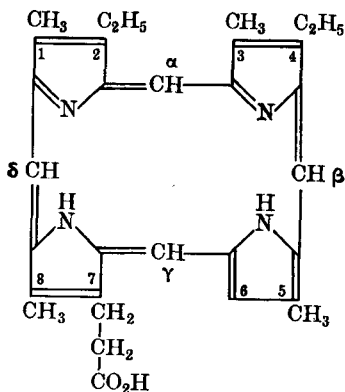

VIII

pyrrporphyrin

Rhodoporphyrin,  $C_{30}H_{32}N_4(CO_2H)_2$ , on heating with sodium ethoxide, readily loses *one* carboxyl group to form pyrrporphyrin (VIII). From a detailed study of the hæmin series, it was observed that a carboxyl group in a *side-chain* of a pyrrole nucleus was difficult to remove. Hence it is

probable that the carboxyl group lost from rhodoporphyrin is attached *directly* to a pyrrole nucleus. The only position for this carboxyl group is at 6 (see structure VIII); elimination of the carboxyl group from rhodoporphyrin would then give one pyrrole nucleus with a free  $\beta$ -position (6), *i.e.*, pyroporphyrin. Furthermore, comparison of the absorption spectra of rhodoporphyrin with compounds of known structure showed that the two carboxyl groups are in positions 6 and 7 (the latter is the propionic acid residue), and this was confirmed by the synthesis of rhodoporphyrin.

Phylloporphyrin,  $C_{31}H_{35}N_4 \cdot CO_2H$ , contains one  $CH_2$  group more than pyroporphyrin, and may be converted into the latter by heating with sodium ethoxide. It therefore follows that the alkyl groups in both compounds occupy similar positions. Synthetic work then showed that phylloporphyrin contains a methyl group attached to the  $\gamma$ -methyne carbon atom (H. Fischer *et al.*, 1930, 1933).

Consideration of the information obtained from the structures of the porphyrins described above shows that the skeleton structure IX is present in chlorin-*e*. Now chlorin-*e* contains three carboxyl groups and one more carbon atom than the structure shown in IX. The formation of a methyl

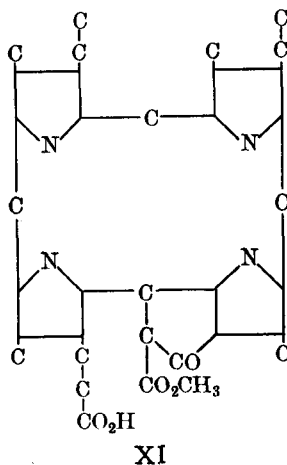
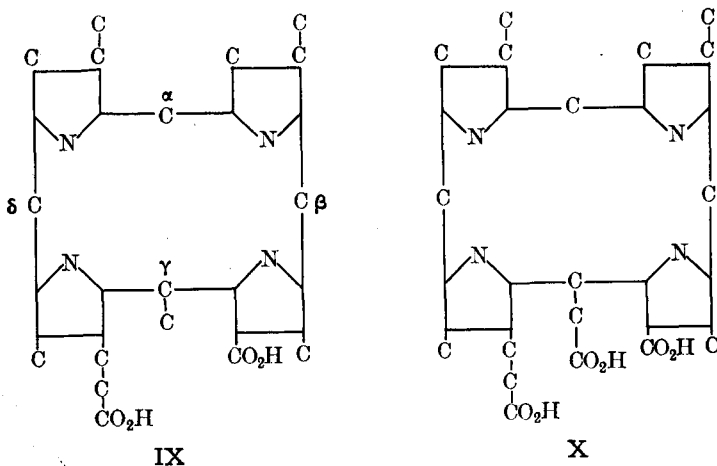

group (at the  $\gamma$  carbon atom) could be explained by assuming a carboxyl group is attached as shown in structure X.

When phytyl phæophorbide-*a* (III, §6) is hydrolysed with acid, the phytyl group is removed to form phæophorbide-*a*.

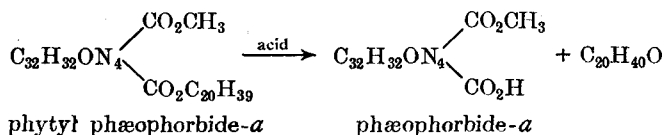

When phæophorbide-*a* is treated with hydriodic acid in acetic acid and followed by atmospheric oxidation, the product is phæophorphyrin-*a*<sub>5</sub>. This, on further treatment with hydriodic acid in acetic acid, forms phylloerythrin,  $\text{C}_{33}\text{H}_{34}\text{O}_3\text{N}_4$ , by loss of the carbomethoxyl group; phylloerythrin has the same absorption spectrum as that of the porphyrins, and so the porphin structure is still present. Now both phæophorbide-*a* and phylloerythrin contain a keto group (as is shown by the formation of an oxime, etc.), and so when the carbomethoxyl group is hydrolysed, the elimination of carbon dioxide can be expected if the keto group is in the  $\beta$ -position with respect to the carboxyl group (produced on hydrolysis). Furthermore, the hydrolysis of phæophorbide-*a* with methanolic potassium hydroxide gives chlorin-*e*. In this reaction, apart from the hydrolysis of the carbomethoxyl group, the keto group is lost and a carboxyl group is introduced *without the loss of any carbon atoms*. This may be explained by assuming that this carboxyl group (the third one in chlorin-*e*) is produced by the fission of a *cyclic ketone*, and not from a lactone as suggested previously (see above). Thus a possible skeleton structure for phæophorbide-*a* is XI; if the ketone ring is opened, then the formation of X can be expected. Also, the hydrolysis of XI would produce a  $\beta$ -keto-acid, which can be expected to lose carbon dioxide readily to form phylloerythrin.

Phæophorbide-*a* can be reduced catalytically to its dihydro-derivative in which the keto group remains intact. This suggests the presence of a readily reducible double bond. Oxidation experiments on phæophorbide-*a* and dihydrophæophorbide-*a* showed the presence of one vinyl group in the

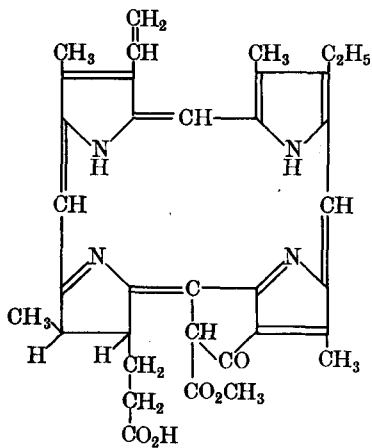

XII

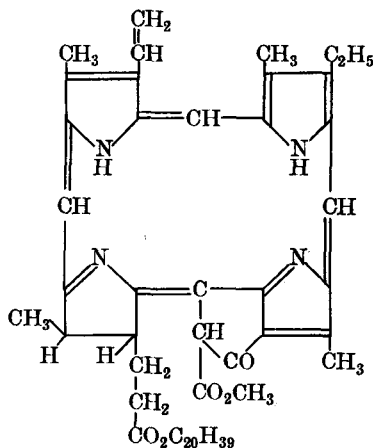
phæophorbide-*a*

XIII

phytyl phæophorbide-*a*

former. Furthermore, the existence of a vinyl group in the ester of chlorin-*e* was shown by the reaction with diazoacetic ester to give a cyclopropane derivative, which was isolated by the oxidation of the addition product (H. Fischer *et al.*, 1935; *cf.* §2a. XII). Thus one of the ethyl groups (see pyroporphyrin, VIII) must have been a vinyl group before reduction. Further degradative and synthetic work by H. Fischer *et al.* (1934–1936) showed that phæophorbide-*a* is XII and that phytol phæophorbide-*a* is XIII.

The replacement of the two imino hydrogen atoms in XIII by a magnesium atom would therefore give chlorophyll-*a*; this is XIV. Chlorophyll-*b* has been assigned structure XV.

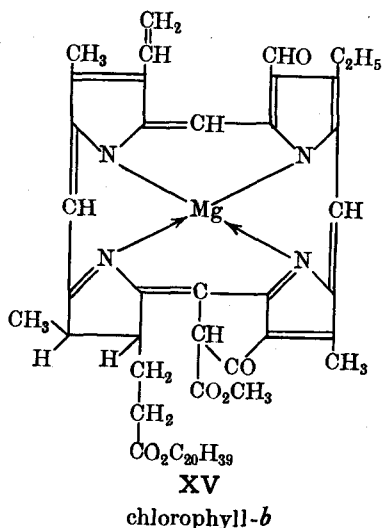
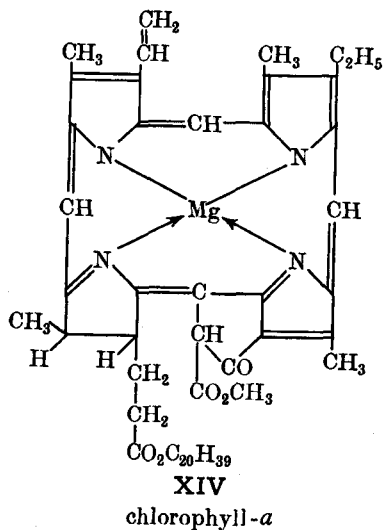

The total synthesis of chlorophyll-*a* has now been carried out by Woodward *et al.* (1960) and by Strell *et al.* (1960). Chlorin-*e*<sub>6</sub> trimethyl ester was synthesised, and since this had already been converted into chlorophyll-*a*, this constitutes a total synthesis.

A new chlorophyll, chlorobium chlorophyll, has been isolated from the culture *Chlorobium thiosulphatofilium* (Holt *et al.*, 1960).

**Biosynthesis of chlorophyll.** Although the steps are not clearly defined, Granick (1948, 1961) has produced evidence to show that chlorophyll is synthesised by green plants from protoporphyrin (*cf.* §4a).

## PHTHALOCYANINES

**§8. Preparation of the phthalocyanines.** Phthalocyanines are a very important class of organic dyes and pigments; they are coloured blue to green. They were discovered by accident at the works of Scottish Dyes Ltd. in 1928. It was there observed that some lots of phthalimide, manufactured by the action of ammonia on molten phthalic anhydride in an iron vessel, were contaminated with a blue pigment. The structure and method of formation of this compound were established by Linstead and his co-workers (1934).

The phthalocyanines form metallic complexes with many metals, and the colour depends on the nature of the metal (copper, magnesium, lead, etc.); greener shades are obtained by direct chlorination or bromination. The



metal phthalocyanines are insoluble in water, and are used as pigments. They are made water-soluble by sulphonation, and these soluble salts are used as dyes.

Metal phthalocyanines may be prepared as follows:

(i) By passing ammonia into molten phthalic anhydride or phthalimide in the presence of a metal salt.

(ii) By heating *o*-cyanobenzamides or phthalonitriles with metals or metallic salts.

(iii) By heating phthalic anhydride or phthalimide with urea and a metallic salt, preferably in the presence of a catalyst such as boric acid.

Phthalocyanine, I, the parent substance of this group, may be prepared by heating phthalonitrile with a little triethanolamine. It can be seen from formula I that phthalocyanine contains four isoindole nuclei joined in a ring by means of nitrogen atoms. If we ignore the benzene nuclei, then we have four pyrrole nuclei linked by nitrogen atoms, a structure similar

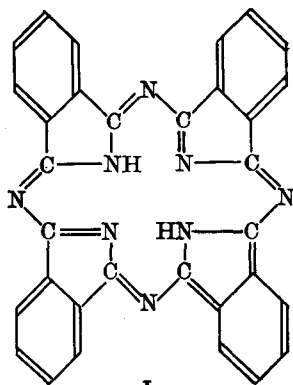

I  
phthalocyanine

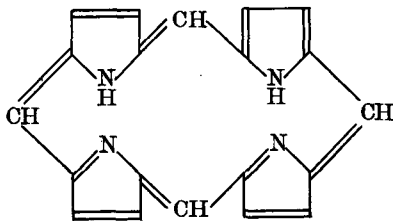

II  
porphin

to the porphyrins, in which the pyrrole nuclei are linked by methyne groups (II is porphin; *cf.* §2). Both types of compounds are coloured, and both contain two imino hydrogen atoms which can be replaced to form metal complexes. Because of these similarities the phthalocyanines are often known as the tetra-azaporphyrins. The first commercial phthalocyanine pigment was **Monastral Fast Blue BS**; this is copper phthalocyanine (III).

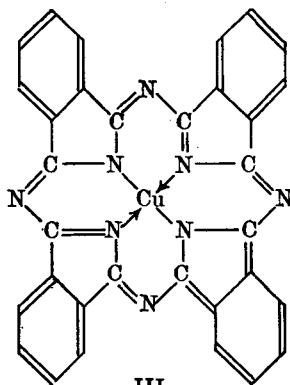

III  
Monastral Fast Blue BS

§9. **Structure of the phthalocyanines.** Analysis showed that the phthalocyanines had an empirical formula  $C_{32}H_{16}N_8M$ , where M is a bivalent metal, *e.g.*, copper, magnesium, etc. The molecular weight determination of magnesium phthalocyanine by the ebullioscopic method with naphthalene as solvent showed that the empirical formula was also the molecular formula (Linstead *et al.*, 1934). This has been confirmed by means of X-ray measurements (Robertson, Linstead *et al.*, 1935).

Linstead showed that the phthalocyanines can be obtained by reaction between a metal and phthalonitrile, I, *o*-cyanobenzamide, II, phthalamide, III, but *not* with, for example, terephthalonitrile, IV, homophthalonitrile, V, or *o*-xylylene dicyanide, VI. It is therefore reasonable to infer that in the

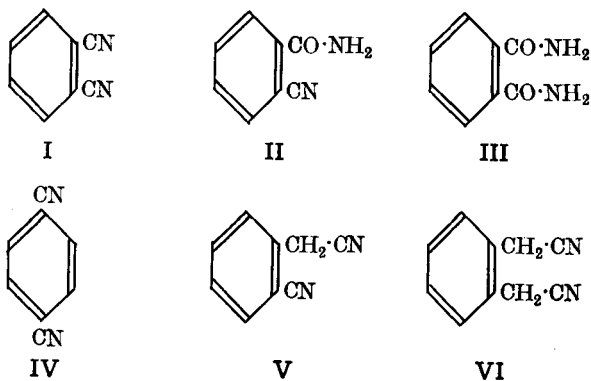

formation of phthalocyanines, the two nitrile groups involved must be in the *ortho*-position. Thus there are probably four  $C_8H_4N_2$  units, each having an *isoindole* structure, VII, or a phthalazine structure, VIII. VIII was

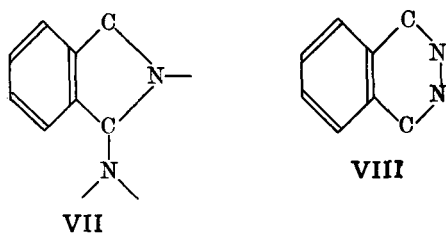

shown to be untenable since no phthalocyanine could be prepared from compounds containing this skeleton.

The oxidation of phthalocyanines with hot nitric acid, cold acid permanganate or ceric sulphate produces phthalamide and ammonium salts, the amount of phthalamide being that which would correspond to the presence of four *isoindole* units. The problem then is: How are these units joined together? The treatment of magnesium phthalocyanine with sulphuric acid replaces the magnesium atom by two hydrogen atoms.

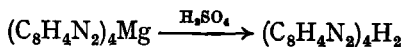

This suggests that in metal phthalocyanines, the metal has replaced two *imino* hydrogen atoms. A reasonable structure for phthalocyanine is one in which the four *isoindole* units are joined through nitrogen atoms to form

a cyclic structure (IX). On the other hand, an open-chain structure could also be produced by joining four *isoindole* units through nitrogen atoms (X);

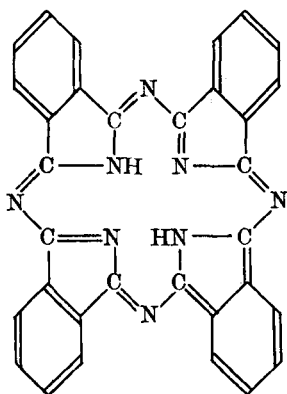

IX

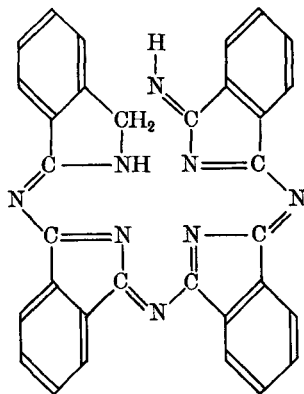

X

in this case the molecular formula would be  $(C_8H_4N_2)_4H_4$ . It seems unlikely that X could be rejected on these grounds alone, since in a large molecule of this type it appears to be difficult to estimate the hydrogen with certainty (IX contains approximately 3.5 per cent. hydrogen, and X 3.9 per cent.). X, however, is unlikely, since phthalocyanine is a very stable substance; the presence of an imino group at the end of the molecule could be expected to render the compound unstable to, *e.g.*, acid reagents. Furthermore, the oxidation of phthalocyanine with ceric sulphate in dilute sulphuric acid proceeds according to the following equation (over 90 per cent. of the phthalimide has been isolated).

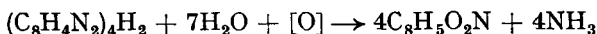

This agrees with IX, but had the structure been X, then the molecule would have required *two* atoms of oxygen.

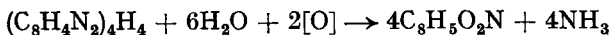

Thus IX represents best the known properties of phthalocyanine. The two imino hydrogen atoms are replaceable by a bivalent metal, and the remaining two nitrogen atoms form co-ordinate links (see formula III, §8).

In metal phthalocyanines resonance is possible, and so all four nitrogen atoms linked to the metal atom would be equivalent. Phthalocyanines (with and without a central metal atom) have been examined by means of X-ray analysis (Robertson, 1936), and the results show that these compounds are large *flat* molecules with a centre of symmetry. The bond lengths of the C—N bonds indicate resonance, as do those of the benzene ring (all the lengths are equal). Robertson also showed that for nickel phthalocyanine, if the radius of the nickel atom be assumed, then the positions of the other atoms in the molecule are exactly those obtained by chemical evidence.

#### READING REFERENCES

- Stewart and Graham, *Recent Advances in Organic Chemistry*, Longmans, Green. Vol. III (1948, 7th ed.). (i) Ch. 5. Some Natural Porphyrins and Related Compounds. (ii) Ch. 6. The Azaporphyrins.

## Phthalocyanines.

- (i) Linstead *et al.*, *J.C.S.*, 1934, 1016; 1936, 1745.
  - (ii) Robertson, *J.C.S.*, 1935, 615; 1936, 1195; 1937, 219; 1940, 36.
  - (iii) Dahlen, *Ind. Eng. Chem.*, 1939, 31, 839.
- Elderfield (Ed.), *Heterocyclic Compounds*, Wiley. Vol. I (1950). Ch. 6. Chemistry of Pyrrole and its Derivatives.
- Fischer and Orth, *Die Chemie des Pyrrols*, Leipzig. Vol. II (Part I, 1937; Part II, 1940).
- Gilman (Ed.), *Advanced Organic Chemistry*, Wiley (1943, 2nd ed.). (i) Ch. 16. The Chemistry of the Porphyrins. (ii) Ch. 17. Chlorophyll.
- Lemberg and Legge, *Hæmatin Compounds and Bile Pigments*, Interscience Publishers (1949).
- Rodd (Ed.), *Chemistry of Carbon Compounds*, Elsevier. Vol. IVB (1959). Ch. XIII. The Pyrrole Pigments.
- Bentley, *The Natural Pigments*, Interscience (1960).
- Maitland, Biogenetic Origin of the Pyrrole Pigments, *Quart. Reviews (Chem. Soc.)*, 1950, 4, 45.
- Popják, Chemistry, Biochemistry, and Isotopic Techniques, Lectures, Monographs and Reports of the Royal Institute of Chemistry, 1955, No. 2.
- Neuberger *et al.*, Biosynthesis of Porphyrins and Chlorophylls, *Nature*, 1961, 192, 204.
- Linstead, Discoveries among Conjugated Macrocyclic Compounds, *J.C.S.*, 1953, 2873.
- Willstätter and Stoll, *Investigations on Chlorophyll*, Science Press (1928).
- Livingston, Physicochemical Aspects of Some Recent Work on Photosynthesis, *Quart. Reviews (Chem. Soc.)*, 1960, 14, 174.
- Arnon *et al.*, Photoproduction of Hydrogen, Photofixation of Nitrogen and a Unified Concept of Photosynthesis, *Nature*, 1961, 192, 601.

## INDEX OF AUTHORS

Names associated with reactions, syntheses, etc., are not listed here ; they are described in the Subject Index.

### A

Aaron, 162  
Abderhalden, 473  
Adams, A., 433  
Adams, R., 129, 131, 132, 137  
Adler, 588  
Akabori, 475  
Albertson, 53, 451  
Alder, 259, 288  
Aldrich, 493  
Aldridge, 588  
Alexander, 24  
Allinger, 110, 113, 124  
Almquist, 624  
Altman, 654  
Ambrose, 469  
Amos, 588  
Andersag, 602  
Anderson, 472, 595  
Andriani, 49  
Anet, 496, 542  
Angell, 589  
Angier, 610, 611  
Angyal, 111  
Anner, 400  
Arago, 21  
Archer, 516  
Arens, 249  
Armstrong, 184  
Arshid, 8  
Arth, 268  
Asai, 476  
Aschan, 279  
Aston, 109  
Attenberg, 266  
Attenburrow, 334  
Austin, 75  
Auwers, von, 93, 94, 380  
Averill, 231

### B

Babo, 503  
Bachmann, 349, 400, 405  
Backer, 141  
Badger, 148  
Baeyer, von, 266, 272, 273, 275, 571, 573  
Bahadur, 482  
Bailey, 54, 349  
Bain, 151, 160  
Baker, 55, 435, 436  
Balbiano, 421  
Bamberger, 156  
Banholzer, 492  
Barber, 127  
Barbier, 248  
Barger, 492  
Barker, E. F., 148, 594  
Barker, G. R., 198, 202  
Barnard, 250  
Bartlett, 46, 65, 77, 290  
Barton, 122, 378, 381  
Bastiansen, 139  
Batchelor, 637  
Bateman, 250  
Battersby, 541  
Bauer, 565  
Baxter, 330  
Beckett, 55, 515  
Beckmann, 149  
Bednarczyk, 182  
Beets, 502  
Beevers, 216  
Behrend, 570, 573, 575  
Bell, E. V., 129, 171, 172  
Bell, F., 127, 130  
Ben-Ishai, 472  
Benkeser, 96  
Bennett, 147, 171, 172  
Bentley, 637  
Bergkvist, 78  
Bergmann, E. D., 172, 471, 473, 501  
Bergmann, F., 577  
Bernal, 360, 361, 376, 398  
Bernhauer, 619  
Bernstein, 27, 107  
Beyerman, 473  
Bide, 536  
Bijvoet, 32  
Binkley, 624, 626  
Biot, 8  
Birch, 271  
Birkinshaw, 639  
Bischoff, 145  
Bishop, C. T., 188  
Bishop, G., 152  
Black, 270  
Blicke, 510  
Bloch, 389, 390, 654  
Blomquist, 132  
Blout, 469  
Bösesken, 141, 185  
Boissonas, 474  
Booker, 245  
Bornwater, 571  
Bose, 515  
Bothner-By, 82  
Bouveault, 248, 254  
Bradley, 54  
Brady, 150, 152  
Braithwaite, 322  
Braude, 386  
Braun, 85  
Braun, von, 487  
Bredereck, 428, 584  
Bredt, 279, 281  
Brenner, 470  
Bretschneider, 508  
Briggs, 303  
Brigl, 216

Brink, 638  
 Brockman, 387  
 Brockway, 139  
 Brodskii, 157, 158  
 Broome, 361  
 Brown, H. C., 65, 560, 593  
 Brown, R. D., 423  
 Browning, 133  
 Brownstein, 135  
 Bruce, 372  
 Bryan, 138  
 Buchanan, C., 54, 131  
 Buchanan, J. M., 586  
 Bucher, 310  
 Buchner, 287  
 Buchta, 337, 353  
 Bunn, 318  
 Bunton, 73, 202, 203  
 Burns, 214  
 Burrows, 164  
 Burwell, 48  
 Buser, 387  
 Butenandt, 368, 372, 395, 396, 398, 409,  
 410, 411, 413  
 Buu-Hoi, 350

## C

Cahn, 35  
 Calvin, 232, 650, 657  
 Campbell, I. G. M., 163, 166, 169  
 Campbell, W. P., 301, 303  
 Cantor, 182  
 Carter 593, 638  
 Casanova, 55  
 Cavalieri, 575  
 Caventou, 656  
 Celmer, 140  
 Challenger, 174  
 Chapman, 157  
 Chargaff, 595  
 Chatt, 165, 167  
 Chatterjee, 490  
 Chavanne, 100  
 Christie, 126  
 Clar, 348, 349  
 Claridge, 637  
 Clarke, 599  
 Cleeton, 148  
 Clemo, 24, 551  
 Close, 438  
 Clusius, 575  
 Cohen, 167  
 Cohn, 592, 593, 596  
 Cole, 268  
 Cook, 349, 350, 367, 398, 399, 400, 404,  
 405  
 Cornforth, 378, 389, 390  
 Corwin, 648  
 Cotton 85  
 Coulson, 11, 26, 134  
 Cox, 198  
 Crabbé, 390  
 Craig, 509  
 Cram, 84, 102, 132, 142  
 Crawford, 130  
 Cresswell, 608  
 Cristol, 100, 103, 116  
 Crowfoot, D. C., 386, 408, 409

Crowley, 278  
 Curtin, 94

## D

Dakin, 444, 457, 460, 493  
 Dalghiesh, 494, 495  
 Dam, 623  
 Dane, 358, 360  
 Darmon, 468  
 Dauben, H. J., (Jun.), 61  
 Dauben, W. G., 372, 405  
 Davies, 162  
 Davis, B. D., 481  
 Davis, E. F., 592  
 Davis, T. L., 85  
 Dawson, 543  
 Debye, 2, 11  
 Delahay, 182  
 Dewar, 422  
 Dhar, 139  
 Diels, 245, 288, 309, 345, 358  
 Dimroth, 383  
 Djerassi, 379  
 Dodds, 408  
 Doering, 47, 65, 530  
 Doisy, 398, 404, 623  
 Domagk, 627  
 Drew, 192  
 Drumm, 423  
 Dubrunfaut, 181  
 Dufraisie, 348  
 Dunitz, 641  
 Dunlop, 145  
 Dunn, 588  
 Dvoretzky, 425

## E

Eaborn, 174  
 Earl, 434, 435, 436  
 Eascott, 612  
 Easty, 54  
 Edman, 475  
 Ehrlich, G., 470  
 Ehrlich, P., 627, 631  
 Eijkman, 598  
 Eiland, 198  
 Einhorn, 519  
 Eisenlohr, 79, 119  
 Ekenstein, 184  
 Eiel, 24, 122, 268  
 Elisberg, 398  
 Elliott, A., 469  
 Elliott, K. A. C., 54, 130  
 Elming, 514  
 Elving, 124  
 Emden, 593  
 Erlenmeyer, 24  
 Eschenmoser, 299  
 Ettinger, 240  
 Evans, 235  
 Everest, 552

## F

Falk, 655  
 Faraday, 10  
 Faulkner, 182  
 Fear, 187  
 Ferguson, 135

- Fernholz, 382, 388, 620, 621, 626  
 Ferreira, 55, 85  
 Fieser, 347, 350, 367, 387, 392, 624  
 Finar, 423, 425, 426, 427, 455  
 Findlay, 519  
 Fischer, E., 25, 30, 31, 32, 69, 96, 178, 184,  
 187, 190, 234, 235, 442, 443, 457, 468,  
 471, 473, 567, 569, 572, 573, 574, 575,  
 576, 577, 578, 579, 580, 581, 583, 584  
 Fischer, F., 308  
 Fischer, H., 646, 647, 648, 649, 651, 659,  
 660, 662  
 Fisher, 258  
 Fittig, 572  
 Flavitzky, 275  
 Fleming, 632  
 Fleury, 216  
 Fodor, 515, 517, 519  
 Folkers, 617, 618, 638  
 Fonken, 360  
 Powden, 427  
 Frankel, 471  
 Fraser, 469  
 Fredga, 50  
 Fresnel, 56, 57  
 Freudenberg, 9, 490  
 Friedmann, 493  
 Frölich, 209  
 Fulmer, 612  
 Funk, 598  
 Furberg, 589, 592
- G
- Gabriel, 440, 444  
 Gadamer, 240  
 Gafner, 135  
 Galat, 460  
 Gallagher, 366  
 Gams, 536  
 Gates, 541  
 Geissman, 545  
 Gierer, 595  
 Gillam, 298  
 Girard, 405, 407  
 Glynn, 147  
 Gold, 62  
 Goldschmidt, 149, 156  
 Goldschmiedt, 533  
 Goodwin, 608  
 Goto, 182  
 Graebe, 6  
 Granick, 662  
 Green, 162  
 Greenberg, 586  
 Grewe, 602  
 Grignard, 250  
 Grijns, 598  
 Grimaux, 438, 537, 572  
 Grisebach, 566  
 Gross, 458  
 Guha, 277  
 Guiteras, 388  
 Gulland, 540, 590, 595  
 Gurnani, 449
- H
- Haller, 283  
 Hammett, 69  
 Hanby, 145
- Hantzsch, 149, 152, 153, 497  
 Harada, 52  
 Hardegger, 520  
 Harington, 462, 464  
 Harley-Mason, 161, 316  
 Harper, 358  
 Harries, 250, 254, 287, 295, 296, 317  
 Harris, G. S., 169  
 Harris, R. J., 593  
 Harris, S. A., 614, 617  
 Hartley, 160  
 Hartung, 455  
 Harvey, 164  
 Hass, 54  
 Hassel, 109, 111, 117, 120, 135, 201  
 Hatt, 162  
 Havinga, 385  
 Hawkins, 208  
 Haworth, R. D., 310, 312, 402  
 Haworth, W. N., 29, 187, 189, 190, 191,  
 192, 193, 195, 196, 197, 209, 212, 214,  
 220, 227, 229, 230, 231, 237  
 Hayes, 587  
 Hazato, 354  
 Head, 228  
 Heard, 158  
 Heggie, 85  
 Heilbron, 330, 384, 385, 389  
 Helfer, 120  
 Helferich, 236  
 Hems, 464  
 Henderson, 54  
 Henecka, 270  
 Henriques, 136, 149  
 Heppel, 594  
 Herzig, 564  
 Hess, 496  
 Hesse, 537  
 Hibbert, 227  
 Higuchi, 482  
 Hill, 156, 159, 183  
 Hinshelwood, 66  
 Hirs, 469  
 Hirst, 188, 209, 210, 212, 228, 230  
 Hodgkin, D. C., *see* Crowfoot, D. C.  
 Hofmann, 501  
 Hofmeister, 468  
 Holliman, 163, 164, 165, 170  
 Holst, 209  
 Holt, 662  
 Hopper, 159  
 Horning, 153, 156  
 Horowitz, 214  
 Hosoya, 172  
 Hough, 201  
 Hsü, 47  
 Huber, 504  
 Hückel, 47, 118, 120  
 Hudson, 52, 185, 186, 198, 199  
 Huffman, 402  
 Hughes, E. D., 24, 47, 61, 62, 64, 65, 66,  
 67, 68, 69, 71, 72, 73, 74, 75, 103  
 Hughes, G. A., 401  
 Hunter, 3  
 Hurd, 200
- I
- Iffland, 129  
 Ingold, 24, 35, 47, 48, 60, 61, 62, 66, 67,  
 68, 69, 71, 72, 73, 74, 75, 103, 242, 243

Ingram, 133  
 Inhoffen, 326, 385  
 Irvine, 225, 239, 240  
 Isbell, 203  
 Isensee, 449  
 Isler, 325, 326, 331, 337  
 Ives, 24

## J

Jackman, 81  
 Jahns, 499  
 Jamison, 53, 55  
 Jansen, 141  
 Jensen, 112  
 John, 619, 621, 622  
 Johnson, 110, 112, 117, 343, 401, 405  
 Jones, A. S., 596  
 Jones, E. R., 249, 335, 382  
 Jones, E. T., 236  
 Jones, H. O. N., 145  
 Jones, J. K. N., 227  
 Jones, R. G., 422  
 de Jong, 107  
 Joshi, 7  
 Jowett, 493

## K

Kaczkowski, 543  
 Kamai, 164  
 Karabatsos, 160  
 Karagounis, 65  
 Kargl, 330  
 Karrer, 171, 172, 309, 313, 322, 323, 324,  
 327, 328, 329, 330, 337, 508, 547, 605,  
 606, 621, 623  
 Kaufler, 126  
 Keesom, 2, 5  
 Kegel, 623  
 Keilin, 643  
 Kekulé, 22  
 Kelham, 131  
 Kendall, 415, 462  
 Kenner, 126  
 Kenyon, 52, 70, 71, 79, 127, 157, 173  
 Kerr, 276  
 Kerschbaum, 296  
 Kharasch, 409  
 Kimball, 76, 98, 168  
 Kincaid, 136, 149  
 King, H., 358, 360  
 King, H. G. C., 565  
 Kipping, 147, 162, 173, 174  
 Kistiakowsky, 104  
 Kleinert, 226  
 Klement, 167  
 Klotz, 273  
 Knights, 253  
 Knopf, 85  
 Knorr, 235, 422, 423, 424, 426, 538, 643  
 Koepli, 419  
 Kögl, 418, 419, 612, 613  
 Kohler, 140, 154  
 Komppa, 282, 283, 286, 287  
 Kon, 270, 358, 363  
 Königs, 235, 484, 523, 524  
 Kopp, 4, 5  
 Kornberg, 596  
 Kornblum, 129

Kostanecki, 559, 561, 563  
 Kötz, 269  
 Kraemer, 228  
 Kraft, 312  
 Krause, 159  
 Krebs, 480  
 Krüger, 251  
 Kuehl, 638  
 Kuhara, 157  
 Kuhn, L. P., 15  
 Kuhn, R., 321, 323, 324, 328, 329, 336,  
 603, 604, 605, 615  
 Kuhn, W., 53, 85, 91  
 Kumpf, 474  
 Küster, 646  
 Kwart, 285

## L

Ladenburg, 484, 501, 504, 510, 511  
 Laiblin, 506  
 Lander, 140  
 Lapworth, 140  
 Laqueur, 396  
 Le Bel, 21, 144  
 Lee, 484  
 Leeds, 403  
 Leete, 542, 543  
 Le Fèvre, 109, 126, 127, 161, 436  
 Lemieux, 216, 217  
 Leslie, 128, 166  
 Leuchs, 54  
 Levene, 589, 590, 592, 594, 595  
 Levy, 24  
 Lewinsohn, 174  
 Lewis, 516  
 Lichtenstadt, 150  
 Liddle, 442, 443  
 Liebermann, 336  
 Liebig, 569, 570  
 Lindlar, 332  
 Lindsay, 354  
 Linstead, 117, 658, 662, 664  
 Lipp, 288  
 Littlefield, 588, 589  
 Löfgren, 576  
 Lohmann, 603  
 Londergan, 600  
 London, 2  
 Long, 641  
 Lorentz, 7  
 Lorenz, 7  
 Loring, 593  
 Lowry, 175, 182, 183  
 Lucas, 76  
 Lukeš, 496  
 Lüttringhaus, 132  
 Lynen, 315, 316  
 Lythgoe, 591

## M

McArthur, 619  
 Macbeth, 113, 238  
 McCasland, 39, 146  
 McDonald, 198  
 McElvain, 500  
 McEwen, 162  
 McFadden, 233  
 McGilvray, 228



McKee, 623, 624, 625, 626  
 McKenzie, 55, 81  
 Mackenzie, 510  
 Macleod, 6  
 McNutt, 607  
 McQuillin, 306  
 Magat, 64  
 Maitland, 139  
 Malaguti, 279  
 Malaprade, 198  
 Mamoli, 397  
 Manasse, 268  
 Mann, 163, 164, 165, 167, 168, 170, 175  
 Mannich, 543  
 Manske, 490  
 Manson, 592  
 Marckwald, 55, 79  
 Marion, 543  
 Markakis, 552  
 Marker, 405, 412  
 Marrian, 401, 414  
 Marsh, 285  
 Martin, 457  
 Matthiessen, 537  
 Medicus, 572  
 Meerwein, 288  
 Meier, 79  
 Meisenheimer, 138, 147, 148, 153, 154,  
 155, 162  
 Meldrum, 258  
 Menschick, 362  
 Merling, 511  
 Mester, 190, 201  
 Meyer, K. H., 228, 229, 231  
 Meyer, V., 149  
 Michael, 98, 100  
 Michalski, 162  
 Michler, 126  
 Miescher, 366, 400  
 Miller, 109, 482, 612  
 Mills, J. A., 111, 123, 378  
 Mills, W. H., 53, 54, 128, 130, 131, 139,  
 141, 145, 151, 160, 164  
 Mingoia, 491  
 Mirza, 515  
 Mislow, 50, 129, 130  
 Mitchell, 85  
 Mizushima, 28  
 Modi, 322  
 Mohr, 116  
 Momber, 31  
 Montgomery, 230  
 Morton, 335  
 Mosher, 82  
 Motl, 303  
 Moureu, 424  
 Mulder, 465  
 Mumford, 6  
 Musher, 94, 120

## N

Nagai, 494  
 Nakamiya, 322  
 Neagi, 145  
 Nerdel, 53  
 Neuburger, 654  
 Nevell, 290  
 Newman, 26, 134, 356  
 Nicolaidis, 314

Nodder, 141  
 Noller, 362  
 Normant, 254  
 Norymberski, 398

## O

Oeda, 52  
 Ogawa, 52  
 Oliver, 250  
 Olivier, 68  
 Oppenauer, 397  
 Orgel, 423  
 Oró, 482  
 Oroshnik, 334  
 Ostwald, 1  
 Ott, 493  
 Otvös, 284  
 Overend, 183

## P

Parikh, 458  
 Park, 316  
 Pascu, 182  
 Pasteur, 22, 51, 52  
 Paterno, 22  
 Pauling, 29, 469  
 Peachey, 144, 169, 174  
 Peat, 207, 229  
 Pechmann, von, 421  
 Peck, 638  
 Pelletier, 656  
 Peppiatt, 380  
 Perkin (Jun.), 258, 267, 273, 282  
 Perkin (Sen.), 449  
 Perlmutter-Hayman, 203  
 Petuely, 212  
 Phillips, D. D., 352  
 Phillips, H., 6, 170, 173  
 Phillips, W. D., 160  
 Pickard, 52  
 Pictet, 208, 221, 536  
 Piloty, 648, 649  
 Pinner, 506  
 Pitzer, 26, 28, 109, 110  
 Plattner, 307  
 Plaut, 607, 608  
 Pocker, 24  
 Polanyi, 47, 72  
 Pope, 140, 141, 144, 164, 169, 174  
 Posternak, 619  
 Powell, 55  
 Prelog, 35, 82, 149, 378  
 Prevost, 62  
 Price, 123  
 Pringsheim, 221  
 Proskow, 39, 146  
 Pschorr, 539  
 Pummerer, 317  
 Purdie, 187

## Q

Quilico, 244

## R

Rabe, 526, 527, 529, 530  
 Radziszewsky, 428  
 Rainbow, 612  
 Rao, 277

- Raper, 164  
 Rapoport, 544  
 Rappoldt, 385  
 Read, 268  
 Rebstock, 640, 641  
 Reeves, 201, 202  
 Reichstein, 415, 417  
 Reid, 81  
 Richter, 579  
 Ried, 135  
 Riniker, 378  
 Roberts, 76, 98, 149  
 Robertson, A., 236  
 Robertson, G. B., 162  
 Robertson, J. M., 135, 354, 664, 665  
 Robeson, 334  
 Robinson, 371, 389, 400, 513, 514, 540,  
 541, 545, 548, 549, 551, 552, 554,  
 555, 556, 557, 563  
 Roeder, 442, 443  
 Rolinson, 637  
 Roosen, 573  
 Roozeboom, 49  
 Rosanoff, 31  
 Rosenheim, A., 168  
 Rosenheim, O., 358, 360  
 Rosenthaler, 84  
 Ross, 24, 79, 80  
 Rossini, 117  
 Roth, 323  
 Rothmund, 650  
 Rüber, 185  
 Rudney, 315, 316  
 Rule, 54  
 Rupe, 265  
 Ruzicka, 245, 252, 254, 277, 294, 296,  
 297, 298, 300, 301, 303, 304, 305,  
 307, 309, 312, 313, 372, 380, 389,  
 395, 397  
 Rydon, 145, 312
- S**
- Sachse, 109, 116  
 Salway, 147  
 Sandberg, 258  
 Sandermann, 312  
 Sanger, 459, 476  
 Sarasin, 577  
 Sarett, 417  
 Sauers, 284  
 Schaeffer, 442  
 Scheele, 569  
 Schenk, 638  
 Scheuer, 322  
 Scheurer, 235  
 Schiessler, 314  
 Schimmel, 270  
 Schlack, 474  
 Schlenk, 55  
 Schmid, 172  
 Schmidt, E., 226  
 Schmidt, G. M. J., 134  
 Schmidt, J., 126  
 Schmidt, O. T., 130  
 Schoch, 229  
 Schofield, 445  
 Scholl, 354  
 Schöpf, 314, 514, 544  
 Schreiber, 382  
 Schuetz, 380  
 Schultz, 126  
 Schulz, 228, 318  
 Schwarz, A., 269  
 Schwarz, R., 174  
 Schwyzer, 474  
 Seekles, 524  
 Sela, 469  
 Semmler, 245, 248, 260, 261, 269, 293,  
 298, 301, 303  
 Semper, 150  
 Sertürner, 484, 537  
 Shearer, 172  
 Sheehan, 472  
 Shemin, 654, 655  
 Shepherd, 414  
 Sherndal, 307  
 Shildneck, 132  
 Shoppee, 378, 380  
 Sidgwick, 11  
 Simonis, 559  
 Simonsen, 257, 267, 276  
 Simpson, J. C. E., 435  
 Simpson, T. H., 558  
 Skita, 94, 380  
 Skraup, 523, 529  
 Smiles, 127, 170  
 Smith, F., 200  
 Smith, H. G., 270  
 Smith, L., 617  
 Smith, L. I., 621  
 Sneedon, 360  
 Snyder, 72, 497  
 Soffer, 301, 302, 303  
 Solomons, 140  
 Sondheimer, 396, 552  
 Sonne, 586  
 Sorm, 296  
 Sparke, 516  
 Späth, 490, 492, 498, 508, 521, 565  
 Spielman, 502  
 Srinivasan, 482  
 Stacey, 221  
 Staedel, 51  
 Stanley, R. G., 316  
 Stanley, W. M., 130  
 Staudinger, 228  
 Steenbock, 384  
 Steinberg, 482  
 Stephen, 158, 159  
 Stern, F., 58  
 Stern, M. H., 606, 623  
 Stevens, 472  
 Stiller, 608, 609  
 Stokes, 656  
 Stolz, 493  
 Streitwieser, 24  
 Strell, 662  
 Sugden, 6  
 Sutter, 142  
 Sutton, 7, 436  
 Swain, 183  
 Swart, 62  
 Symons, 60, 61  
 Szent-Giörgi, 209
- T**
- Takamine, 493  
 Tanret, 181

- Tavormina, 315, 389  
 Taylor, E. C., 499  
 Taylor, W. I., 303  
 Teichmann, 643  
 Theimer, 252  
 Thorpe, 273, 282  
 Tiemann, 247, 248, 251, 254, 260  
 Tipson, 570  
 Tishler, 333, 451  
 Tobie, 183  
 Todd, 441, 578, 589, 591, 592, 593, 594,  
 595, 596, 604, 618  
 Tollens, 181  
 Traub, 615  
 Traube, 574, 578, 580  
 Trebst, 233  
 Treibs, 659  
 Tschesche, 368  
 Tschugaeff, 10  
 Tuli, 7  
 Tulinsky, 135  
 Turner, E. E., 53, 55, 81, 126, 127, 128,  
 134, 164, 166  
 Turner, R. E., 110
- U
- Underhill, 566
- V
- van der Waals, 2, 3  
 van Dorp, 249, 333  
 van't Hoff, 9, 21, 26, 30, 87, 88, 139  
 Veldestra, 419  
 Velluz, 385, 404  
 Verley, 247  
 Verwoerd, 596  
 Vesterberg, 309, 345  
 Vignau, 454  
 du Vigneaud, 612, 613, 614  
 Vocke, 311  
 Vogel, 460  
 Vogt, 259  
 Vongerichten, 538, 539
- W
- Wackenroder, 321  
 Wagner, 257, 274, 286, 287, 288  
 Waksman, 637  
 Walden, 69  
 Wallach, 242, 256, 257, 265, 266, 269,  
 274, 293, 295  
 Walz, 565  
 Warren, 145  
 Watson, 595  
 Wechsler, 140  
 Weisblat, 472
- Wendler, 625  
 Werner, 95, 136, 145, 149, 152  
 Wessely, 566  
 West, 571  
 Westall, 655  
 Westheimer, 136  
 Weston, 169  
 Westphal, 372  
 Weygand, 472  
 Whalley, 99  
 Wheeler, H. L., 442, 443  
 Wheeler, T. S., 560, 562  
 Whiffen, 202  
 Whitfield, 596  
 Whitmore, 288  
 Whittaker, 441  
 Whitworth, 141  
 Wibaut, 502  
 Wiberg, 99  
 Wicker, 380  
 Wieland, 149, 358, 359, 360, 361, 367,  
 369  
 Wijkman, 142  
 Wildiers, 612  
 Wilkins, 595  
 Wilkinson, 536  
 Williams, R. J., 608, 610  
 Williams, R. R., 599, 600, 601, 602  
 Willstätter, 119, 308, 321, 495, 511, 518,  
 519, 545, 546, 548, 564, 656, 657,  
 658  
 Wilson, 319  
 Windaus, 359, 361, 383, 384, 385, 387,  
 391, 599  
 Winstein, 74, 76, 77, 78, 79, 98, 101, 122  
 Winterstein, 657  
 Wintersteiner, 404, 415  
 Wislicenus, 91, 96  
 Witnauer, 230  
 Wohl, 31, 499, 525  
 Wöhler, 569, 570  
 Wöhmann, 599  
 Wolf, 316  
 Wolff, 444  
 Wolfrom, 183, 230, 638  
 Wood, 510  
 Woods, 629  
 Woodward, 371, 389, 530, 541, 639, 640  
 Wrinch, 469, 470  
 Wyatt, 589
- Z
- Zemplen, 221  
 Zenitz, 515  
 Ziegler, 266  
 Zimmermann, 126

## INDEX OF SUBJECTS

Names beginning with the prefixes *cyclo* and *iso* are listed under C and I, respectively. Salts of acids are listed under the parent acid, acetates of sugars under the parent sugar, and essential oils under Oil. Many ethyl esters are listed as acid esters. Deuterio-compounds are listed under Deuterium compounds. Name reactions which have been used in the text are listed in this index. Page numbers printed in bold type are the more important references, and substituted derivatives have often been listed under the parent compound by numbers in italics; more important substituted derivatives have been listed separately.

### A

- $\alpha$ -Series (in Steroids), 378  
 Abietic acid, 309-313  
 Abietinol, 312  
 Absorption spectra, **13-16**, 25, 51, 61, 85, 94, 136, 148, 150, 166, 182, 211, 245, 298, 358, 405, 457, 478, 545, 592, 599, 613, 623, 625, 640, 646, 656, 659, 660, 661  
   **Infra-red**, **3**, **13-15**, 30, **94**, 114, 147, 148, 202, 245, 250, 268, 318, 468, 469, 470, 476, 515, 593, 635  
   **Raman**, 16, **94**, 245  
   **Ultraviolet and Visible**, **13-14**, **94**, 150, 161, 182, 245, 273, 312, 329, 362, 383, 384, 385, 398, 410, 443, 590, 599, 600, 601, 610, 615, 620, 621  
 Accelerators (rubber), 319  
 Acetamidine, 441, 601, 602, 603  
 Acetoacetic ester syntheses, 249, 257, 258, 297, 308, 424, 426, 427, 433, 441, 455, 496, 529, 573, 600, 630, 644  
 Acetobromohexoses, 208, 215, **234-235**, 239, 553  
 Acetochlororibofuranose, 592  
 Acetolysis, 225  
 2-Acetomethylamido-4':5-dimethyl-diphenyl sulphone, 54, 131  
 Acetone compounds, *see* Isopropylidene derivatives  
 Acetonedicarboxylic acid, 497, 514, 519  
 Acetophenone, 81, 430, 445, 446, 510, 548, 558, 559, 562, 641  
 Aceturic acid, 455, 473  
 Acetylacetone, 248, 645  
 9-Acetyl-*cis*-decalin oxime, 159  
 Acetylene, 249, 254, 297, 309, 320, 331, 405, 421, 433  
 Acetylenedicarboxylic acid, 96, 100, 299, 424  
 3-Acetyl-5:9-dimethyldecalin, 306  
*N*-Acetylglucosamine, 232  
 1-Acetyl-2-hydroxynaphthalene-3-carboxylic acid, 155  
 $\gamma$ -Acetyl- $\alpha$ -isopropylbutyric acid, 270  
*N*-Acetyl-*N*-methyl-*p*-toluidine-3-sulphonic acid, 131  
 Acetylthiohydantoin, 456  
 Acorone, 307  
 Acraldehyde, 425, 499  
 Acridines, 630  
 ACTH, 415  
 Activators (enzyme), 479  
 Addition to double bonds, stereochemistry of, 96-99, 363-364, 379-380  
 Additive properties, 1, 5, 6, 7, 9, 10  
 Adenine, 577-579, 588, 589, 593, 595  
 Adenosine, 589-592, 594  
 Adenylic acid, 589, 593  
 Adermin, *see* Pyridoxin  
 Adrenaline, 493-494  
 Adrenosterone, 415  
 $\beta$ -Etiobilanic acid, 366, 367, 371  
 $\beta$ -Etiocholanic acid, *see* Etianic acid  
 $\beta$ -Etiocholanone, 366  
 $\beta$ -Etiocholyl methyl ketone, 366  
 $\beta$ -Etioporphyrins, 646, 647, 650  
 Aglycon, 184, 234  
 Alanine, 449, 452, 455  
 $\beta$ -Alanine, 608, 609, 610, 612  
 Albumins, 466  
 Aldoses, 176-180, 181-184  
 Aldoximes, stereochemistry of, 149-153  
 Alginic acid, 232  
 Alizarin, 236  
 Alkaloids, 52, 55, **484-544**  
 Allantoin, 570-572  
 Allenes, stereochemistry of, 139-140  
*Allo*-series in amino-acids, 459  
   in steroids, 377  
*Allo*cholanolic acid, 360, 390, 391  
 Allomucic acid, 179  
 Allophanic acid, 438  
 Allose, 179-180  
*Allo*threonine, 459  
 Alloxan, 439, 440, 569-570, 579, 605, 607  
 Alloxantin, 570  
 Alloxazines, 448  
 Allylbenzylmethylphenylammonium iodide, 144  
 Allyl chloroformate, 472  
 Allylic rearrangement, 249, 253, 297, 308, 326, 332  
 Allyl isothiocyanate, 240  
 Alternating axis of symmetry, 38-39  
 Altrose, 179-180  
 Aluminium *t*-butoxide, *see* Oppenauer oxidation  
 Amidines, 441  
   *see also* Acetamidine and Formamidine  
 Amine oxides, stereochemistry of, 146-147  
 Amino-acids, 53, 449-465, 467  
*p*-Aminobenzoic acid, 610, 611, 619, 629  
 10-*m*-Aminobenzylideneanthrone, 133  
 4-Aminoimidazole-5-carboxamide, 428

- 6-Aminopenicillanic acid, 637  
*o*-Aminophenol, 431, 433, 466  
 1-Aminopropan-2-ol, 618  
 $\alpha$ -Amino- $\beta$ -1-pyrazolylpropionic acid, 427  
*o*-Aminothiophenol, 432  
 5-Aminouracil, 573  
 Amphetamine, *see* Benzedrine  
 Amphoteric electrolytes (ampholytes), 460, 545  
 Amygdalin, 237-238  
 Amylase, 228, 230, 231, 477, 479  
 Amylopectin, 230-231  
 $\alpha$ -Amylose, 229-230  
 $\beta$ -Amylose, *see* Amylopectin  
 Anaesthetics, 520  
 Anchimeric assistance, 74  
 Androgens, 395-398  
   *see also individuals*  
 Androstenedione, 398  
 Androsterone, 395-396  
 Aneurin, *see* Vitamin B<sub>1</sub>  
 Angelic acid, 135  
 Anhaline, *see* Hordenine  
 Anhydro-sugars, 206, 208  
 Anomers, 183, 185, 187  
 Anthocyanidins, 545-557  
 Anthocyanins, 545-557  
 Anthoxanthins, *see* Flavones  
 Anthracene, 339, 340, 341  
 Antibiotics, 140, 632-641  
*Anti*-compounds, 151  
 Antimony compounds, stereochemistry of, 169  
 Antipyrine, 426  
 Apocadalene, 304  
 Apocamphoric acid, 286, 293  
 Apoenzyme, 477  
 Apomorphine, 538  
 Arabinose, 177-179, 182, 192-193, 200, 232  
 Arabinotrimethoxyglutaric acid, 193, 194  
 Arbutin, 238  
 Arecaidine, 499-500  
 Arecoline, 499  
 Arginine, 452, 467, 478  
 Arndt-Eistert synthesis, 401, 417, 492, 550  
 Arrhenius equation, 64  
 Arsanilic acid, 632  
 Arsanthren, 167  
 Arsenicals (in medicine), 631-632  
 Arsenic compounds, stereochemistry of, 163-169  
 Arsphenamine, 631  
 Ascaridole, 266  
 Ascorbic acid, 208-214  
 Asparagine, 453  
 Aspartic acid, 52, 453  
 Association, 2, 4, 5, 9, 12, 14, 15, 16  
 As-spiro-bis-1:2:3:4-tetrahydroisoarsinolinium bromide, 165  
 Asymmetric carbon atom, 23, 30, 31, 32, 40, 41, 141, 142, 261, 263  
 Asymmetric decomposition, 85  
 Asymmetric solvent action, 54  
 Asymmetric synthesis, absolute, 85  
   partial, 79-85  
 Asymmetric transformation, 53-54, 79-80, 130, 131, 174, 183  
 Asymmetry, 20-24, 165-169  
 Atebrin, *see* Mepacrine  
 Atoxyl, 632  
 Atrolactic acid, 46, 81, 82-83, 510  
 Atropic acid, 509-510  
 Atropine, 509-516  
 Aureomycin, 638  
 Auwers-Skita rule, 94, 113, 118, 268, 269  
 Auwers-Skita rule of catalytic hydrogenation, 380, 381  
 Auxins, 418-419  
 Auxin *a* (auxentriolic acid), 418, 419  
 Auxin *b* (auxenolonic acid), 418, 419  
 Axerophthol, *see* Vitamin A<sub>1</sub>  
 Axial bonds, 110  
 Azaporphyrins, *see* Phthalocyanines  
 $\alpha$ -Azidopropionic dimethylamide, 85  
 Azines, 437-447  
 Azlactones, 431, 455-456, 635  
 Azlactone synthesis, 455-456, 464, 473, 633  
 Azobenzene, 160  
 Azoles, 421-437  
 Azoxybenzene, 160  
 Azulene, 307  
 Azulenes, 307
- B**
- $\beta$ -Series (in Steroids), 378  
 Barbier-Wieland degradation, 365, 366, 368, 382, 410  
 Barbitone, 439  
 Barbituric acid, 438-439, 440, 570, 574  
 Bardhan-Sengupta synthesis, 344  
 Beckmann rearrangement, 153-159  
 Beer's law, 14  
 Benzaldoximes, 149, 151-152, 156  
 Benzamidomalonic ester, 451  
 1:2-Benzanthracene, 349  
 Benzedrine, 491  
 Benzene hexachloride, 100, 103, 116  
*N*-Benzenesulphonyl-8-nitro-1-naphthylglycine, 54, 130  
 Benzidine, 126  
 Benzil dioximes, 149  
 Benzil monosemicarbazones, 160  
 Benzil monoximes, 154  
 Benzimidazole, 52, 429-430  
 Benzodiazines, 445-447  
 1:2-Benzohexacene, 349  
 3:4-Benzophenanthrene, 134  
 Benzophenone oxime, 157-158  
 Benzophenone-2:2':4:4'-tetra-carboxylic acid, 141  
   dilactone, 141  
 Benzopyrazole, *see* Indazole  
 Benzopyrylium chloride, 545  
*p*-Benzoquinone, 6  
 Benzothiazole, 432-433  
 Benzotriazole, 434  
 Benzoxazoles, 431  
 Benzoylacetone, 423  
 3- $\alpha$ -Benzoylacetyl-1:5-diphenylpyrazole, 423  
 Benzoyllecgonine, 517, 518  
 Benzoylformic acid, 81, 82-83, 154  
 Benzoylglycine, *see* Hippuric acid  
 3:4-Benzopyrene, 350  
 Benzyl chloride (hydrolysis of), 68  
 Benzyl chloroformate, 471  
 Benzylethylmethylphenylammonium iodide, 144

- Benzylethyl-1-naphthyl-*n*-propyl-  
 arsonium iodide, 164  
 Benzylethylpropylsilicyl oxide, 173  
 Benzylidene derivatives, 206, 511, 608  
 Benzylmethyl-1-naphthylphenyl-  
 arsonium iodide, 164  
 Benzylmethylphenylphosphine oxide, 162  
 Betaines, 461, 497  
 Bile acids, 360, 390-394  
 Bile pigments, 655-656  
 Bilirubic acid, 656  
 Bilirubin, 655  
 Biomolecular mechanism, 60  
 Bios, 612  
 Biosynthesis, 314-315  
   alkaloids, 541-544  
   amino-acids and proteins, 480-482  
   carbohydrates, 232-233  
   porphyrin, 654-655  
   purines, 586  
   sterols, 315, 389-390  
   terpenes, 315-317  
 Biotins, 612-615  
    $\alpha$ -Biotin, 612  
    $\beta$ -Biotin, 612-615  
 Bisabolene, 297  
 Bisnorcholanic acid, 366  
 Biuret reaction, 462  
 Bixin, 336  
 Bixindialdehyde, 328  
 Blanc's rule, 361, 367  
 Boat-axial bonds, 111  
 Boat-equatorial bonds, 111  
 Bogert-Cook synthesis, 344, 352, 358, 398  
 Boiling points, 4  
 Bond forces, 16  
 Bond lengths, 15, 16, 26, 162, 173  
 Borneols, 81, 279, 285, 289  
 Bornyl chlorides, 284, 285, 288  
 Bornylene, 285-288  
 Bornyl iodides, 279, 287  
 Bouveault-Blanc reduction, 254, 300, 301,  
   305, 312, 460  
 Bowsprit bonds, 111  
 Bredt's rule, 275  
 Bromocamphorsulphonic acids, 52, 144,  
   284  
 Bromocitraconimide, 659  
 2-Bromocyclohexanone, 114  
 2-Bromo-4:4-dimethylcyclohexanone, 114  
 Bromofumaric acid, 98  
 4-Bromogentisic acid decamethylene  
   ether, 132  
    $\beta$ -Bromolactic acid, 34  
    $\alpha$ -Bromo- $\beta$ -methylvaleric acid, 41-42  
   2-Bromo-5-nitroacetophenone, 154  
    $\alpha$ -Bromopropionic acid, 40, 71, 74-75  
 Bromosuccinic acid, 87  
 1-Bromotriptycene, 65  
 Bücherer hydantoin synthesis, 456  
 Buna N rubber, 319  
 Buna rubbers, 319  
 Buna S rubbers, 319  
*n*-Butane, 28, 110  
 Butan-2-ol, 82  
 Butenes, 101  
   *sec*.-Butyl bromide, 55, 56  
   4-*t*.-Butylcyclohexyl tosylate, 122  
   *tert*.-Butyl *n*-hexyl ketone, 81  
   *s*-Butylmercuric bromide, 24  
   *n*-Butylphenyl-*p*-carboxymethoxy-  
   phosphine sulphide, 162  
   2-Butyl phenyl ketone, 46, 47  
   Butyl rubber, 319
- C**
- Cadalene, 300-302, 304  
 Cadinene, 299-303  
 Caffeine, 580-583, 585  
 Calciferol, 384-386  
 Calciferyl-4-iodo-3-nitrobenzoate, 386  
 Camphane, 279, 285  
 Camphene, 285-288  
 Camphenic acid, 286, 288  
 Camphenilone, 286, 287  
 Camphenylic acid, 286  
 Campholide, 283  
 Camphor, 49, 55, 82, 279-284, 285  
 Camphoric acid, 279-281, 282, 287  
 Camphoronic acid, 280-281, 282  
 Camphoroxime, 50  
 Camphorsulphonic acids, 52, 85, 140, 170,  
   284  
 Cane sugar, *see* Sucrose  
 Carane, 271  
 4-Carbethoxy-4-phenylbispiperidinium-  
   1:1'-spiran bromide, 145  
 Carbobenzoxy (carbobenzyloxy) chloride,  
   471-472  
 Carbocamphenilone, 286  
 Carbohydrates, 176-233  
 Carbonium ions, 60-61  
 Carboxyapocamphoric acid, 285  
 2-*o*-Carboxybenzyl-1-indanone, 47  
 Carboxymethylethylmethylsulphonium  
   bromide, 169  
 Carboxymethylmethylphenyl-  
   selenonium bromide, 174  
 9-*p*-Carboxyphenyl-2-methoxy-9-  
   arsafluorene, 166  
 2-*p*-Carboxyphenyl-5-methyl-1 : 3-dithia-  
   2-arsaindane, 166  
*p*-Carboxyphenylmethyl ethylarsine  
   sulphide, 164  
 Carcinogenic hydrocarbons, 349, 350  
 Car-3-ene, 266, 272  
 Car-4-ene, 266, 272  
 Carene epoxide, 272  
 Carone, 272-273  
 Caronic acid, 273  
 Caro's acid (permonosulphuric acid), 97,  
   99, 658  
 Carotenes, 321-330  
    $\alpha$ -Carotene, 321, 322, 327, 330  
    $\beta$ -Carotene, 321-327, 329-330  
    $\gamma$ -Carotene, 322, 330  
 Carotenoids, 321-338  
    $\beta$ -Carotenone, 324  
   Carr-Price reaction, 321, 330  
 Carvacrol, 259, 281  
 Carvestrene, *see* Sylvestrene  
 Carvone, 259-262, 304  
 Carvotanacetone, 261  
 Carvoxime, 49, 262  
 Caryophyllene, 306-307  
 Cellulobiose, 201, 221, 225  
 Cellotriose, 224, 225  
 Cellulose, 16, 224-228  
 Centre of symmetry, 37-38

- Channel complex, 55  
 Chemotherapy, 627-641  
 Chenodeoxycholic acid, 391  
 Chitin, 232  
 Chitosamine, *see* Glucosamine  
 Chloramine T, 172  
 Chloramphenicol, 640-641  
 Chlorin-*e*, 658, 659, 660, 661, 662  
 1-Chloroapocamphane, 65  
 Chlorobutane, 24  
 Chlorocaffeine, 581-582, 583  
 Chlorocrotonic acids, 92  
 Chlorocyclohexane, 111, 123  
 Chlorocyclohexanones, 124  
 $\alpha$ -Chloroethylbenzene, 47-48  
 Chloromethylation, 425, 426, 536  
 Chloromycetin, *see* Chloramphenicol  
 2-Chloro-5-nitrobenzaloximes, 152  
 2-Chloro-octane, 55  
 2-*p*-Chlorophenacyl-2-phenyl-1:2:3:4-tetrahydroiso-arsinolinium bromide, 164  
 Chlorophylls, 321, 467, 646, 656-662  
 Chlorophyll-*a*, 657-662  
 Chlorophyll-*b*, 657, 658, 662  
 Chlorophyllase, 656  
 Chlorophyllide-*a*, 657-658, 659  
 Chlorophyllide-*b*, 657-658  
 Chloroprene, 320  
 Chloroquine, 631  
 Chlorosuccinic acid, 69  
 Chlorosulphinates, 73-74  
 Chlorotheophylline, 585  
 3-Chloro-1:3:3-triphenylprop-1-yne, 348  
 Cholic acid, 360, 366, 367, 390, 392  
 Cholecalciferol, *see* Vitamin D<sub>3</sub>  
 Choleic acids, 394  
 Cholenic acid, 392  
 Cholestanane, 360, 377, 381, 391  
 Cholestanedione, 362  
 Cholestanetriol, 362, 363-364  
 Cholestanol, 359, 360, 363, 372, 378, 379, 380, 381, 383, 391, 395  
 Cholestanone, 360, 361, 363, 379, 391  
 Cholestenone, 362, 380, 392  
 Cholesterol, 315, 359-376, 379, 380, 387, 389, 391, 392, 397, 411  
 Cholic acid, 391, 394  
 Choline, 619  
 Chromans, 621  
 Chromatography, 54, 55, 149, 188, 214, 227, 228, 233, 322, 366, 457, 476, 482, 545, 595, 619, 657  
 Chromoproteins, 464, 643  
 Chrysene, 351-352, 358, 360, 369, 398  
 Chrysin, 559  
 Cinchene, 523  
 Cincholoipon, 525  
 Cincholoiponic acid, 524-526  
 Cinchomeronic acid, 506  
 Cinchonidine, 52, 55, 80, 527  
 Cinchonine, 52, 55, 523-528  
 Cinchoninic acid, 523, 524, 527  
 Cinchoninone, 523, 527, 528  
 Cinchotenine, 523  
 Cinchotoxine, 528  
 1:4-Cineole, 265  
 1:8-Cineole, 265  
 Cineolic acid, 265  
 Cinnamaloxime, 156  
 Cinnamic acid, 96, 99, 107  
 Cinnolines, 445  
 Circular dichroism, 85  
*Cis*-addition, 96-99  
 Cisoid conformation, 27  
*Cis-trans* isomerism, *see* Geometrical isomerism  
 Citraconic acid, 91  
 Citral, 247-251, 252  
 Citral-*a*, 250  
 Citral-*b*, 250  
 Citric acid cycle, *see* Krebs cycle  
 Citronellal, 254  
 Citronellic acid, 254  
 Citronellol, 255  
 Claisen condensation, 269, 407, 508, 559, 566, 603  
 Claisen-Schmidt reaction, 251, 504, 561, 562, 563  
 Clathrate, 55-56  
 Clemmensen reduction, 310, 342, 351, 360, 367, 369, 391, 415, 416, 614  
 Cocaine, 517-520  
 $\psi$ -Cocaine, 519  
 Co-carboxylase, 603  
 Codehydrogenase I and II, 617  
 Codeine, 537-541  
 Codeinone, 537, 538, 540, 541  
 Coenzyme A, 315-317, 598  
 Co-enzymes, 477, 479, 598  
 Co-enzymes I and II, 598  
 Collagens, 467  
 Colligative properties, 1  
 Colophony, 309  
 Compensation, external, 40, 57-58  
     internal, 42, 57-58  
 Configuration, 11, 17, 20, 29, 32, 41, 70-71, 91, 185-187  
     absolute, 17, 32, 130, 140, 510, 520  
     correlation of, 34-37, 50, 55, 70, 82, 292, 378, 379, 458  
     specification of, 35-37  
 Conformation, 21, 26-30, 37  
     boat, 109-112  
     chair, 109-112  
 Conformational analysis, 17, 28-30  
     asymmetric synthesis, 82-84  
     benzene hexachloride, 100, 103, 116  
     cyclohexanes, 109-114, 121-124  
     decalins, 116-121  
     2-decalols, 118-121  
     menthols, 268  
     pyranosides, 201-203  
     steroids, 380-382  
     tropine, 514-516  
 Conhydrine, 502  
 $\psi$ -Conhydrine, 502  
 $\gamma$ -Coniceine, 502  
 Coniine, 501  
 Conjugation, 8  
 Constancy of valency angle, principle of, 26  
 Constellation, 28  
 Constitutive properties, 1, 6, 7, 10  
 Conyryne, 501  
 Copaene, 301, 303  
 Copper phthalocyanine, 663  
 Coprostanane, 366, 377, 381, 392  
 Coprostanol, 359, 360, 381, 392, 393  
 Coronene, 354-357

- Corticosterone, 416  
 Cortisone, 417-418  
 Cotton effect, 10, 85  
 Coumarans, 560, 621  
 Coumaric acid, 92  
 Coumarin, 92, 548  
 Coumarinic acid, 92  
 Cram's rule, 84  
 Crocetin, 337  
 Crocin, 337  
 Crotonic acid, 90, 92, 95  
 Crotyl alcohol, 253  
 Crotyl bromide, 253  
 Cryptopyrrole, 643, 645, 647, 656, 658  
 Cryptopyrrolecarboxylic acid, 645, 656  
 Cryptoxanthin, 335  
 $\psi$ -Cumenol, 619  
 Cuminal, 305  
 Curtius reaction (rearrangement), 454, 613  
 Cuscohygrine, 496-497  
 Cusparine, 521  
 Cyanidm chloride, 545, 546, 551-552, 555, 564  
 Cyanin, 551, 552-553  
 Cyanoacetic ester, *see* Ethyl cyanoacetate  
 Cyanocobalamin, *see* Vitamin B<sub>12</sub>  
 Cyclobutane derivatives, stereochemistry of, 107-108, 276  
 Cyclodecane-1:6-dione, 307  
 Cycloheptatriene, *see* Tropilidene  
 Cyclohexane, 109-112, 345  
 Cyclohexane-1-carboxyl-2-propionic acid, 118  
 Cyclohexane derivatives, stereochemistry of, 100, 103, 109-116, 121-124  
 Cyclohexane-1:2-diacetic acid, 118  
 Cyclohexanone-4-carboxylic acid, oxime of, 151  
 Cyclopentane derivatives, stereochemistry of, 108-109, 283, 371  
 Cyclopentanone oxime, 155  
 1:2-Cyclopentenophenanthrene, 358  
 Cyclopropane derivatives, stereochemistry of, 105-107  
 Cyclopropane-1:1:2-tricarboxylic acid, 287  
 Cyclopropane-1:2:3-tricarboxylic acid, 278, 287  
 Cysteine, 432, 450, 452, 633  
 Cystine, 450, 452, 466, 468, 614  
 Cytidine, 589, 592  
 Cytidylic acid, 589, 593  
 Cytochrome, 479  
 Cytosine, 443-444, 588, 589, 595
- D**
- Daidzein, 565, 566  
 Dakin-West reaction, 460  
 Darapsky synthesis, 454  
 Darzens glycidic ester condensation, 277, 331  
 Debye forces, 2  
 Decahydroisoquinolines, 119  
 Decahydronaphthalenes, *see* Decalins  
 Decahydroquinolines, 119  
 Decalins, 116-120, 159, 345  
 2-Decalol, 118-121, 159, 307  
 Decalones, 118-119, 380  
 Dehydroascorbic acid, 209-210, 477  
 7-Dehydrocholesterol, 387  
 11-Dehydrocorticosterone, 416  
 Dehydrodeoxycholic acid, 370  
 Dehydroepiandrosterone, 396, 397, 411  
 Dehydrogenases, 477, 479, 480  
 Dehydrogenation (with metals), 307, 311, 342, 344, 345-347, 357, 536  
     *see also* Selenium and Sulphur dehydrogenation  
 Dehydrolithocholic acid, 393  
 Dehydronorcholene, 367  
 Delphinidin chloride, 545, 546, 555  
 Delphinin, 555  
 Denaturation, 465, 467  
 Dendrolasin, 244  
 Deoxybiliary acid, 370  
 Deoxycholic acid, 367, 370, 391  
 11-Deoxycorticosterone, 416  
 11-Deoxy-17-hydroxycorticosterone, 416  
 Deoxyribonucleic acids (D.N.A.), 587, 595-596  
 2-Deoxyribose, 587, 591  
 Depsides, 566  
 Dethiobiotin, 613  
 Deuterium compounds, 24  
 Deuterohæmin, 652  
 Deuteroporphyrin, 651  
 Dextrin, 231  
 Dextrose, *see* Glucose  
 $\omega$ :4-Diacetoxyacetophenone, 549, 554  
 Dialuric acid, 440, 570  
 Diamagnetism, 13  
 2:2'-Diamino-6:6'-dimethyldiphenyl, 127, 138  
 4:5-Diaminouracil, 574  
 Dianthronylidene, 134  
 Diastase, 228, 229  
 Diastereoisomers, 20, 41, 80  
 Diazines, 437-445  
 Diazoacetic ester, 278, 424, 426, 662  
 Diazoates, 160  
 Diazocyanides, 160  
 Diazoketones, *see* Arndt-Eistert synthesis  
 Diazomethane, 187, 210, 366, 401, 404, 417, 421, 427, 522, 550, 590, 615, 634  
 Diazosulphonates, 160  
 1:2:5:6-Dibenzanthracene, 349  
 2:3-Dibromobutane, 76, 101  
 $\alpha$ : $\beta$ -Dibromobutyric acid, 40  
 Dibromocotinine, 506-507  
 Dibromofumaric acid, 96  
 Dibromomaleic acid, 96  
 2:4-Dibromo-2-methylbutane, 248  
 $\alpha$ : $\alpha'$ -Dibromosuccinic acid, 97  
 Dibromotocinine, 506-507  
 Dichloroadenine, 592  
 6:6'-Dichlorodiphenic acid, 127  
 4:4'-Dichlorodiphenyl, 127  
 1:2-Dichloroethane, *see* Ethylene chloride  
 2:6-Dichloro-3-nitrobenzaldoxime, 153  
 2:4-Dichloropyrimidine, 440  
 Dieckmann reaction, 278, 282, 500  
 Dielectric constant, 2, 67  
 Diels-Alder reaction, 99, 259, 288, 299, 312, 313, 322, 356, 371, 383  
 Diels' hydrocarbon, 358, 360, 367, 369, 412  
 2:2'-Difluoro-6:6'-dimethoxydiphenyl-3:3'-dicarboxylic acid, 136  
 2:2'-Difluoro-6:6'-dinitrodiphenyl, 137  
 6:6'-Difluorodiphenic acid, 137  
 Digitonin, 359, 412



- Dihydrocarveol, 260-261  
 Dihydrocholesterol, *see* Cholestanol  
 9:10-Dihydro-3:4-5:6-dibenzophenanthrene, 134  
 22:23-Dihydroergosterol, 387  
 Dihydroeudesmene, 306  
 Dihydroeudesmol, 304, 306  
 Dihydro-*ψ*-ionone, 296  
 Dihydroxy- $\beta$ -carotene, 324  
 Dihydroxymaleic acid, 210  
 4:5-Dihydroxyuracil, 573  
 2:6-Di-iodopurine, 576  
 3:5-Di-iodotyrosine, 452, 465  
 Diketogulonic acid, 210  
 Diketopiperazines, 456, 461, 471  
 Dilituric acid, 439-440  
 Dimercaptodiphenyl, 127  
*ω*:4-Dimethoxyacetophenone, 550  
 6:7-Dimethoxyisoquinoline-1-carboxylic acid, 534, 535  
 $\beta$ : $\beta$ -Dimethylacrylic ester, 273  
 $\alpha$ : $\alpha$ -Dimethyladipic acid, 251  
 $\beta$ : $\beta$ -Dimethyladipic acid, 251  
 Dimethylalloxan, 580, 585  
 2-Dimethylaminoguanine, 588  
 Dimethylbenzimidazole, 618  
 3:3-Dimethylbutan-2-ol, 82  
 3:3-Dimethylbutan-2-one, 81  
 Dimethylcadalene, 301-302  
 1:2-Dimethylcyclohexane, 113  
 1:3-Dimethylcyclohexane, 113  
 6:6-Dimethylcyclohexane-2:4-dione-1-carboxylic ester, 282  
 2:5-Dimethylcyclopentane-1-carboxylic acid, 93, 108-109  
 2:5-Dimethylcyclopentane-1:1-dicarboxylic acid, 93, 108-109  
 2:5-Dimethylcyclopentanone, 358  
 3':7-Dimethylcyclopentenophenanthrene, 363  
 Dimethyldiketopiperazine, 38  
 Dimethyldithiocarbamate (zinc salt), 319  
 2:3-Dimethylglucose, 227, 230  
 $\alpha$ : $\alpha$ -Dimethylglutaric acid, 251, 322  
 $\beta$ : $\beta$ -Dimethylglutaric acid, 282  
 1:6-Dimethyl-4-isopropynaphthalene, 300  
 Dimethylmaleic acid, 620  
 Dimethylmalonic acid, 322  
 1:6-Dimethylnaphthalene, 330  
 2:3-Dimethylnaphthalene, 385  
 2:6-Dimethylnaphthalene, 323  
 1:2-Dimethylphenanthrene, 368, 371, 402  
 Dimethylphenylarsine, 164  
 Dimethylpiperazine, 145  
 Dimethylsaccharic acid, 218  
 $\alpha$ : $\alpha$ -Dimethylsuccinic acid, 251, 322  
 Dimethyltartaric acid, 190, 193, 195, 218, 591  
 Dimethylthreonic acid, 211  
 Dimethylurea, 580, 583  
 Dimethyluric acid, 584  
 1:1'-Dinaphthyl-5:5'-dicarboxylic acid, 130  
 1:1'-Dinaphthyl-8:8'-dicarboxylic acid, 130  
 $\alpha$ : $\gamma$ -Di-1-naphthyl- $\alpha$ : $\gamma$ -diphenylallene, 139  
 $\alpha$ : $\gamma$ -Di-1-naphthyl- $\alpha$ : $\gamma$ -diphenylallyl alcohol, 139  
 6:6'-Dinitrodiphenic acid, 126, 127, 139  
 Diosgenin, 412  
 Dipentene, *see* Limonene  
 Diphenic acid, 128  
 Diphenyl, 16, 126, 139, 339  
 Diphenyl compounds, stereochemistry of, 126-139  
 Diphenyl-2:2'-disulphonic acid, 128  
 Diphenylene disulphide, 127  
 Diphenylguanidine, 319  
 3:4-Diphenyliso-oxazole-5-carboxylic acid, 154  
 1:4-Diphenylpiperazine dioxide, 147  
 DPN, 598  
 Dipolar ions, 460, 461, 500  
 Dipole-dipole effect, 2  
 Dipole moments, 2, 4, 9, 11-13, 15, 25, 27, 29, 30, 67-69, 72, 93, 94, 95, 127, 147, 148, 161, 436, 460, 515  
 Dipyrlylmethanes, 648  
 Dipyrlylmethenes, 647-649  
 Disaccharides, 183, 214-223, 236, 237  
 Disinfectants, 627  
 Dispersion forces, 2, 5  
 Displacement reactions, 60  
 Dissociation equilibrium, 146, 162, 164, 166  
 Dissymmetry, 20-22  
 Distance rule, 10  
 5:10-Di-*p*-tolyl-5:10-dihydroarsanthren, 167  
 Duroquinol, 619, 620  
 Duroquinone, 619, 620
- E**
- Ebonite, 319  
 Ecgonine, 517-518  
 $\psi$ -Ecgonine, 519  
 Ecgoninic acid, 517, 518  
 Eclipsed form, 26-30, 101, 102, 110  
 Elastins, 467  
 Elbs reaction, 341, 351  
 Electron diffraction, 3, 17, 25, 30, 111, 135, 166, 168  
 Electron paramagnetic resonance, 17  
 Electron spin resonance, 17  
 Elements of symmetry, *see* Symmetry  
 Elimination reactions, stereochemistry of, 100-103, 122-123  
 Emde degradation, 486  
 Emulsin, 84, 184, 215, 221, 223, 224, 234, 235, 237, 238, 239  
 Enantiomorphs, 10, 15, 17, 20-21, 25, 32, 128  
 End-group assay, 227-228, 229, 231  
 Endo-compounds, 285  
 End-on approach, 72  
 Enzymes, 53, 84, 184, 213, 215, 218, 221, 223, 224, 228, 230, 231, 232, 235, 237, 238, 239, 240, 314-317, 449, 467, 475, 477-479, 587, 590, 693, 694, 598, 603, 634, 656  
     *see also individuals*  
 Ephedrines, 489-491  
 $\psi$ -Ephedrines, 490  
 Epi-series (in Steroids), 378  
 Epiandrosterone, 395, 396  
 Epicholestanol, 379, 381, 395  
 Epicoprostanol, 380, 381, 393  
 Epimerisation, 45

- Epinephrine, *see* Adrenaline  
 Epoxides, 99, 207, 217, 301, 344, 382, 403, 446, 496  
 Equatorial bonds, 110  
 Equilenin, 405-407  
 Equilin, 407  
 Ergocalciferol, *see* Calciferol  
 Ergostanol, 382  
 Ergosterol, 359, 382-384, 414  
 Ergosterone, 414  
 Erythro-3-bromobutan-2-ol, 76-77  
 Erythrose, 176-177  
 Essential oils, 242, 244  
     *see also* Oils  
 17 $\alpha$ -Ethinylcestradiol, 405  
 Ethyl acetamidomalonate, 451, 454  
 Ethyl acetoacetate syntheses, *see* Acetoacetic ester syntheses  
 17-Ethyl $\alpha$ -cholane, 415  
 Ethyl  $\alpha$ -bromopropionate, 85  
 Ethyl  $\alpha$ -chlorocrotonate, 95  
 Ethyl chloroformate, 471, 567, 574, 577, 607  
 Ethyl cyanoacetate syntheses, 273, 278, 454, 574, 578, 579, 583, 584, 586, 611  
 Ethyl cyclohexane-2-carboxylate, 344  
 Ethyldimethylphenylarsonium iodide, 164  
 Ethylene-1:2-bis(*n*-butylmethylphenylarsonium) picrate, 165  
 Ethylene-1:2-bis(*n*-butylphenylarsine)-dichloropalladium, 165  
 Ethylene-1:2-bis(*n*-butylphenylarsine sulphide), 165  
 Ethylene chloride, 27  
 Ethyl fumarate, 85, 424  
 Ethylisopropylacetaldehyde, 388  
 1-Ethyl-7-isopropylphenanthrene, 312  
 Ethyl malonate syntheses, 282, 300, 304, 343, 406, 438, 439, 450, 451, 454, 495  
 Ethyl  $\alpha$ -methylbutyrate, 79  
 Ethylmethylmaleimide, 645, 658  
 Ethylmethylmalonic acid, 79-80  
 Ethylmethyl-1-naphthylamine oxide, 147  
 Ethylmethylphenacetylsulphonium picrate, 170  
 Ethylmethylphenylamine oxide, 147  
 Ethylmethylphenylphosphine oxide, 162  
 Ethylmethyl-*n*-propylstannonium iodide, 174  
 Ethylphenylisopropylgermanium bromide, 174  
 Ethyl *p*-toluenesulphinate, 170  
 Ethyl triphenylmethylpyrophosphonate, 162  
 Etianic acid, 366  
 $\beta$ -Eucaine, 520  
 Eudalene, 304-305  
 Eudesmol, 304-306  
 Evipan, 439  
 Exo-compounds, 285  
 External compensation, *see* Compensation  
 Extinction coefficient, 14
- F**
- FAD, 598  
 Faraday effect, 10  
 Farnesal, 295, 296  
 Farnesene, 295, 297  
 Farnesenic acid, 296  
 Farnesol, 296-297, 300, 308  
 Farnesyl bromide, 313  
 Fenchane, 271  
 $\alpha$ -Fenchene, 293  
 $\alpha$ -Fenchocamphorone, 293  
 Fenchone, 293-294  
 Fenethyl alcohol, 293  
 Fibrous proteins, 469-470  
 Fittig reaction, 339  
 Flagpole bonds, 111  
 Flavanone, 561  
 Flavins, 604  
 Flavone, 558-560  
 Flavones, 557-565  
 Flavonol, 560-562  
 Flavonols, 560, 563  
 Flavylum chloride, 545  
 Flexible molecules, 28  
 Fluorene, 340  
 1-Fluoro-2:4-dinitrobenzene, 459, 476  
 Folic acid complex, 610-612  
 Formamidone, 441, 578  
 Formyl hydrazide, 434  
 Four-centre reaction, 74  
 Free radicals, 13, 15, 17  
 Free rotation, principle of, 15, 26-30  
 Frequency factor, 64  
 Friedel-Crafts reaction, 340  
 Fructose, 31, 180-181, 182, 193-195, 197, 198, 206, 215, 217, 224, 232  
 Fructosides, 184  
 Fumaric acid, 87-88, 91, 92, 94, 97, 103  
 Furanose sugars, 190-201, 215, 591  
 Furazans, 434  
 Furfuraldehyde, 209
- G**
- Gabriel's phthalimide synthesis, 449-451  
 Galactans, 232  
 Galactose, 179-180, 182, 187, 191, 205, 221, 222, 224, 232, 545  
 Galacturonic acid, 232  
 Galipine, 521-522  
 Galipoline, 522  
 Gallic acid, 550, 555, 567, 568  
 Gattermann aldehyde synthesis, 551, 649  
*Gauche* conformation, 27-28  
 Genistein, 565  
 Gentianose, 223, 224  
 Gentiobiose, 223, 224, 237  
 Geometrical isomerism, 3, 5, 12, 14, 16, 18, 20, 38, 87-124, 131, 142, 145, 146, 147, 168, 172  
     determination of configuration, 91-103, 105-124  
     nomenclature, 89  
 C=C, 87-103, 250, 252, 334, 336, 384, 408  
 C=N, 149-160  
 N=N, 160-161  
 reduced ring systems, 105-124, 263, 264, 276, 283, 530  
 terphenyls, 132  
     *see also* Additive reactions, Elimination reactions, Stereomutation
- Geranial, *see* Citral-a  
 Geranic acid, 247, 248, 254  
 Geraniol, 247, 252, 297, 300, 316  
 Geranylacetone, 296, 297

- Germanium compounds, stereochemistry of, 174  
 Geronic acid, 251, 322, 329, 330  
 Gestogens, 409-415  
 Girard's reagents, 398, 416  
 Globin, 643  
 Globular proteins, 468-469  
 Globulins, 466  
 Glucal, 208  
 Glucosamine, 208, 232, 637  
 Glucose, 30, 31, 37, 179-180, 181-182, 183, 184, 185, 188-192, 198, 199, 203-208, 213, 215, 216, 218, 221, 222, 224, 228, 232, 236, 237, 238, 239, 429, 545, 551, 553, 555, 556, 558  
 $\alpha$ - and  $\beta$ -forms, 183, 185-186, 198  
 Glucosides, 184  
 Glucosone, 181  
 Glutamic acid, 52, 450, 451, 453, 455, 610-612  
 Glutamine, 453  
 Glutelins, 466  
 Glyceraldehyde, 31-36, 176, 233, 458  
 Glyceric acid, 34, 199, 216, 233  
 Glycidic esters, *see* Darzens glycidic ester condensation  
 Glycine, 390, 434, 449, 454, 460, 461, 466, 571, 581  
 Glycocholic acid, 390  
 Glycogen, 231  
 Glycoproteins, 464  
 $\alpha$ -Glycosans, *see* Anhydro-sugars  
 Glycosides, 15, 172, 184, 186, 187, 234-240, 412, 545, 558, 567, 589  
 Glycylglycine, 471  
 Glyoxalines, *see* Imidazoles  
 Gramine, 451, 497  
 Grignard reagents, 81-84  
 Guaioil, 307  
 Guanidine, 580, 611  
 Guanine, 579-580, 588, 590, 595  
 Guanosine, 589, 590, 591  
 Guanylic acid, 589, 593  
 Gulose, 179-180  
 Gums, 232  
 Gutta-percha, 318  
 Guvacine, 499  
 Guvacoline, 499
- H**
- Hæm, 643  
 Hæmatin, 477, 643  
 Hæmatinic acid, 645, 656, 658  
 Hæmatoporphyrin, 645, 653  
 Hæmin, 643, 645, 646, 647, 651-653  
 Hæmoglobin, 467, 470, 643-653, 656  
 Hæmopyrrole, 643, 658  
 Hæmopyrrolecarboxylic acid, 645, 656  
 Haloform reaction, 261, 275, 282, 299, 303, 414, 599  
 Haworth synthesis, 341-343  
 Helicin, 239  
 Hemi-celluloses, 232  
 Hemimellitene, 311  
 Hemipinic acid, 534  
 Heptacene, 349  
 Herzig-Meyer method, 485, 506  
 Heteroauxin, 419  
 Heterocyclic compounds, 421-448  
 Hexacene, 349  
 Hexachlorocyclohexane, 116  
 Hexahydrocinchomeric acid, 524  
 Hexahydrofarnesol, 308  
 Hexahydrofarnesyl bromide, 308, 313  
 Hexahydroisophthalic acid, 115  
 Hexahydrophthalic acid, 93, 114  
 Hexahydroterephthalic acid, 92, 115  
 Hexoestrol, 409  
 Hexoses, *aldo*-, 179-180  
   *keto*-, 180-181  
 Hexuronic acid, *see* Ascorbic acid  
 Hippuric acid, 455  
 Hirsutidin chloride, 546, 556-557  
 Hirsutin chloride, 557  
 Histidine, 21, 453, 467  
 Histones, 467, 587  
 Hofmann degradation, 454  
 Hofmann exhaustive methylation, 278, 462, 486-487, 489, 491, 512, 513, 530, 614  
 Hofmann rearrangement, 429  
 Holoenzyme, 477  
 Homatropine, 516  
 Homocamphoric acid, 233  
 Homomeroquinene, 530  
 Homoretene, 312  
 Homoterpenyl methyl ketone, 257  
 Homoveratric acid, 536  
 Homoveratrylamine, 536  
 Hordenine, 491-492  
 Hormones, cortical, 415-418  
   *sex*, 394-415  
   *see also* Auxins, Thyroxine, Adrenaline  
 Hudson's isorotation rules, 186  
 Hudson's lactone rule, 186, 192, 193  
 Humulene, 85, 299  
 Hybridisation of orbitals, 11, 26, 47, 64, 65, 88-89, 98, 104, 139, 143, 147, 148-149, 168, 173, 348  
 Hydatoic acid, 461  
 Hydantoin, 141, 461, 570, 581  
 Hydramine fission, 489, 528  
 Hydrastine, 537  
 Hydrazoic acid, 433, 436, 455  
 Hydrindanols, 120  
 Hydrocarbostyryl-3-carboxylic acid, 54  
 Hydrogen bonding, 2-3, 4, 8, 15, 226, 468-469, 515  
 Hydrorubber, 317  
 Hydroxyætiocolanone, *see* 5-Isoandrosterone  
 Hydroxyallocholanic acid, 382  
*o*-Hydroxybenzaldehyde, 548  
 Hydroxycholestanedione, 362  
*o*-Hydroxycinnamic acid, 92  
 17-Hydroxycorticosterone, 416  
 2-Hydroxy-4:6-dimethoxybenzaldehyde, 551  
 7-Hydroxy-1:2-dimethylphenanthrene, 402  
 $\alpha$ -Hydroxyethylbenzene, 71, 73  
 $\beta$ -Hydroxyglutamic acid, 453  
 7-Hydroxyisoquinoline, 530  
 5-Hydroxymethylcytosine, 588  
 $\alpha$ -Hydroxy- $\alpha$ -methyl- $\alpha'$ -isopropyladipic acid, 270  
 7-Hydroxy-8-methylisoquinoline, 530

- Hydroxynorallocholic acid, **382, 383, 388**  
*β*-Hydroxy-*β*-phenylbutyric acid, **81**  
 17-*α*-Hydroxyprogesterone, **415**  
 Hydroxyproline, **453, 455**  
*α*-Hydroxypropionic acid, **75**  
 Hydroxypyruvic acid, **216**  
 5-Hydroxyuracil, **573**  
 Hygrine, **495-496**  
 Hygrinic acid, **495, 508**  
 Hydoexychoic acid, **391**  
 Hyoscine, **516-517**  
 Hyoscyamine, **509**  
 Hypoxanthine, **578-579**
- I**
- Idose, **179-180**  
 Imidazoles, **428-429, 569, 576, 577**  
 Iminazole, *see* Imidazoles  
 Indazoles, **427**  
 Indican, **235**  
 Indole-3-acetic acid, **419**  
 Indoxyl, **235**  
 Induced dipoles, **2, 12**  
 Induction effect, **2**  
 Infra-red spectra, *see* Absorption spectra  
 Inhibitors, **479**  
 Inner salts, **460**  
 Inositols, **115**  
 Intensity of magnetisation, **12**  
 Internal compensation, *see* Compensation  
 Inulin, **232**  
 Inversion, *see* Walden inversion  
 Invertase, **215, 224**  
 Invert sugar, **217**  
 Iodogorgic acid, **452**  
 2-Iodo-octane, **71**  
*α*-Ionone, **251, 327**  
*β*-Ionone, **251, 322, 323, 326, 327, 330, 333**  
*γ*-Ionone, **252**  
*ψ*-Ionone, **251**  
 Ion-pairs, **67**  
 Iron, **252**  
 Isoalloxazines, **448, 604**  
 Isoandrosterone, *see* Epiandrosterone  
 5-Isoandrosterone, **393, 395**  
 Isoborneols, **82, 284-285**  
 Isobornylane, **271**  
 Isobornyl halides, **285, 288, 289**  
 Isobutylethylmethylpropylammonium chloride, **144**  
 Isocamphane, **271**  
 Isocamphoric acid, **283**  
 Isocrotonic acid, **90, 92**  
 Isoelectric point, **461, 466**  
 Isoequilenin, **407**  
 Isoergosterone, **414**  
 Isoflavones, **565-566**  
 Isogeronic acid, **251, 327**  
 Isohexyl methyl ketone, **364**  
 Isoindole, **664**  
 Isoleucine, **450, 452, 455**  
 Isolithobilianic acid, **393**  
 Isomaltose, **230**  
 Isomerism, rotational, **28**  
   *see also* Conformational analysis  
 Isonicotinic acid, **505-506**  
 Iso-oxazoles, **153, 154, 430**  
 Isopelletierine, **502**  
 Isopentanethiol, **53**  
 Isopentyl carbamate, **49**  
 Isoprene, **242, 259, 317**  
 Isoprene rule, **242, 266, 295, 305, 308, 315, 317**  
*α*-Isopropylglutaric acid, **270**  
*β*-Isopropylglutaric acid, **262**  
 Isopropylidene derivatives (of sugars), **203-206, 213, 372, 608**  
 Isopropylmalonic acid, **25**  
 Isopropylsuccinic acid, **261**  
 Isopulegone, **270**  
 Isoquinoline, **156, 486, 505, 616**  
 Isoserine, **33**  
 Isostilbene, **96**  
 Isothiazoles, **433**  
 Isotopic asymmetry, **24**  
 Isotopic indicators, **24, 47, 62, 71, 73, 214, 232, 315, 316, 389, 458, 566, 575, 586, 654-655**
- J**
- Japp-Klingermann reaction, **455**
- K**
- Kairolin oxide, **147**  
 Keesom forces, **2, 5**  
 12-Ketocholic acid, **367**  
 2-Ketogulonic acid, **213**  
 Ketomethylic acid, **268**  
 Ketoses, **180-181**  
 Ketoximes, stereochemistry of, **149-151, 153-159**  
 Kiliani reaction, **33, 82, 177, 179**  
 Kinases, **479**  
 Knorr pyrrole synthesis, **643-645**  
 Kostanecki synthesis, **559, 561, 563**  
 Krebs cycle, **480, 655**  
 Kuhn-Rothe methyl side-chain determination, **323, 336, 608**
- L**
- Lactase, **221**  
 Lactic acid, **35, 46, 54, 70-71, 81**  
 Lactoflavin, *see* Vitamin B<sub>2</sub>  
 Lactols, **182**  
 Lactose, **54, 149, 201, 221**  
 Lævulaldehyde, **246, 250, 296, 317, 318, 625**  
 Lævulic acid, **247, 248, 298, 313, 317, 318, 327, 329**  
 Lævulose, *see* Fructose  
 Lanoline, **359**  
 Lanosterol, **389**  
 Latex, **317**  
 Laudanine, **537**  
 Laudanosine, **55, 537**  
 Lavandulol, **242**  
*L. casei* factors, **610-612**  
 Lepidine, **523, 534**  
 Leucine, **450, 451, 452, 455**  
 Leucopterin, **612**  
 Levopimaric acid, **312, 313**  
 Liebermann-Burchard reaction, **359**  
 Limonene, **47, 262-263, 272, 300**  
 Linalool, **253-254**  
 Lipoproteins, **467**

- Lithium aluminium hydride (use of), 24, 82, 212, 326, 333, 334, 335, 361, 382, 387, 402, 403, 416, 460, 475, 493, 515, 565
- Lithobiliaic acid, 393
- Lithocholic acid, 391, 392-394
- Loiponic acid, 524-525
- London forces, 2
- Lumichrome, 605-606
- Lumi-lactoflavin, 604-605
- Luminal, 439
- Lumisterol, 384
- Lutein, 321, 336
- Lycopenal, 328
- Lycopene, 327-329
- Lycophyll, 336
- Lycoxanthin, 335
- Lysine, 450, 451, 453, 466
- Lyxose, 179-180
- M**
- M and B*, 628
- Macleod equation, 6
- Magnetic induction, 13
- Magnetic optical rotation, 10
- Magnetic permeability, 13
- Magnetic susceptibility, 12-13, 354
- Malamic acid, 33
- Maleic acid, 87-88, 91, 94, 97, 98, 103
- Maleic dialdehyde, 437
- Malic acid, 33, 34, 50, 69, 87
- Malonic ester syntheses, *see* Ethyl malonate syntheses
- Maltase, 184, 215, 218
- Maltol, 638
- Maltose, 201, 218-221, 228, 229, 230, 231
- Malvidin chloride, 546, 556
- Malvin, 556
- Mandelic acid, 46, 49, 54, 81, 237, 516, 615
- Mandelonitrile, 84, 237
- Mannans, 232
- Manninotriose, 224
- Mannose, 31, 179-180, 182, 191, 232
- Marrianolic acid, 402
- Meerwein-Ponndorf-Verley reduction, 81, 130, 285, 402, 641
- Melibiose, 189, 201, 222, 224
- Melting points, 3-4
- Menschutkin reaction, 68
- p*-Menthane, 255, 267, 268
- Menthol, 81, 170, 267-268, 269
- Menthone, 268-269
- Menthoxyacetyl chloride, 53
- Menthylhydrazine, 53
- Menthyl mandelate, 55
- N*-(-)-Menthyl-*p*-sulphamylbenzoyl chloride, 53
- Mepacrine, 630
- 2-Mercaptobenzothiazole, 319, 433
- Mercaptosuccinic acid, 50
- Meroquinene (meroquinene), 523-527, 529
- Mesaconic acid, 91
- Mescaline, *see* Mescaline
- Mesityl oxide, 282
- Mesobilirubin, 656
- Meso*-compounds, 20, 43, 44, 106, 108, 109, 115, 116
- Mesoerythritol*, 177
- Meso*inositol, 115, 612, 619
- Meso*-ionic compounds, 434-437
- Mesomechanism, 62
- Mesoporphyrin, 645, 659
- Mesotartaric acid*, 33, 43, 58, 97
- Mesoxalic acid, 569, 570, 580
- Metahemipinic acid, 533-534
- Metalloproteins, 467
- Methionine, 450, 451, 452, 456, 457
- Method of Molecular Rotation Differences, 378-379
- Methoxycaffeine, 581-582
- 7-Methoxy-1:2-*cyclopentenophenanthrene*, 390
- 7-Methoxy-3':3'-dimethyl-1:2-*cyclopentenophenanthrene*, 399, 405
- Methoxyhydroxymethyldiglycolaldehyde, 199, 200
- 7-Methoxy-3'-methyl-1:2-*cyclopentenophenanthrene*, 404
- 4-Methoxy-2-methylquinoline, 521
- 6-Methoxy-4-methylquinoline, 529-530
- 4-Methoxyquinoline-2-carboxylic acid, 521
- 4-Methoxy-2:5-toluquinone, 371
- Methyl abietate, 312
- Methylabietin, 312
- 2-Methyladenine, 588
- $\beta$ -Methyladipic acid, 254, 268, 269
- 2-Methylaminoguanine, 588
- 6-Methylaminopurine, 588
- Methyl arbutin, 239
- Methylbixin, 337
- Methylcadalene, 301-302
- 20-Methylcholanthrene, 350, 367
- Methylcyclohexane, 111
- 2-Methylcyclohexanol, 112
- 2-Methylcyclohexanone, 112, 334
- 3-Methylcyclohexanone, 269, 270
- 4-Methylcyclohexan-2-one-1-carboxylic ester, 269
- 3-Methylcyclohexylamine, 113
- 1-Methylcyclohexylidene-4-acetic acid, 140
- 1-Methylcyclopropane-1:2:3-tricarboxylic acid, 278
- 5-Methylcytosine, 588, 589
- N*-Methyl-4:5-diamino-*o*-xylene, 605
- 3-Methyl-5:6-dimethoxyanthranil, 435
- 3-Methyl-1:5-diphenylpyrazole, 423
- Methyleneglycine, 461
- Methyl fructoside, 194, 198, 215
- N*-Methylglucosamine, 232, 637, 638
- Methyl glucoside, 184, 187, 190, 197, 199, 200, 202, 206
- $\alpha$ -Methylglutaric acid, 311
- Methylglyoxal, 246, 429
- 1-Methylguanine, 588
- 3-Methylheptane, 48
- Methylheptenone, 247, 248, 254, 265, 327
- Methylisopelletierine, 502
- Methylisopropylacetaldehyde, 383, 385
- 1-Methyl-4-isopropyl-naphthalene, 304
- 7-Methyl-1-isopropyl-naphthalene, 304
- $\beta$ -Methyl- $\alpha$ -isopropyl-pimelic acid, 269
- Methylmorphenol, 539, 540
- $\alpha$ -Methylmorphimethine, 538, 539
- $\beta$ -Methylmorphimethine, 538, 539
- Methylmorphol, 538, 539
- 2-Methyl-1:4-naphthaquinone, 626

- 10-Methylphenoxarsine-2-carboxylic acids, 166  
 Methylphenylmethanol, *see*  
 $\alpha$ -Hydroxyethylbenzene  
 Methylphenylmethyl chloride, *see*  
 $\alpha$ -Chloroethylbenzene  
 3-Methyl-1-phenylpyrazole, 422  
 5-Methyl-1-phenylpyrazole, 422  
 3-Methyl-1-phenylpyrazolone, 426  
 Methylphenyl-*p*-tolyltelluronium iodide, 175  
 3-Methylpyrazolone, 424  
 Methylsuccinic acid, 50  
 Methyl tartrate, 49  
 Methyl tetramethylfructoside, 194  
 Methyl tetramethylglucoside, 188, 189  
 4-Methylthiazole-5-carboxylic acid, 599  
 4-Methyluracil, 573  
 Methylurea, 573, 580, 583, 584  
 Methyluric acid, 572, 573, 584  
 $\beta$ -Methylvaleric acid, 41-42  
 Methylvinylcarbonyl bromide, 253  
 Methyl vinyl ketone, 259, 331  
 7-Methylxanthine, 577  
 Mevalonic acid, 315-316  
 Mezcaline, 492-493  
 Michael condensation, 273, 282, 371, 526  
 Micro-wave spectroscopy, 15  
 Millon's reaction, 466  
 Mirror image forms, 20-21  
 Molecular compounds, 2, 12  
 Molecular overcrowding, 133-135, 138  
 Molecular refractivity, 7-10, 185, 245, 279, 295, 298, 301, 398  
 Molecular rotation, 8-11  
 Molecular volumes, 5-6  
 Molecular weights, 5, 16, 227-228, 229, 231, 466, 595, 664  
 Monastral Fast Blue BS, 663  
 Monosaccharides, 176-208  
 Morphenol, 539, 540  
 Morphine, 52, 537-541  
 Morphol, 538, 540  
 Morpholine, 440, 446  
 Morphothebaine, 538  
 Mozingo reaction, 613  
 Mucic acid, 180  
 Mucilages, 232  
 Murexide, 570  
 Mutarotation, 181-183  
 Mycomycin, 140  
 Mycosterols, 359  
 Myrcene, 245-246, 278  
 Myrosin, 240
- N**
- Naphthacene, 347  
 Naphthalene-2-carboxylic acid, 385  
 2-Naphthol, 118, 354  
 $\gamma$ -1-Naphthyl- $\alpha$ : $\gamma$ -diphenylallene- $\alpha$ -carboxylic acid, 140  
 2-Naphthylphenylphosphoramidic ester, 162  
 Narcotine, 55, 537  
 Nebularine, 576  
 Neighbouring group participation, 74-79, 157, 207, 364  
 Neoaarsphenamine, 631  
 Neobilirubic acid, 656  
 Neopentyl halides, 64-65  
 Neoprene, 320  
 Neosalvarsan, 631  
 Neovitamin a, 334  
 Neovitamin b, 334  
 Neral, *see* Citral-b  
 Nerol, 252-253  
 Nerolidol, 297, 298  
 Neutron crystallography, 17-18  
 Newman projection formula, 26  
 Niacin, *see* Nicotinic acid  
 Nicotinamide, 617  
 Nicotine, 21, 504-509, 617  
 Nicotinic acid, 497, 504-506, 617  
 Nicotone, 508  
 Ninhydrin reaction, 462  
 6-Nitrodiphenic acid, 127  
 Nitrogen compounds, stereochemistry of, 143-161  
 $o$ -Nitrophenylglyoxylic acid, 159  
 $o$ -*N*-Nitroso-*N*-benzoyltoluidine, 427  
 Nitrosolimonene, 262  
 5-Nitrouracil, 573  
 5-Nitrouracil-4-carboxylic acid, 573  
 Noradrenaline, 494  
 Norbixin, 328, 336  
 Norbornyl compounds, 291-292  
 Norcholanic acid, 366  
 Norepinephrine, *see* Noradrenaline  
 Norleucine, 449, 450, 452  
 Nornicotine, 509  
 Norpinic acid, 275-277  
 Novocaine, *see* Procaine  
 Nuclear magnetic resonance, 17-18, 94, 119, 120, 149, 160, 161, 187  
 Nucleic acid, 587, 594-596  
 Nucleophilic substitution, aliphatic, 60-79  
 Nucleoproteins, 587  
 Nucleosides, 587, 589-592  
 Nucleotides, 587, 589, 592-594
- O**
- Ocimene, 246-247  
 Octan-2-ol, 71, 170  
 Estradiols, 402, 404-405  
 Estriol, 401-403  
 Estrogens, 398-409  
 Estrone, 398-401, 402, 415  
 Oil of ambrette, 296  
   bay, 245  
   bergamot, 253  
   camphor, 279  
   caraway, 259  
   celery, 303  
   chenopodium, 266  
   citronella, 254, 255  
   cubebs, 299  
   eucalyptus, 265, 270, 304  
   fennel, 293  
   geranium, 255  
   ginger, 298  
   lemon, 260  
   lemon grass, 247  
   myrrh, 297  
   neroli, 253, 297  
   orange, 253, 262  
   orris root, 252  
   pennyroyal, 269  
   peppermint, 262, 267, 268

- pine needle, 266, 267, 272  
 rose, 252, 253, 255  
 spearmint, 259  
 turpentine, 262, 274, 309  
 verbena, 245  
 Opacity, 14  
 Oppenauer oxidation, 372, 380, 383, 392,  
 397, 410, 411, 412, 414, 417  
 Opsopyrrole, 643, 644  
 Opsopyrrolecarboxylic acid, 645  
 Optical activity, 8, 20-21, 24, 93  
 cause of, 56-58  
 Optical exaltation, 8, 245, 298, 301  
 Optical inversion, *see* Walden inversion  
 Optical isomerism, 20-58  
*see also* Stereochemistry  
 Optical Superposition, Rule of, 9, 186  
 Ornithine, 451, 453  
 Oscine, 517  
 Osmium tetroxide (use of), 97, 99, 364,  
 373, 418  
 Osootriazoles, 433-434  
 Oxadiazoles, 434  
 Oxazines, 446  
 Oxazoles, 430-431  
 Oxazolones, *see* Azlactones  
 Oxidases, 477  
 Oximes, *see* Aldoximes and Ketoximes  
 Oximino compounds, 511, 525  
 Oxonium salts, 5, 552, 560  
 Oxycaffeine, 581-582  
 Oxyhaemoglobin, 643  
 Ozonolysis, 154, 211, 245, 246, 250, 252,  
 253, 254, 255, 287, 296, 298, 301, 303,  
 306, 307, 313, 317, 322, 323, 327, 328,  
 330, 383, 388, 410, 414, 524, 622, 624,  
 625
- P**
- Paludrine, *see* Proguanil  
 Pamaquin, *see* Plasmoquin  
 Pantoic acid, 608-609  
 Pantolactone, 608-609  
 Pantothenic acid, 608-610  
 Papain, 53  
 Papaveraldine, 533, 536  
 Papaverine, 533-536  
 Papaverinic acid, 533, 536  
 Papaverinol, 533, 535  
 Papaveroline, 533  
 Parabanic acid, 571, 572  
 Parachor, 6  
 Paramagnetism, 13  
 Patulin, 639-640  
 Pectin, 232  
 Pelargonidin chloride, 546, 553-554  
 Pelargonin, 553, 554  
 Pelletierine, 502  
 $\psi$ -Pelletierine, 502  
 Penaldic acid, 634, 636  
 Penicillamine, 633-634, 636  
 Penicillins, 632-637  
 Penicilloic acid, 634, 636  
 Penicillic acid, 635, 636  
 Penilloaldehyde, 633, 634, 636  
 Penilloic acid, 634, 636  
 2:3:4:5:6-Penta-acetylaldehydoglucose,  
 183  
 Pentacene, 348  
 Pentan-2-ol, 54  
 Pentosans, 232  
 Pentoses, aldo, 177-179, 192-193  
 Peonidin chloride, 546, 549, 555  
 Peonin, 555-556  
 Peptides, 467, 468  
 Peptones, 467  
 Perbunan, 319  
 Perhydrocarotene, 322, 329  
 Perhydrocrocin, 337  
 Perhydrolycopene, 327  
 Perhydronorbixin, 336, 337  
 Perhydrosqualene, 313  
 Perhydrovitamin A, 330  
 Periodic acid (use of), 198-201, 216, 228,  
 230, 372, 591, 593, 641  
 Perkin reaction, 341, 352, 504  
 Perylene, 353  
 Phæophorbide-a, 657, 661, 662  
 Phæophorbide-b, 657  
 Phæophytin a, 657  
 Phæophytin b, 657  
 Phæoporphyrin-a, 661  
 $\alpha$ - and  $\beta$ -Phellandrenes, 264  
 Phenanthrene, 339-345, 538  
 Phenanthrene derivatives (synthesis of),  
 339-345  
 Phenanthrene-1:7-dicarboxylic acid, 312  
 Phenazine, 446  
 Phenobarbitone, *see* Luminal  
 Phenothiazines, 447  
 Phenoxazines, 446-447  
 Phenylalanine, 434, 450, 452, 454, 455,  
 456, 457, 489  
 Phenyl azide, 433, 436  
 Phenylazomalnonitrile, 441, 578  
 2-Phenylcyclohexanol, 123  
 Phenylcyclohexenes, 123  
 $p$ -Phenylenebisiminocamphor, 54  
 $o$ -Phenylenediamine, 430, 434, 446, 604  
 $N$ - $\alpha$ -Phenylethylacetamide, 157  
 $\beta$ -Phenylethylamine, 489  
 2-Phenylethyl bromide, 344  
 $\alpha$ -Phenylethyl methyl ketoxime, 157  
 2-Phenyl-2- $p$ -hydroxyphenyl-1:2:3:4-  
 tetrahydroisospholinolium  
 bromide, 163  
 10-Phenylphenoxarsine-2-carboxylic acid,  
 166  
 Phenylpropionic acid, 96  
 1-Phenylpyrazole, 425-426  
 1-Phenylpyrazole-4-aldehyde, 426  
 $N$ -Phenyl- $N$ - $p$ -tolylanthranilic acid, 147  
 Phenyl  $p$ -tolyl ketoxime, 150  
 Phloroglucinaldehyde, 551, 552, 555, 556  
 Phloroglucinol, 546, 551, 554, 555, 556,  
 557, 562  
 Phosphoproteins, 467  
 Phosphoranes, 337  
 Phosphorus compounds, stereochemistry  
 of, 161-163, 168-169  
 Photosynthesis, 232-233  
 Phthalazines, 445, 664  
 Phthalocyanines, 662-665  
 Phthalonitrile, 663, 664  
 Phthiocol, 626  
 Phylloerythrin, 661  
 Phylloporphyrin, 658, 660  
 Phyllopyrrole, 643, 658  
 Phyllopyrrolecarboxylic acid, 645

- $\alpha$ -Phylloquinone, *see* Vitamin K<sub>1</sub>  
 Physiological conditions, 314  
 Phytol, 308-309, 622, 624, 653, 661  
 Phytosterols, 359  
 Phytol bromide, 621, 622  
 Picene, 352-353, 358, 412  
 Picolinic acid, 501, 505-506  
 Pimaric acid, 313  
 Pimelic acid, 512, 614  
 Pinane, 273  
 $\alpha$ -Pinene, 49, 274-279, 284, 288  
 $\beta$ - and  $\delta$ -Pinene, 278, 279  
 Pinic acid, 275-276  
 Pinol, 274  
 Pinol glycol, 274  
 Pinol hydrate, 274  
 $\alpha$ -Pinoic acid, 275-277  
 Piperazines, 445  
 Piperic acid, 503-504  
 Piperidine, 486, 503, 504  
 2-Piperidone, 155  
 Piperine, 503-504  
 Piperitone, 270  
 Piperonal, 503, 504, 521  
 Piperonylic acid, 503, 504, 521  
 Plane of symmetry, 37  
 Plant hormones, *see* Auxins  
 Plasmogin, 630  
 Polar bonds (in cyclohexane), 110  
 Polar effects, 61-63  
 Polarizability, 12  
 Polycyclic aromatic hydrocarbons, 8, 339-357  
 Polypeptides, 467, 471-477  
 Polysaccharides, 5, 16, 224-232  
 Porphin, 646-647, 649-650  
 Porphobilinogen, 655  
 Porphyrins, 643, 647-650, 661  
 Pre-ergocalciferol, 384  
 Pregnane, 415  
 Pregnane diol, 413, 414  
 Pregnane dione, 415  
 Pregnane olone, 410, 411, 412, 417  
 Primeverose, 236  
 Procaine, 520  
 Progesterone, 409-414, 415  
 Proguanil, 631  
 Projection formulae, 26, 30-43  
 Prolamines, 466  
 Proline, 450, 451, 452, 466  
 Prontosil, 629  
 Prontosil S, 629  
 Propargylaldehyde, 430  
 Prosthetic group, 467, 477, 479  
 Protamines, 467, 587  
 Proteins, 5, 317, 449, 465-477, 643  
 Proteoses, 467  
 Protocatechuic acid, 493, 503, 521, 538, 546, 551, 562  
 Proton magnetic resonance, 18  
 Protoporphyrin, 645, 653  
 Prunasin, 237  
 Pschorr synthesis, 341, 352, 539  
 Pseudo-asymmetry, 44  
 Psicose, 181  
 Pteridines, 448, 610-611  
 Pterins, 612  
 Pteric acid, 610  
 Pteroylglutamic acid, *see* Vitamin B<sub>6</sub>  
 Pulegone, 269-270  
 Purine, 575-576  
 Purines, 569-587, 588  
 Purpuric acid, 570  
 Pyranose sugars, 182, 187-203  
 Pyrazines, 444-445, 611  
 Pyrazole, 421-423  
 Pyrazoles, 422, 423-426  
 Pyrazole-3:4:5-tricarboxylic acid, 422  
 Pyrazole-3:4:5-tricarboxylic ester, 424  
 Pyrazolidine, 423  
 Pyrazolines, 278, 423, 424, 425, 426  
 Pyrazolones, 424, 427  
 Pyrene, 353  
 Pyrethrosin, 299  
 Pyridazines, 362, 388, 437  
 Pyridine-2:3:4-tricarboxylic acid, 529, 534  
 Pyridoxin, 615-617  
 Pyrimidine, 437, 440, 569  
 Pyrimidines, 438-444, 576, 577, 588-589, 600-602, 603, 611-612, 628  
 Pyrodeoxybilanic acid, 370  
 Pyromellitic acid, 301-302  
 Pyrroporphyrin, 659, 660  
 Pyruvic acid, 81, 141, 261, 603
- Q
- Quasi-racemic compounds, 50-51, 130  
 Quaternary ammonium compounds, 143-146  
 Quercetin, 562-565  
 Quercitrin, 562  
 Quinazolines, 445  
 Quinidine, 54, 55, 530  
 Quinine, 52, 55, 510, 528-532, 609, 630  
 Quinic acid, 529, 530  
 Quininone, 528  
 Quinol, 238  
 Quinoline, 506, 521, 522, 524, 529, 617, 630  
 Quinolinic acid, 506, 617  
 Quinotoxine, 530, 532  
 Quinoxalines, 445, 612  
 Quinuclidine, 526
- R
- (*R*)-compounds, 36  
 $R_F$  value, 457  
 Racemic modification, 45-56  
   resolution of, 51-56  
 Racemisation, 45-48, 166  
 Raffinose, 224  
 Raman spectra, *see* Absorption spectra  
 Rearrangements, 153, 155, 156, 157, 158-159, 240, 249, 250, 253, 260, 263, 284, 288-292, 297, 308, 331, 334, 346, 347, 381, 400, 404, 409, 429, 486, 517, 519, 527, 538, 560, 571, 576, 635  
 Reductive acid, 212  
 Reductones, 212  
 Reformatsky reaction, 81, 248, 282, 294, 300, 305, 333, 401  
 Refractor, 7  
 Refractive index, 7-8  
   *see also* Molecular refractivity  
 Reimer-Tiemann reaction, 456, 504  
 Replacement reactions, 60  
 Residual valencies, 2  
 Resin acids, 309



- Resolution, *see* Racemic modification  
 Resonance, 3, 8, 12, 15, 16, 28, 89, 422, 429, 435, 436, 441, 575, 646, 665  
 Restricted rotation about a single bond, 26-30, 127-139, 155  
 Retene, 309  
 Retinene, 335  
 Rhamnose, 232, 545, 558, 562  
 Rhodinal, 254  
 Rhodinol, 254, 255  
 Rhodoporphyrin, 659  
 Rhodoxanthin, 335  
 Riboflavin, *see* Vitamin B<sub>2</sub>  
 Ribonucleic acid (R.N.A.), 587, 595-596  
 Ribose, 177-179, 587, 590, 592, 594, 606, 607  
 Ribulose, 233  
 Ricinine, 498-499  
 Rosin, 309  
 Rotational isomers, 28  
 Rotatory dispersion, 8, 10-11, 130, 458  
 Rotatory power, 8-10  
 Rubber, 317-320  
 Rubbers, synthetic, 319  
 Ruberythric acid, 236  
 Rubixanthin, 335  
 Rubrene, 348  
 Rubrene peroxide, 348
- S**
- SS-compounds, 36  
 (S<sub>N</sub> reaction, 60  
 S<sub>N</sub>2 reaction, 74  
 Sabinene, 272  
 Sabinol, 272  
 Saccharic acid, 30, 43, 180, 189, 204, 218  
 Sachse-Mohr theory, 116  
 Salicin, 239  
 Salicyl alcohol, 239  
 Salkowski reaction, 359  
 Salvarsan, 631  
 Santonin, 307  
 Sapietic acid, 313  
 Sapogenins, 412  
 Saponins, 412  
 Schmidt reaction, 455  
 Scleroproteins, 466  
 Scopine, 516-517  
 Scopolamine, *see* Hyoscine  
 Scopoline, *see* Oscine  
 Scyllitol, 115  
 Secondary valencies, 2  
 Sedoheptulose, 233  
 Selenium compounds, stereochemistry of, 174-175  
 Selenium dehydrogenations, 245, 252, 301, 307, 309, 330, 342, 344, 345-347, 352, 358, 360, 363, 367, 368, 369, 385, 399, 400, 404, 405, 412, 619  
 Selinenes, 303, 305  
 Semi- $\beta$ -carotenone, 324  
 Senecioic acid, 315  
 Serine, 34, 449, 450, 451, 452  
 Sex hormones, *see* Hormones  
 Shapes of molecules, 143-144  
 Shift, Rule of, 9, 378-379  
 Shikimic acid, 481, 482  
 Silicon compounds, stereochemistry of, 174  
 Silicone rubbers, 320  
 Sinigrin, 240  
 Skew conformation, 27, 110  
 Skraup synthesis, 505, 630  
 Sobrerol, 274  
 Sobrerythritol, 274  
 Sodium borohydride (use of), 372, 308, 515  
 Solubility, 4  
 Solvent effects, 9, 14, 67-69  
 Solvolysis, 65  
 Sommelet reaction, 426  
 Sorbitol, 213  
 Sorbose, 181, 213  
 Sørensen formol titration, 461  
 Specific rotation, 9  
 Spirans, 140-142, 145-146, 156, 163, 165  
 Squalene, 313-314, 316, 389  
 Stachydrine, 497  
 Staggered form, 27  
 Starch, 228-231  
 Stereochemical conventions, 26-28, 30-37, 97, 116-117, 176, 376-378  
 Stereochemistry, 20-175  
 addition reactions, 96-99, 363-364  
 aldoximes and ketoximes, 149-159  
 alkaloids, 490, 494, 495, 514-516, 518, 519, 527, 530  
 allenes, 139-140  
 antimony compounds, 169  
 arsenic compounds, 163-169  
 dianthryls, 130  
 dinaphthyls, 130  
 diphenyls, 126-139  
 dipyrrolyls, 130  
 dipyrrolys, 130  
 diquinolyls, 131  
 elimination reactions, 100-103  
 germanium compounds, 174  
 nitrogen compounds, 143-161  
 olefinic compounds, 87-105  
 phenylpyrroles, 130  
 phosphorus compounds, 161-163, 168-169  
 polynuclear compounds, 133-135  
 reduced ring compounds, 105-124  
 restricted rotation (other than dipheny type), 129-138, 155  
 selenium compounds, 174-175  
 silicon compounds, 174  
 spirans, 140-142  
 steroids, 376-381  
 sugars, 176-187  
 sulphur compounds, 169-173  
 tellurium compounds, 175  
 terpenes, 267-268, 269, 278, 283, 284, 285, 288-293  
 terphenyls, 132-133  
 tin compounds, 174  
*see also* Geometrical isomerism  
 Stereoisomers, numbers of, 40-45  
 Stereomutation of geometrical isomers, 103-105  
 Steric acceleration, 64, 121  
 Steric control of asymmetric induction, rule of, 84  
 Steric factor, 3, 63-65  
 Steric hindrance, 2, 3, 63-65, 121, 124, 127-139, 226, 469, 567  
 Steric repulsion, 29, 63, 110-112  
 Steric strain, 30, 63, 110-112, 133-135

- Steroids, 358-418  
   stereochemistry of, 376-382  
 Sterols, 358-376, 382-384  
 Stigmastanol, 388  
 Stigmasterol, 359, 387, 410, 417  
 Stilbene, 104  
 Stilbene dibromide, 101  
 Stilbæstrol, 408-409  
 Stobbe condensation, 343  
 Strainless rings, 109-124  
 Strecker synthesis, 450  
 Streptamine, 638  
 Streptidine, 638  
 Streptobiosamine, 638  
 Streptomycin, 637-638  
 Streptose, 637  
 Styrene, 48, 319  
 Styrene dibromide, 48  
 Suberone, 513  
 Substances, F, H, M, Q, S, 416  
 Substrates, 477  
 Succinaldehyde, 514, 519  
 Succinic acid, 87, 94, 245, 298, 317, 343, 649, 651  
 Succinic anhydride, 341-343, 350  
 Sucrose, 215-217, 224  
 Sugars, 53, 176-208, 214-224, 317  
 Sulphadiazine (Sulphapyrimidine), 628  
 Sulphaguanidine, 629  
 Sulphamezathine, 628  
 Sulphanilamide, 627-629  
 Sulphapyridine, 628  
 Sulphathiazole, 628  
 Sulphilimines, 172  
 Sulphinic esters, 170-171, 173  
 Sulphonamides, 627-629  
 Sulphonium salts, 72, 169-170, 173  
 Sulphoraphen, 172  
 Sulphoxides, 171-173  
 Sulphur compounds, stereochemistry of, 169-173  
 Sulphur dehydrogenations, 245, 300, 303, 304, 305, 307, 309, 312, 340, 345-347, 353  
 Surface tension, 6-7  
 Sydnones, 434-436, 461  
 Sylvestrene, 266-267, 272  
 Symmetry, elements of, 37-39  
*Syn*-compounds, 151  
 Syringic acid, 556
- T**
- Tachysterol, 384, 385  
 Tagatose, 181  
 Talomucic acid, 180  
 Talose, 179-180  
 Tannins, 558, 567  
 Tartaric acid, 32-37, 43, 51, 52, 54, 87, 97, 99, 176, 210, 490, 494, 501, 503, 508  
 Tartaric acid dinitrate, 428  
 D-Tartramid acid hydrazide, 53  
 Taurine, 390  
 Taurocholic acid, 390  
 Tautomerism, 7, 15, 16, 18, 45-47, 54, 150, 209, 250, 327, 354, 422, 423, 427, 428, 430, 431, 433, 436, 439, 446, 561, 563, 569, 570, 572, 573, 574, 576, 582, 588, 611, 644, 645  
 Tellurium compounds, stereochemistry of, 175  
 Terebic acid, 256, 257  
 Terpenes, introduction, 242-245  
   diterpenes, 242, 308-313  
   monoterpenes, 242, 243-245, 245-294  
   polyterpenes, 242, 317-319  
   sesquiterpenes, 242, 243, 244, 295-307  
   triterpenes, 242, 313  
 Terpenylic acid, 256-257, 258, 274  
 Terphenyl compounds, 132  
 1:4-Terpin, 264, 266  
 1:8-Terpin, 263-264, 265  
 $\alpha$ -,  $\beta$ , and  $\gamma$ -Terpinenes, 264, 266  
 $\alpha$ -Terpineol, 253, 256-259, 260, 262, 264, 274, 275  
 $\beta$ - and  $\gamma$ -Terpineols, 259  
 Terpin hydrate, 264  
 Terpinolene, 264  
 Terramycin, 638  
 Testosterone, 396-398  
 1:1:3:3-Tetraethoxypropane, 422  
 Tetrahedral carbon atom, 21-26  
 Tetrahydroabietic acid, 311  
 $\alpha$ -Tetralone, 340  
 1:2:3:4-Tetramethylcyclobutane, 38  
 1:3:4:5-Tetramethylfructose, 194  
 1:3:4:6-Tetramethylfructose, 195, 215, 224  
 2:3:4:6-Tetramethylgalactose, 222, 224  
 2:3:4:5-Tetramethylgluconic acid, 189, 223  
 2:3:5:6-Tetramethylgluconic acid, 190, 220, 222  
 2:3:4:6-Tetramethylgluconolactone, 188  
 2:3:4:6-Tetramethylglucose, 183, 187-189, 204, 215, 218, 220, 221, 223, 227, 228, 229, 230, 234, 235, 238, 239  
 2:3:5:6-Tetramethylglucose, 190, 204  
 Tetramethylspiro-(1:1')-dipyrrolidinium *p*-toluenesulphonate, 39, 146  
 1:1':3':5'-Tetraphenyl-3:5'-dipyrzolyli, 423  
 1:1':5:5'-Tetraphenyl-3:3'-dipyrzolyli, 423  
 Tetramethylthiuram disulphide, 319  
 Tetramethyluric acid, 581, 582  
 Tetrazines, 447  
 Tetrazoles, 436  
 Tetroses, 176-177  
 Thebaine, 537-541  
 Thebenine, 538  
 Theobromine, 583-585  
 Theophylline, 583, 585-586, 590  
 Thiamine, *see* Vitamin B<sub>1</sub>  
 Thianthren dioxide, 172  
 Thiazole, 431-432  
 Thiazoles, 431-432  
 Thiazolidines, 432, 634  
 Thiazolines, 432, 633  
 $\delta$ -(2-Thienyl)-valeric acid, 614  
 Thioamides, 431, 432, 600  
 Thiochrome, 603-604  
 Thioglucose, 240  
 Thiohydantoins, 461, 475  
 Thionuric acid, 440  
 Thioureas, 431, 441, 442, 443, 578  
 Thorpe reaction, 407  
 Three-centre reaction, 72  
 Threo-3-bromobutan-2-ol, 76  
 Threonic acid, 210  
 Threonine, 449, 452, 459  
 Threose, 176-177, 210  
 Thujane, 271

- $\alpha$ -Thujene, 272  
 Thujone, 272  
 Thujyl alcohol, 272  
 Thymidine, 589  
 Thymine, 443, 589, 595  
 Thyronine, 462  
 Thyroxine, 452, 462-465  
 Tiglic acid, 135  
 Tin compounds, stereochemistry of, 174  
 $\alpha$ -Tocopherol, 619-622  
 $\beta$ -Tocopherol, 619, 622  
 $\gamma$ -Tocopherol, 619, 622-623  
 $\delta$ -Tocopherol, 623  
 Tolan, 96  
*o*-Toluenediazohydroxide, 427  
 Tosyl esters, 206-207, 396  
 TPN, 598  
*Trans*-addition, 96-99  
 Transaminases, 477, 481  
 Transition temperature, 51  
 Transmittance, 14  
 Transoid form, 27  
 Traube synthesis, 574, 576, 578, 580, 583, 585  
 Trehalose, 218  
 $\omega$ :3:4-Triacetoxyacetophenone, 549  
 $\omega$ :3:4-Triacetoxy-5-methoxyacetophenone, 550  
 Triazines, 447  
 Triazoles, 433-434  
 Trichlorocrotonic acid, 92  
 2:6:8-Trichloropurine, 576, 577, 578, 579  
 Trigonelline, 497  
 Trihydroxycoprostanic acid, 394  
 Trihydroxyglutaric acid, 43, 177, 178, 179  
 $\omega$ :3:4-Trimethoxyacetophenone, 550, 551  
 2:3:4-Trimethylarabinolactone, 193, 194  
 2:3:5-Trimethylarabinolactone, 193, 195  
 2:3:4-Trimethylarabinose, 192  
 2:3:5-Trimethylarabinose, 193  
 3:4:6-Trimethylfructose, 232  
 3:4:5-Trimethylfructuronic acid, 194  
 3:4:6-Trimethylfructuronic acid, 195  
 2:3:4-Trimethylglucose, 218, 222, 223, 224  
 2:3:6-Trimethylglucose, 218-219, 221, 225, 228, 230  
 3:5:6-Trimethylglucose, 204  
 Trimethylisalloxazine, 605  
 1:2:6-Trimethylnaphthalene, 252  
 4:5:8-Trimethyl-1-phenanthrylacetic acid, 133  
 Trimethylphenylarsonium iodide, 164  
 $\beta$ : $\beta$ : $\gamma$ -Trimethylpimelic acid, 252  
 Trimethylquinol, 621, 622  
 Trimethylsuccinic acid, 230  
 Trimethylthreonamide, 210, 211  
 $\alpha$ : $\alpha$ : $\beta$ -Trimethyltricarballic acid, 280  
 Trimethyluric acid, 581, 582, 583  
 2:4:6-Trinitrostilbene, 85  
 Triphenylisoxazole, 154  
 Triphenylmethyl chloride, 206  
 Trisaccharides, 223-224  
 Tri-*o*-thymotide, 55  
 Trityl ethers, 206, 223  
 Tröger's base, 149  
 Tropacocaine, 520  
 Tropane, 511  
 Tropic acid, 516  
 $\psi$ -Tropine, 516  
 Tropic acid, 509-510, 516  
 Tropilidene, 512, 513  
 Tropine, 509, 510-516  
 $\psi$ -Tropine, 514-516, 520  
 Tropic acid, 511, 512, 517, 518  
 Tropinone, 511, 512, 513, 514, 515, 517, 518, 519  
 Truxillic acid, 107-108  
 Truxinic acid, 107, 108  
 Truxone, 108  
 Truxonic acid, 108  
 Tryparsamide, 632  
 Tryptophan, 451, 452, 456  
 Tyramine, 491  
 Tyrosine, 450, 452, 454, 456, 457, 464, 491,

## U

- Ullmann synthesis, 126, 339-340, 354, 463, 464  
 Ultracentrifuge measurements, 228, 317, 466, 595  
 Ultraviolet absorption spectra, *see* Absorption spectra  
 Umbellulone, 272  
 Unimolecular mechanism, 60  
 Uracil, 442-443, 588, 595  
 Uramil, 440, 570, 574  
 Urea, 438, 439, 442, 443, 478, 569, 570, 571, 572, 573, 574, 575, 579, 586, 604, 617, 663  
 Ureides, 438  
   cyclic, *see* Pyrimidines, Purines  
 Uric acid, 569-575, 583, 584, 585  
 $\psi$ -Uric acid, 573-574  
 Uridine, 589  
 Uridylic acid, 589, 593  
 Uronic acids, 232  
 Uroporphyrinogen, 655

## V

- Valeric acid, 79  
 Valine, 449, 450, 451, 452, 454, 455  
 van der Waals forces, 1-2  
 van der Waals radii, 2, 128  
 van Slyke method, 459  
 Veratraldehyde, 522, 563  
 Veratric acid, 493, 521, 533, 550, 562, 563  
 Veratrole, 533  
 Veronal, *see* Barbitone  
 Vetivone, 307  
 3-Vinylquinuclidine, 526  
 Violuric acid, 439, 570, 574  
 Viscosity, 5  
 Vitamins, 598-626  
 Vitamin A<sub>1</sub>, 330-334, 335  
   A<sub>2</sub>, 335  
   B complex, 598-619  
   B<sub>1</sub>, 599-603  
   B<sub>2</sub>, 604-608  
   B<sub>3</sub>, B<sub>4</sub>, B<sub>5</sub>, 619  
   B<sub>6</sub>, *see* Pyridoxin  
   B<sub>10</sub>, B<sub>11</sub>, 610, 619  
   B<sub>12</sub>, 617-619  
   B<sub>13</sub>, B<sub>14</sub>, 619  
   E<sub>c</sub>, 610  
   C, *see* Ascorbic acid  
   D<sub>1</sub> and D<sub>2</sub>, *see* Calciferol  
   D<sub>3</sub>, D<sub>4</sub>, 386-387  
   E group, *see* Tocopherols

Vitamin H, *see* Biotins  
 K<sub>1</sub>, 623-625  
 K<sub>2</sub>, 626-626  
 M, 610  
 Volatility, 3  
 Vulcanisation, 318

## W

Wagner rearrangement, 287  
 Wagner-Meerwein rearrangement, 284,  
 288-292, 294, 312  
 Walden inversion, 69-74, 98, 234-235  
 Wave-mechanical effect, 2  
 Weerman test, 204, 211  
 Wittig reaction, 337  
 Wolff-Kishner reduction, 119, 279, 398,  
 644

## X

X-ray analysis, 3, 16-17, 21, 25, 30, 32, 51,  
 58, 94, 127, 134, 135, 166, 168, 184,  
 185, 198, 216, 226, 232, 318, 358, 360,  
 367, 376, 377, 378, 386, 398, 401, 408,  
 409, 466, 468, 469, 470, 589, 592,  
 595, 618, 635, 641, 646, 664, 665

Xanthine, 579  
 Xanthophylls, 321, 335, 656  
 Xanthoproteic reaction, 466  
 Xanthopterin, 612  
 Xanthosine, 590  
 Xylans, 232  
*p*-Xylenol, 622  
 Xylo-glucans, 232  
*o*-Xyloquinol, 623  
*p*-Xyloquinol, 622  
 Xylose, 177-179, 182, 188, 232, 236  
 Xylotrimethoxyglutaric acid, 188

## Z

Zeaxanthin, 336  
 Zeisel method, 188, 485, 521, 522, 528, 533,  
 537, 546, 555  
 Zerewitinoff active hydrogen determina-  
 tion, 484, 606, 608, 615  
 Zinc dust distillation, 349, 398, 402, 488,  
 499, 501, 510, 538  
 Zingiberene, 298-299  
 Zoosterols, 359  
 Zwitterion, 460  
 Zymase, 237  
 Zymogens, 479

